



US00D791339S

(12) **United States Design Patent** (10) **Patent No.:** **US D791,339 S**  
**Snyder et al.** (45) **Date of Patent:** **\*\* Jul. 4, 2017**

(54) **FLUID FLOW SINKER AND A FLUID FLOW SINKER ASSEMBLY**

(71) Applicant: **SAINT-GOBAIN PERFORMANCE PLASTICS CORPORATION**, Aurora, OH (US)

(72) Inventors: **Mitchell L. Snyder**, Midland, MI (US); **Thomas R. Nixon**, Au Gres, MI (US)

(73) Assignee: **Saint-Gobain Performance Plastics Corporation**, Aurora, OH (US)

(\*) Notice: This patent is subject to a terminal disclaimer.

(\*\*) Term: **14 Years**

(21) Appl. No.: **29/493,502**

(22) Filed: **Jun. 10, 2014**

**Related U.S. Application Data**

(63) Continuation-in-part of application No. 29/478,106, filed on Dec. 31, 2013, now Pat. No. Des. 741,495.

(51) **LOC (10) Cl.** ..... **24-99**

(52) **U.S. Cl.**  
USPC ..... **D24/232**

(58) **Field of Classification Search**  
USPC ..... D24/176-178, 108, 112; D7/300.2; 222/464.4; 166/105.5; D23/258; 433/31, 90-92, 95-96; 604/246  
(Continued)

(56) **References Cited**

**U.S. PATENT DOCUMENTS**

1,581,508 A 5/1922 Bohmard  
RE26,470 E 10/1968 Deuschle et al.  
(Continued)

**FOREIGN PATENT DOCUMENTS**

EP 1477194 A2 11/2004  
EP 1253863 B1 9/2007  
(Continued)

**OTHER PUBLICATIONS**

International Search Report from PCT/US2015/027499 dated Aug. 7, 2015, 1 pg.

*Primary Examiner* — Wan Laymon

(74) *Attorney, Agent, or Firm* — Chi Suk Kim; Abel Law Group, LLP

(57) **CLAIM**

The ornamental design for a fluid flow sinker and a fluid flow sinker assembly, as shown and described.

**DESCRIPTION**

FIG. 1 is a bottom perspective view of a fluid flow sinker and a fluid flow sinker assembly with the fluid flow sinker assembly removed for ease of illustration; FIG. 2 is a side elevation view thereof, the opposite side being a mirror image thereof; FIG. 3 is a top view thereof; FIG. 4 is a bottom view thereof; FIG. 5 is a bottom perspective view of a fluid flow sinker and a fluid flow sinker assembly; FIG. 6 is a side elevation view thereof, the opposite side being a mirror image thereof; FIG. 7 is a top view thereof; FIG. 8 is a bottom view thereof; FIG. 9 is a bottom perspective view of a fluid flow sinker and a fluid flow sinker assembly with the fluid flow sinker assembly removed for ease of illustration; FIG. 10 is a side elevation view thereof, the opposite side being a mirror image thereof; FIG. 11 is a bottom view thereof; FIG. 12 is a bottom view of a fluid flow sinker and the fluid flow sinker assembly; FIG. 13 is a bottom perspective view thereof;

(Continued)

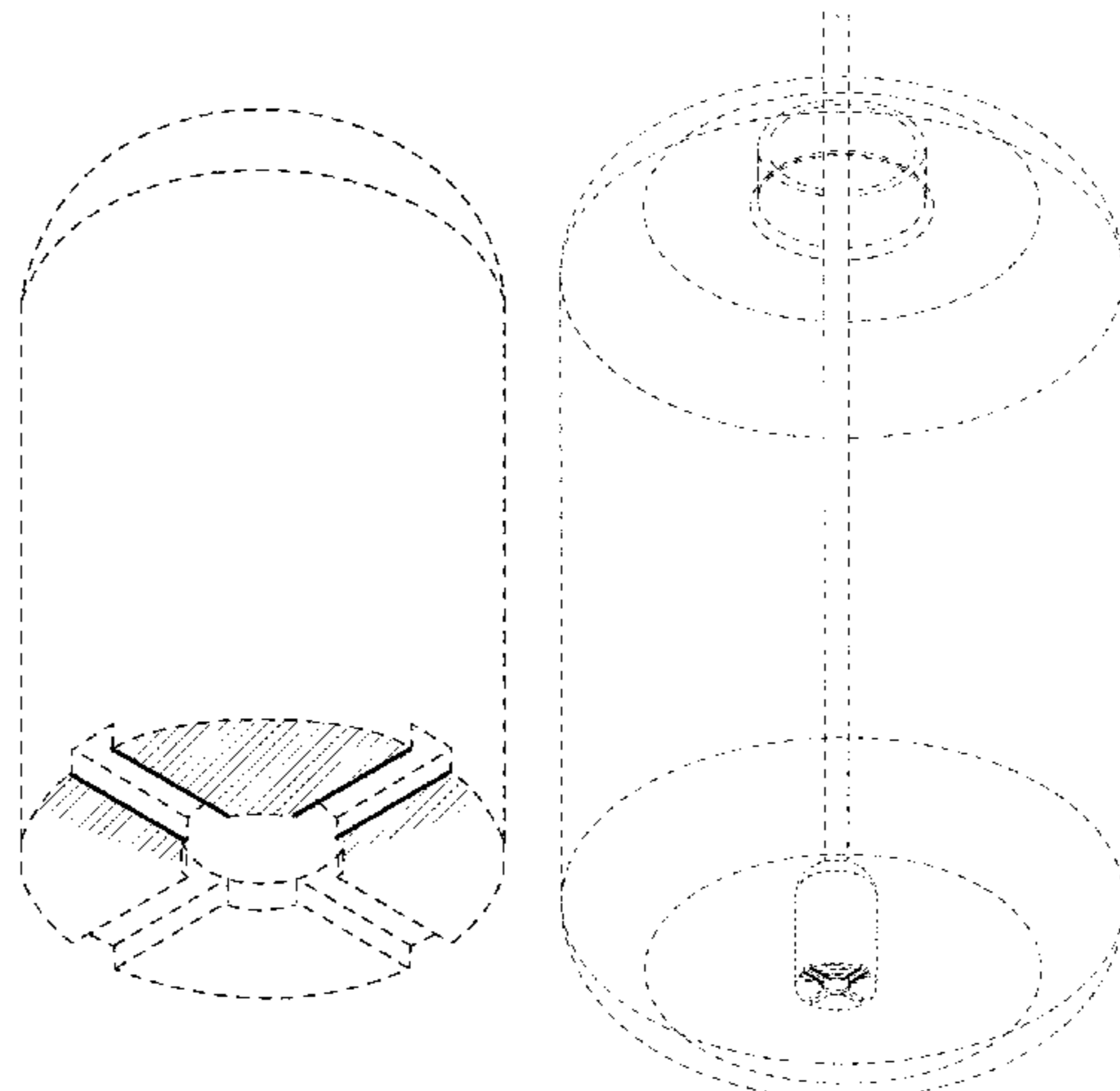

FIG. 14 is a side elevation view thereof; the opposite side being a mirror image thereof;  
 FIG. 15 is a bottom perspective view of a fluid flow sinker and a fluid flow sinker assembly with the fluid flow sinker assembly removed for ease of illustration;  
 FIG. 16 is a side elevation view thereof, the opposite side being a mirror image thereof;  
 FIG. 17 is a bottom view thereof;  
 FIG. 18 is a bottom view thereof;  
 FIG. 19 is a bottom perspective view thereof; and,  
 FIG. 20 is a side elevation view thereof, the opposite side being a mirror image thereof.  
 The broken lines shown in the figures are included for the purpose of illustrating portions of the fluid flow sinker and a fluid flow sinker assembly and form no part of the claimed design.

**1 Claim, 16 Drawing Sheets**

(58) **Field of Classification Search**

CPC ..... A61C 17/043; A61C 17/0208; A61C 17/0202; A61C 17/046; A61C 1/0061; A61C 1/0084; A61C 1/052; Y10S 604/902; A61M 1/008; A61M 3/0279; A61M 1/0058; A61M 1/0023; A61M 16/0488; A61M 1/0039; A61M 3/0258

See application file for complete search history.

(56) **References Cited**

U.S. PATENT DOCUMENTS

3,541,583 A 11/1970 Deuschle  
 4,537,334 A 8/1985 Spengler et al.

5,114,342 A \* 5/1992 Young et al. .... 433/95  
 5,217,044 A 6/1993 Schulte  
 D379,854 S \* 6/1997 Hirsch et al. .... D24/112  
 5,690,487 A \* 11/1997 Whitehouse et al. .... 433/91  
 5,743,736 A 4/1998 Folko et al.  
 5,931,670 A \* 8/1999 Davis ..... 433/91  
 6,156,004 A 12/2000 Tremaine et al.  
 6,183,254 B1 \* 2/2001 Cohen ..... 433/92  
 6,193,101 B1 2/2001 Murphy et al.  
 6,375,092 B1 4/2002 Banach  
 6,602,072 B2 \* 8/2003 Burney ..... 433/96  
 6,821,118 B2 \* 11/2004 Schlusel ..... 433/96  
 6,969,046 B2 11/2005 Streutker et al.  
 7,240,810 B2 7/2007 Harrity et al.  
 7,335,023 B2 2/2008 Mahlmann  
 7,377,780 B2 5/2008 White et al.  
 7,648,083 B2 1/2010 Hornsby et al.  
 7,942,873 B2 5/2011 Kwan et al.  
 8,191,740 B2 6/2012 Hoss et al.  
 D692,143 S 10/2013 shahidi Bonjar  
 8,545,401 B2 10/2013 Hajarian et al.  
 8,603,049 B2 12/2013 Morris et al.  
 8,870,568 B1 \* 10/2014 Ream ..... 433/93  
 2003/0134254 A1 7/2003 Filho  
 2006/0088800 A1 \* 4/2006 Neff et al. .... 433/91  
 2006/0259014 A1 11/2006 Yarger  
 2008/0145815 A1 6/2008 Hershey et al.  
 2012/0001112 A1 1/2012 Alkemade et al.

FOREIGN PATENT DOCUMENTS

JP 11-180481 A 7/1999  
 JP 2002-019862 A 1/2002  
 JP 2005-145457 A 6/2005  
 WO 2013063457 A1 5/2013

\* cited by examiner

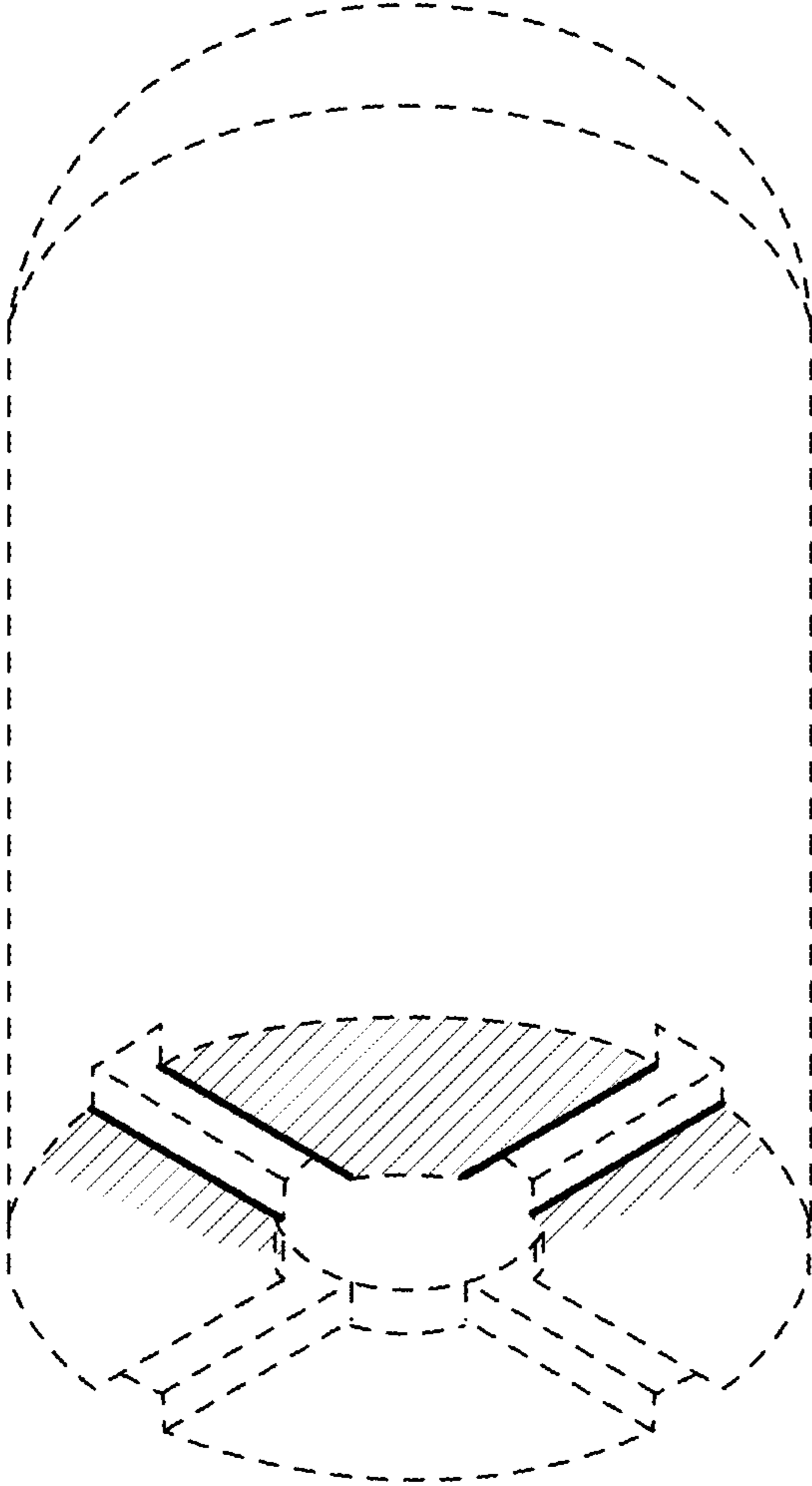

FIG. 1

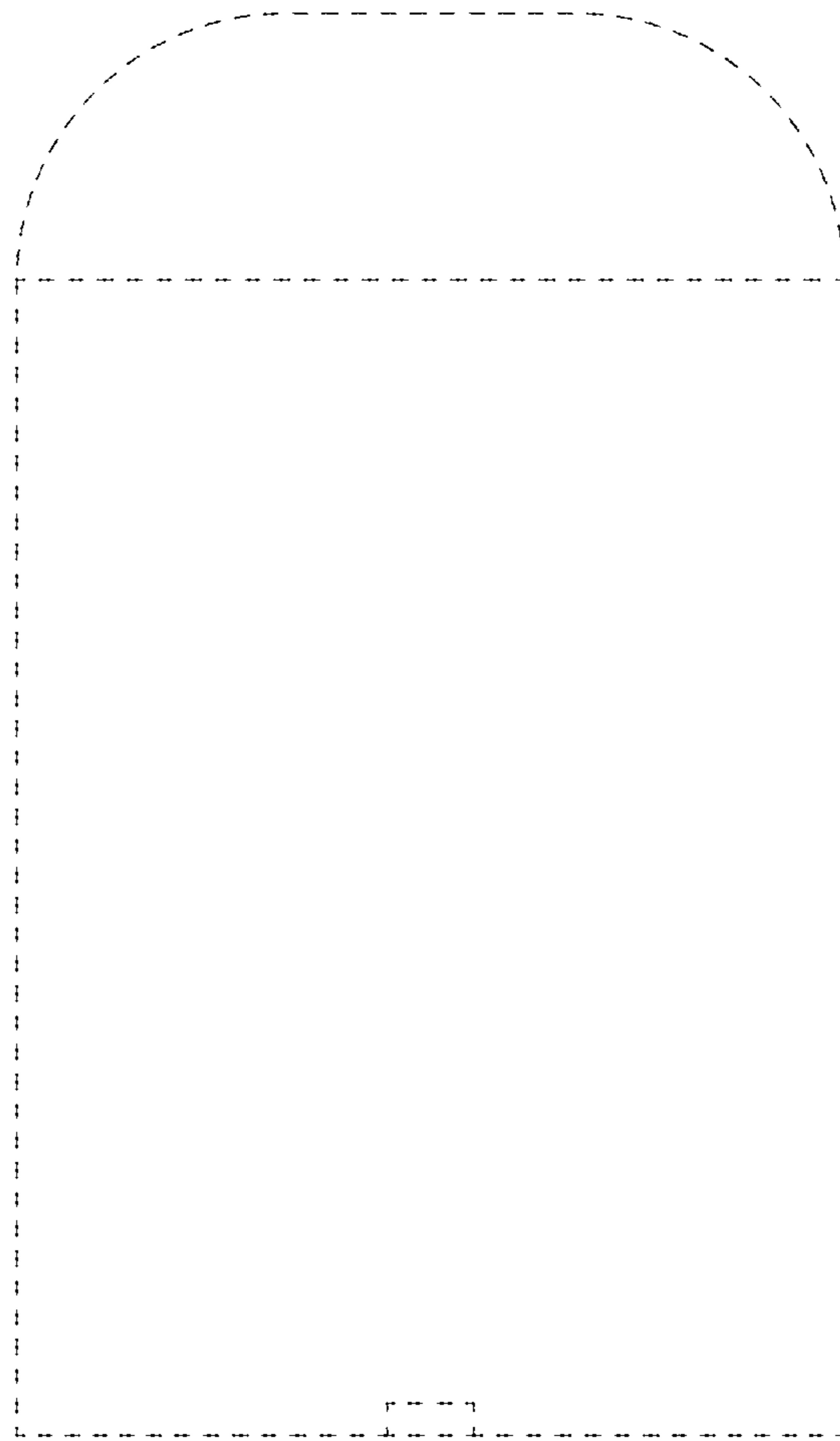

FIG. 2

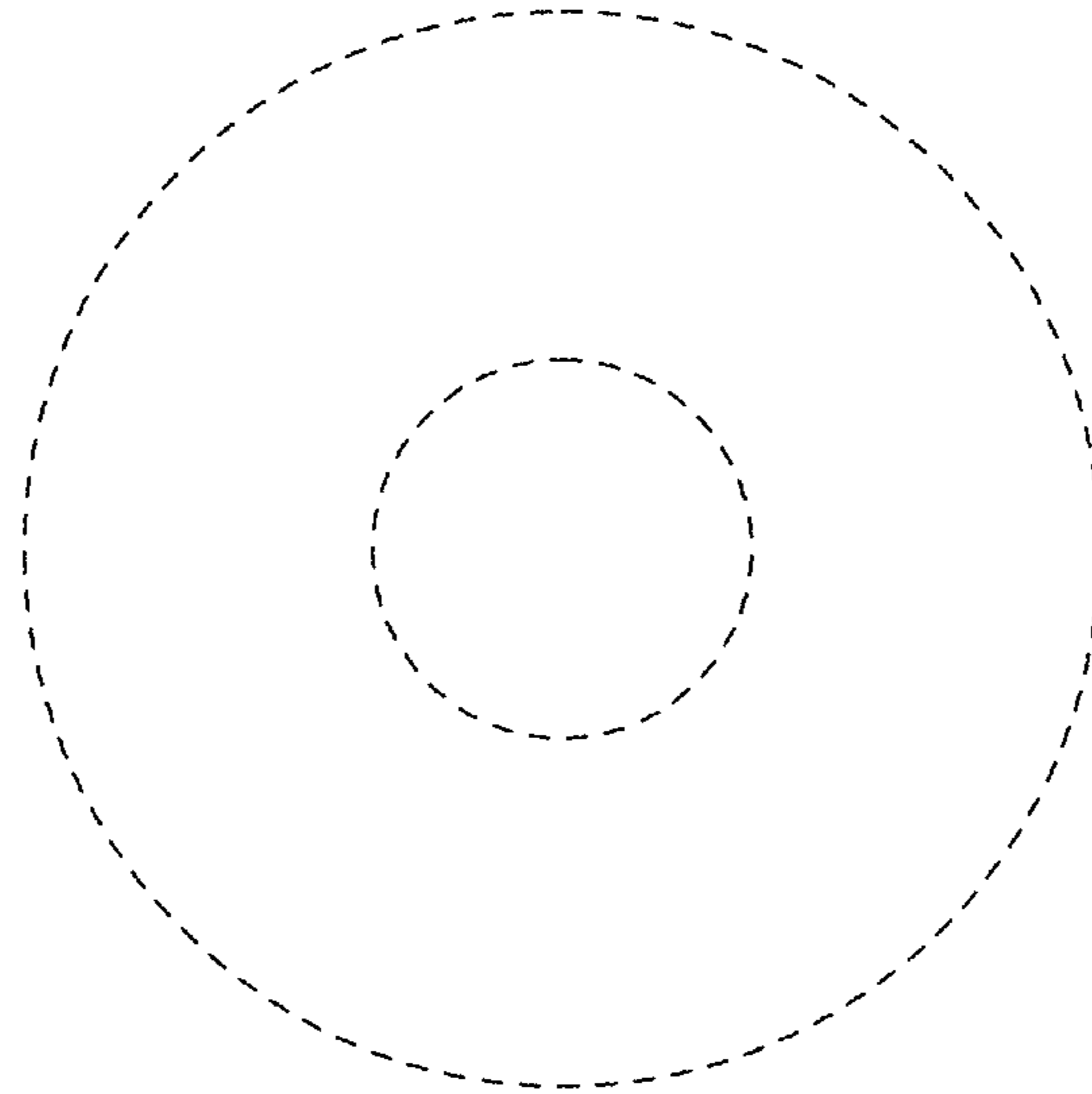

FIG. 3

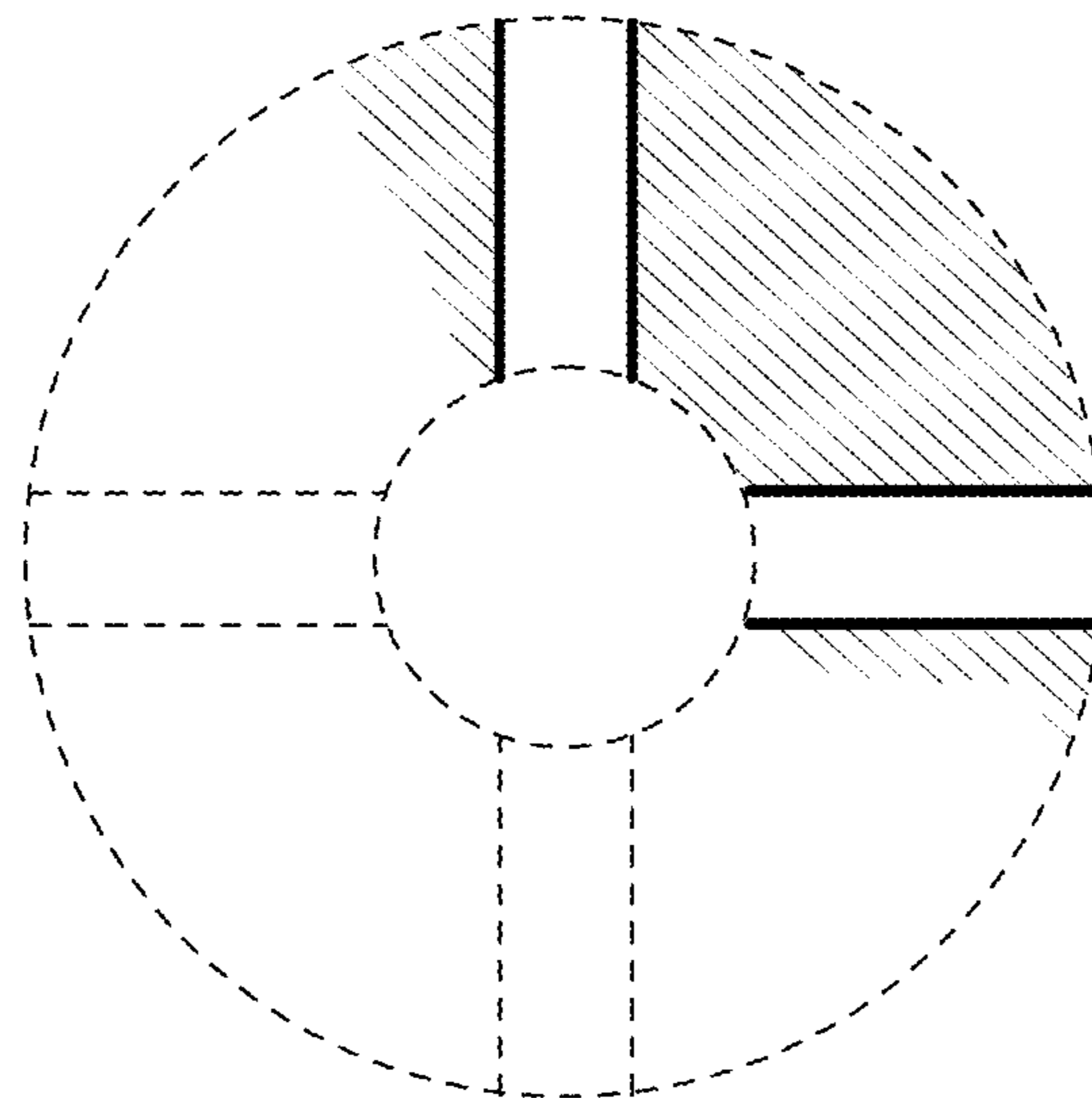
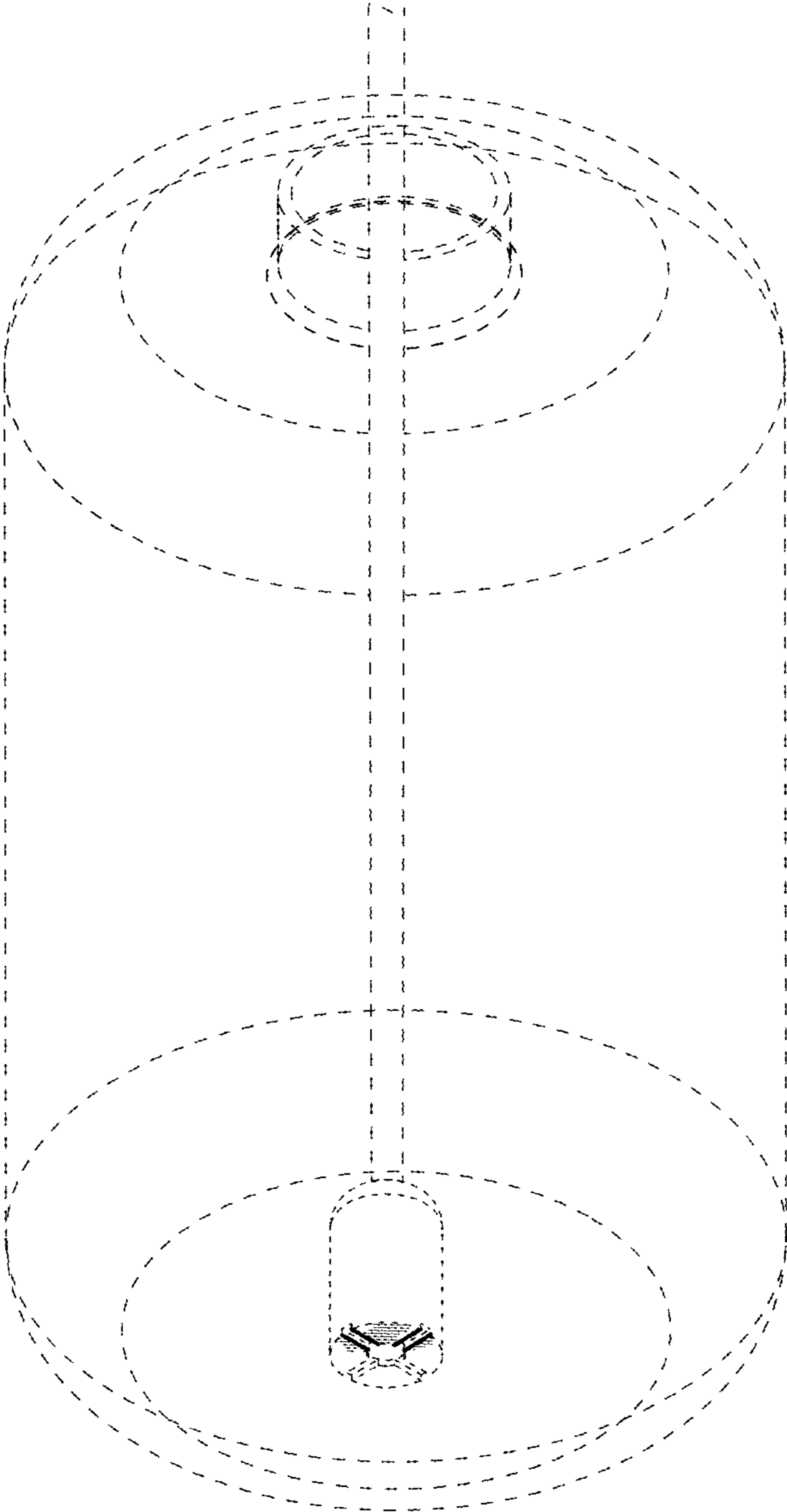

FIG. 4



**FIG. 5**

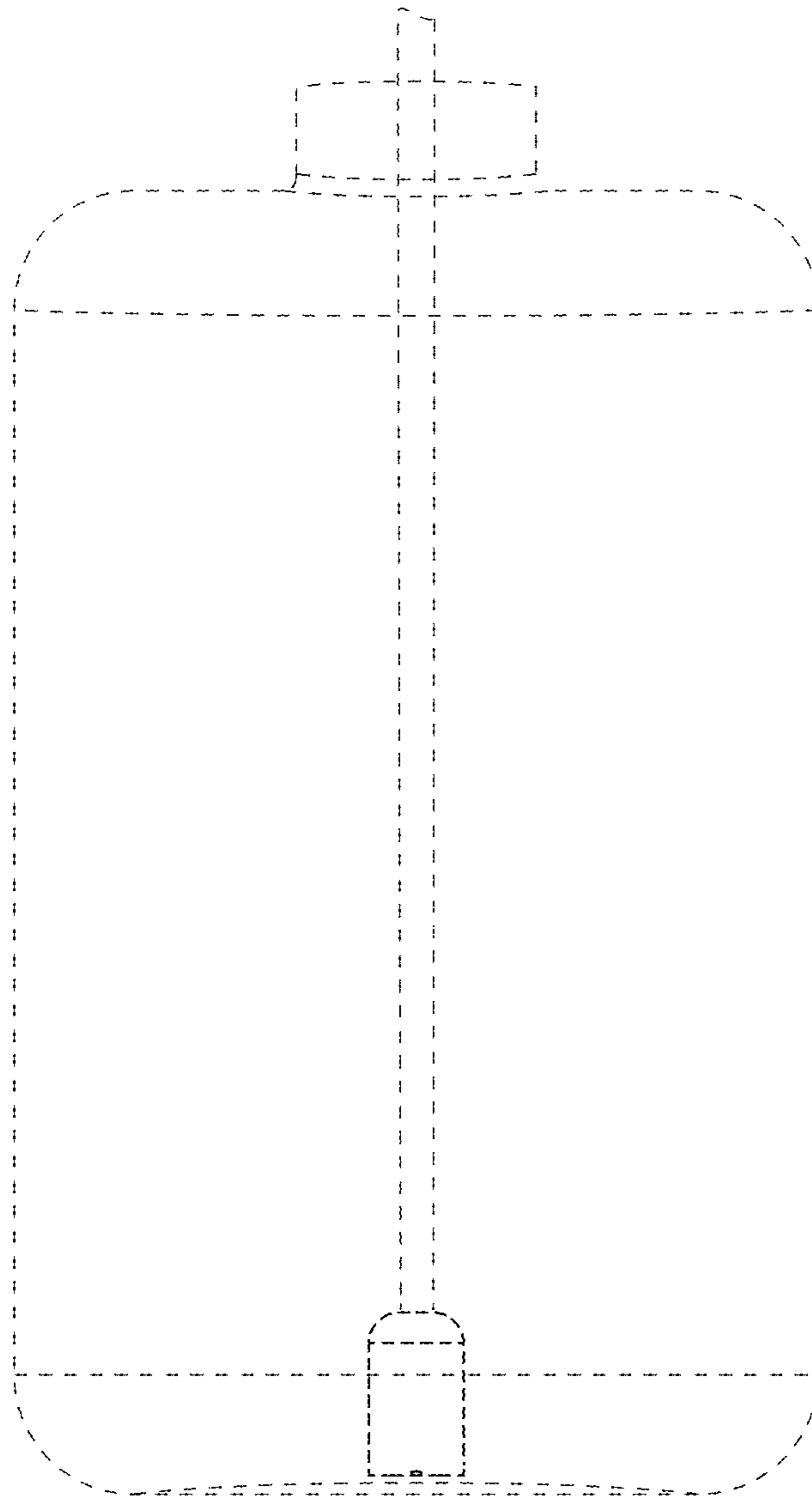
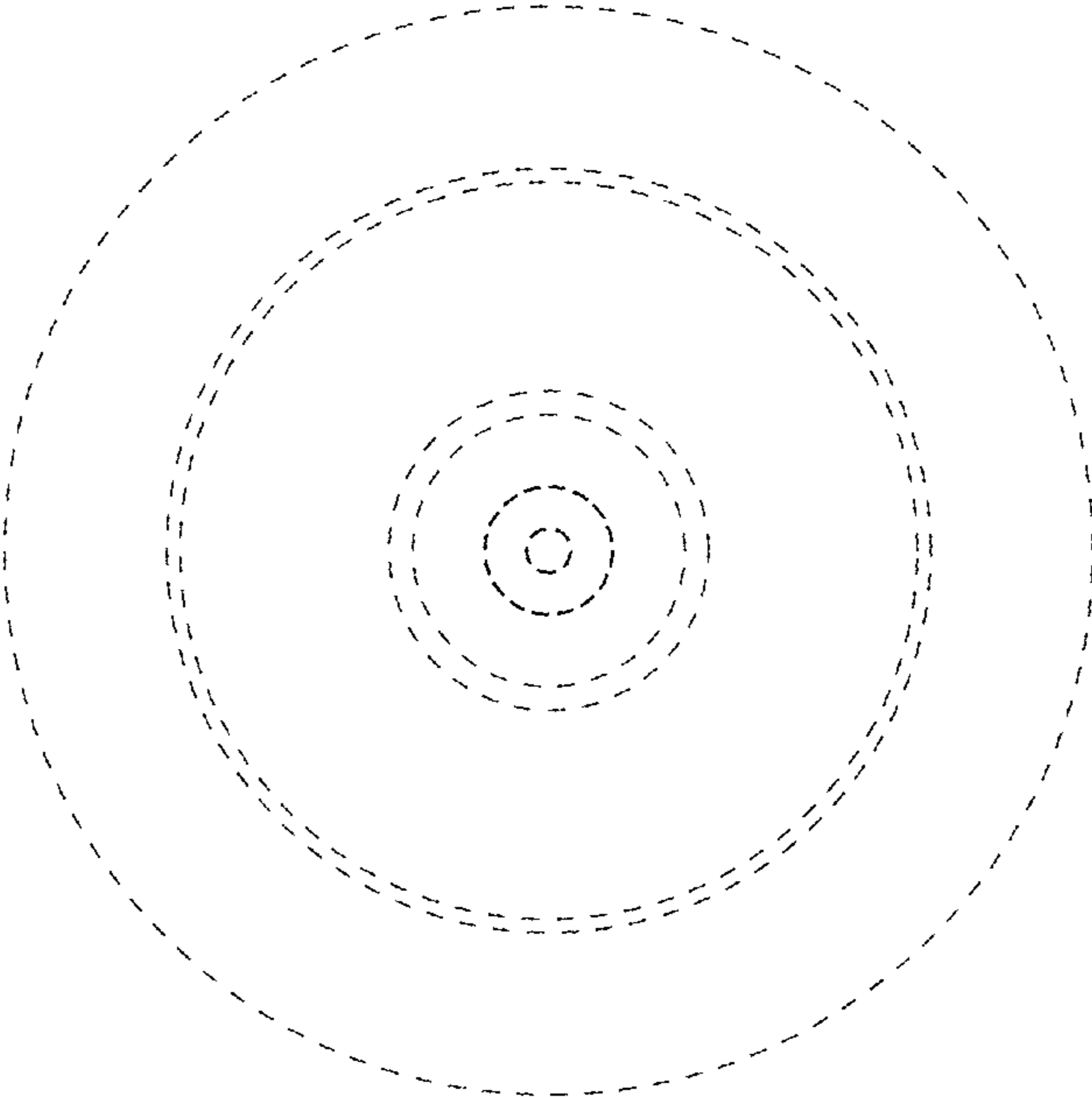
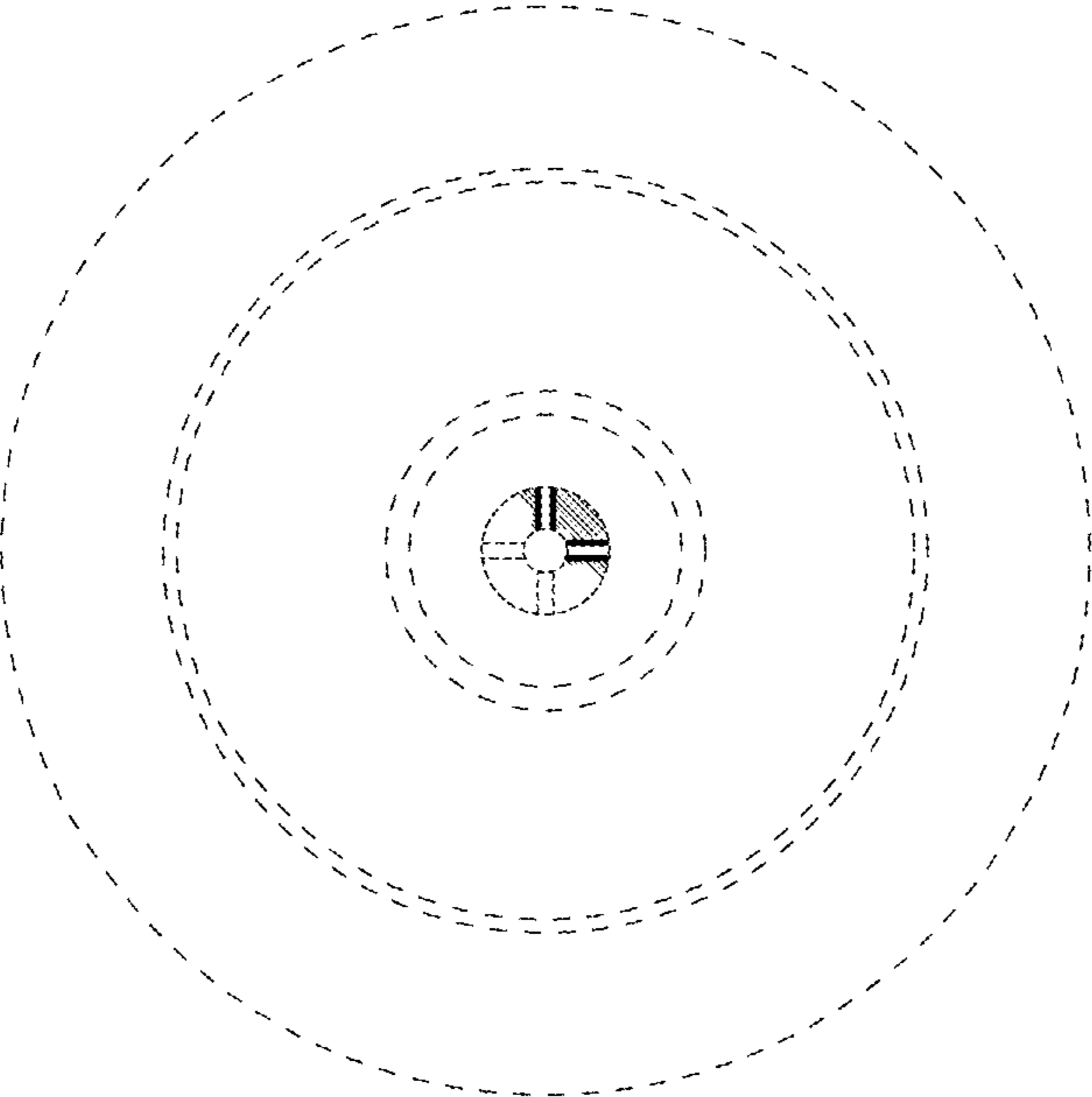

FIG. 6



**FIG. 7**



**FIG. 8**



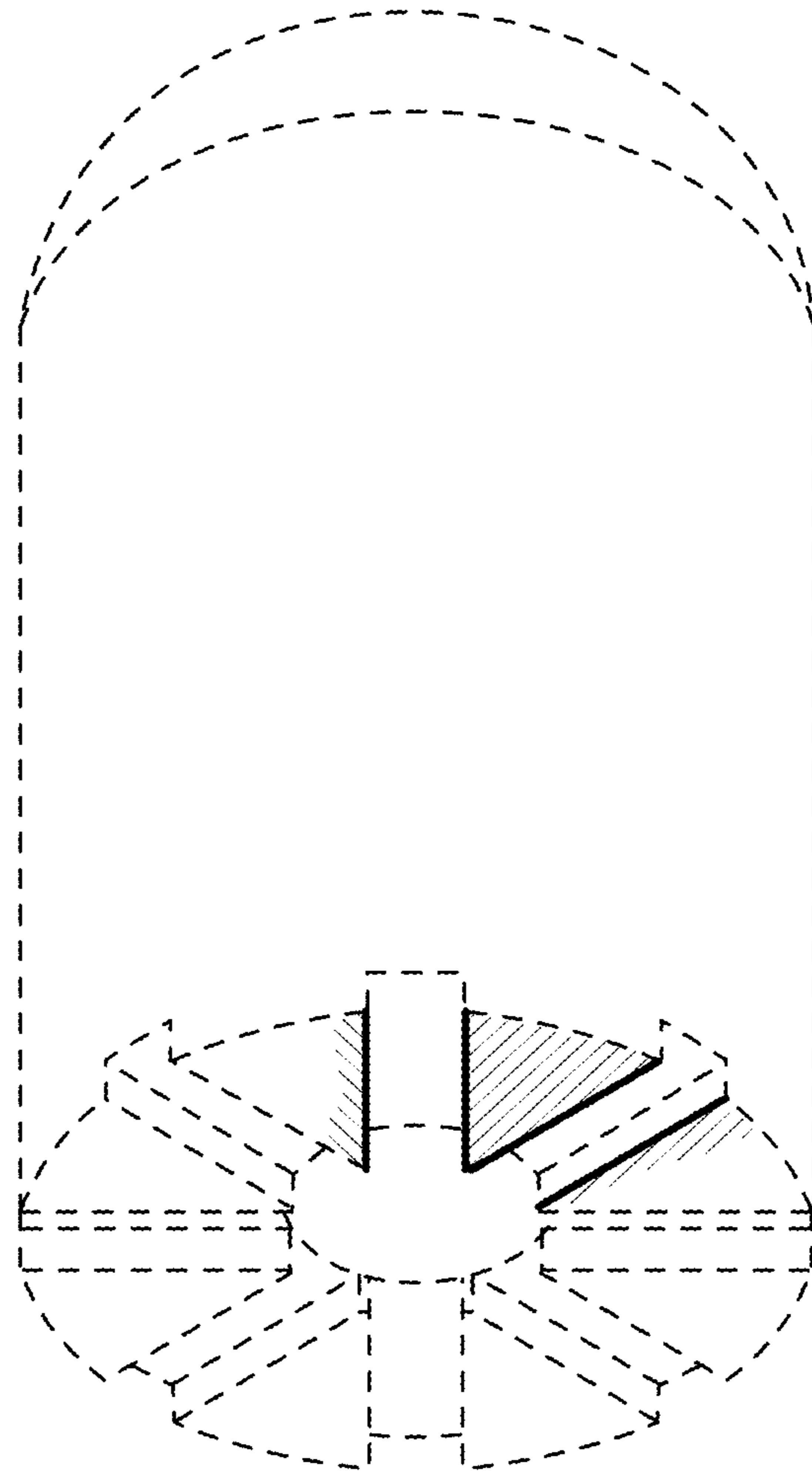

FIG. 9

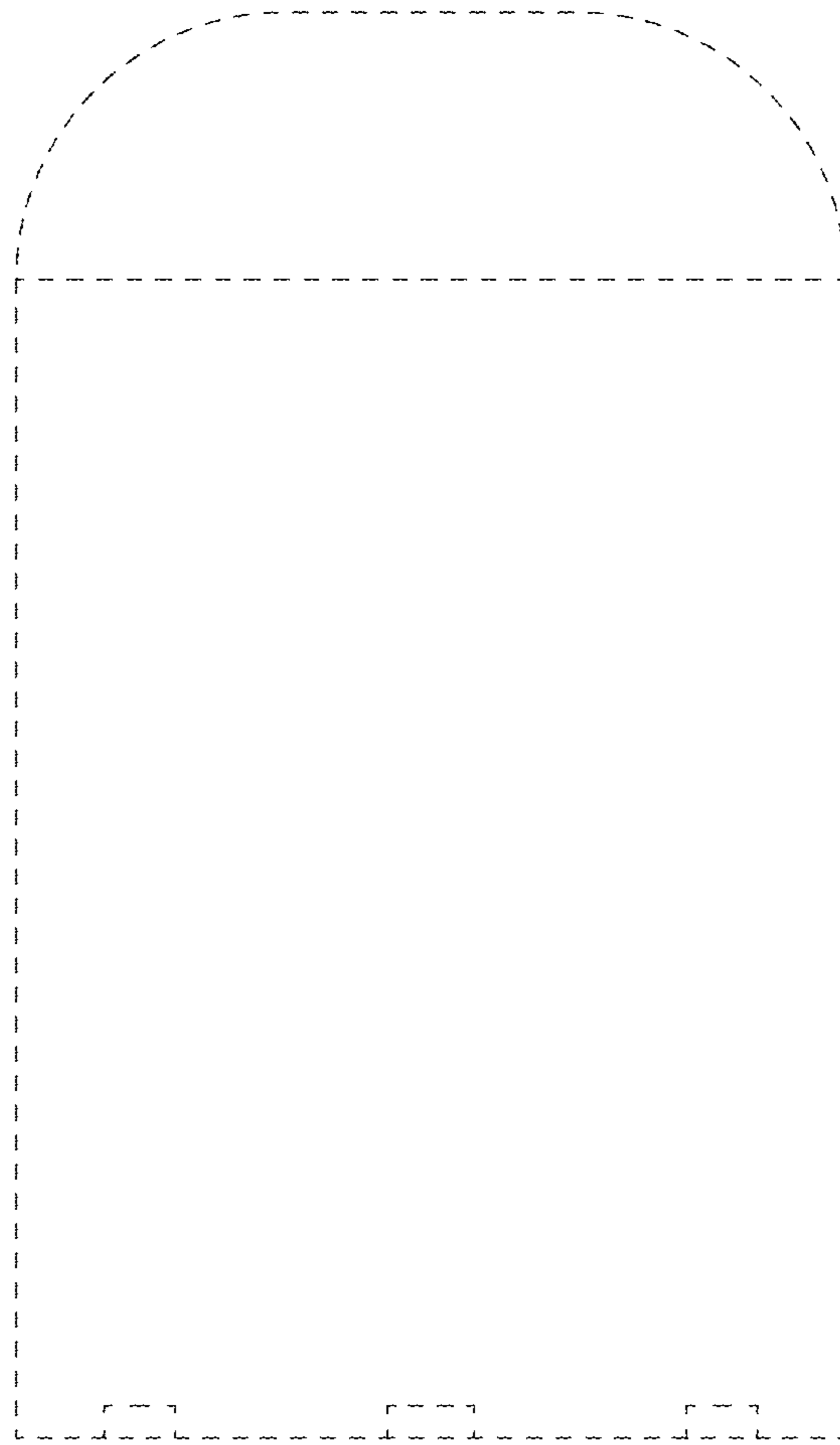

FIG. 10

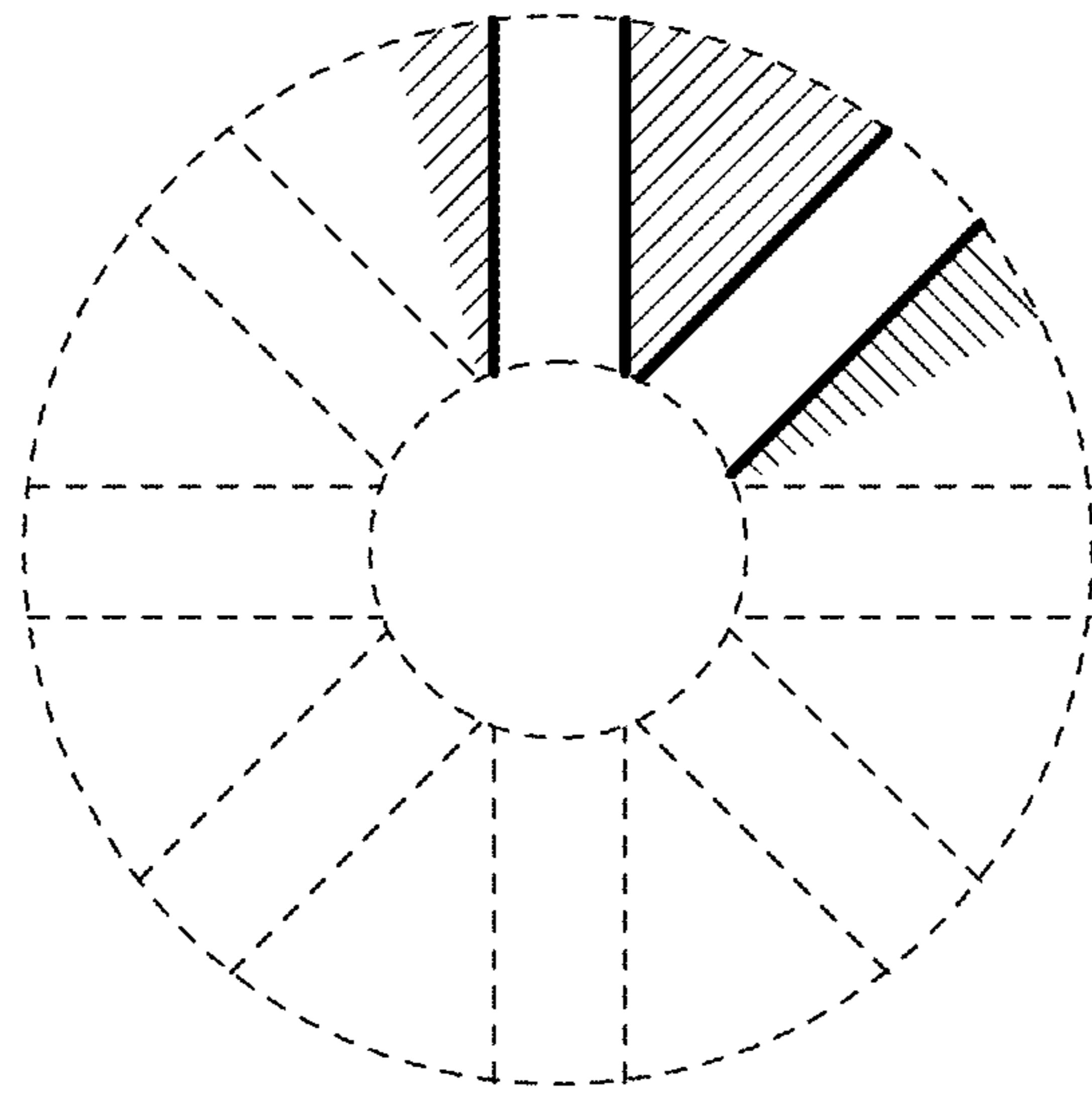

FIG. 11

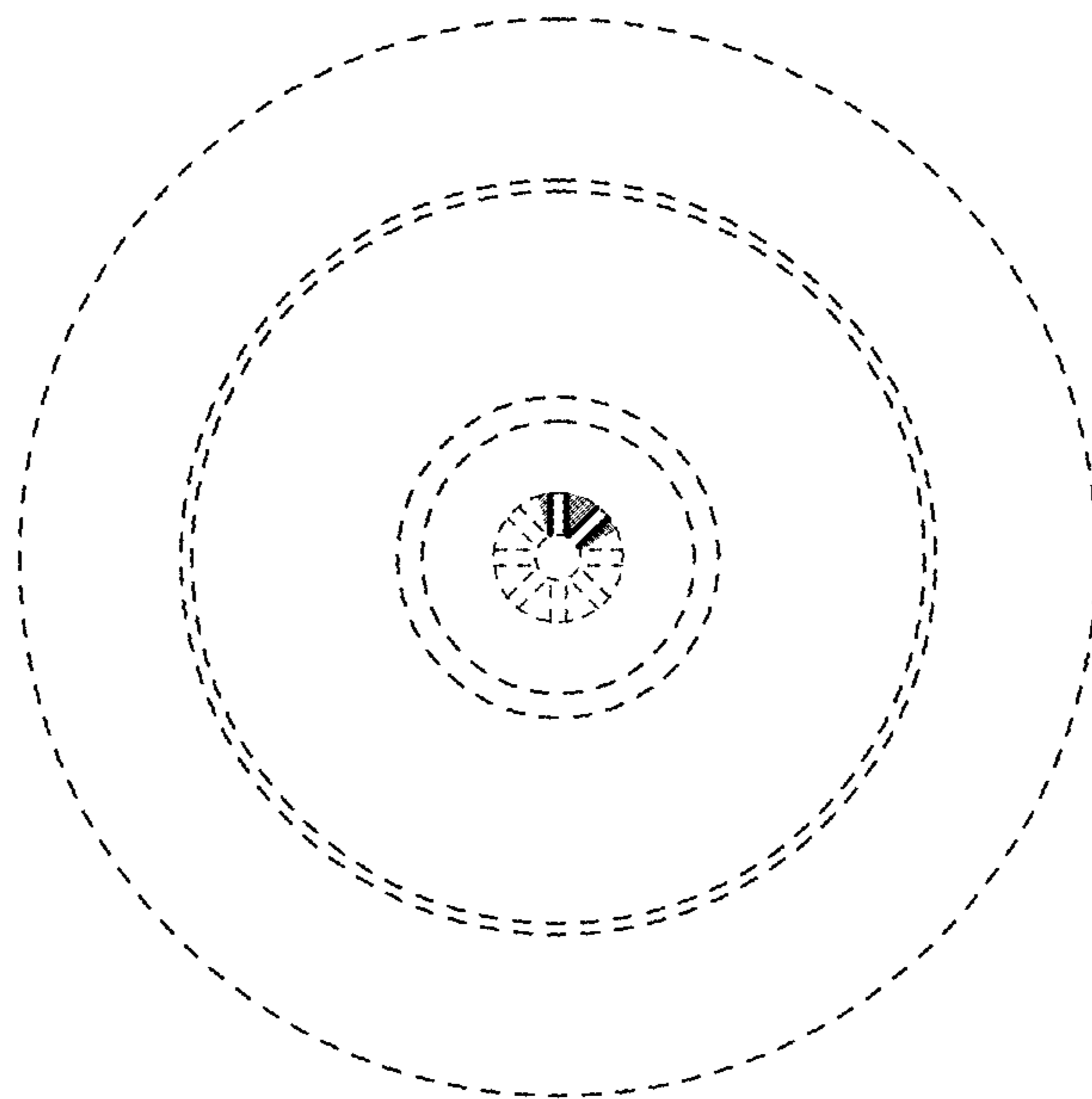

FIG. 12

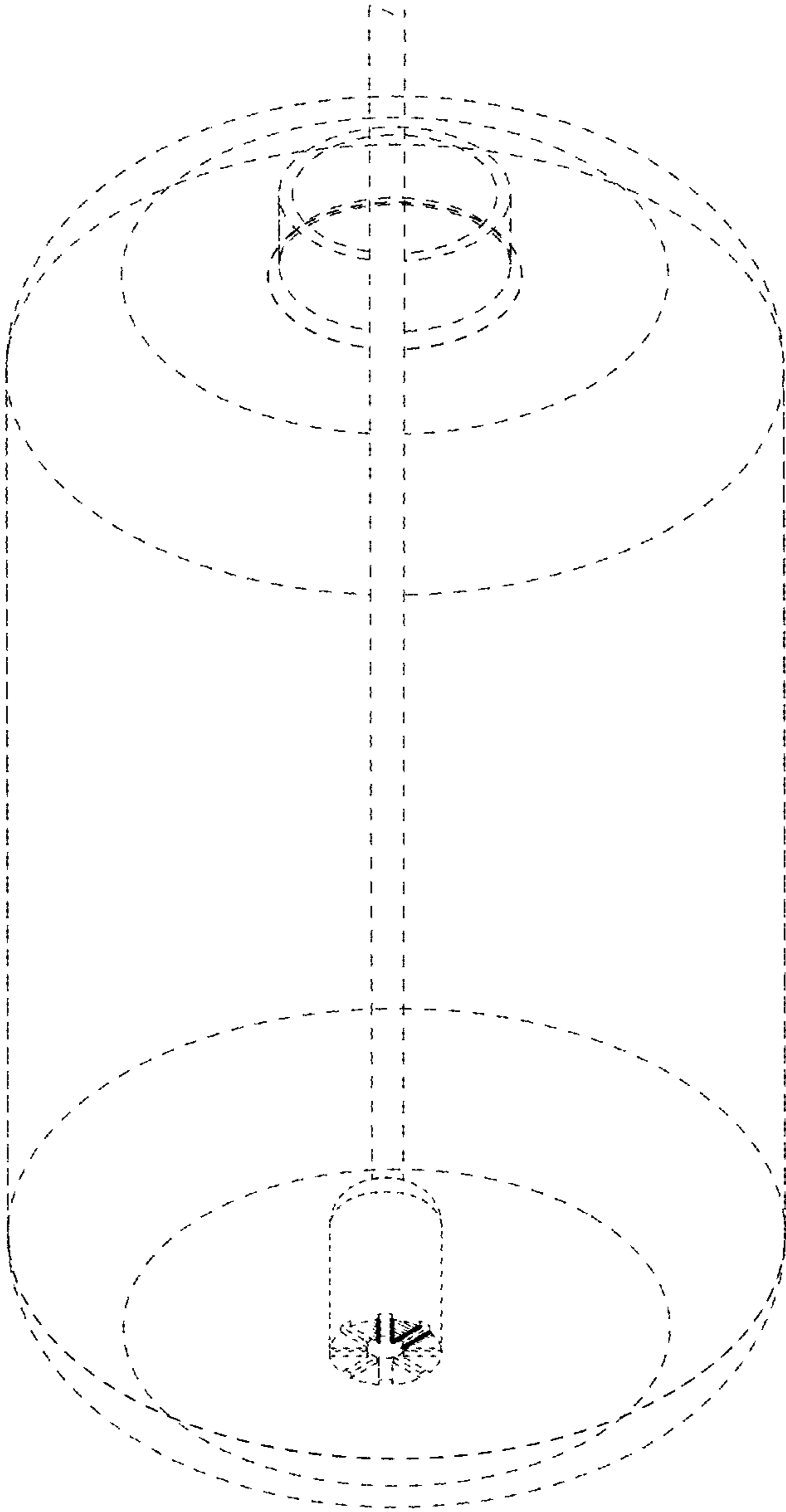

FIG. 13

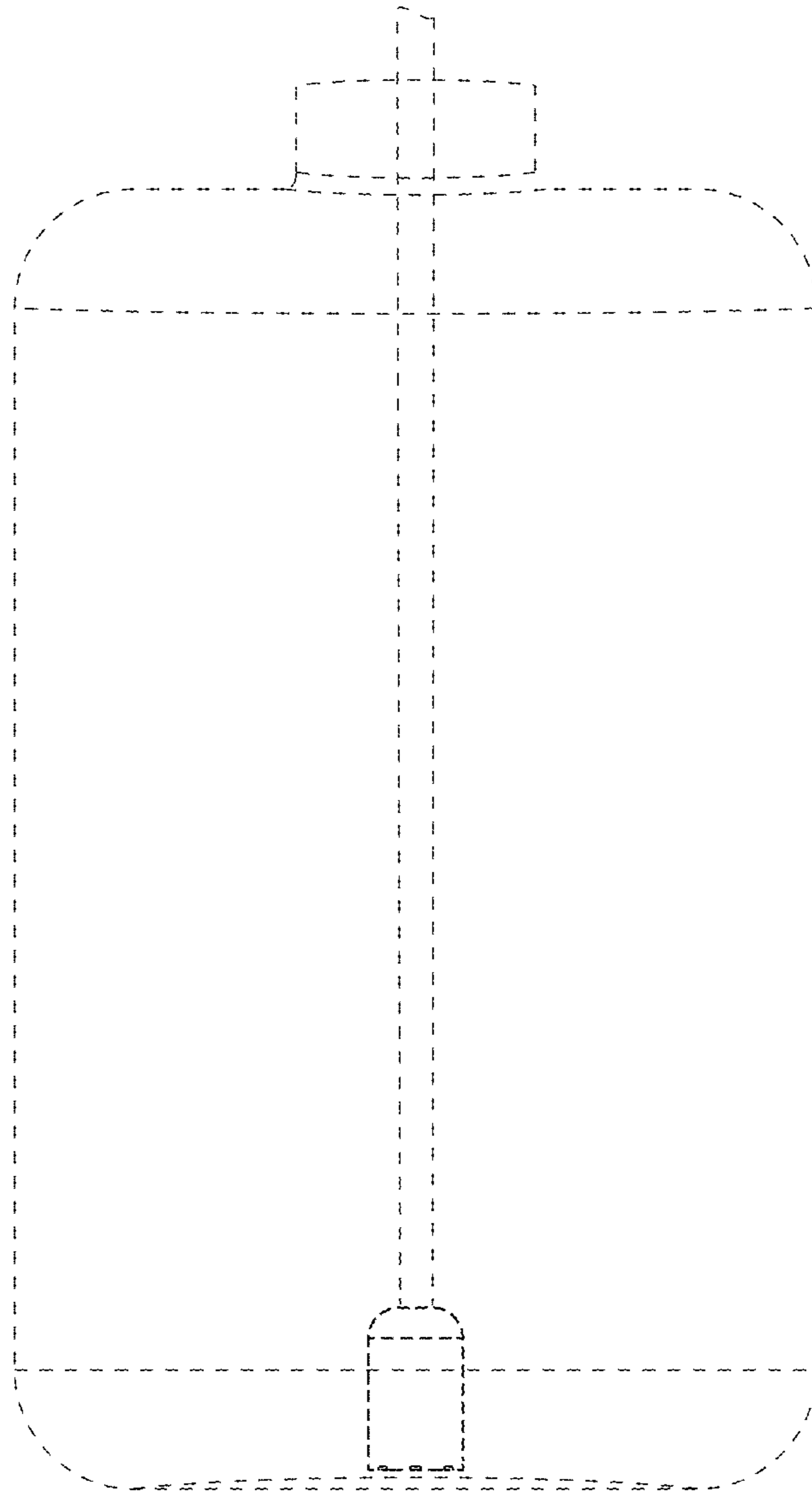

FIG. 14

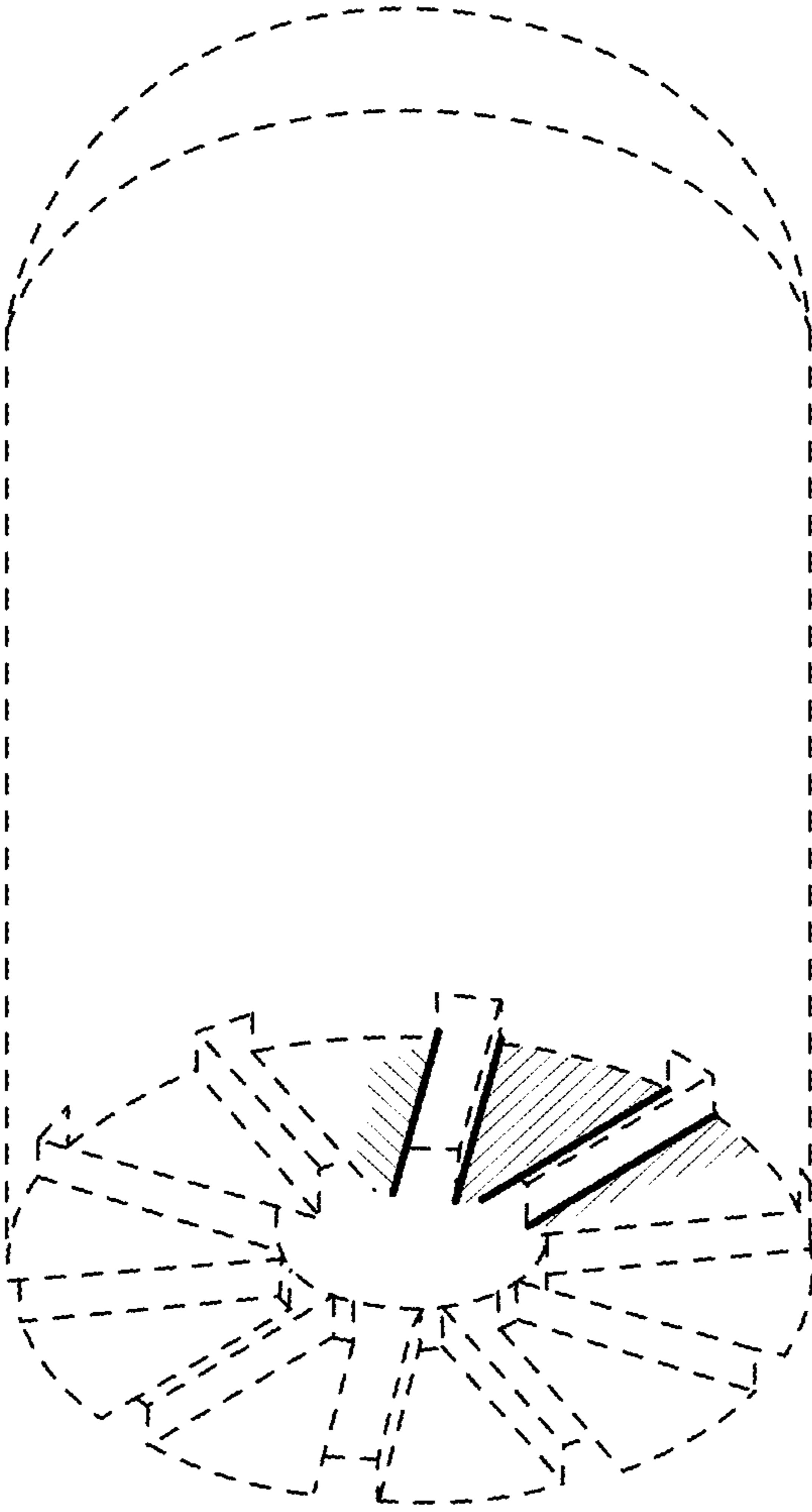

FIG. 15

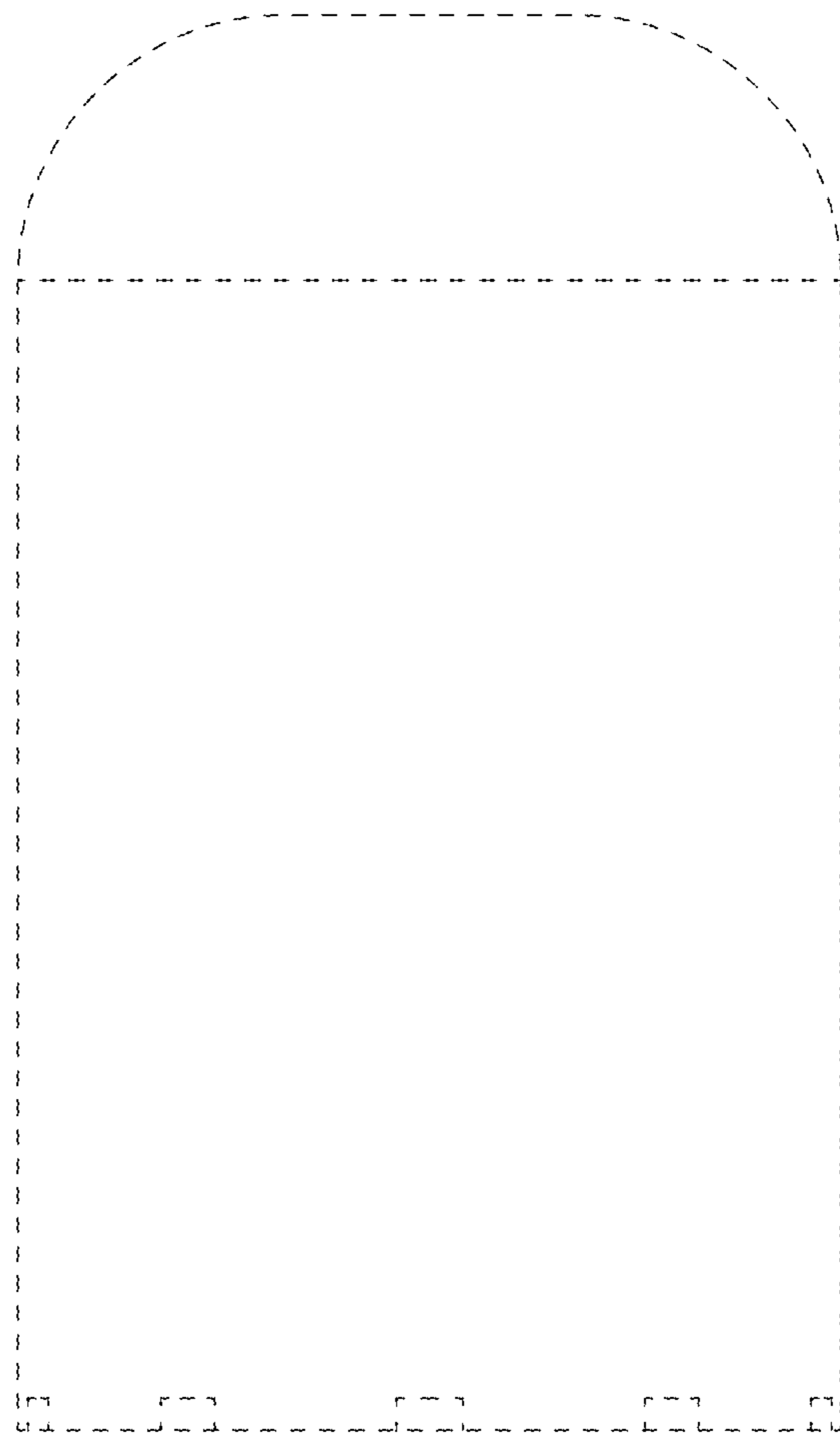

FIG. 16

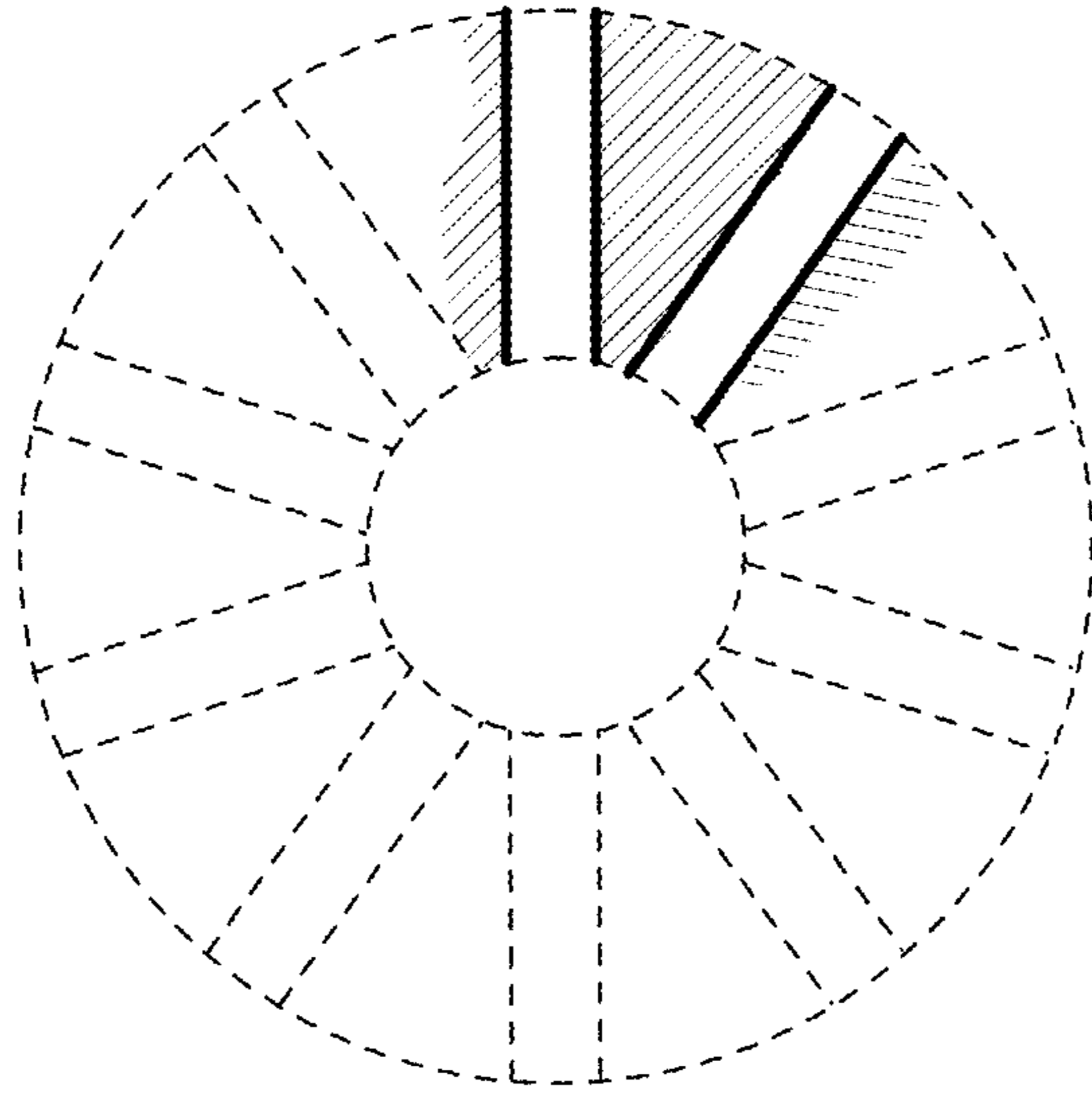

FIG. 17

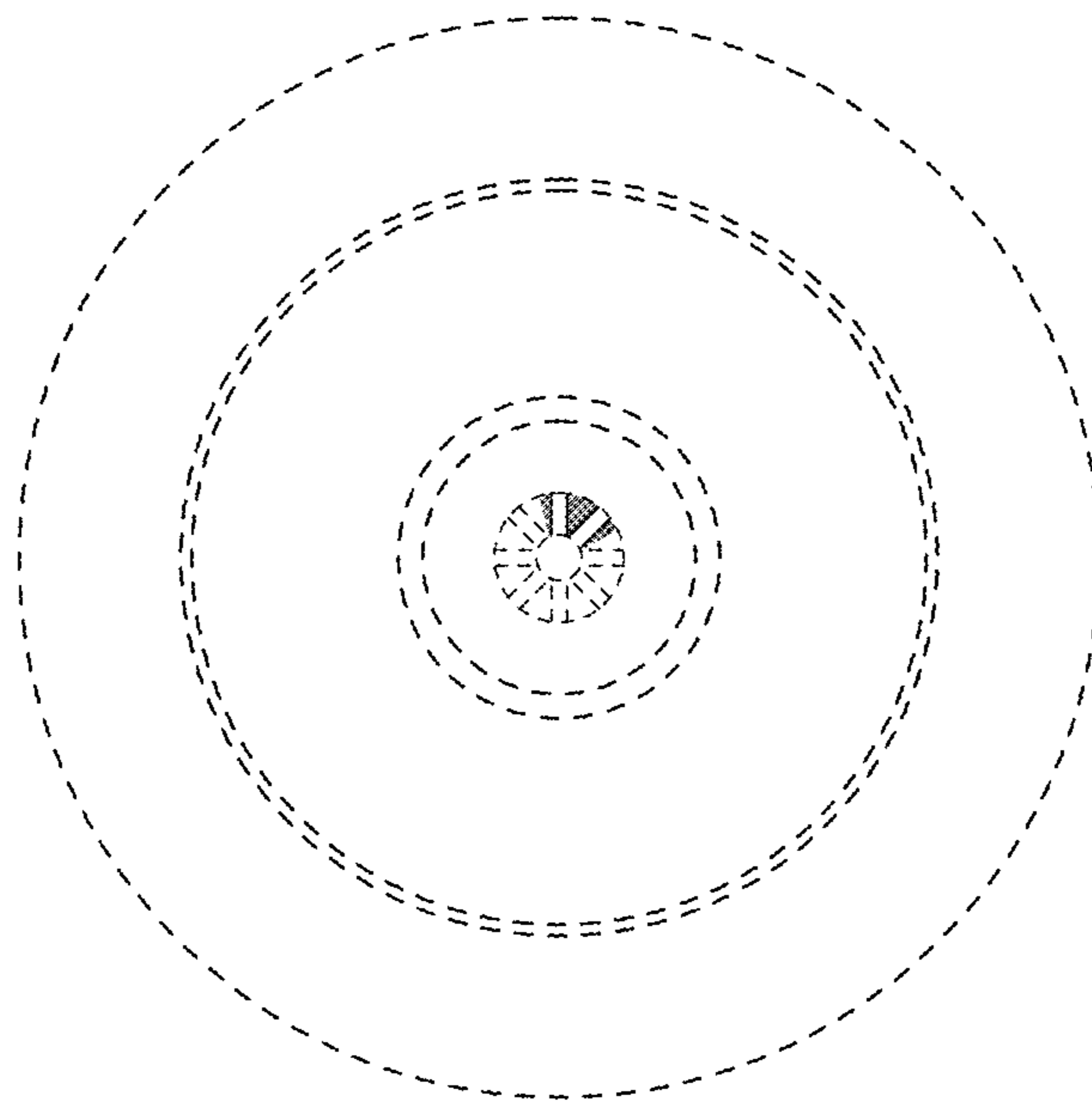

FIG. 18



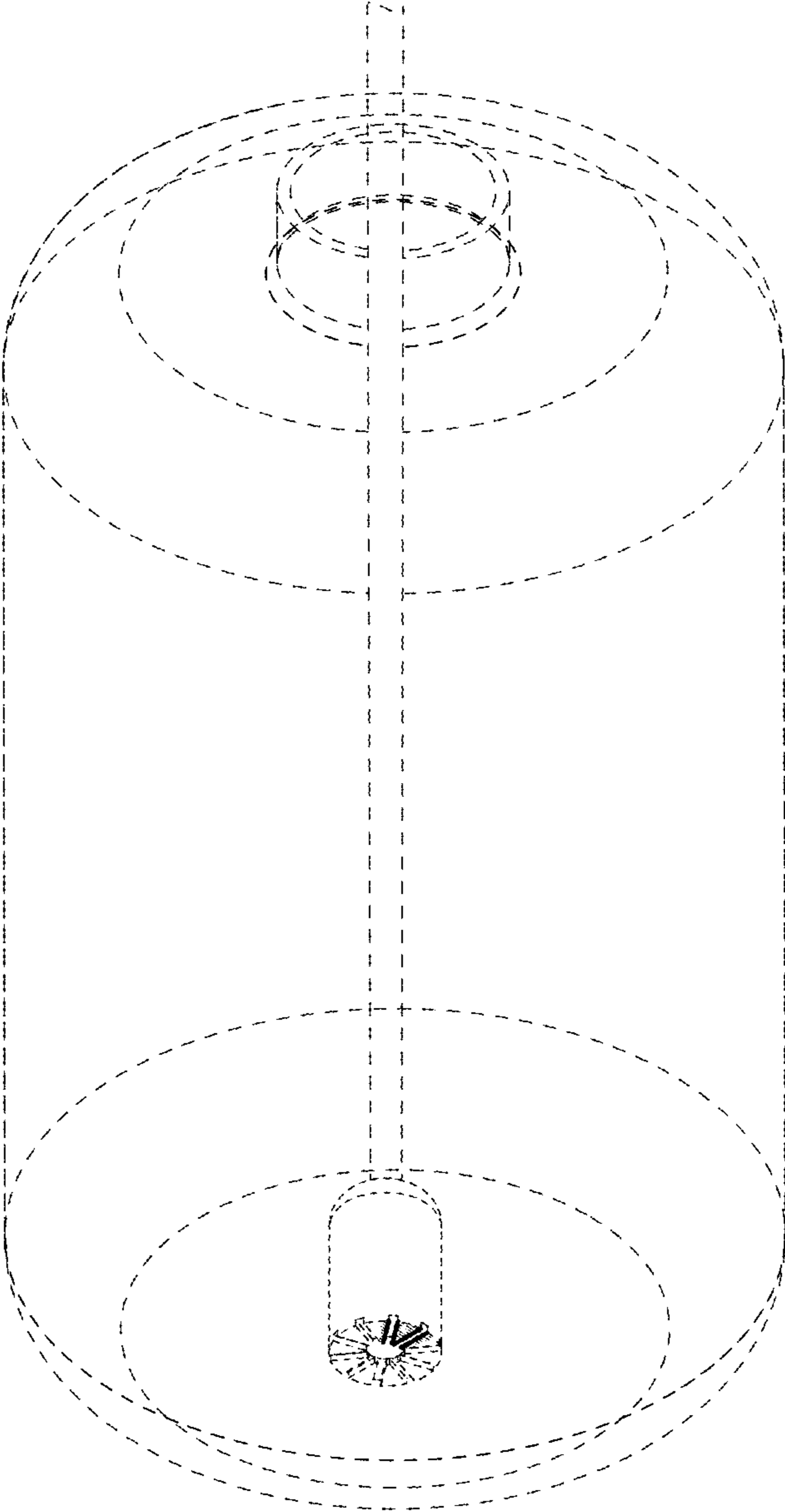
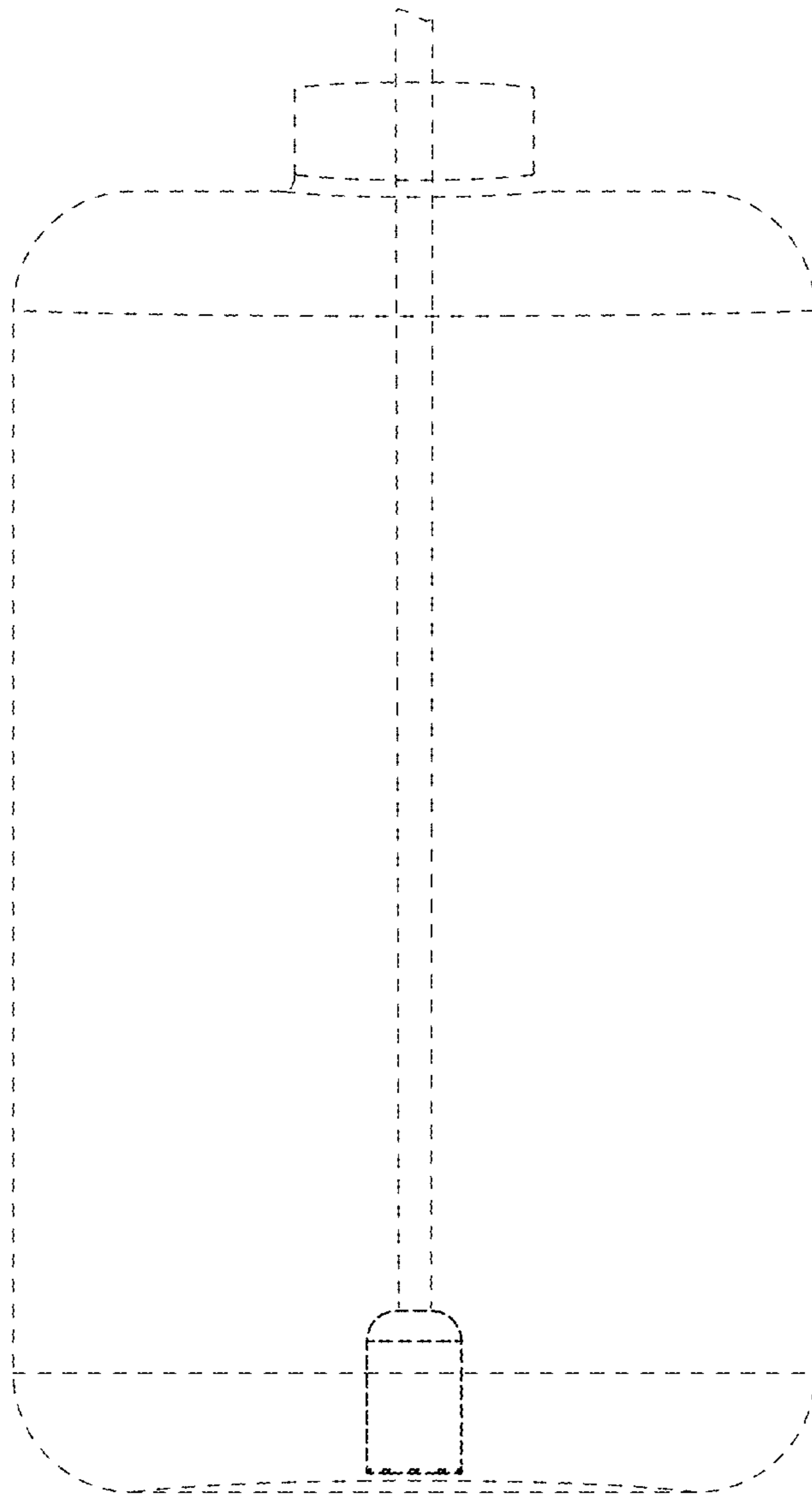

FIG. 19



**FIG. 20**