



US00D791315S

(12) **United States Design Patent**  
**Hartley**

(10) **Patent No.:** **US D791,315 S**  
(45) **Date of Patent:** **\*\* Jul. 4, 2017**

(54) **NASAL DILATOR DEVICE**  
(71) Applicant: **ASAP BreatheAssist Pty Ltd,**  
Armadale (AU)

6,270,512 B1 8/2001 Rittmann  
6,562,057 B2 5/2003 Santin  
7,055,523 B1 6/2006 Brown  
(Continued)

(72) Inventor: **Toby James Hartley,** Armadale (AU)  
(73) Assignee: **ASAP BreatheAssist Pty Ltd,**  
Armadale (AU)

**FOREIGN PATENT DOCUMENTS**

EP 2387978 A2 11/2011  
JP H11192251 A 7/1999  
(Continued)

(\*\*) Term: **15 Years**

**OTHER PUBLICATIONS**

(21) Appl. No.: **29/569,108**

Turbine—How to Use, announced Mar. 4, 2015 [online], [site visited Nov. 7, 2016]. Available from internet, URL: <<https://www.youtube.com/watch?v=kRLYL306Ly0>>.\*

(22) Filed: **Jun. 23, 2016**

(Continued)

(30) **Foreign Application Priority Data**

Dec. 24, 2015 (AU) ..... 201517103

(51) **LOC (10) Cl.** ..... **24-02**

(52) **U.S. Cl.**  
USPC ..... **D24/135**

(58) **Field of Classification Search**  
USPC ..... D24/135, 110.5, 231, 110.1, 106;  
128/848

CPC .. A61F 5/08; A61F 5/56; A61B 1/233; A61M  
29/02; A61M 29/00

See application file for complete search history.

*Primary Examiner* — Keli L Hill

*Assistant Examiner* — Karra S Johnson

(74) *Attorney, Agent, or Firm* — Withrow & Terranova,  
PLLC

(57) **CLAIM**

The ornamental design for a nasal dilator device, as shown and described.

**DESCRIPTION**

FIG. 1 is a front perspective view of a nasal dilator device showing my design;  
FIG. 2 is a rear perspective view of the nasal dilator device;  
FIG. 3 is a front elevation view of the nasal dilator device;  
FIG. 4 is a rear elevation view of the nasal dilator device;  
FIG. 5 is a right side elevation view of the nasal dilator device;  
FIG. 6 is a left side elevation view of the nasal dilator device;  
FIG. 7 is a bottom plan view of the nasal dilator device; and,  
FIG. 8 is a top plan view of the nasal dilator device.

(56) **References Cited**

**U.S. PATENT DOCUMENTS**

3,451,392 A \* 6/1969 Cook ..... A62B 23/06  
128/206.11

4,576,168 A 3/1986 Jalowayski  
4,759,365 A 7/1988 Askinazy  
5,099,857 A 3/1992 Baldo et al.  
5,787,884 A 8/1998 Tovey  
5,895,409 A 4/1999 Mehdizadeh  
5,955,376 A 9/1999 Tovey  
6,109,262 A 8/2000 Tovey

**1 Claim, 8 Drawing Sheets**

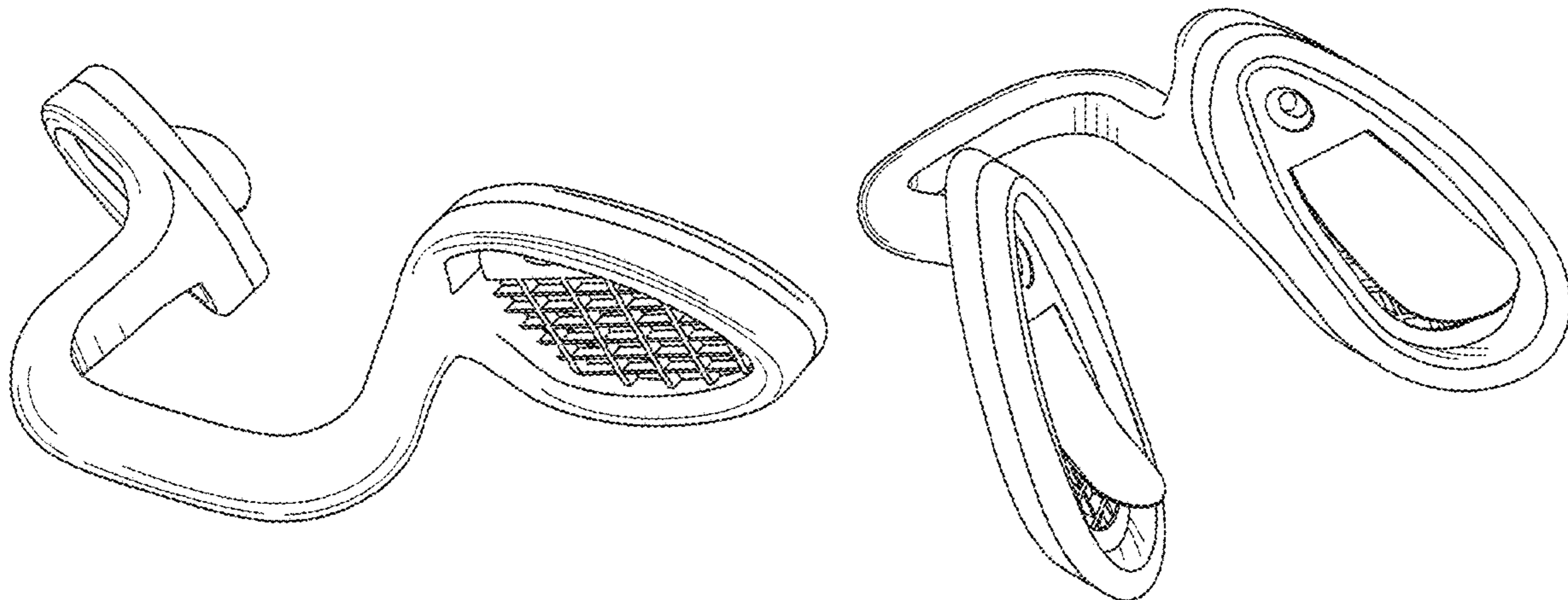

(56)

References Cited

U.S. PATENT DOCUMENTS

7,105,008	B2	9/2006	Maryanka	
7,318,438	B2	1/2008	Brown	
D571,457	S *	6/2008	Dolezal .....	D24/106
7,390,331	B2	6/2008	Santin et al.	
7,461,651	B2	12/2008	Brown	
7,727,252	B2	6/2010	Maryanka	
7,740,643	B2	6/2010	Maryanka	
D635,240	S *	3/2011	Tohara .....	D24/106
8,048,102	B2	11/2011	Thomas	
D652,143	S	1/2012	Brown	
8,262,688	B2	9/2012	Santin et al.	
D670,382	S *	11/2012	Noce .....	D24/135
8,403,954	B2	3/2013	Santin et al.	
8,491,622	B2	7/2013	Brown	
D754,850	S *	4/2016	Pepper .....	D24/135
D754,851	S *	4/2016	Pepper .....	D24/135
D759,239	S *	6/2016	Hartley .....	D24/135
2003/0106555	A1	6/2003	Tovey	
2003/0144684	A1	7/2003	Ogle	
2004/0261798	A1 *	12/2004	Rimkus .....	A62B 23/06 128/206.11
2005/0021073	A1	1/2005	Santin et al.	
2010/0063532	A1	3/2010	Moore	
2010/0087749	A1	4/2010	Tovey	
2011/0118775	A1	5/2011	Brown	
2013/0296809	A1	11/2013	Santin et al.	
2016/0235577	A1 *	8/2016	Lei .....	A61M 15/085
2016/0256716	A1 *	9/2016	Lei .....	A62B 23/06

FOREIGN PATENT DOCUMENTS

KR	100893945	B1	4/2009
WO	9936773	A1	7/1999
WO	0078223	A1	12/2000
WO	0162342	A1	8/2001
WO	0231465	A1	4/2002
WO	02059569	A1	8/2002
WO	2007119041	A1	10/2007
WO	2009124567	A1	10/2009
WO	2011104660	A2	9/2011

OTHER PUBLICATIONS

4 Myths You Need to Know about Nasal Dilator, announced Sep. 9, 2014 [online], [site visited Nov. 7, 2016]. Available from internet, URL: <<https://www.bestsellers.co/4-myths-need-know-nasal-dilator/>>.\*

Anti Snore Solution with Filter, announced Nov. 3, 2015 [online], [site visited Nov. 7, 2016]. Available from internet, URL: <<https://www.amazon.com/Solution-Dilator-Nasdil-Snoring-antiallergic/dp/B0165MVAGE>>.\*

WoodyKnows Super Defense Nose, announced Jun. 29, 2013 [online], [site visited Nov. 7, 2016]. Available from internet, URL: <[https://www.amazon.com/WoodyKnows-Allergens-Pollution-Particles-Replacement/dp/B00SHELUP0/ref=pd\\_sim\\_121\\_5?ie=UTF8&refRID=FRWJYQZR10PZJS39P1SY&th=1](https://www.amazon.com/WoodyKnows-Allergens-Pollution-Particles-Replacement/dp/B00SHELUP0/ref=pd_sim_121_5?ie=UTF8&refRID=FRWJYQZR10PZJS39P1SY&th=1)>.\*

Author Unknown, "AirWare Laboratories," web.archive.org/web/20120522113321/http://www.airwarelab.com/, dated May 22, 2012, retrieved Jun. 17, 2016, AirWare Labs, 7 pages.

Author Unknown, "Breathe-Aide," Visionworx, inc, web.archive.org/web/20141108204923/http://breatheaide.fm.alibaba.com/, dated Nov. 8, 2014, retrieved Jun. 20, 2016, Alibaba.com, 1 page.

Author Unknown, "Breathe EZ Anti-Snoring Medical Nasal Device-Snoring Cure," web.archive.org/web/20120618221246/http://www.snoringcure.ca/breathe\_ez\_nasal\_anti\_snoring\_medical\_device.htm, dated Jun. 18, 2012, retrieved Jun. 17, 2016, SnoringCure.ca, pp. 1-2.

Author Unknown, "Breathe Ezy Nasal Filters®," web.archive.org/web/20120615192635/http://www.breathe-ezy.com.au/, dated Jun. 15, 2012, retrieved Jun. 17, 2016, Breathe ezy Nasal Filters®, 2 pages.

Author Unknown, "Breathing Relief™," web.archive.org/web/20120413210250/http://www.breathingrelief.com/, dated Apr. 13, 2012, retrieved Jun. 20, 2016, Breathing Relief, pp. 1-2.

Author Unknown, "ClipAir® Anti-Snoring Nasal Dilator Device/Contre le Rontlement," web.archive.org/web/20120618061055/http://www.snoringcure.ca/clipair\_nasal\_anti\_snoring\_medical\_dilator\_device.htm, dated Jun. 18, 2012, retrieved Jun. 17, 2016, SnoringCure.ca, pp. 1-2.

Author Unknown, "Flents Breathe Quiet! Nasal Dilator—Stop Snoring!," web.archive.org/web/20120425220535/http://www.amazon.com/Flents-Breathe-Quiet-Nasal-Dilator/dp/B0019IHLR2, dated Apr. 25, 2012, retrieved Jun. 17, 2016, Amazon.com, Inc., pp. 1-4.

Author Unknown, "Flents Breathe Well Nasal Dilator—The Alternative to Nasal Strips," web.archive.org/web/20120411195907/http://www.amazon.com/Flents-Breathe-Well-Nasal-Dilator/dp/B001J4K5E2, dated Apr. 11, 2012, retrieved Jun. 17, 2016, Amazon.com, Inc., pp. 1-4.

Author Unknown, "inhalClip," web.archive.org/web/20120413113017/http://www.oscimedsa.com/Stress\_insomnie\_stop, dated Apr. 13, 2012, retrieved Jun. 17, 2016, OSCIMED SA, pp. 1-3.

Author Unknown, "Max-Air Nose Cones," web.archive.org/web/20120725110753/http://www.maxairnosecones.com/max-air-nose-cones, dated Jul. 25, 2012, retrieved Jun. 17, 2016, Sanostec, Inc., pp. 1-5.

Author Unknown, "Reduznore Anti Snore Device," web.archive.org/web/20150411042458/https://www.wellnessproducts.ch/?lan=en&page=2&kat=246, dated Apr. 11, 2015, retrieved Jun. 20, 2016, Toernell & Bluecher GmbH, 1 page.

Author Unknown, "Nasal Pass Dilator," https://web.archive.org/web/20120630121946/http://nasalpass.com/contact\_us.htm, dated Jun. 30, 2012, retrieved Jun. 24, 2016, Med Tech Devices Inc., pp. 1-2.

Author Unknown, "Nasilator," www.nasilator.com/, 2014, retrieved Jun. 20, 2016, Nasal-Air Corp., pp. 1-2.

Author Unknown, "NoseGlobes," web.archive.org/web/20110128162352/http://noseglobes.com, dated Jan. 28, 2011, retrieved Jun. 20, 2016, NoseGlobes.com, 1 page.

Author Unknown, "Nozovent® Anti-Snoring Medical Nasal Dilator Device," web.archive.org/web/20120619012956/http://www.snoringcure.ca/nozovent\_nasal\_anti\_snoring\_medical\_dilator\_device.htm, dated Jun. 19, 2012, retrieved Jun. 17, 2016, SnoringCure.ca, pp. 1-3.

Author Unknown, "Original Breathe Fit Snoring Aid Nasal Dilator," web.archive.org/web/20120619035547/http://www.amazon.com/Original-Breathe-Fit-Nasal-Dilator/dp/B0012RMWC4, dated Jun. 19, 2012, retrieved Jun. 17, 2016, Amazon.com, Inc., pp. 1-5.

Author Unknown, "Sanispirao," web.archive.org/web/20120712044423/http://www.sanispira.it/eng/index.php, lated Jul. 12, 2012, retrieved Jun. 20, 2016, HSD Europe, pp. 1-3.

Author Unknown, "Sinus Cones—Breathe Well, Sleep Well," web.archive.org/web/20120206054639/http://www.sanostec.com/code/productinfo.htm, dated Feb. 6, 2012, retrieved Jun. 17, 2016, Sanostec, 2 pages.

Author Unknown, "SleepRight," www.sleepright.com/nasal-breathe-aid/, retrieved Jun. 20, 2016, Splintek, Inc., pp. 1-6.

Author Unknown, "Snoreben© ," www.benmedical.com.au/snoreben, 2014, retrieved Jun. 20, 2016, Benson Medical Services Pty Ltd, pp. 1-2.

Author Unknown, "Snore Free," web.archive.org/web/20120614222005/http://www.magnetictherapy.co.uk/scp/SPECIALITY\_PRODUCTS/SNORE\_FREE.html, dated Jun. 14, 2012, retrieved Jun. 17, 2016, Magnetic Therapy LTD, 2 pages.

Author Unknown, "Snoregem," web.archive.org/web/20120627060249/http://www.britishsnoring.co.uk/shop/snoregem.php, dated Jun. 27, 2012, retrieved Jun. 20, 2016, British Snoring and Sleep Apnoea Association, 1 page.

Author Unknown, "Snore-no-More," web.archive.org/web/20120626140524/http://www.britishsnoring.co.uk/shop/nasal\_dilators/snore\_no\_more.php, dated Jun. 26, 2012, retrieved Jun. 17, 2016, British Snoring & Sleep Apnoea Association, 1 page.

(56)

**References Cited**

OTHER PUBLICATIONS

Author Unknown, "Ultimate Nasal Dilator© ," web.archive.org/web/20120718070024/http://www.nasalaid.com/, dated Jul. 18, 2012, retrieved Jun. 17, 2016, NasalAid, LLC, 1 page.

Author Unknown, "Snore Pin," web.archive.org/web/20130111010828/http://omnisleep.in/snore-pin.html, dated Jan. 11, 2013, retrieved Jun. 29, 2016, Omnisleep Solutions, pp. 1-2.

Author Unknown, "Super Nasal Filter for Allergy Relief," web.archive.org/web/20120818163139/http://www.woodyknows.com/, dated Aug. 18, 2012, retrieved Jun. 29, 2016, 35.com, pp. 1-3.

U.S. Appl. No. 10/842,220, filed May 10, 2004.

U.S. Appl. No. 13/848,374, filed Mar. 21, 2013.

U.S. Appl. No. 29/547,579, filed Dec. 4, 2015.

Quayle Action for U.S. Appl. No. 29/547,579, mailed Nov. 30, 2016, 8 pages.

\* cited by examiner

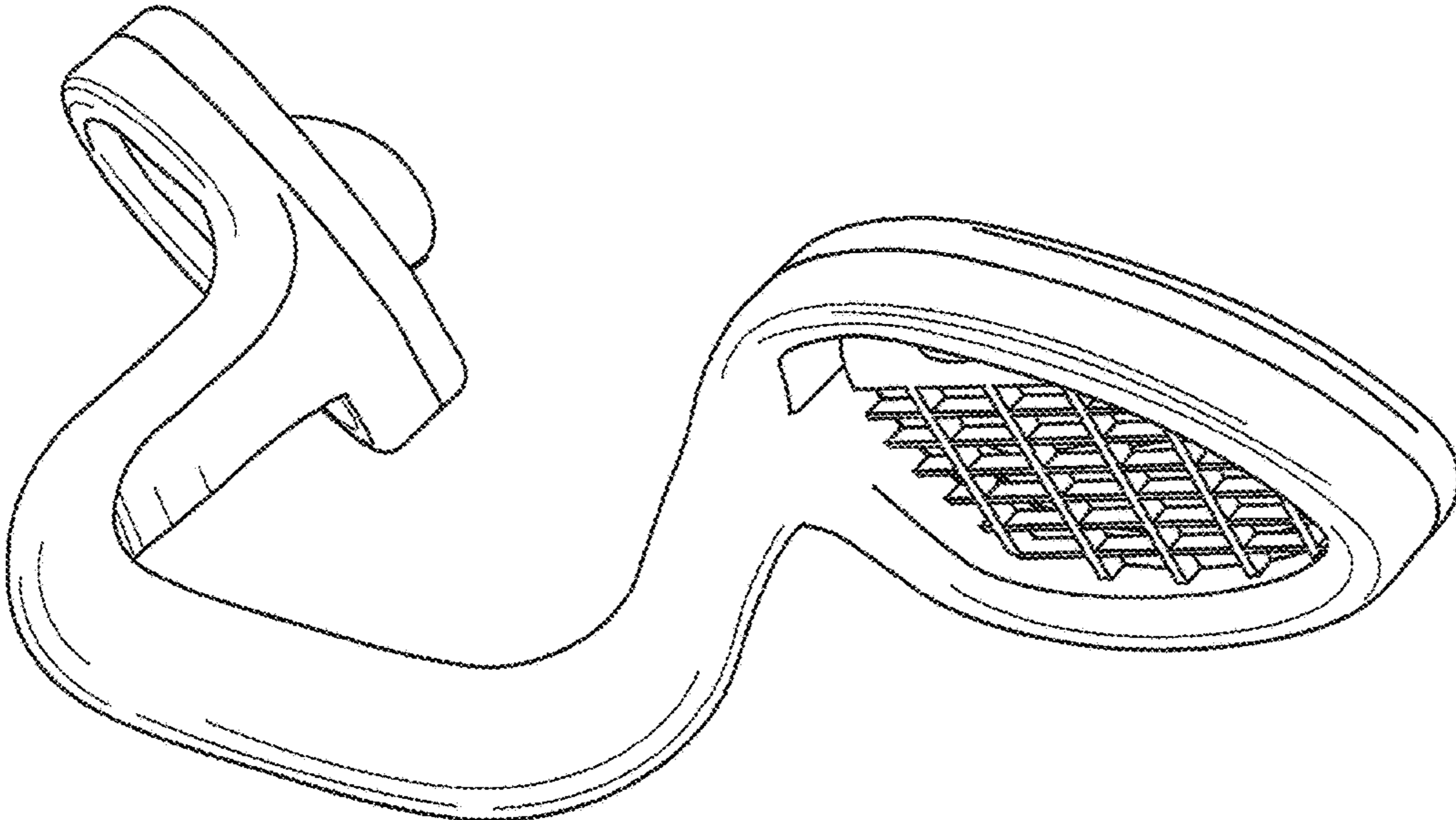

FIG. 1

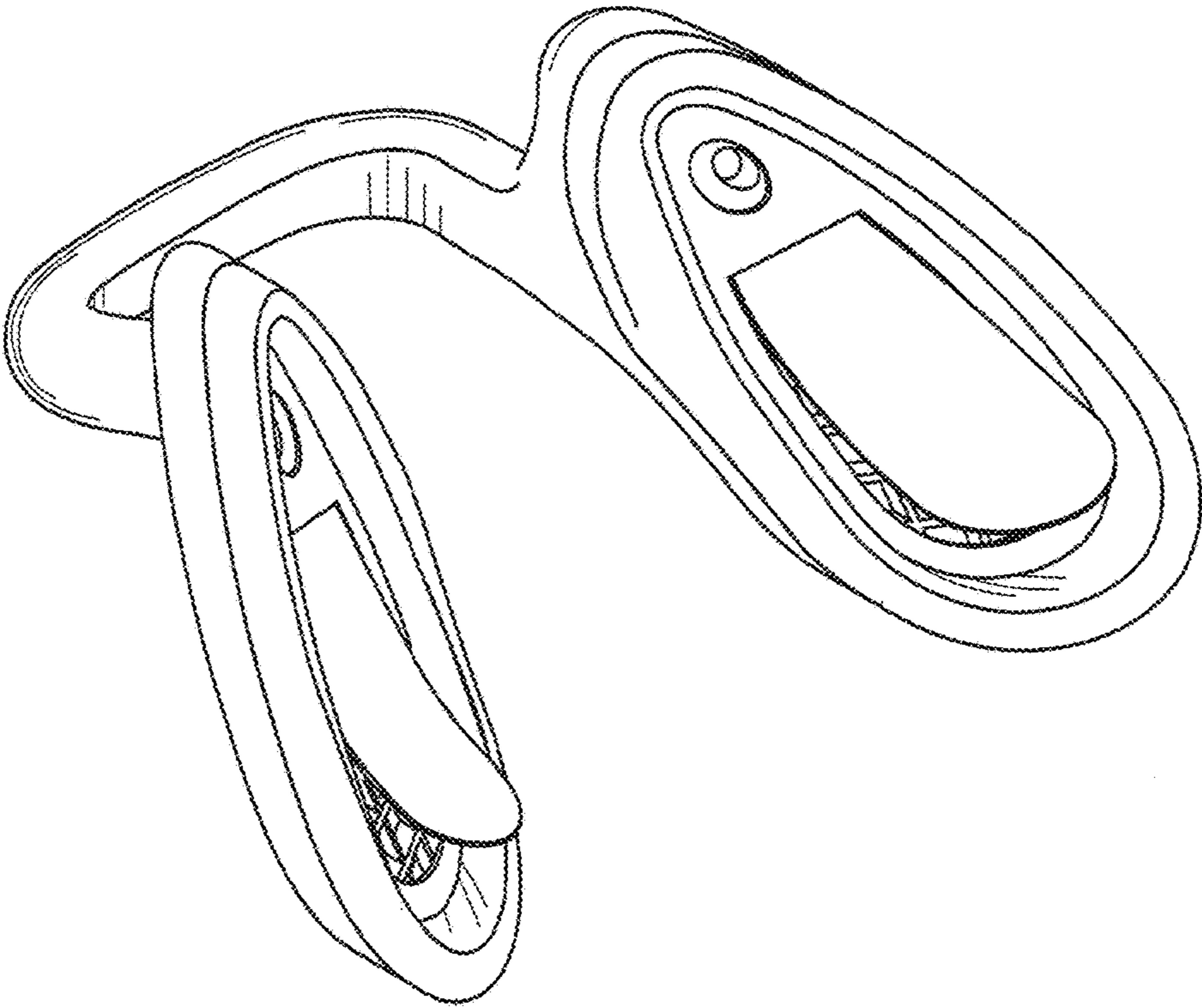
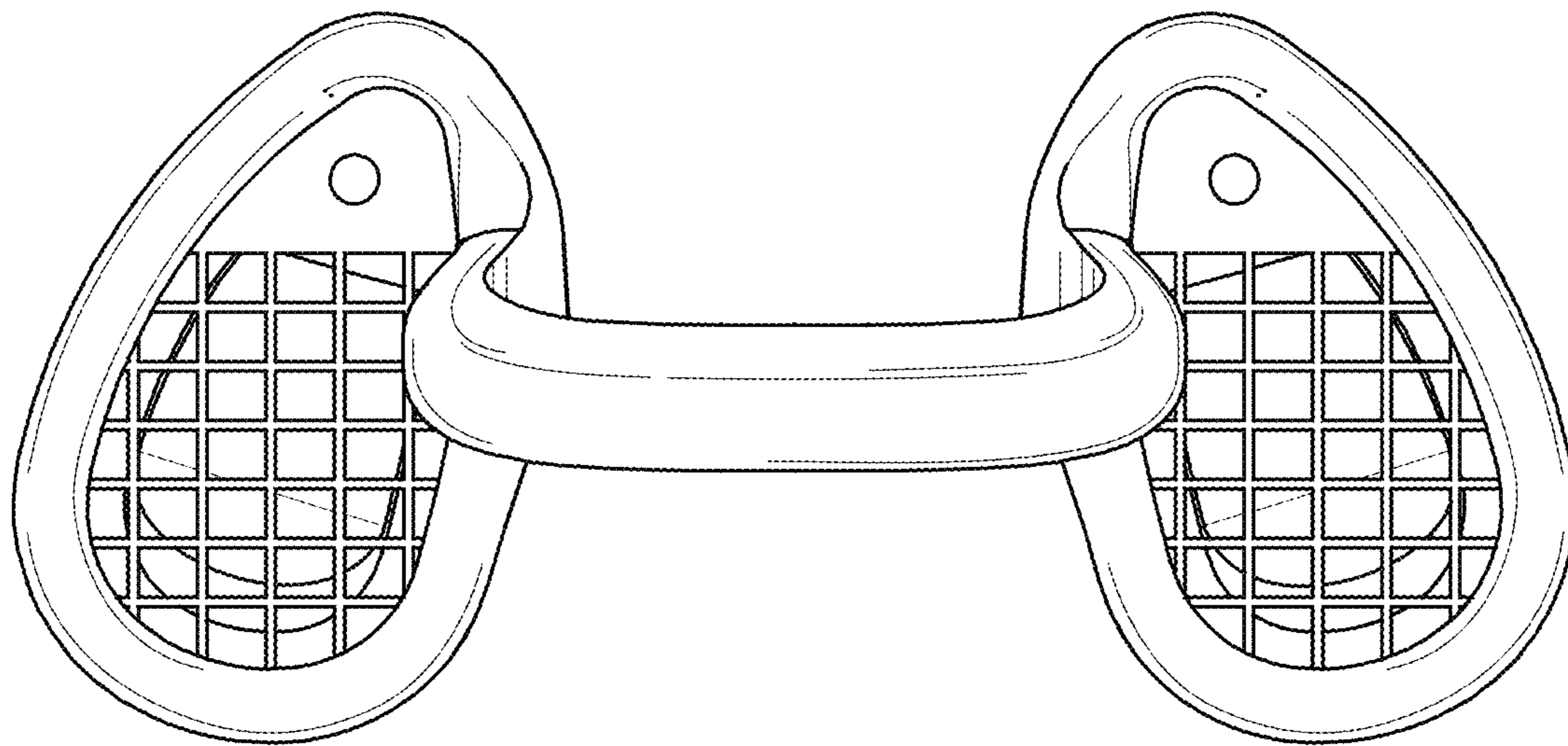
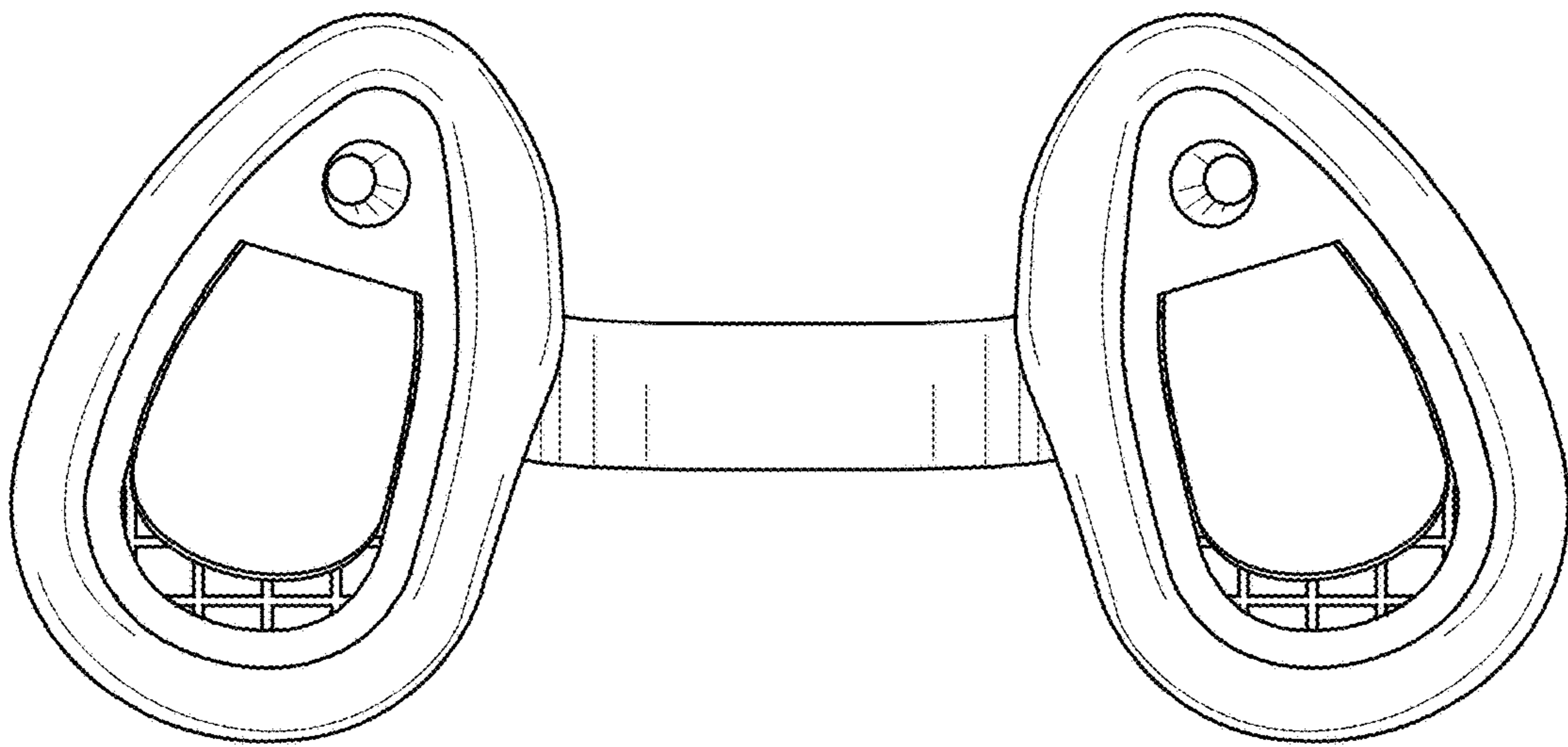

FIG. 2



**FIG. 3**



**FIG. 4**

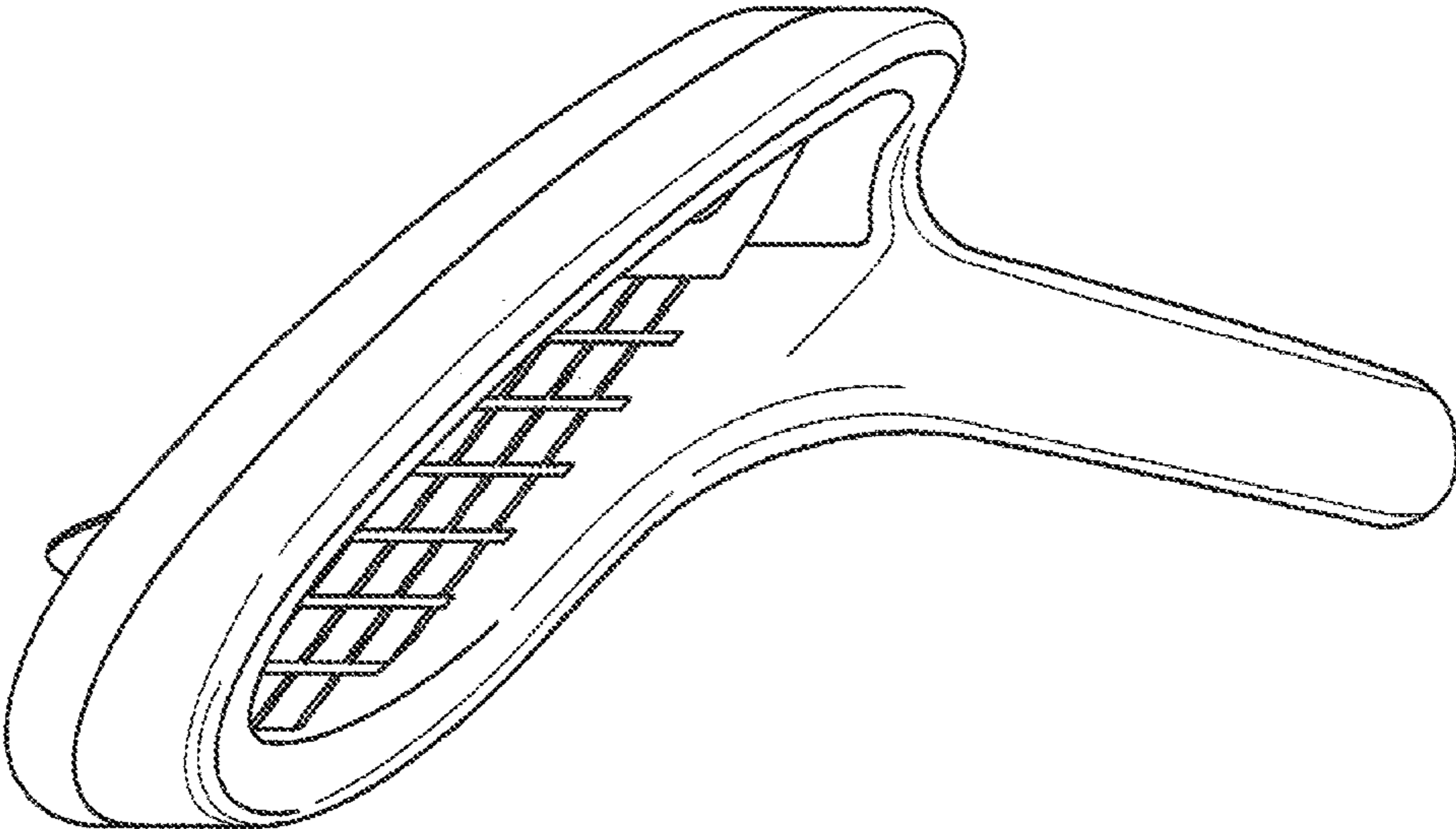

FIG. 5



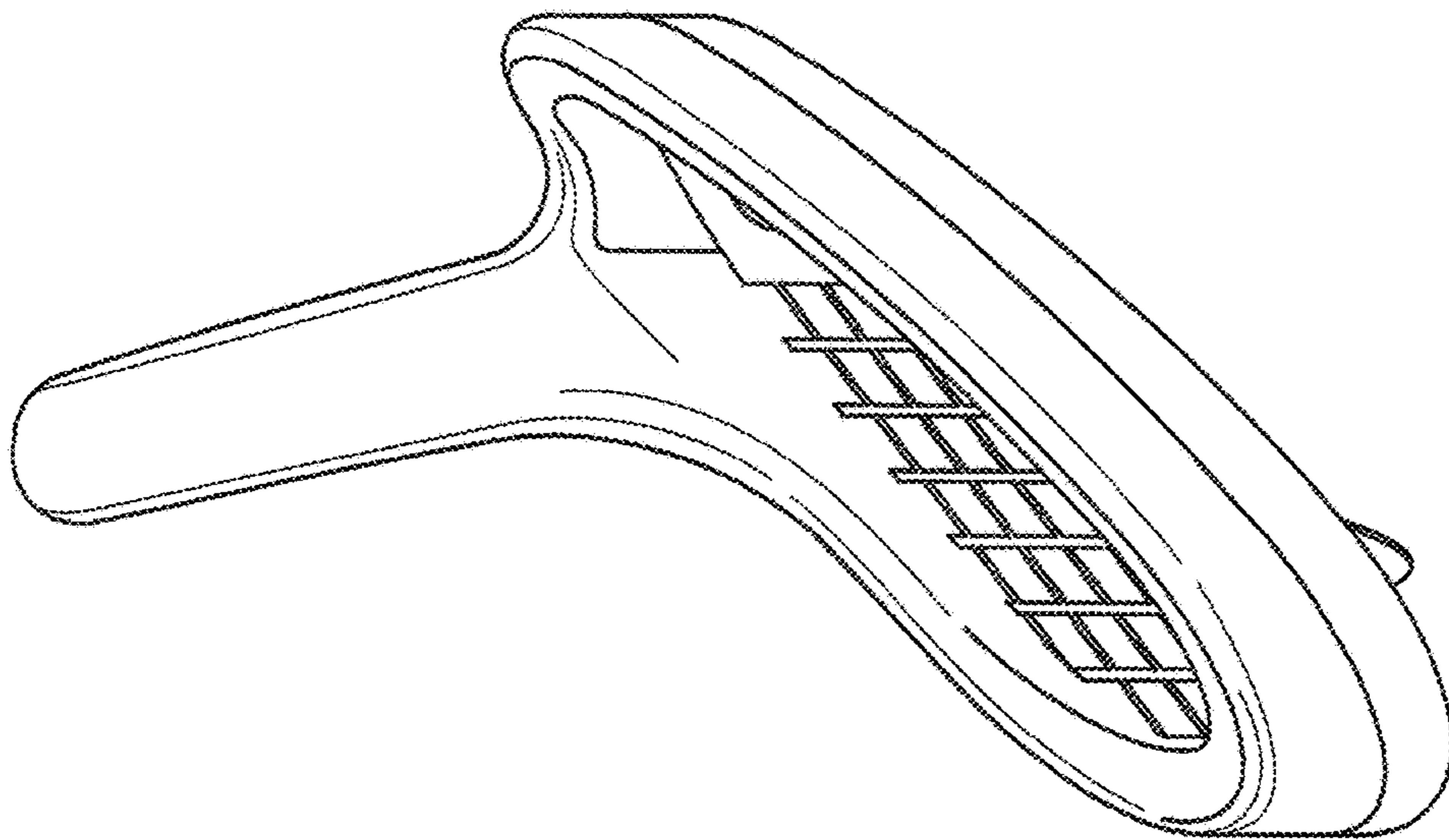

FIG. 6

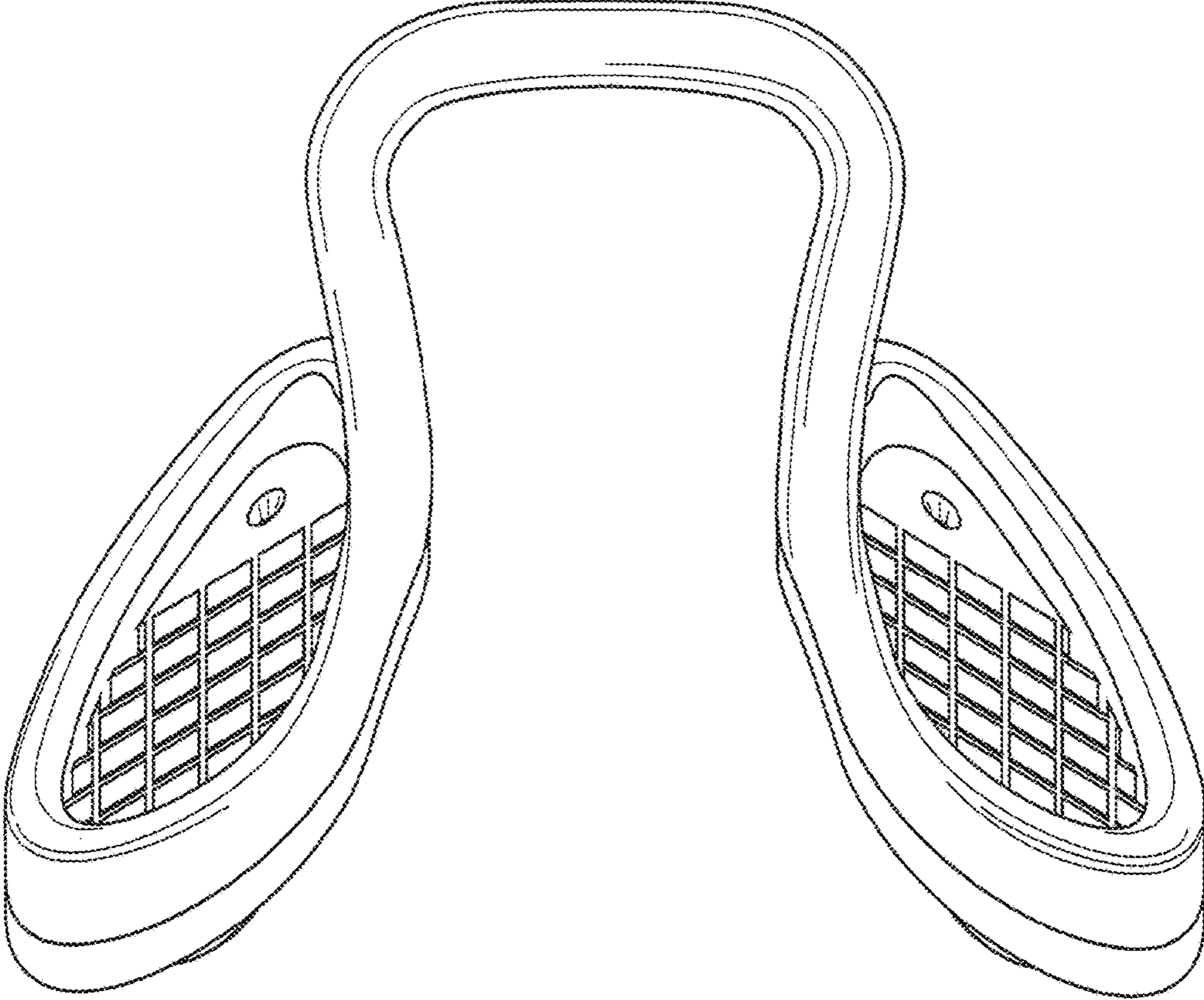

FIG. 7

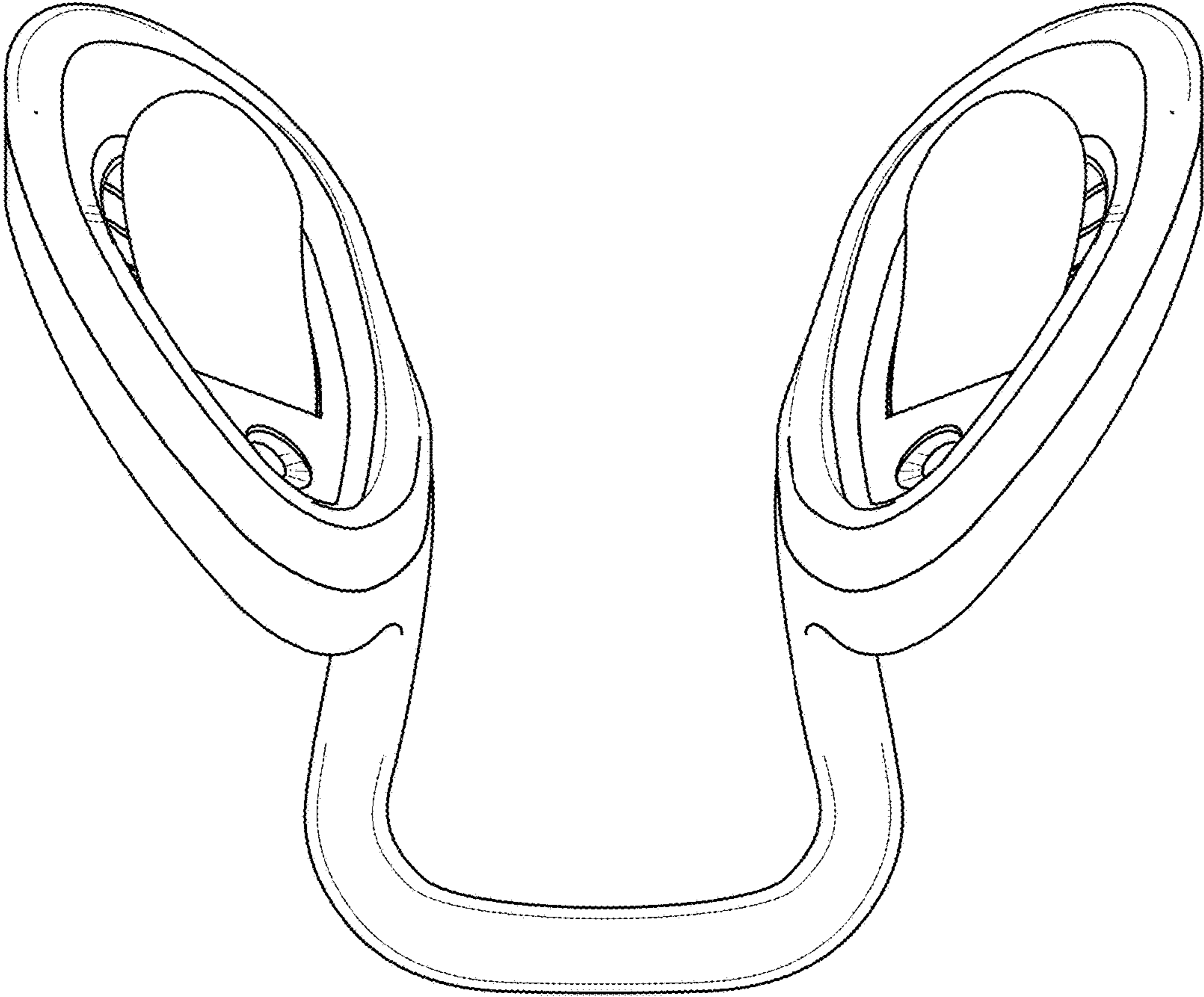

FIG. 8