



US00D791113S

(12) **United States Design Patent** (10) **Patent No.:** **US D791,113 S**
Tien et al. (45) **Date of Patent:** **** Jul. 4, 2017**

(54) **STAND COVER FOR ELECTRONIC COMMUNICATIONS DEVICE**

Primary Examiner — Carla Jobe Wright

(74) *Attorney, Agent, or Firm* — Birch, Stewart, Kolasch & Birch, LLP

(71) Applicant: **HTC Corporation**, Taoyuan (TW)

(72) Inventors: **Ernest Euan Tien**, Taoyuan (TW);
Chieh-Kai Wang, Taoyuan (TW);
Yien-Chun Kuo, Taoyuan (TW)

(57) **CLAIM**

The ornamental design for a stand cover for electronic communications device, as shown and described.

(73) Assignee: **HTC Corporation**, Taoyuan (TW)

(**) Term: **14 Years**

DESCRIPTION

(21) Appl. No.: **29/519,083**

(22) Filed: **Mar. 2, 2015**

(51) **LOC (10) Cl.** **14-03**

(52) **U.S. Cl.**
USPC **D14/250**

(58) **Field of Classification Search**
USPC D14/238.1, 440, 203.3–203.7, 217, 240,
D14/248, 251–253, 447, 496, 250;
(Continued)

FIG. 1 is a front perspective view of a first embodiment of a stand cover for electronic communications device in accordance with our new design;
 FIG. 2 is a front view thereof;
 FIG. 3 is a rear view thereof;
 FIG. 4 is a left side view thereof;
 FIG. 5 is a right side view thereof;
 FIG. 6 is a top plan view thereof;
 FIG. 7 is a bottom plan view thereof;
 FIG. 8 is a rear perspective view thereof;
 FIG. 9 is another front perspective view thereof shown in an alternate position as a stand for an electronic communications device;
 FIG. 10 is a front perspective view of a second embodiment of a stand cover for electronic communications device in accordance with our new design;
 FIG. 11 is a front view thereof;
 FIG. 12 is a rear view thereof;
 FIG. 13 is a left side view thereof;
 FIG. 14 is a right side view thereof;
 FIG. 15 is a top plan view thereof;
 FIG. 16 is a bottom plan view thereof;
 FIG. 17 is a rear perspective view thereof; and,
 FIG. 18 is another front perspective view thereof shown in an alternate position as a stand for an electronic communications device.

(56) **References Cited**

U.S. PATENT DOCUMENTS

1,613,536 A * 1/1927 Rose A45C 11/00
 132/315
 4,259,568 A * 3/1981 Dynesen G06F 15/0216
 206/305

(Continued)

FOREIGN PATENT DOCUMENTS

KR 30-0736821 S 4/2014
 KR 30-0754455 S 8/2014
 KR 30-0764284 S 10/2014

OTHER PUBLICATIONS

HTC Design Stand Case, URL:<<http://www.htc.com/us/accessories/htc-design-stand-case/#!pid=htc-one-m9>>, retrieved from internet on Nov. 17, 2016.*

(Continued)

(Continued)

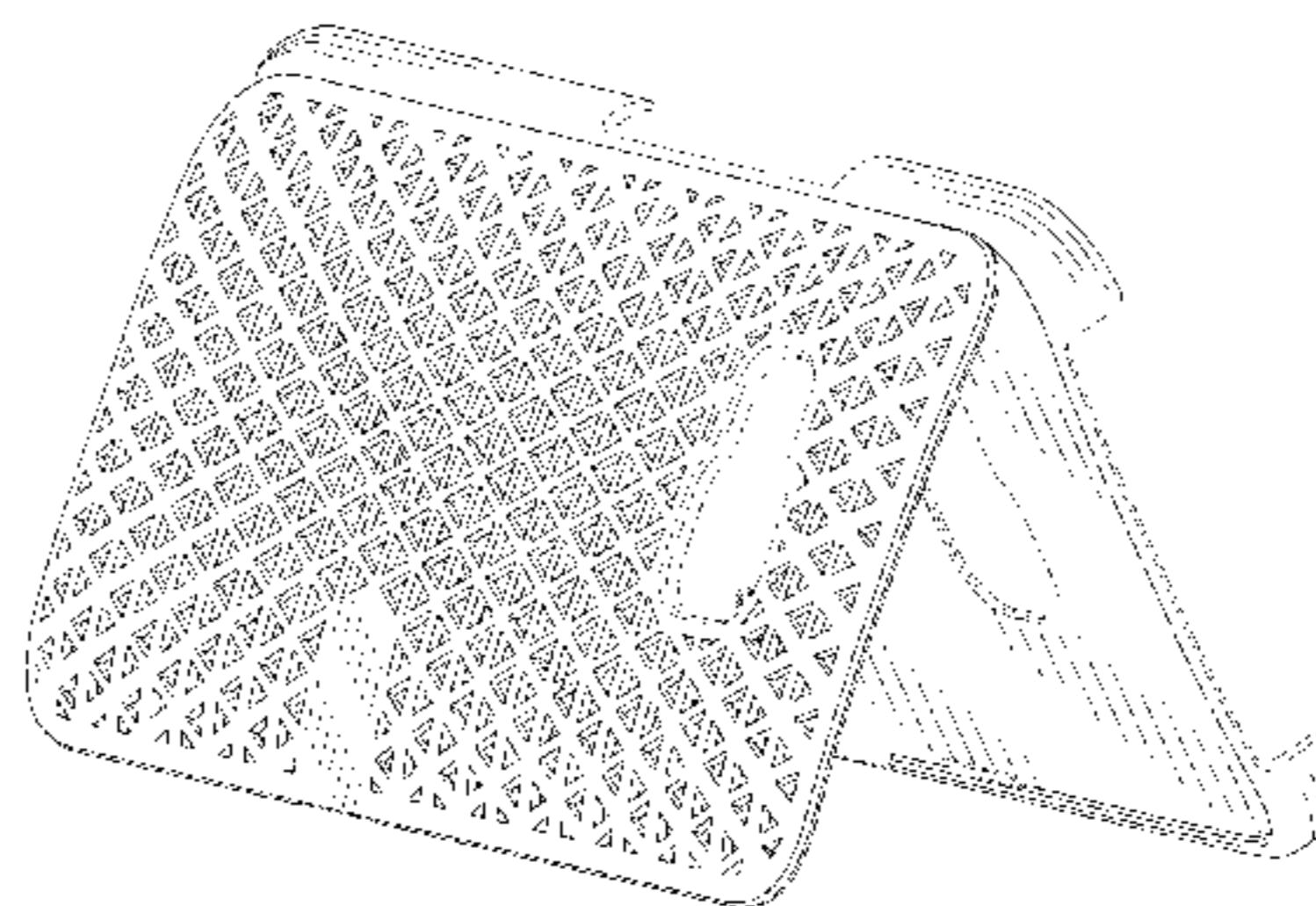
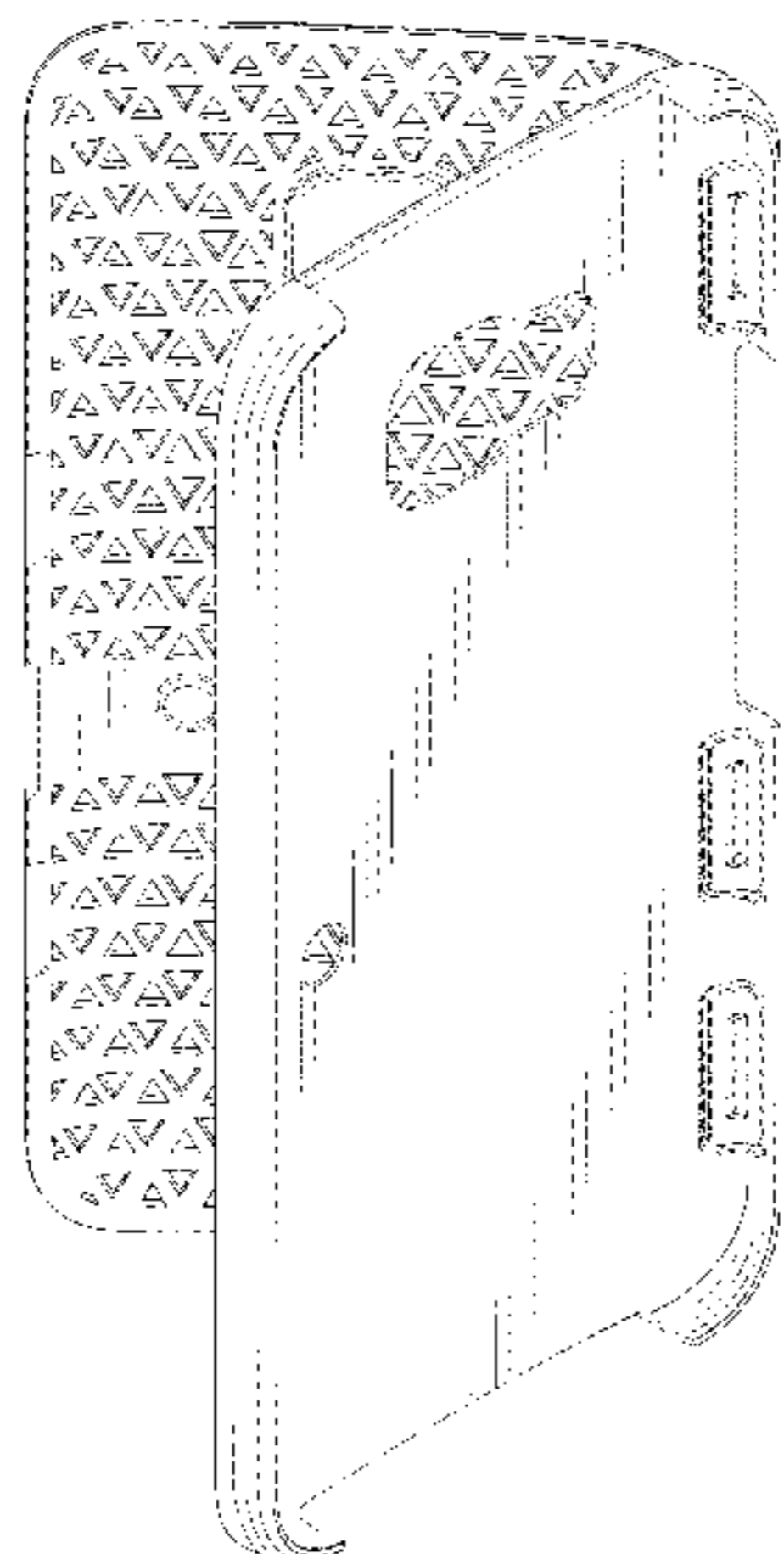

The broken lines and unshaded surfaces bounded by broken lines form no part of the embodiment of the claimed design in which they are shown.

1 Claim, 16 Drawing Sheets

(58) **Field of Classification Search**

USPC D3/201, 218, 247, 269, 273, 301, 303;
 D13/103, 107-108, 119
 CPC H04B 1/3888; H04M 1/0283; H04M 1/0202;
 A45C 1/06; A45C 2011/002; A45C 11/00;
 A45C 13/02; A45F 2005/026; A45F
 2200/0525; A45F 2200/0516
 See application file for complete search history.

(56) **References Cited**

U.S. PATENT DOCUMENTS

D559,230 S * 1/2008 Griffin D14/217
 D621,396 S * 8/2010 Lee D14/252
 D623,642 S * 9/2010 Wang D14/243
 D663,294 S * 7/2012 Buxton D14/250
 D679,271 S 4/2013 Liu
 D683,136 S * 5/2013 Wilson D3/218
 D685,785 S * 7/2013 Seoc D14/353
 8,522,965 B1 * 9/2013 Hsiung H04B 1/3888
 206/320
 D696,256 S * 12/2013 Piedra D14/440

D703,656 S * 4/2014 Witter D14/250
 D704,689 S * 5/2014 Chang D14/250
 D709,057 S * 7/2014 Wilson D14/250
 D712,391 S * 9/2014 Kim D14/250
 D719,945 S * 12/2014 Chiang D14/250
 D719,951 S * 12/2014 Fenton D14/253
 D721,359 S * 1/2015 Kim D14/250
 D754,115 S * 4/2016 Lin D14/250
 2012/0025039 A1 2/2012 Segal
 2012/0178507 A1* 7/2012 Lee A45C 11/00
 455/575.1
 2014/0049476 A1* 2/2014 Bragin G06F 1/169
 345/173
 2014/0051488 A1 2/2014 Chung
 2014/0262854 A1* 9/2014 Chen A45C 11/00
 206/45.24
 2014/0299488 A1* 10/2014 Andrew A45C 13/002
 206/37
 2014/0364176 A1* 12/2014 Pintor H04B 1/385
 455/575.6
 2016/0094263 A1* 3/2016 Fathollahi H04B 1/3888
 455/575.8

OTHER PUBLICATIONS

Internet Archive WayBack Machine date check of HTC Design Stand reference cited above, URL:<https://web.archive.org/web/*/http://www.htc.com/us/accessories/htc-design-stand-case/#!pid=htc-one-m9>, retrieved from internet on Nov. 17, 2016.*

* cited by examiner

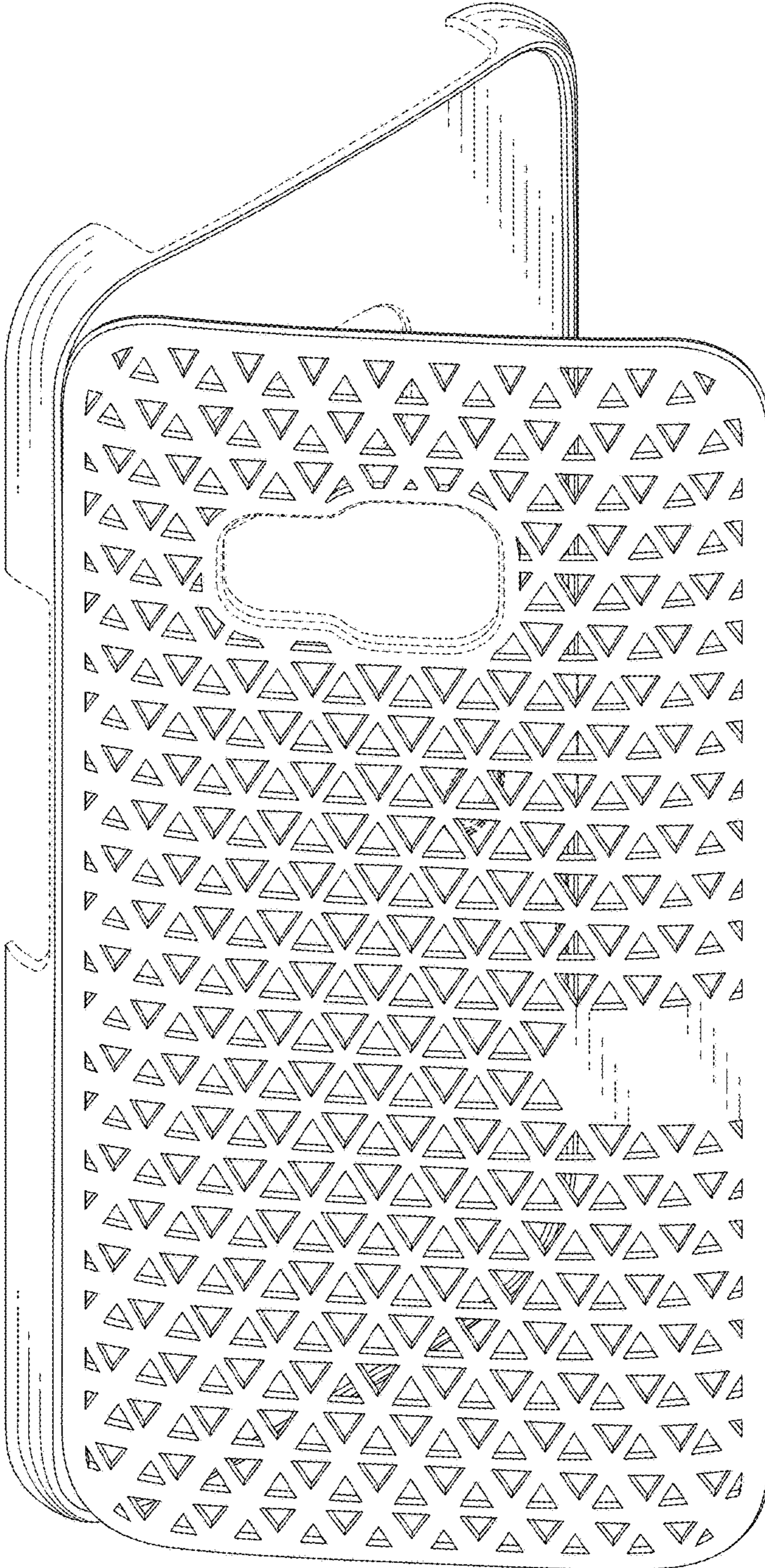

FIG. 1

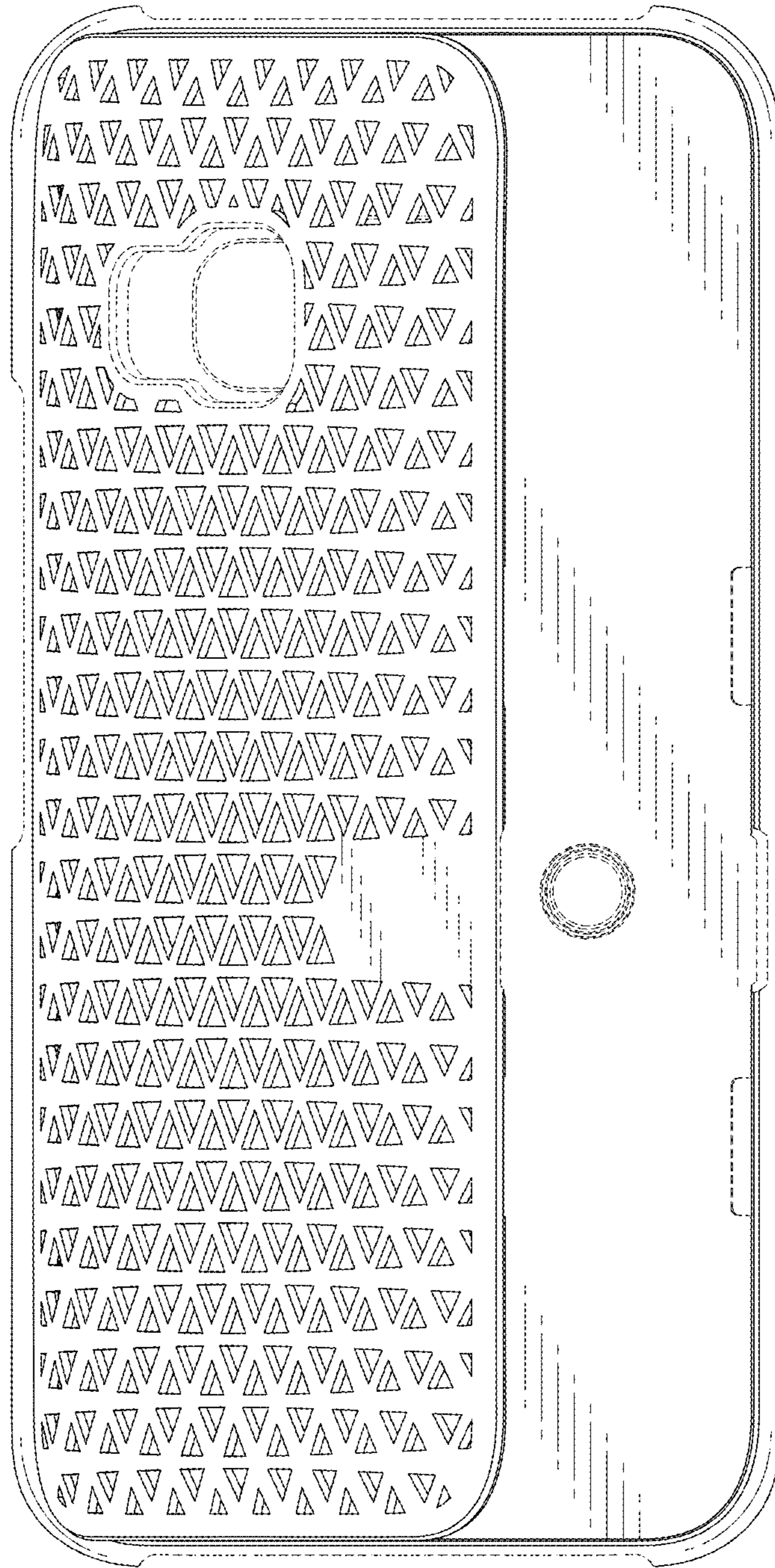

FIG. 2

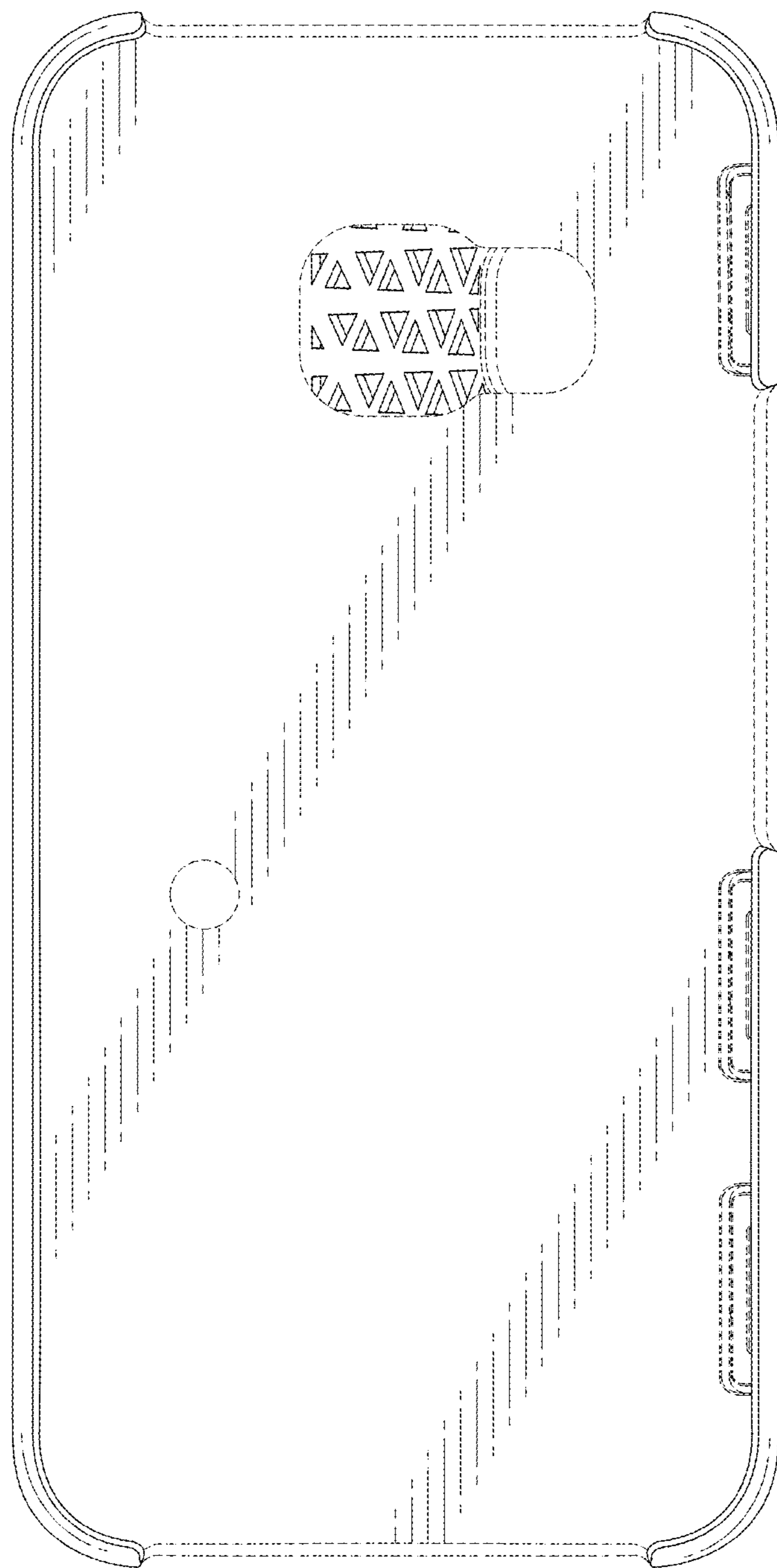

FIG. 3

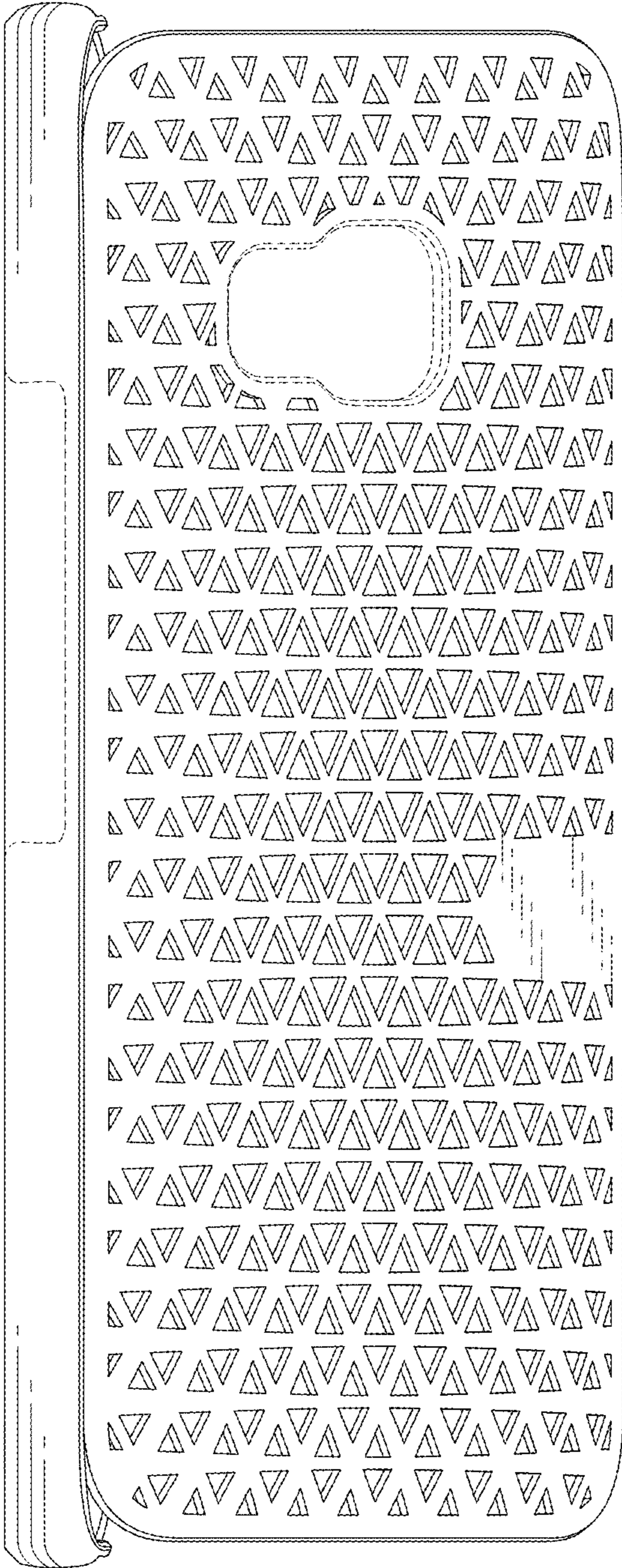

FIG. 4

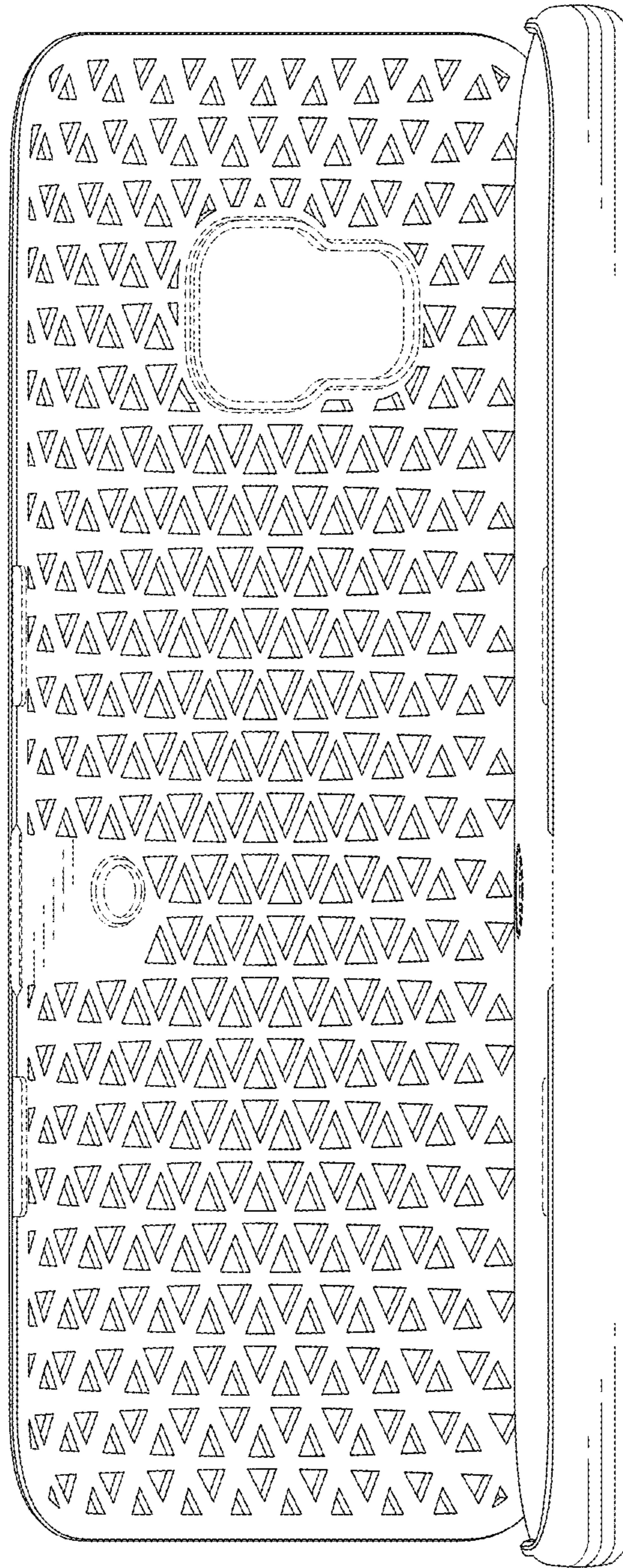

FIG. 5

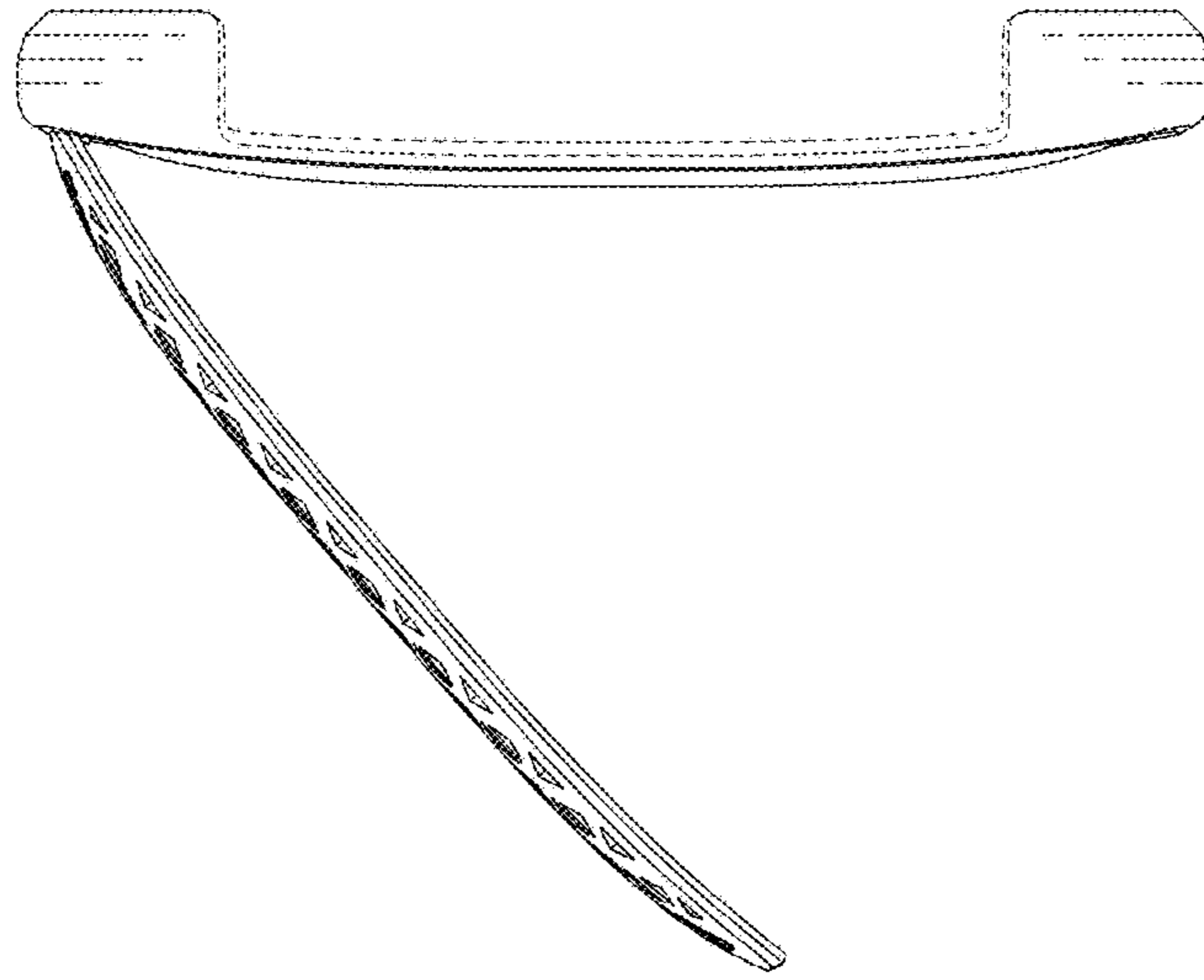

FIG. 6

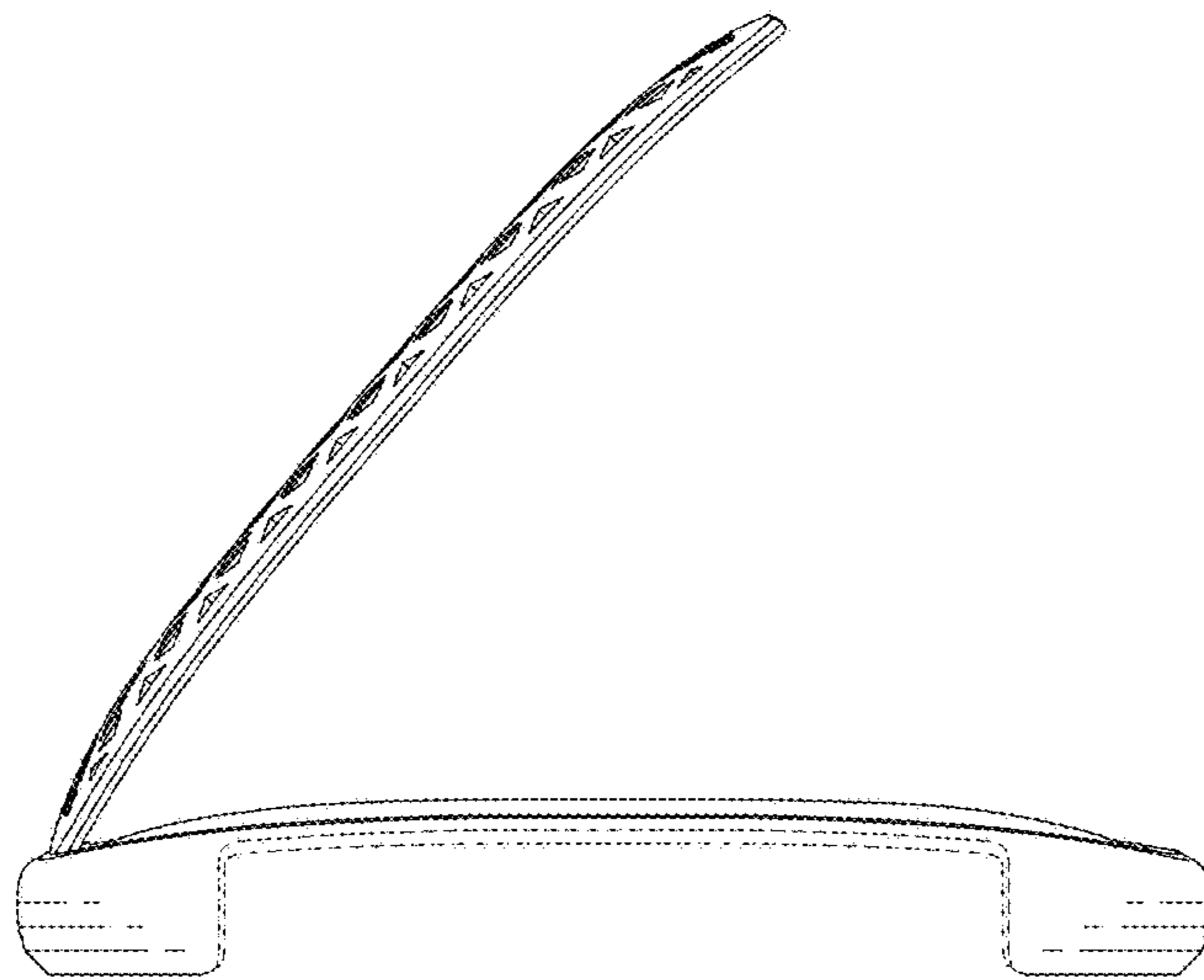

FIG. 7

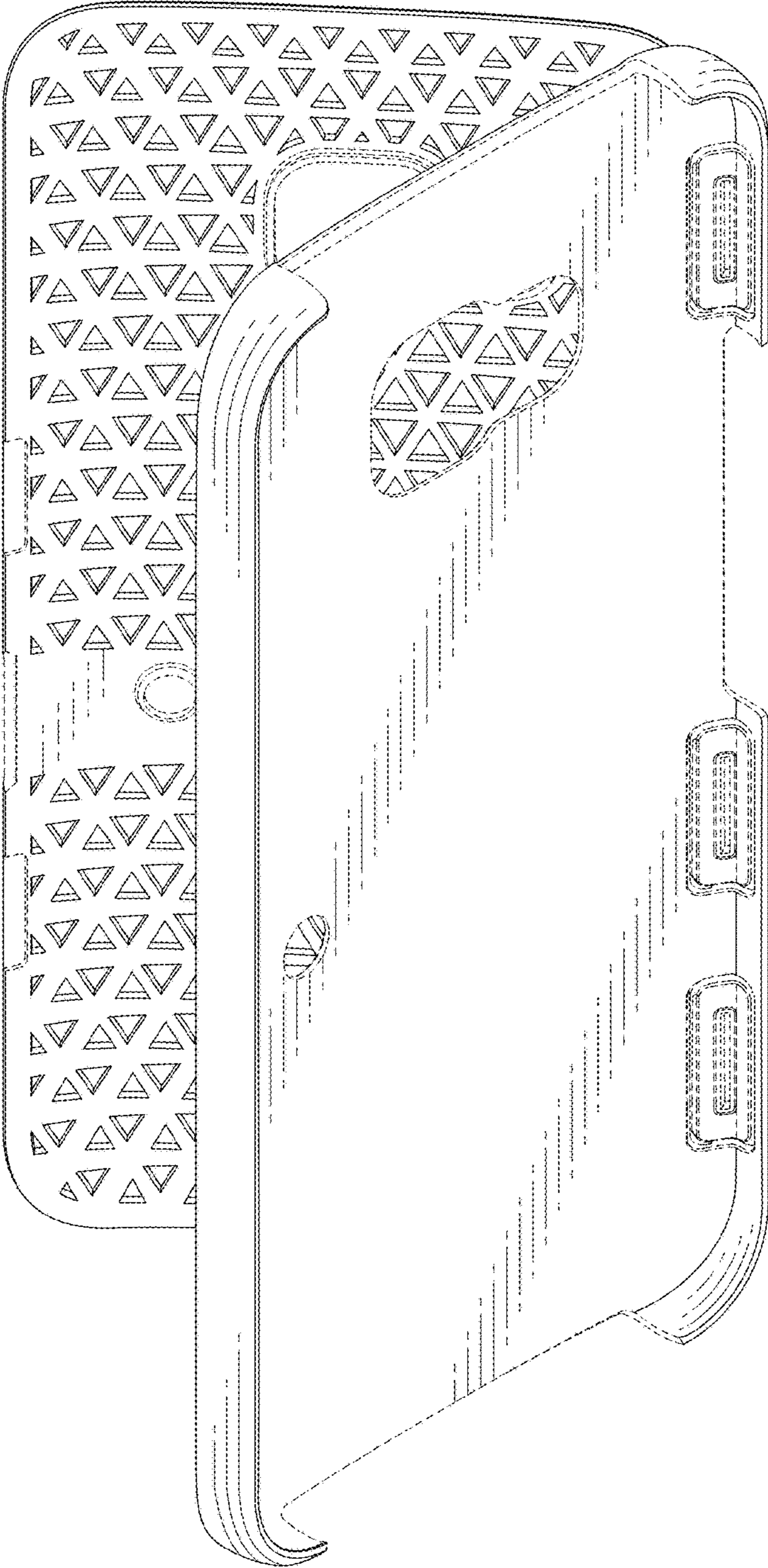

FIG. 8

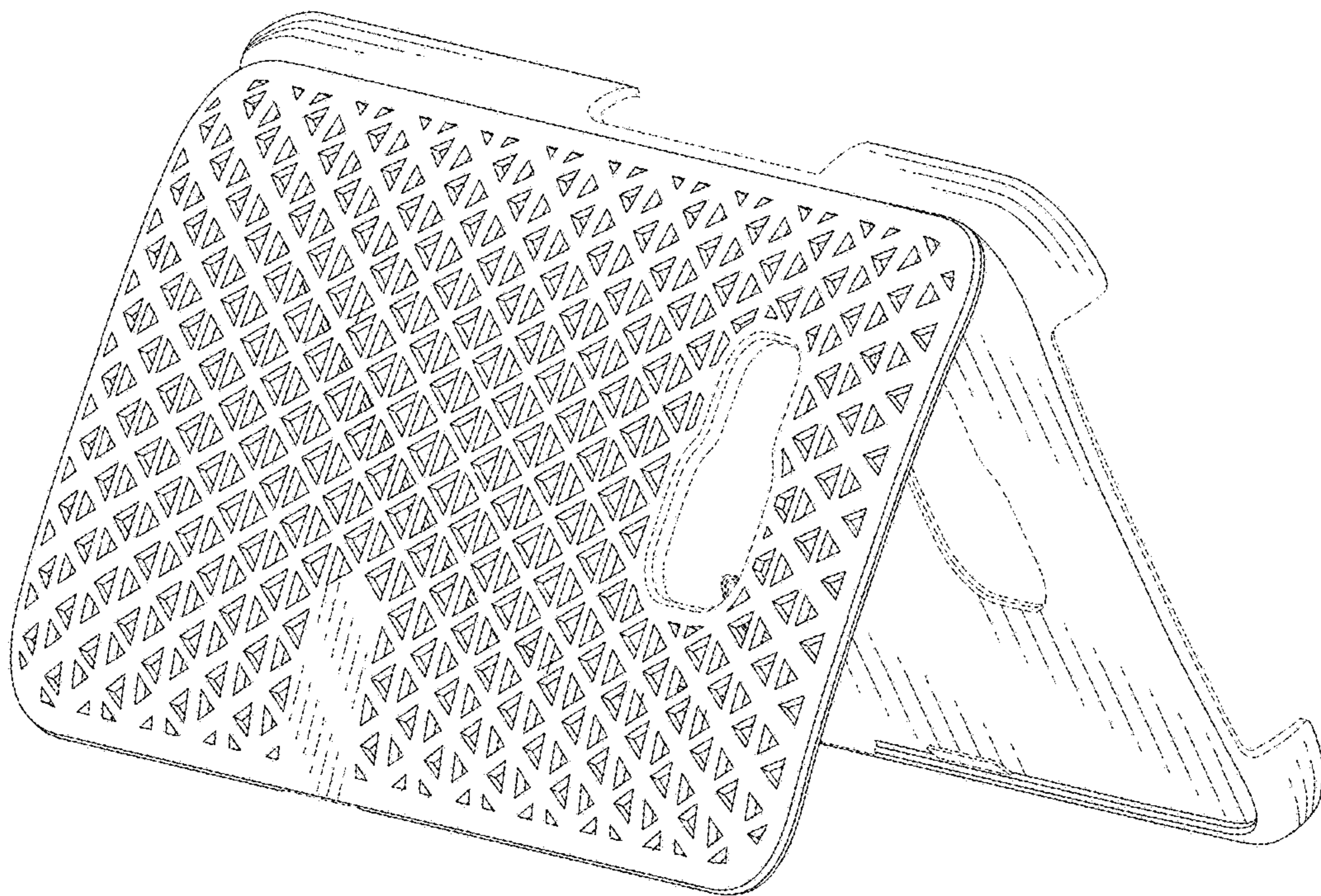

FIG. 9

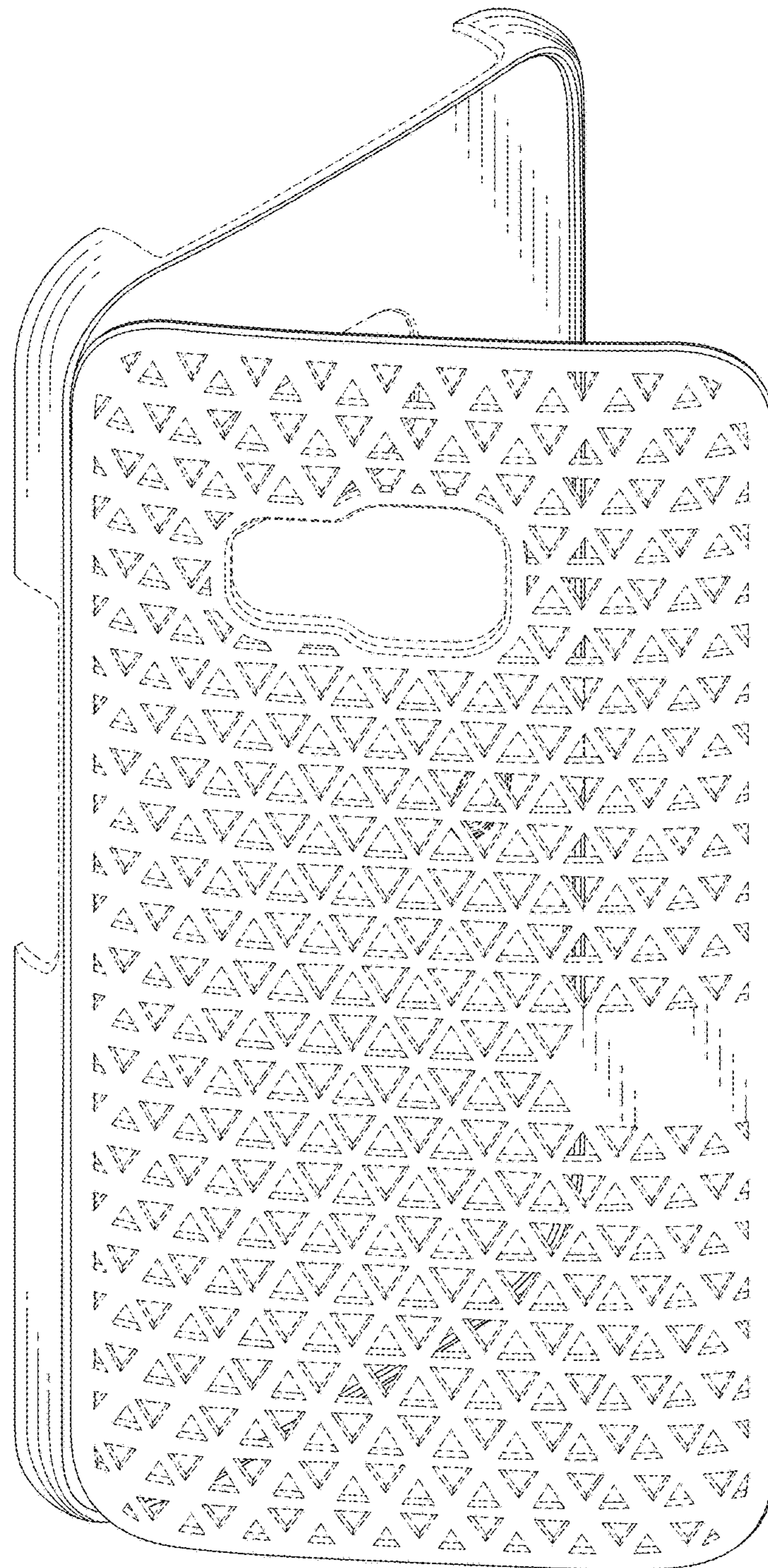

FIG. 10

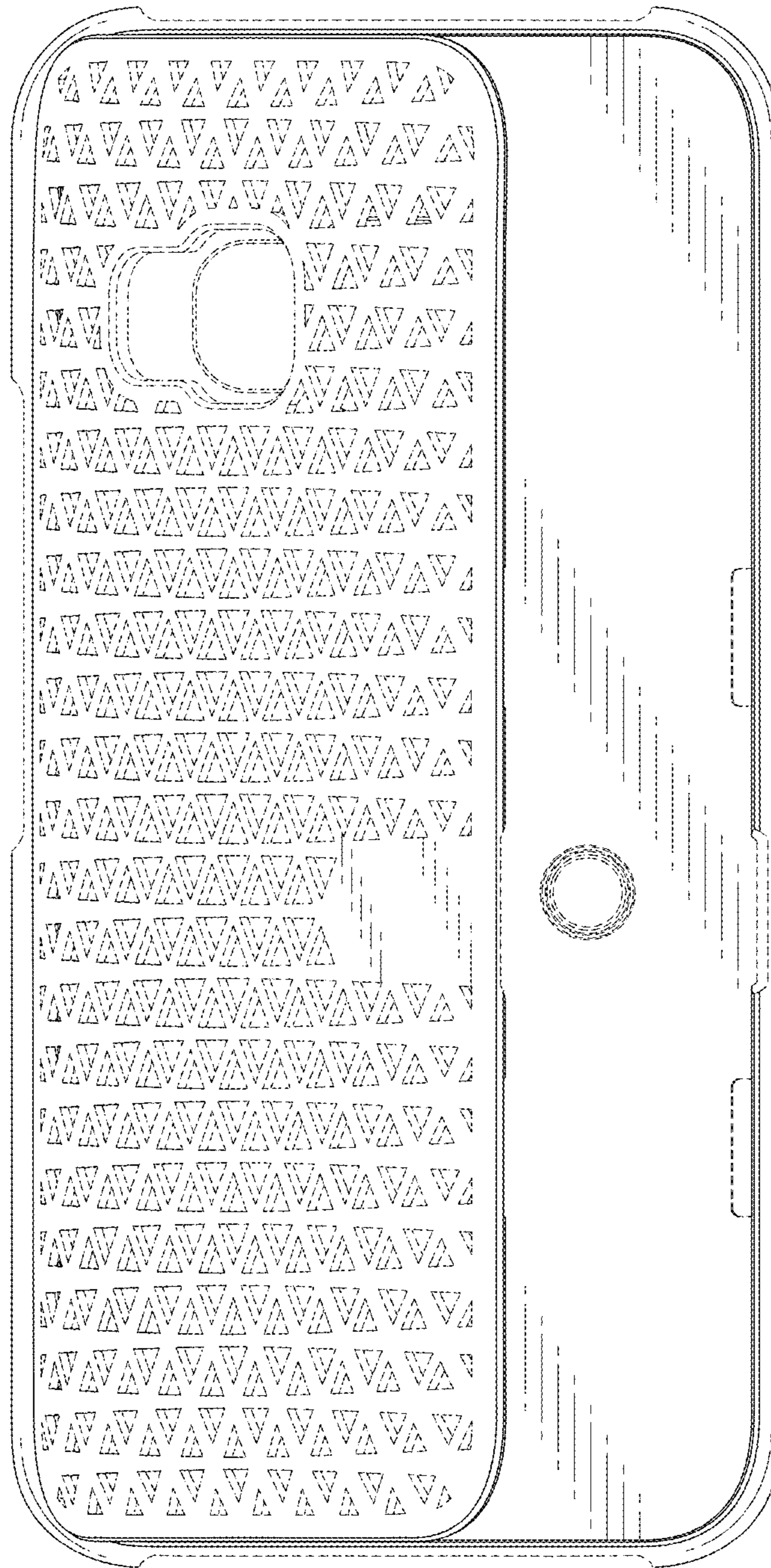

FIG. 11

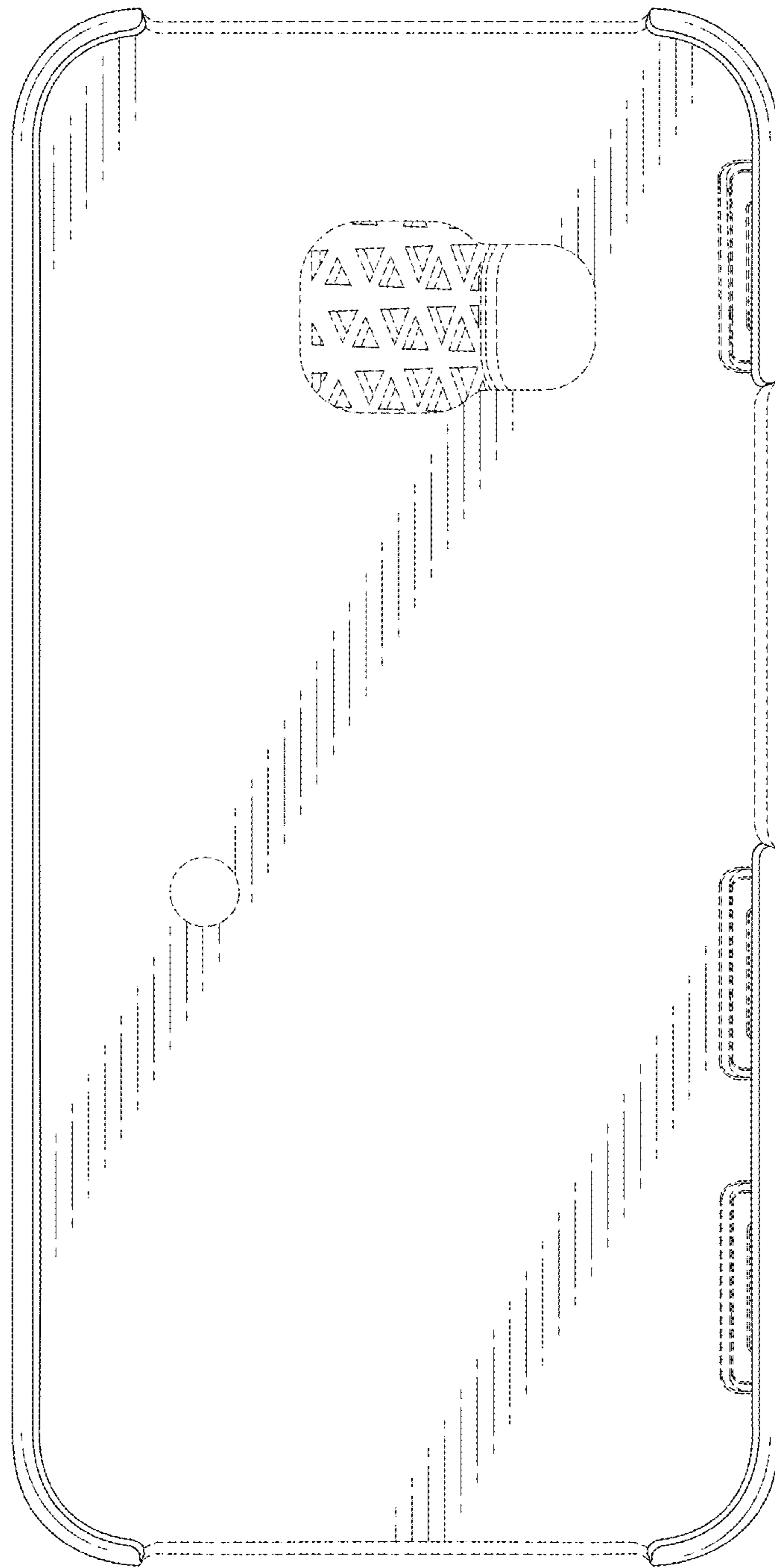

FIG. 12

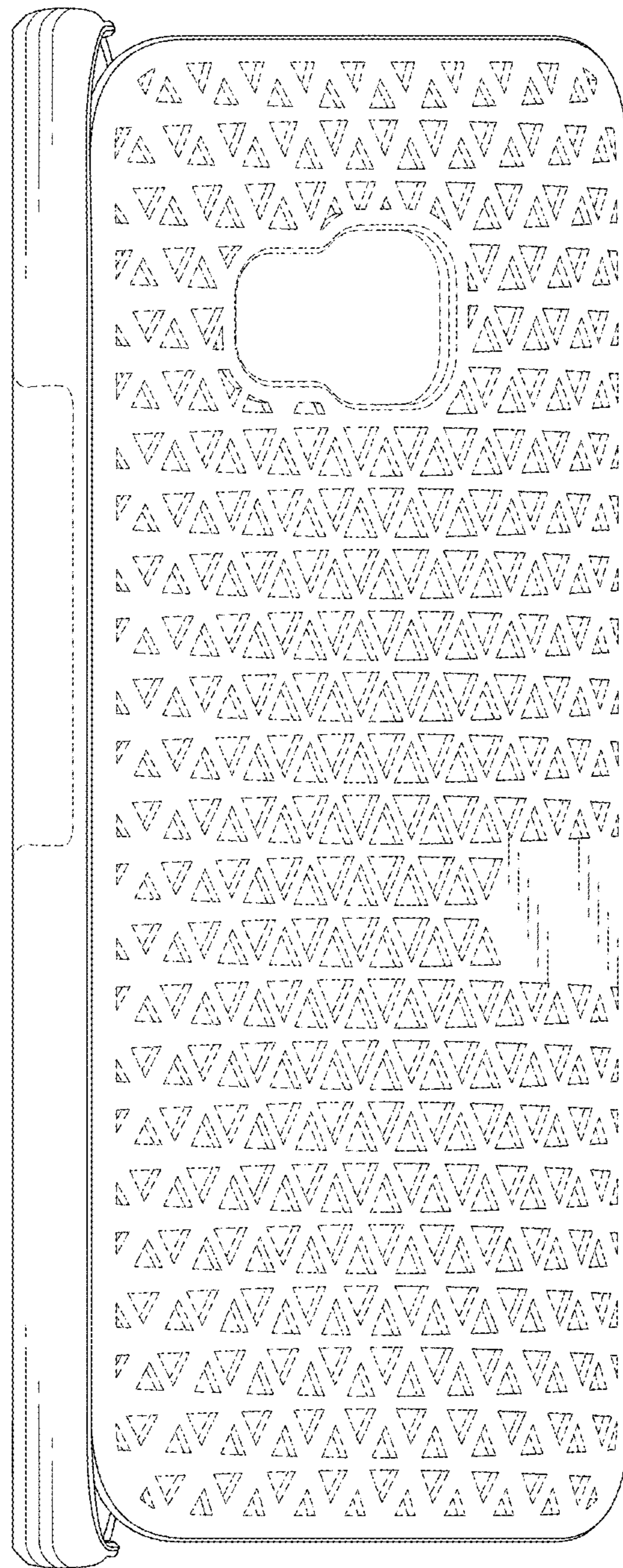

FIG. 13

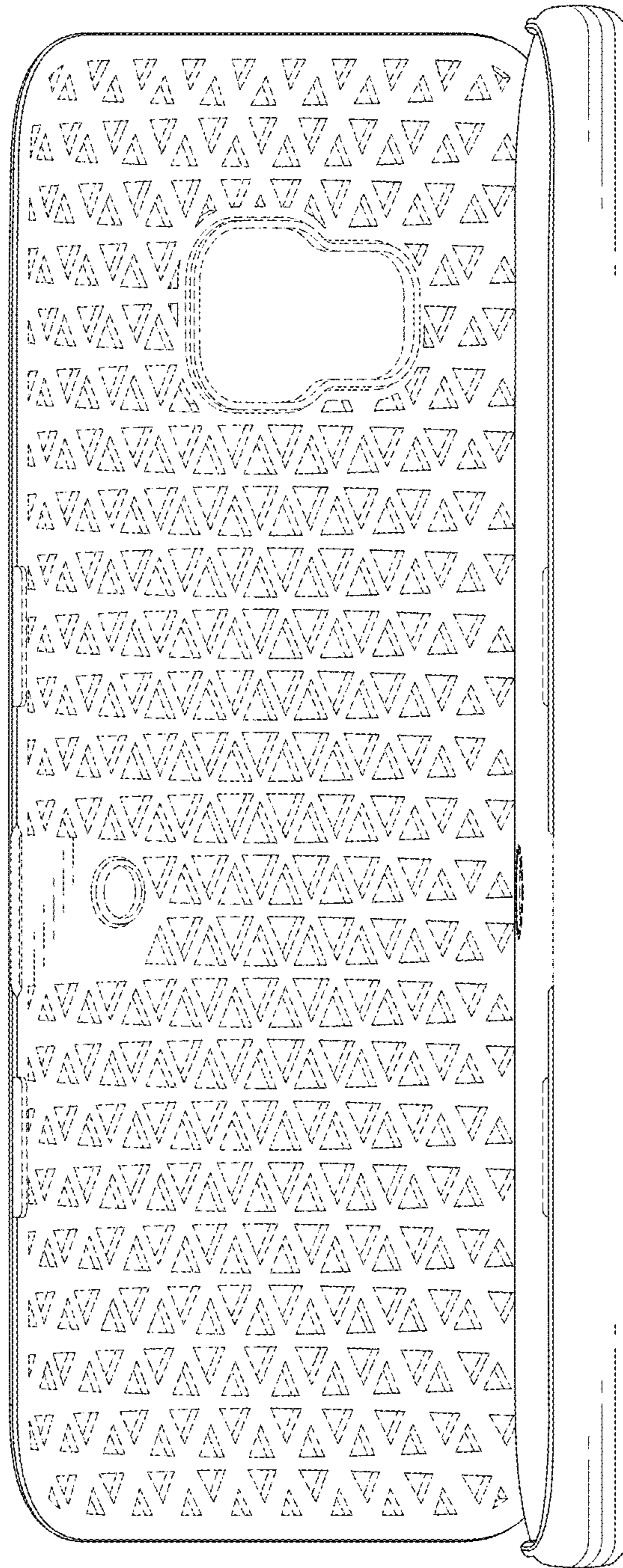

FIG. 14

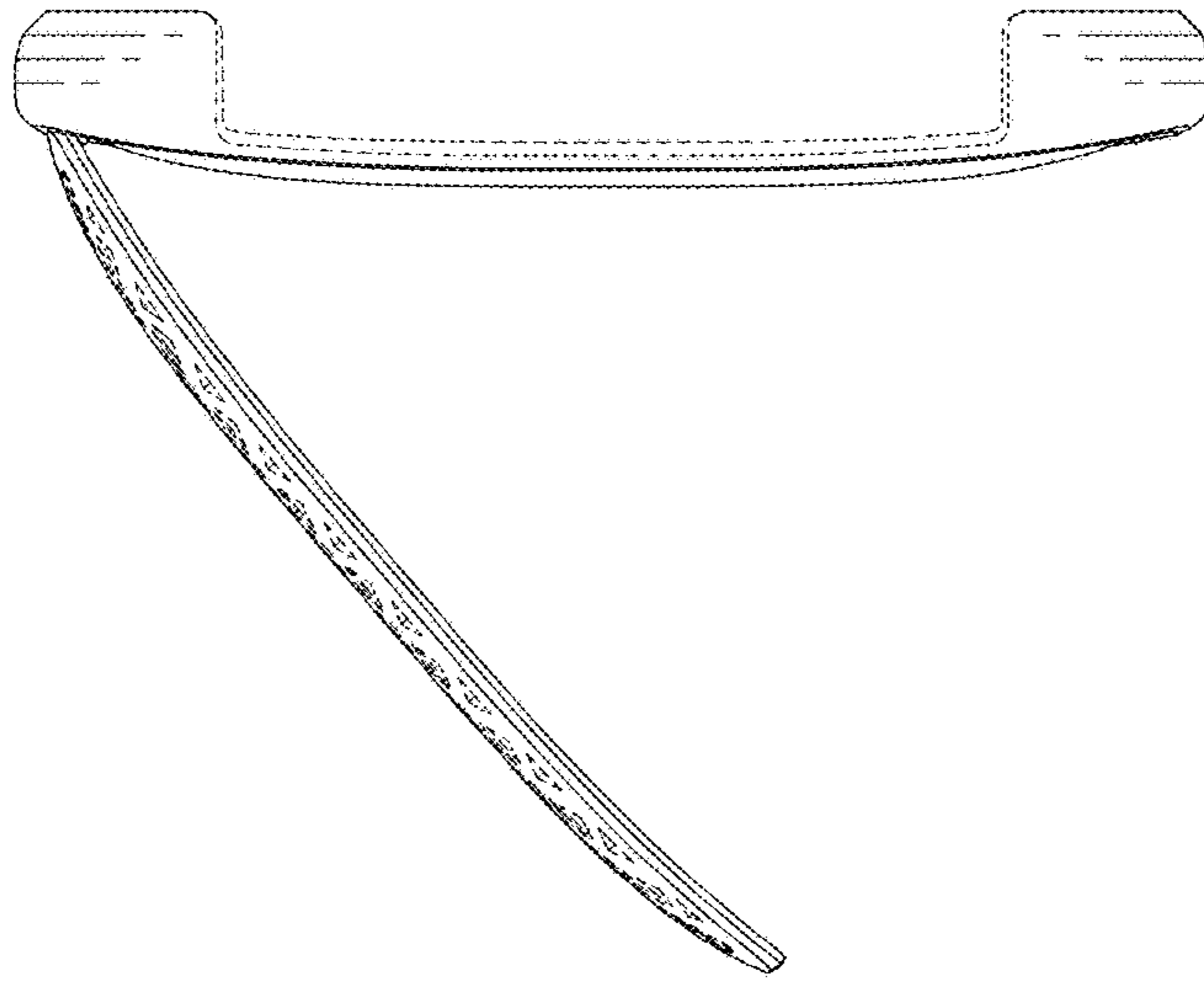

FIG. 15



FIG. 16

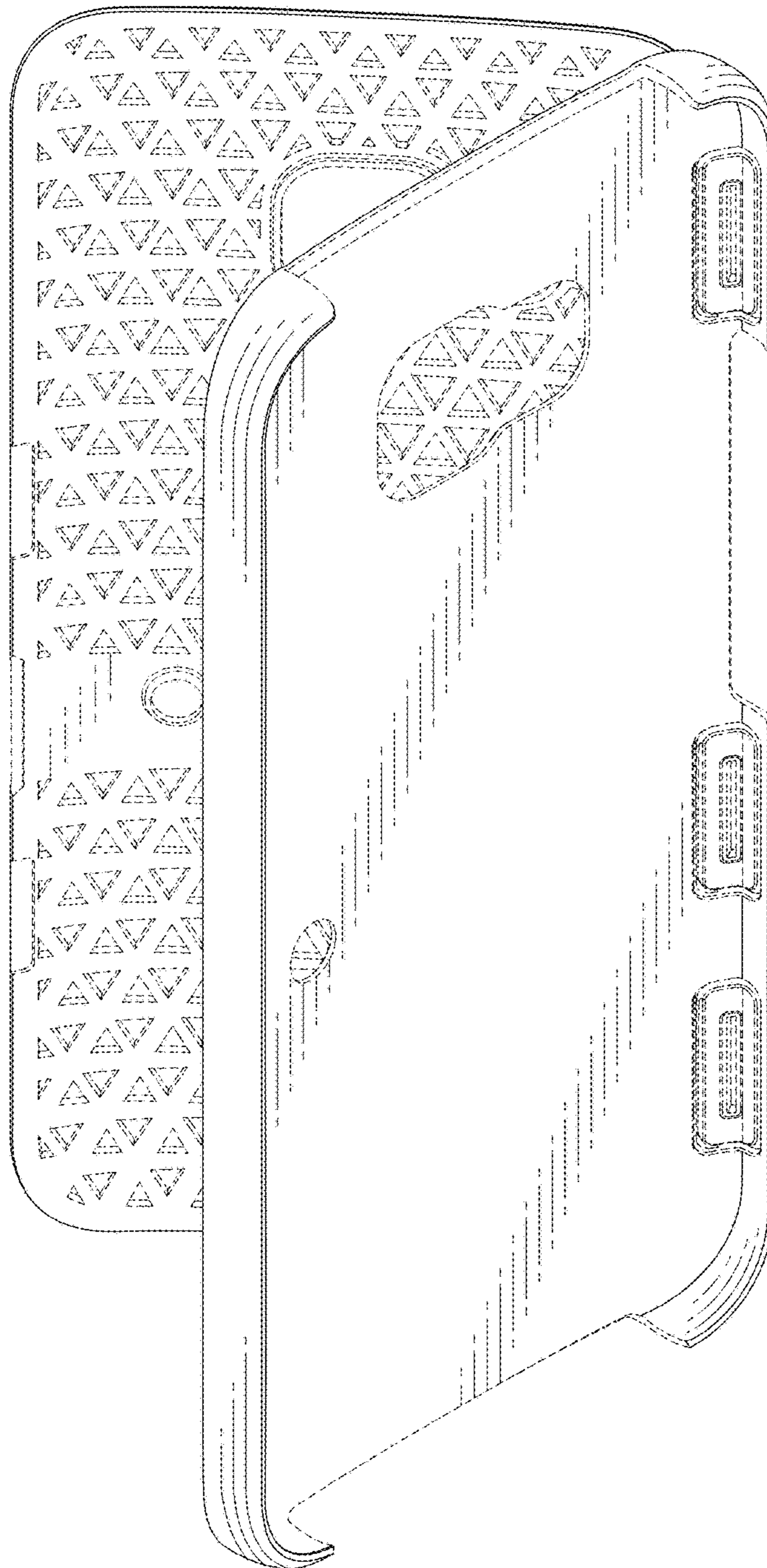

FIG. 17

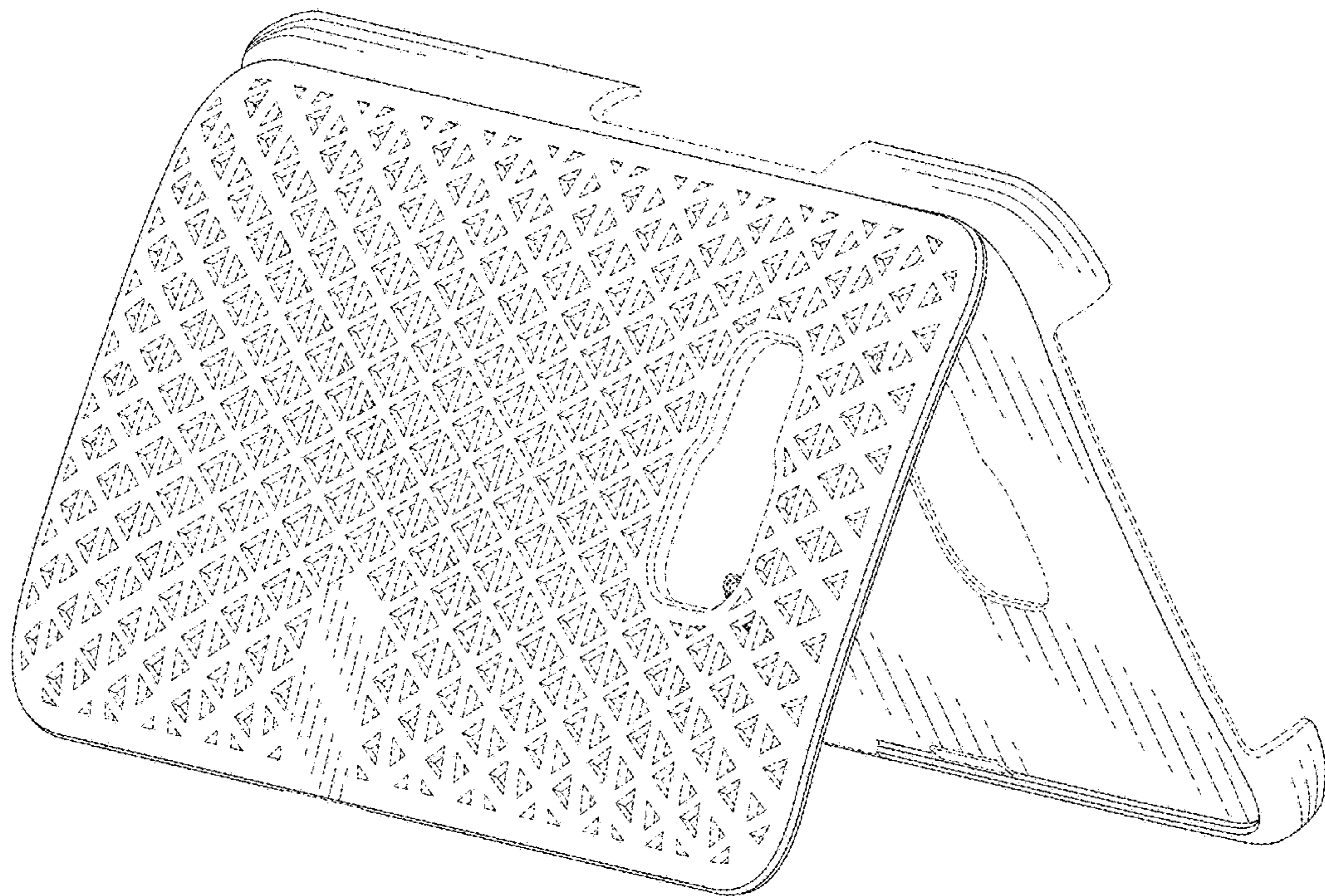

FIG. 18