



US00D791024S

(12) **United States Design Patent**
Mazar

(10) **Patent No.:** **US D791,024 S**

(45) **Date of Patent:** **** Jul. 4, 2017**

(54) **VEHICLE CHILD SEAT CONVERTIBLE TO STROLLER**

(71) Applicant: **Doona Holdings Ltd.**, Quarry Bay (HK)

(72) Inventor: **Yoav Mazar**, Herzeliya (IL)

(73) Assignee: **DOONA HOLDINGS LTD.**, Quarry Bay (HK)

(**) Term: **14 Years**

(21) Appl. No.: **29/496,918**

(22) Filed: **Jul. 18, 2014**

(30) **Foreign Application Priority Data**

Jan. 20, 2014 (EM) 002387639

(51) **LOC (10) Cl.** **12-12**

(52) **U.S. Cl.**
USPC **D12/129**

(58) **Field of Classification Search**
USPC D12/128-133; D6/333
CPC B62B 7/00-7/04; B62B 9/00-9/28; A47C 4/54; A47C 7/021; A47C 31/11
See application file for complete search history.

(56) **References Cited**

U.S. PATENT DOCUMENTS

D308,656 S * 6/1990 Takahashi D12/129
D342,614 S * 12/1993 Collins D6/333
D423,416 S * 4/2000 Shepherd D12/129

D482,641 S * 11/2003 Hansen D12/129
D495,978 S * 9/2004 Carpenter D12/129
D508,220 S * 8/2005 Spriggs D12/129
D526,601 S * 8/2006 Oxseth D12/129
D527,316 S * 8/2006 Oxseth D12/129
D602,819 S * 10/2009 van Buul D12/129
D631,402 S * 1/2011 Bagwell D12/129
D654,409 S * 2/2012 Angelfoss D12/133
D661,624 S * 6/2012 Stopp D12/129
D699,635 S * 2/2014 Slotteroy D12/133

* cited by examiner

Primary Examiner — Charles Hanson

(74) *Attorney, Agent, or Firm* — Vorys, Sater, Seymour & Pease LLP

(57) **CLAIM**

The ornamental design for vehicle child seat convertible to stroller, as shown and described.

DESCRIPTION

FIG. 1 is a perspective view of a vehicle child seat convertible to stroller with the handle and wheels in a retracted position;
FIG. 2 is a front view thereof;
FIG. 3 is a right side view thereof;
FIG. 4 is a left side view thereof;
FIG. 5 is a perspective view thereof, with the handle and wheels in an extended position;
FIG. 6 is a front view thereof;
FIG. 7 is a left side view thereof, with the handle retracted;
FIG. 8 is a left side view thereof, with the handle extended; and,
FIG. 9 is a top view thereof, with the handle retracted.

1 Claim, 9 Drawing Sheets

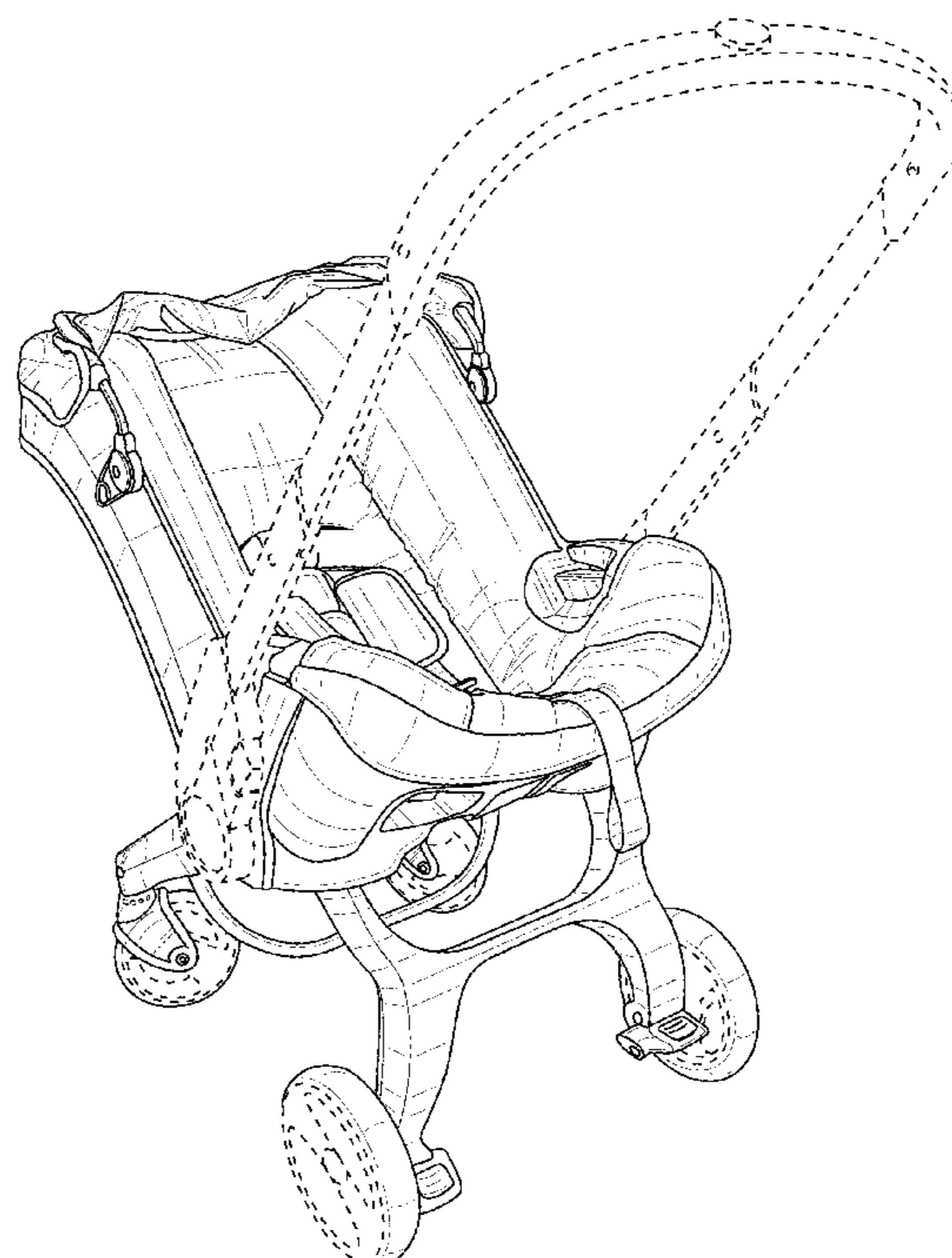

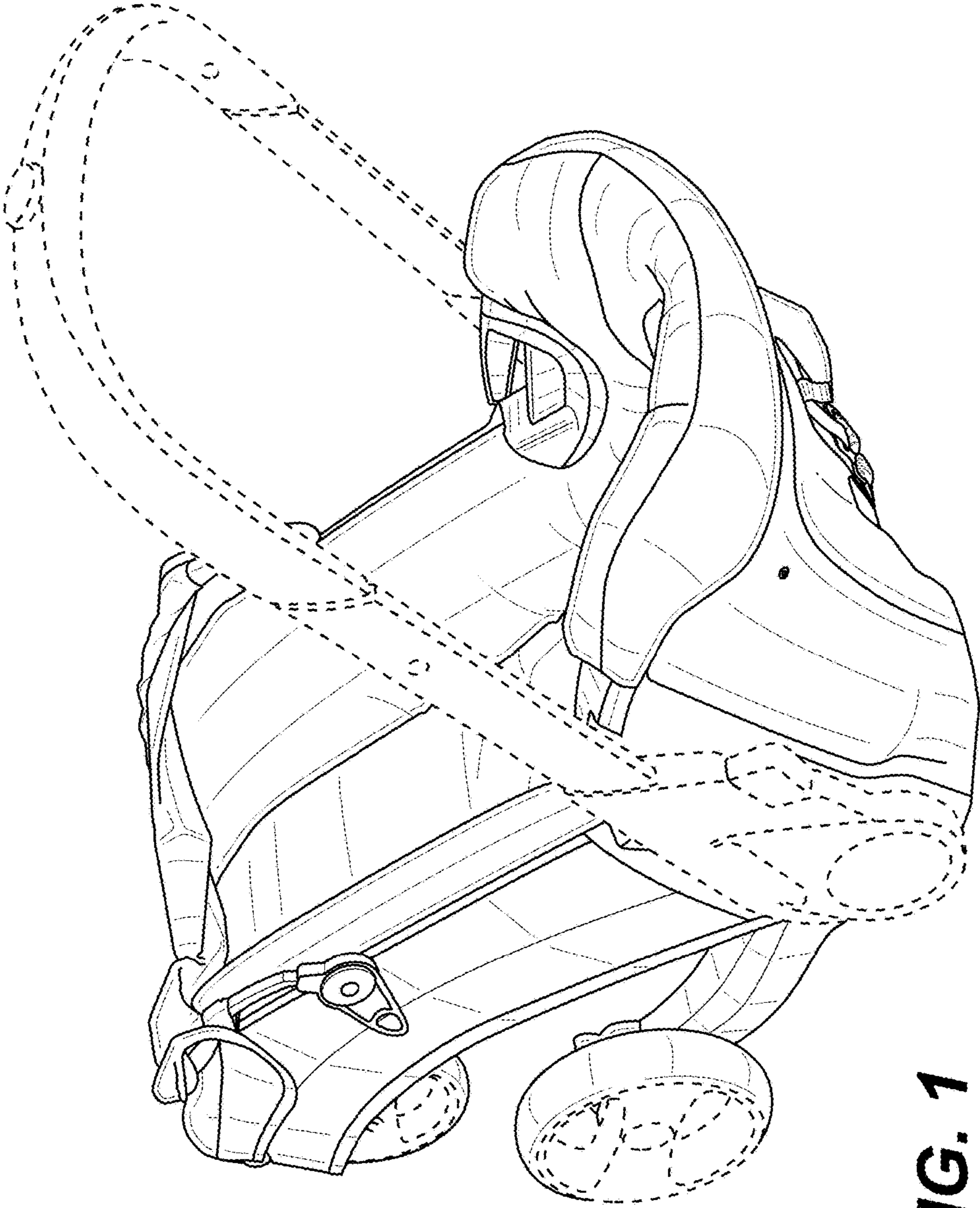

FIG. 1

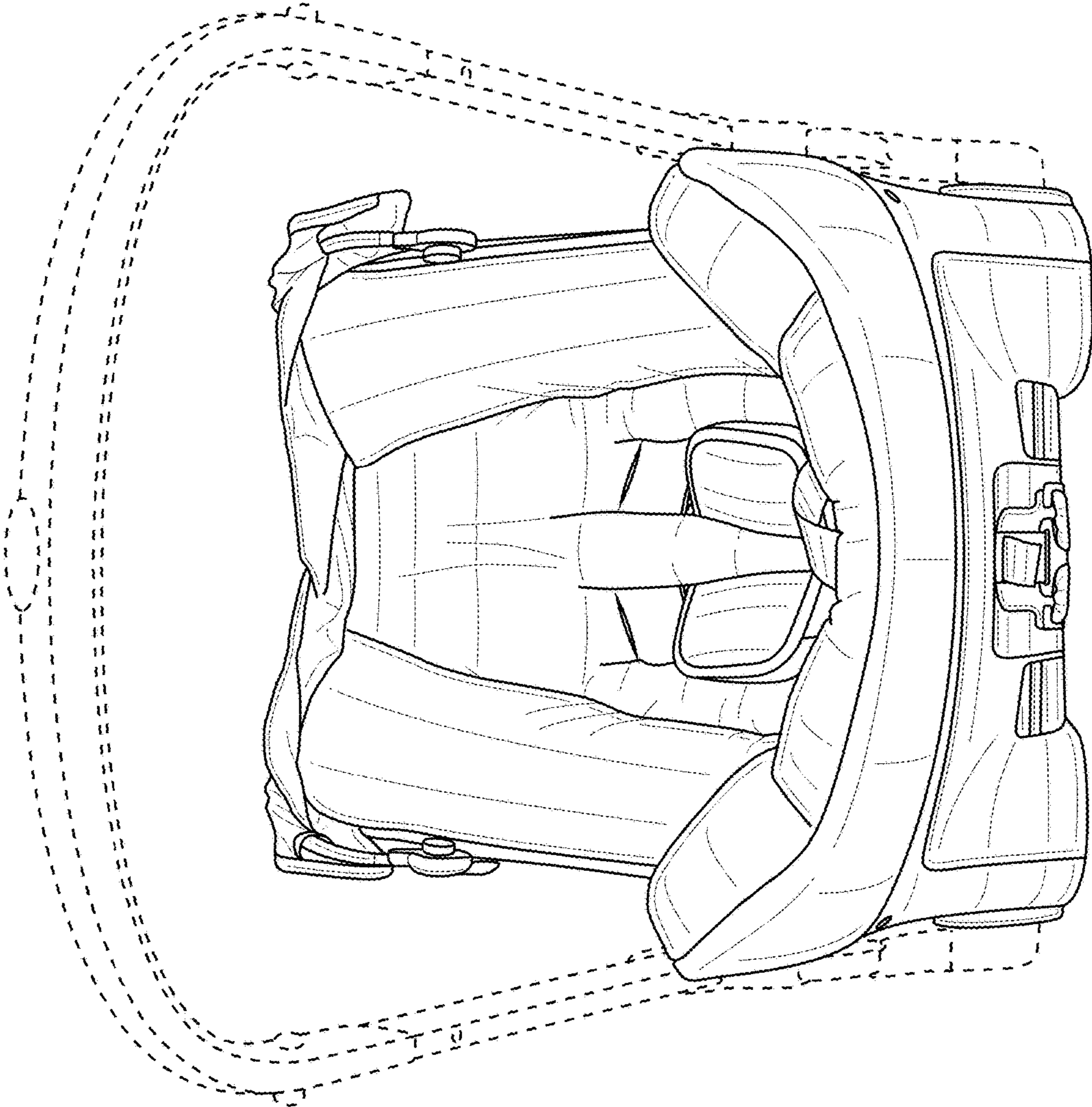

FIG. 2

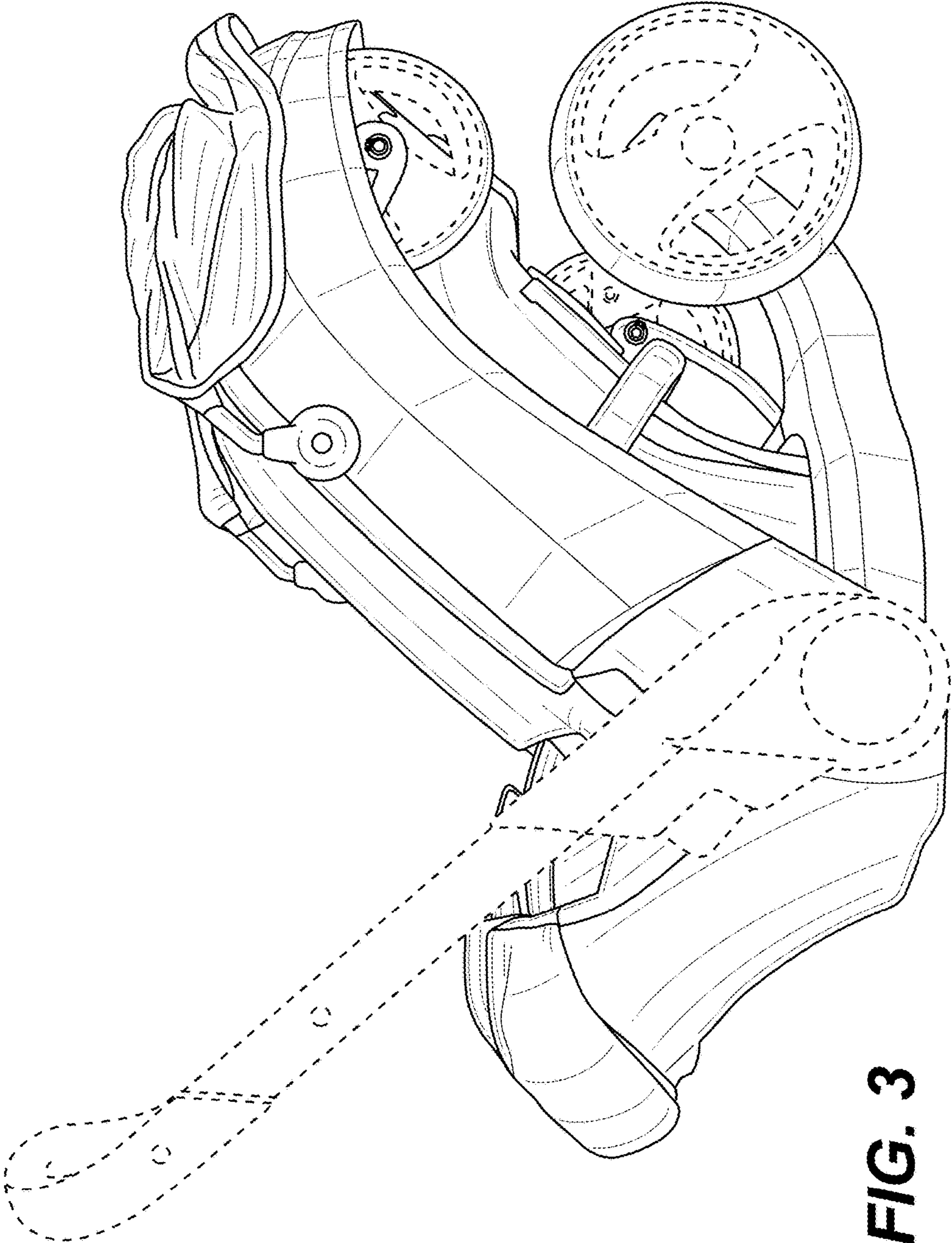

FIG. 3

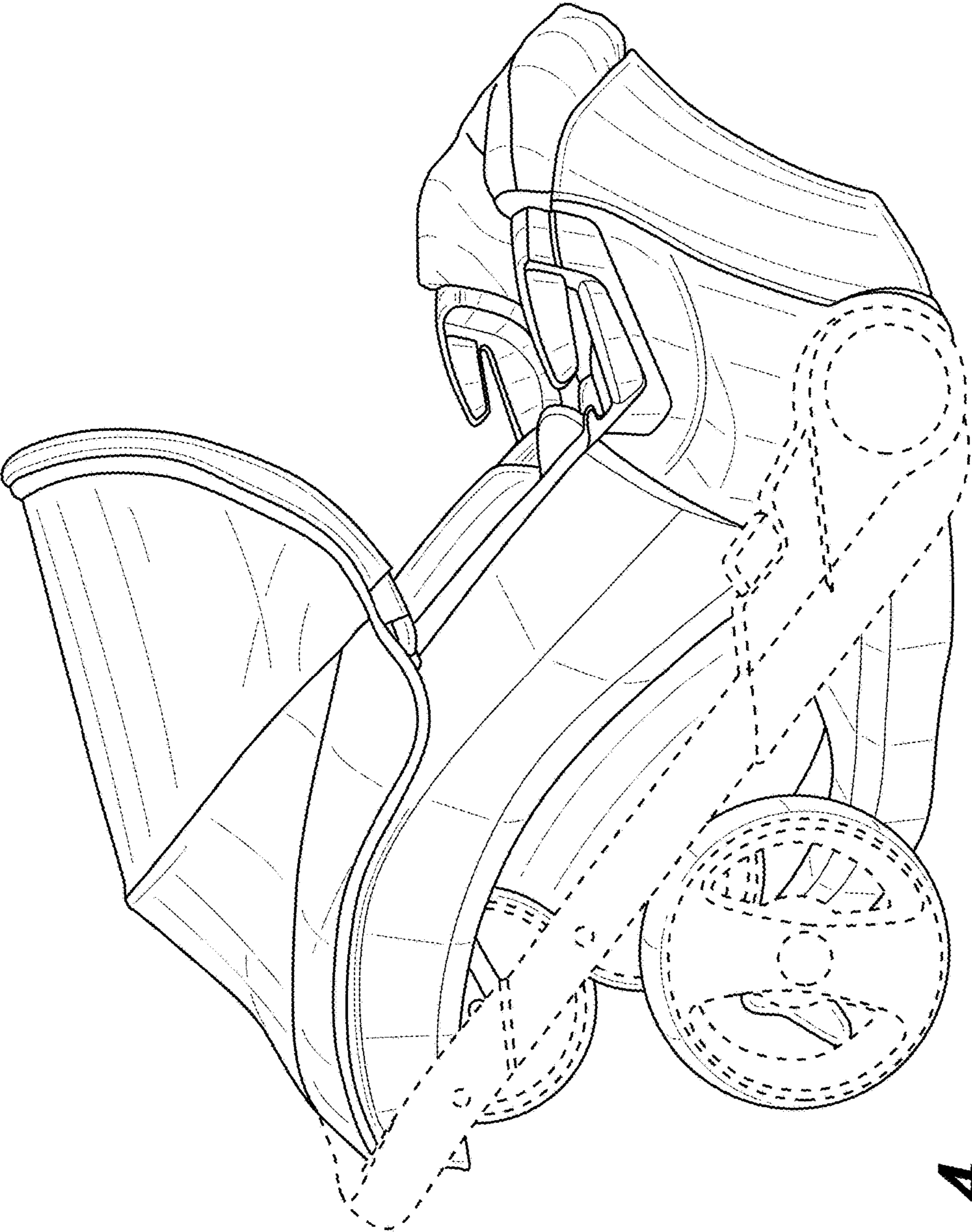

FIG. 4

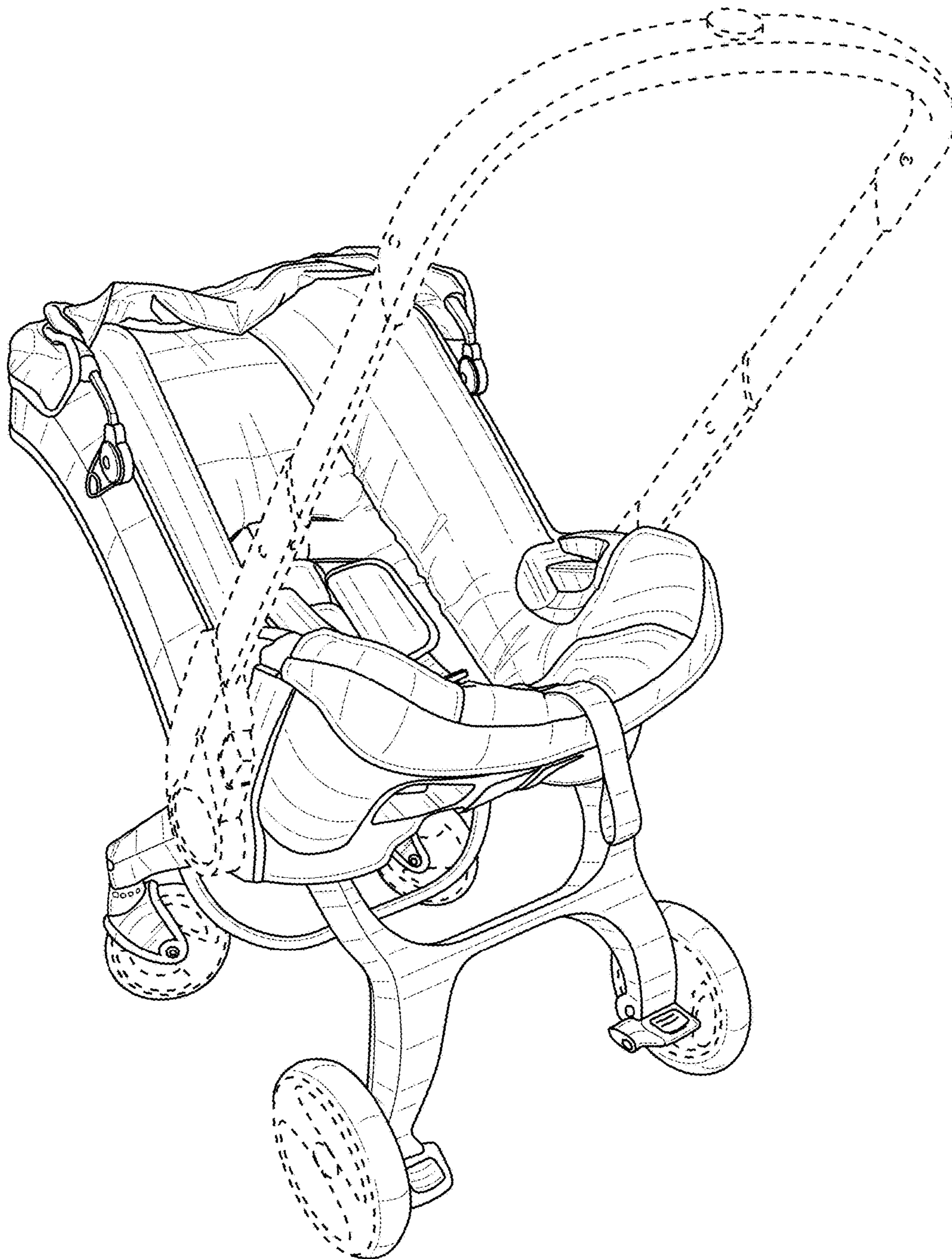

FIG. 5

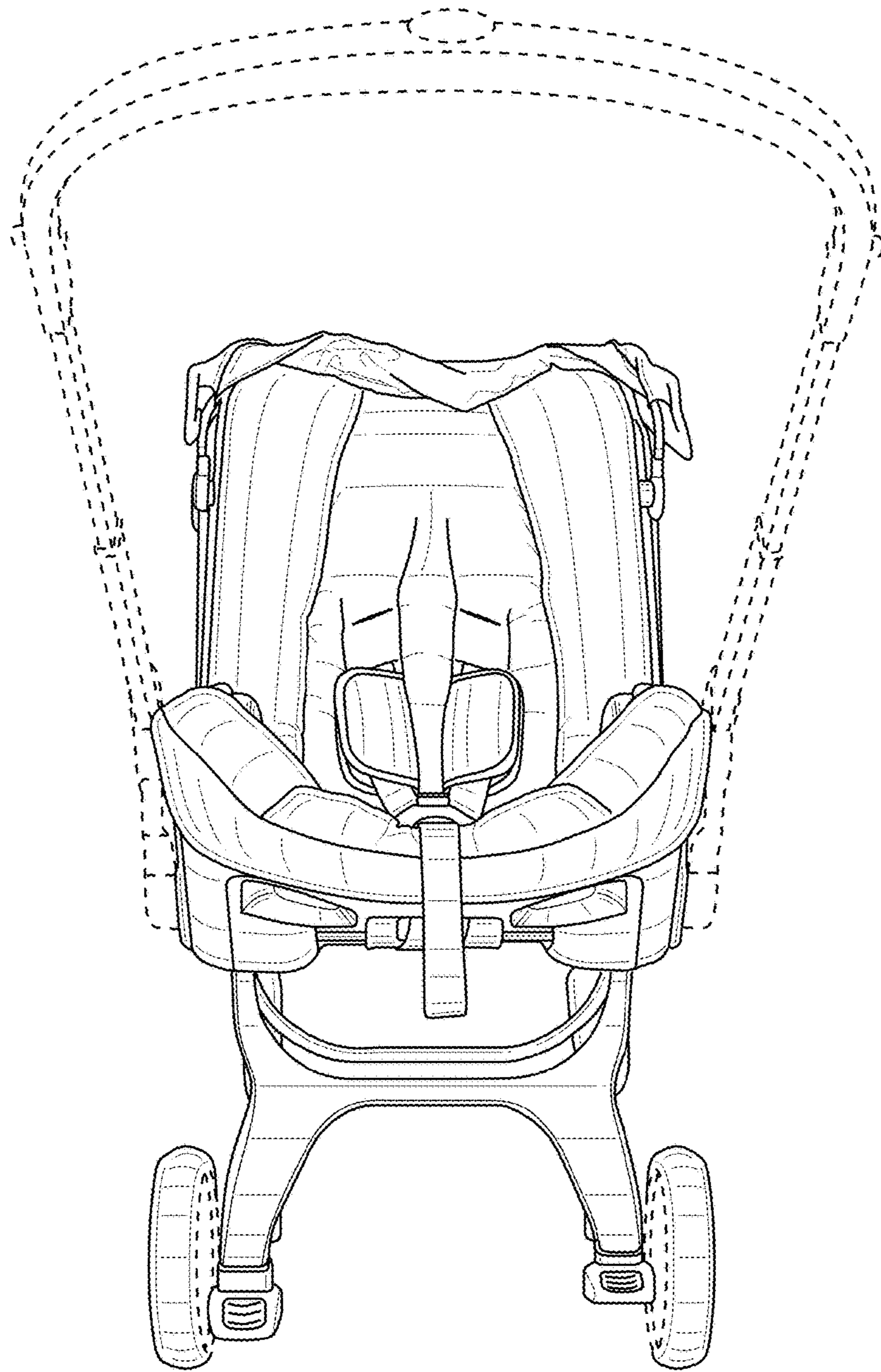

FIG. 6

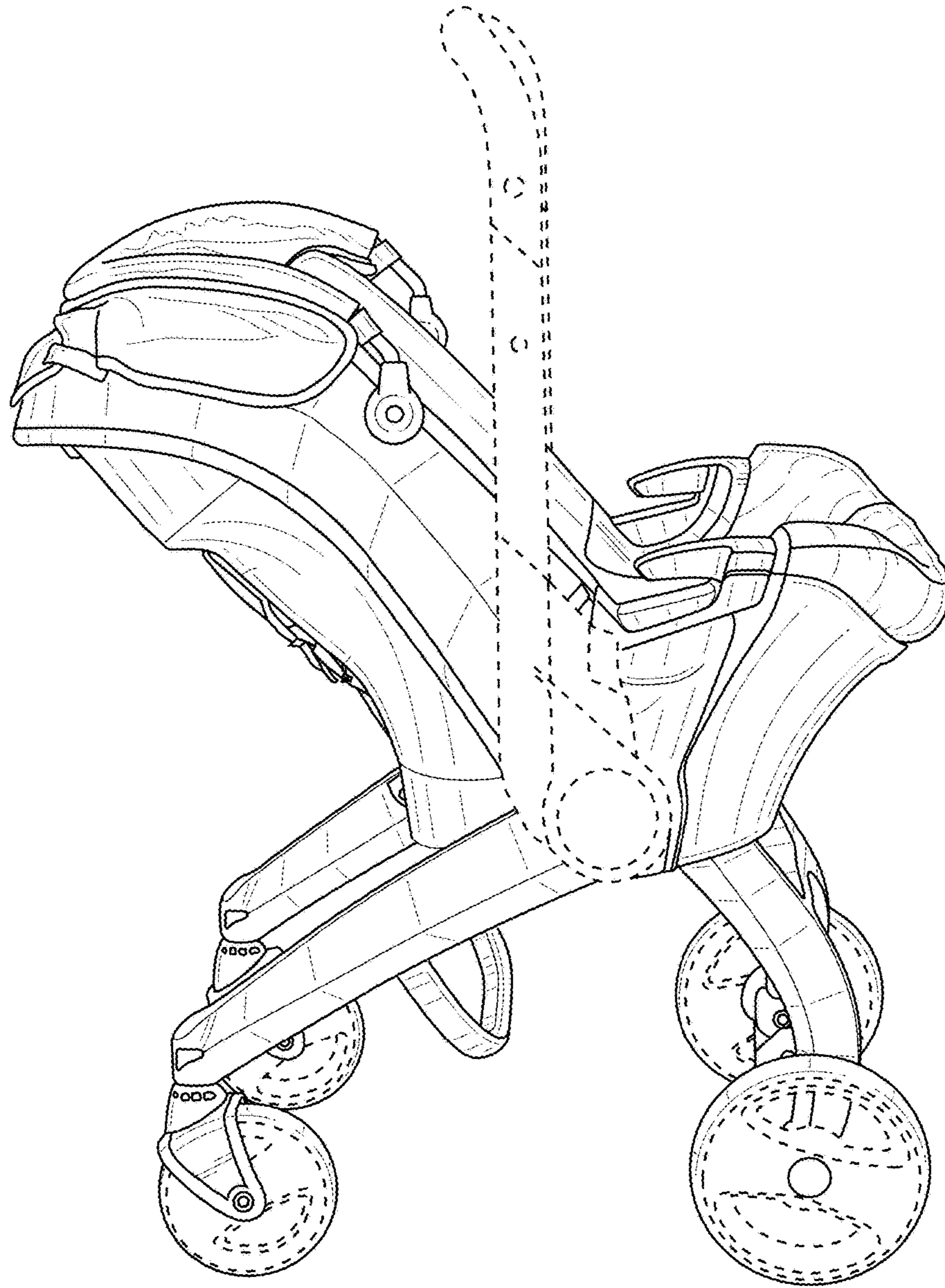

FIG. 7

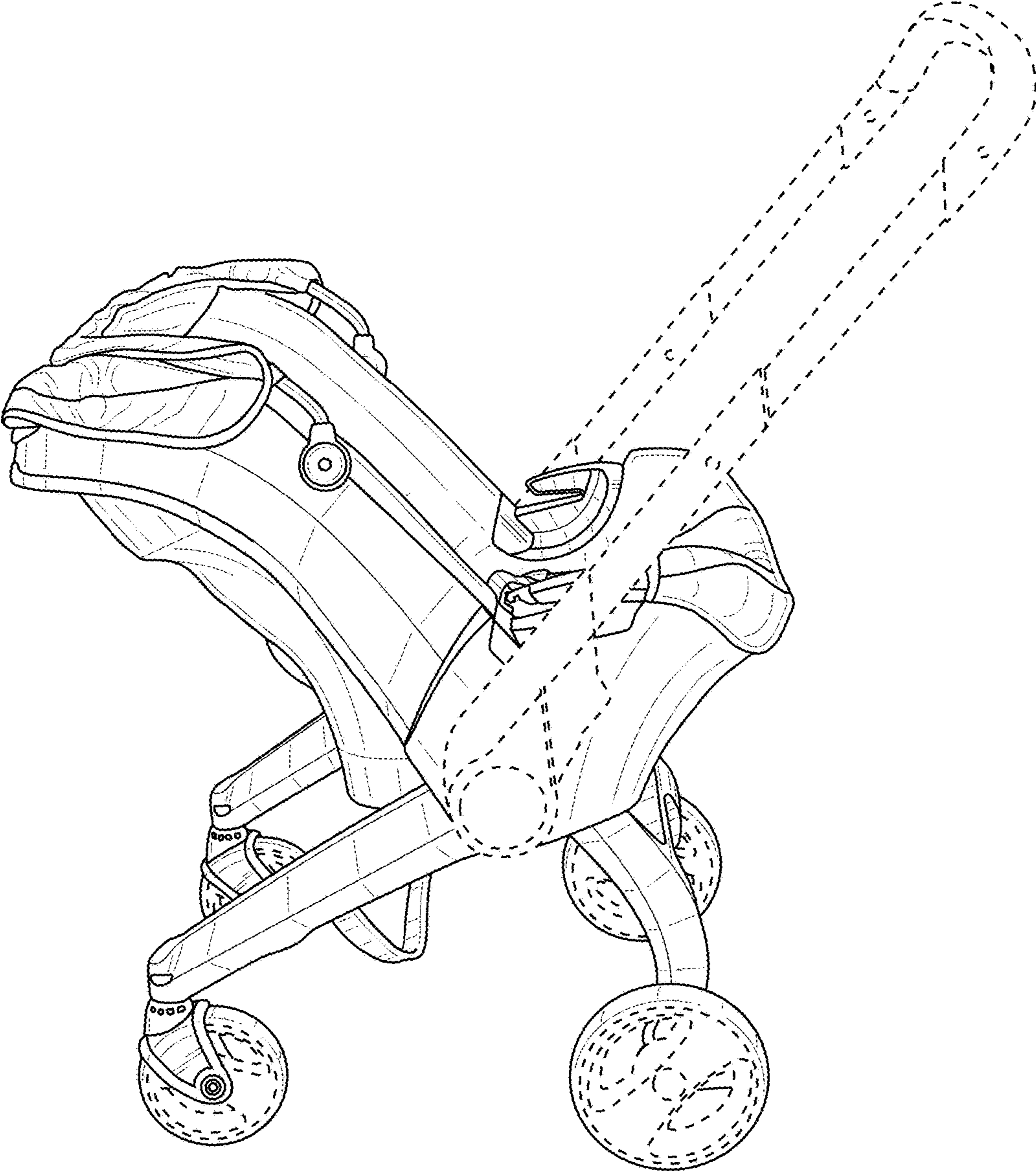

FIG. 8

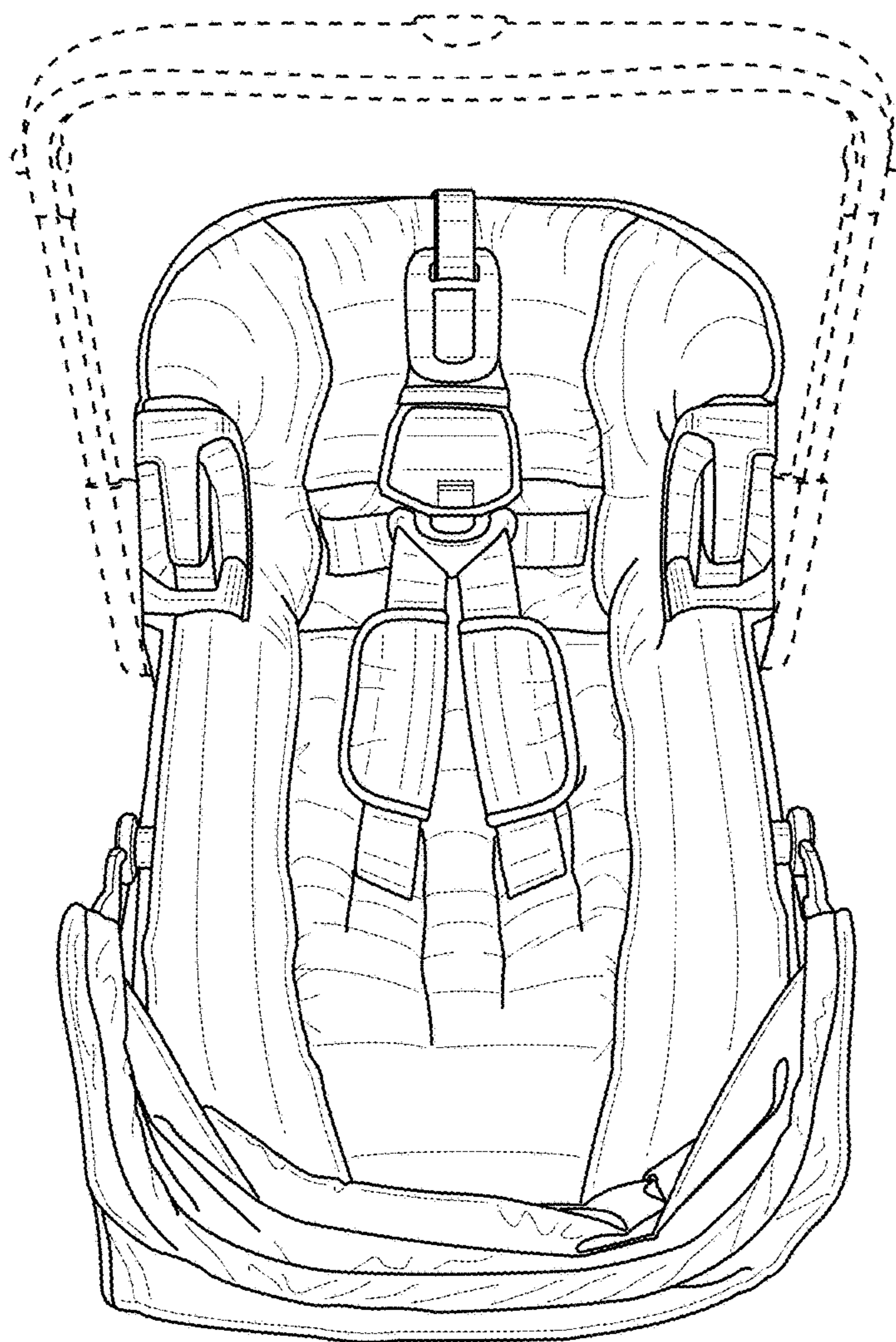

FIG. 9