



US00D790971S

(12) **United States Design Patent** (10) **Patent No.:** **US D790,971 S**
Bos et al. (45) **Date of Patent:** **** Jul. 4, 2017**

(54) **BOTTLE**
(71) Applicant: **Reckitt Benckiser LLC**, Parsippany, NJ (US)
(72) Inventors: **Randy Bos**, Eindhoven (NL); **Teun Franciscus Van Wetten**, Eindhoven (NL)
(73) Assignee: **RECKITT BENCKISER LLC**, Parsippany, NJ (US)

D350,484 S * 9/1994 Addis D9/526
D378,573 S * 3/1997 Sherman D9/526
D383,678 S * 9/1997 Syrek D9/526
D389,065 S * 1/1998 Goettner D9/526
D392,568 S * 3/1998 Goettner D9/526
D406,063 S * 2/1999 Vangramberen D9/526
D481,637 S * 11/2003 Desouza D9/520
D553,501 S * 10/2007 Arnett D9/526
D553,990 S * 10/2007 Muhlhausen D9/447
D585,286 S * 1/2009 Rosinski D9/526
D622,595 S * 8/2010 Rousselet D9/526
D739,748 S * 9/2015 Van Wetten D9/449
D758,882 S * 6/2016 Bruining D9/524

(Continued)

(**) Term: **15 Years**

(21) Appl. No.: **29/550,965**

(22) Filed: **Jan. 8, 2016**

(30) **Foreign Application Priority Data**

Aug. 6, 2015 (EP) 002750687

(51) **LOC (10) Cl.** **09-01**

(52) **U.S. Cl.**
USPC **D9/526**; D9/563; D9/565; D9/574

(58) **Field of Classification Search**
USPC D7/300-322, 396.2, 509-511, 523, 589, D7/598, 612, 615, 619.1; D9/500-575; 215/40-55, 316-354, 370-385; 220/574-575

CPC . B05B 11/0089; B29D 23/20; B29L 2023/20; B65D 1/00; B65D 1/02; B65D 1/0223; B65D 1/023; B65D 1/0276; B65D 47/0857; B65D 81/3288; F04B 9/14
See application file for complete search history.

(56) **References Cited**

U.S. PATENT DOCUMENTS

D213,670 S * 4/1969 Waddington et al. D24/110
D307,546 S * 5/1990 Lyons D9/526
D307,714 S * 5/1990 Rosenberg D9/435
D310,026 S * 8/1990 Verebelyi D9/520

OTHER PUBLICATIONS

“Toilet cleaner bottle with black cap.” 123rf.com. Date not available. Accessed Apr. 26, 2017. Available online at URL: <https://www.123rf.com/photo_22767141_toilet-cleaner-bottle-with-black-cap.html>.*

(Continued)

Primary Examiner — Cathron Brooks
Assistant Examiner — Christian P. McClean
(74) *Attorney, Agent, or Firm* — Norris McLaughlin & Marcus PA

(57) **CLAIM**

The ornamental design for a bottle, as shown and described.

DESCRIPTION

FIG. 1 is a perspective view of a bottle, shown our new design;
FIG. 2 is a left side elevation view thereof;
FIG. 3 is a right side elevation view thereof;
FIG. 4 is a rear elevation view thereof;
FIG. 5 is a front elevation view thereof;
FIG. 6 is a top plan view thereof; and,
FIG. 7 is a bottom plan view thereof.

1 Claim, 5 Drawing Sheets

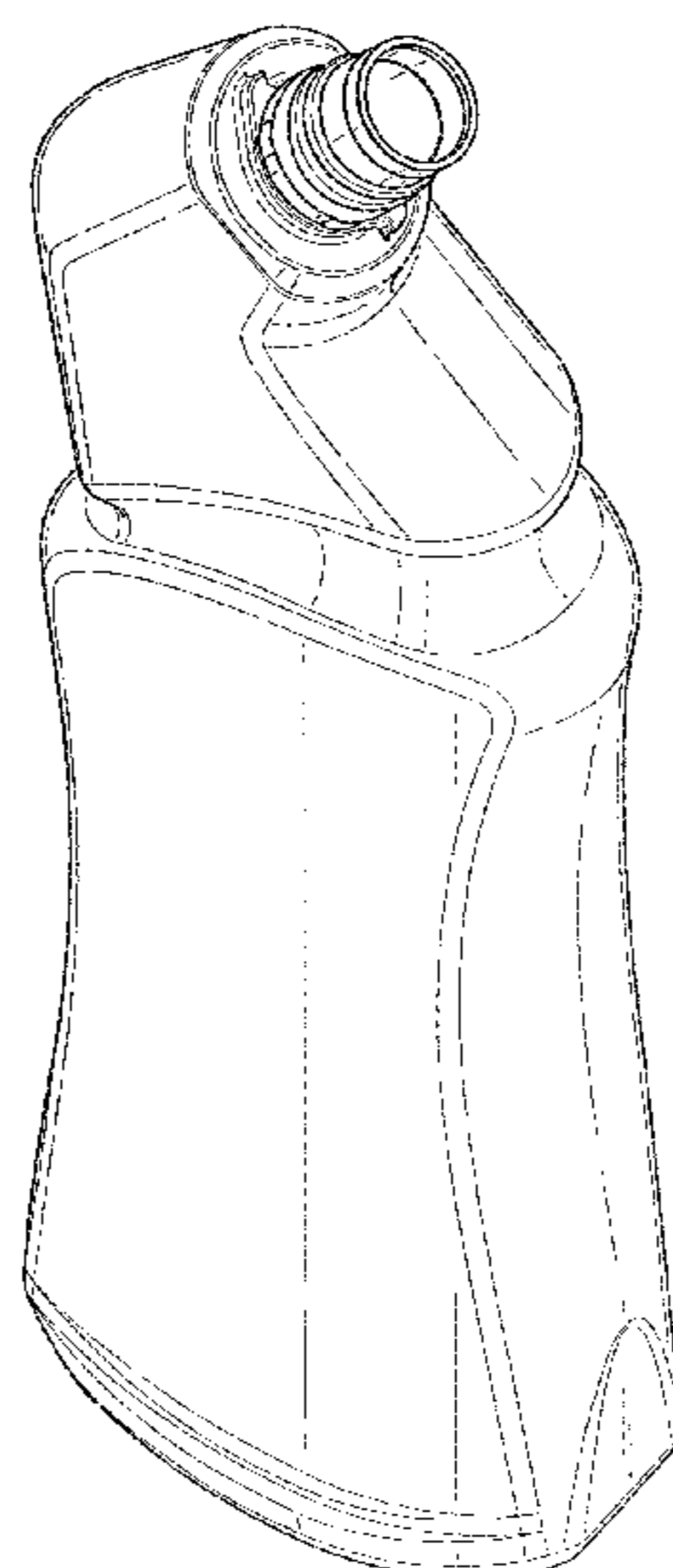

(56)

References Cited

U.S. PATENT DOCUMENTS

2010/0187195 A1* 7/2010 Jamieson B65D 1/023
215/386

OTHER PUBLICATIONS

“500ml Toilet Bowl Cleaner Bottle Mockup.” yellowimages.com.
Date not available. Accessed Apr. 26, 2017. Available online at
URL: <<https://yellowimages.com/stock/500ml-toilet-bowl-cleaner-bottle-mockup/>>.*

* cited by examiner

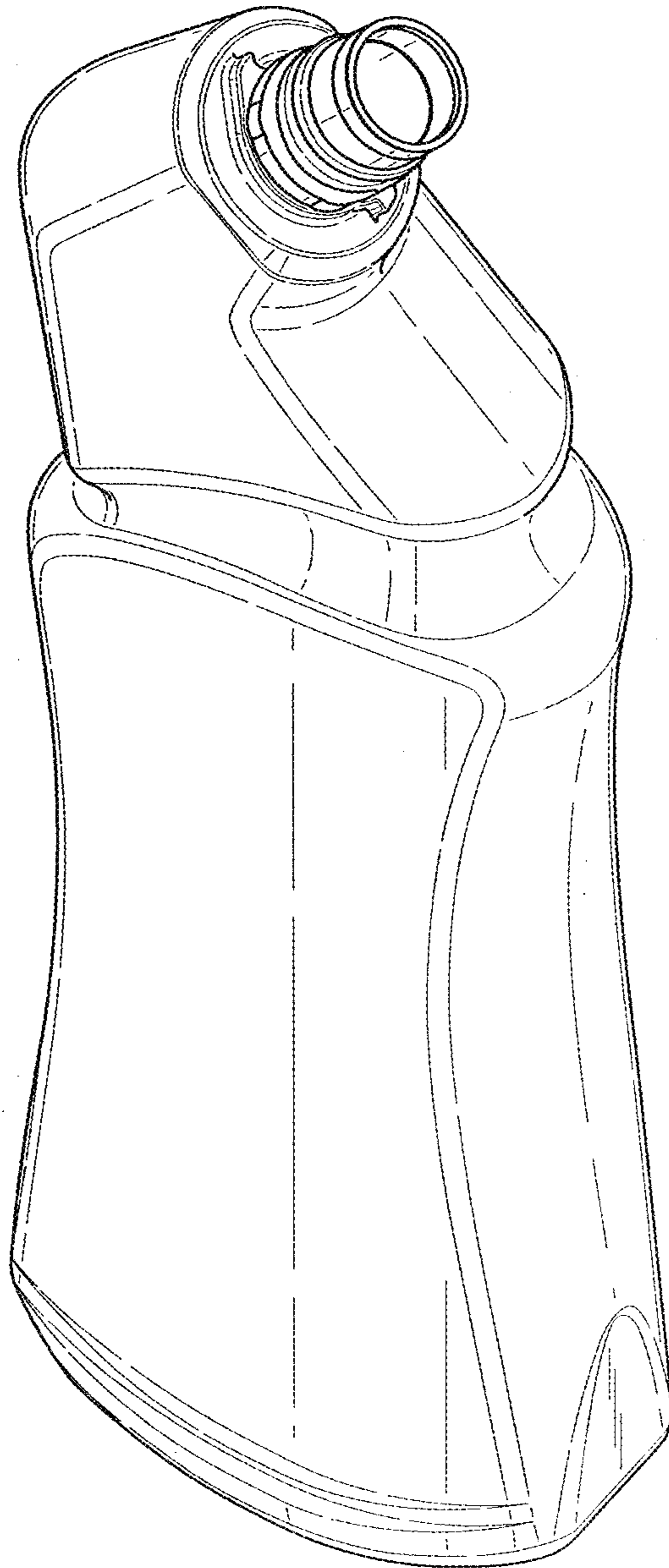

Fig. 1

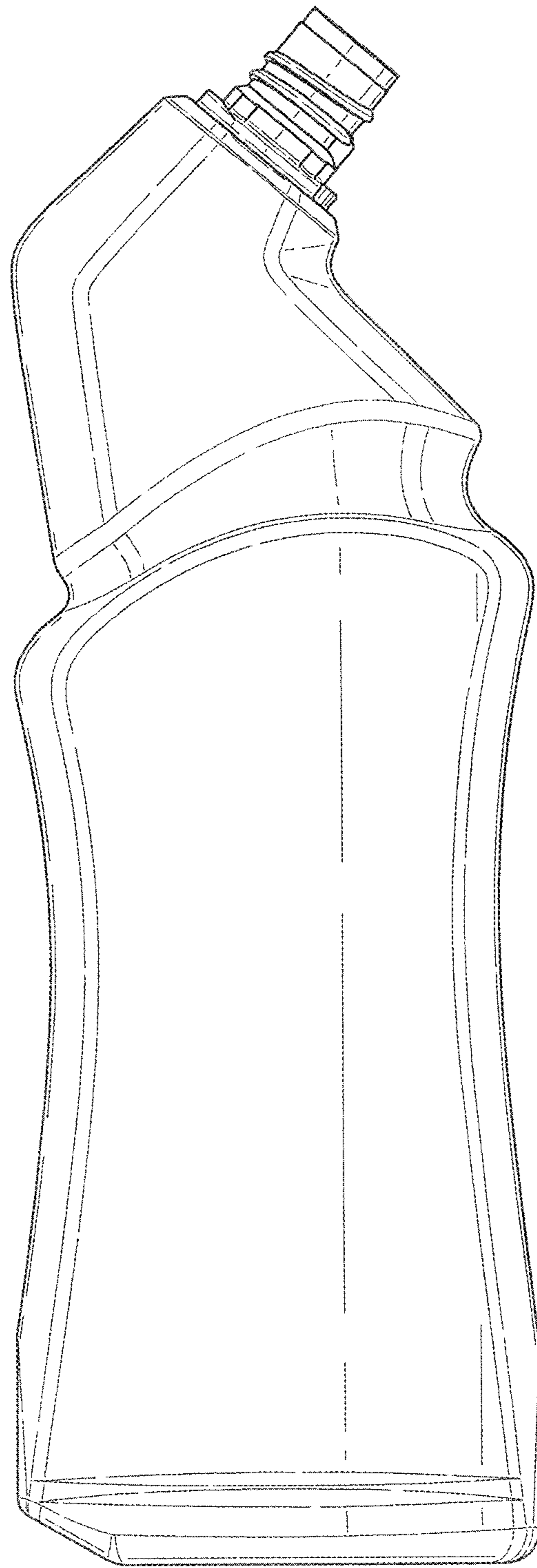

Fig. 2

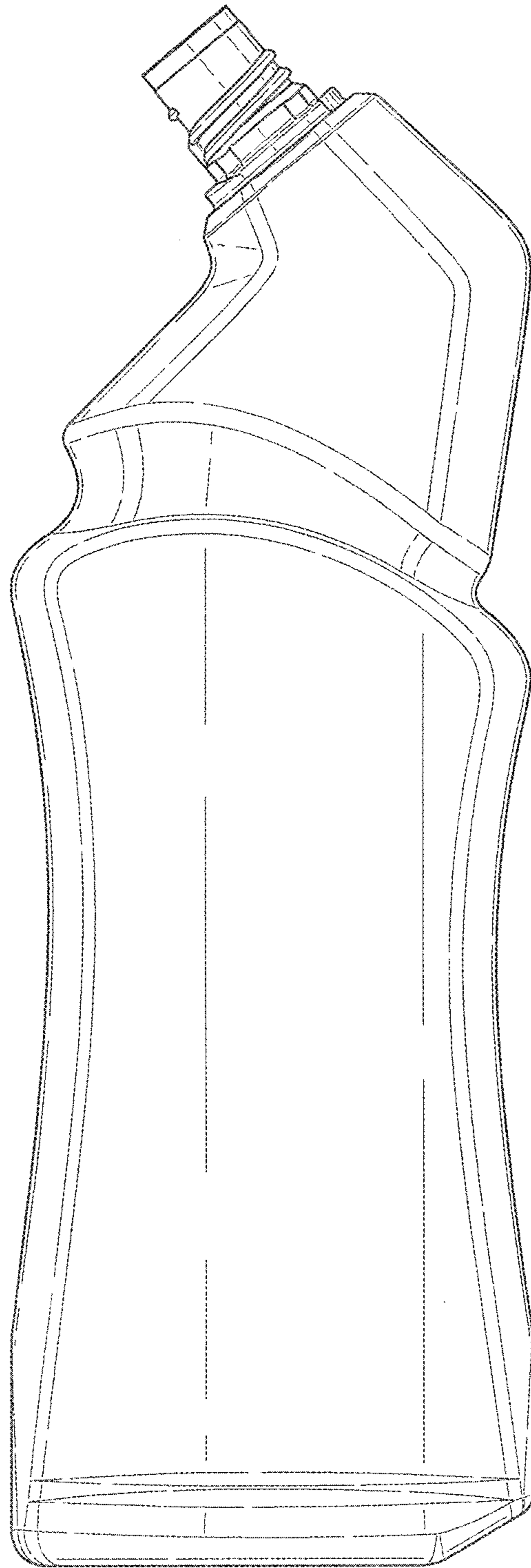

Fig. 3

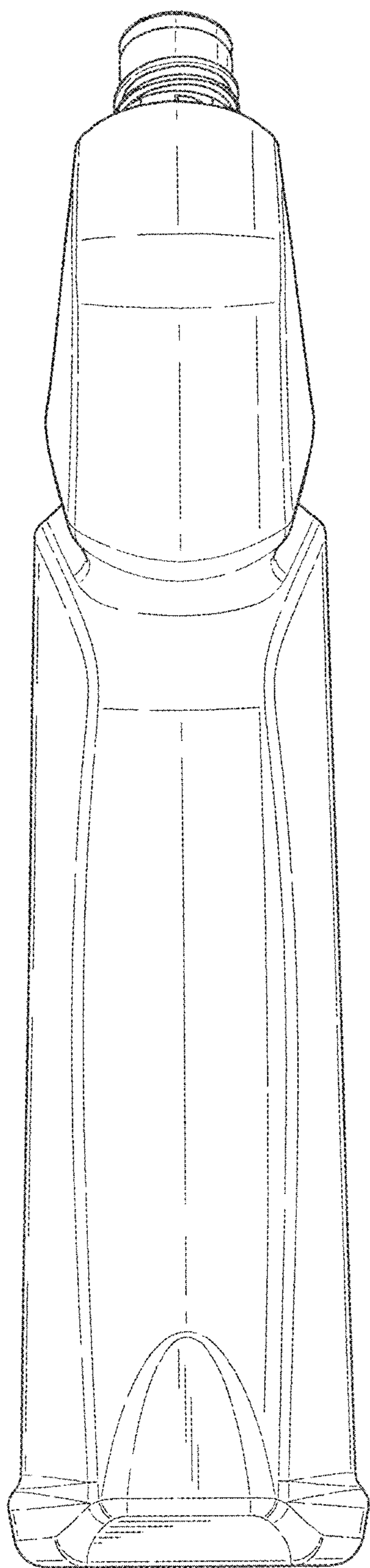

Fig. 4

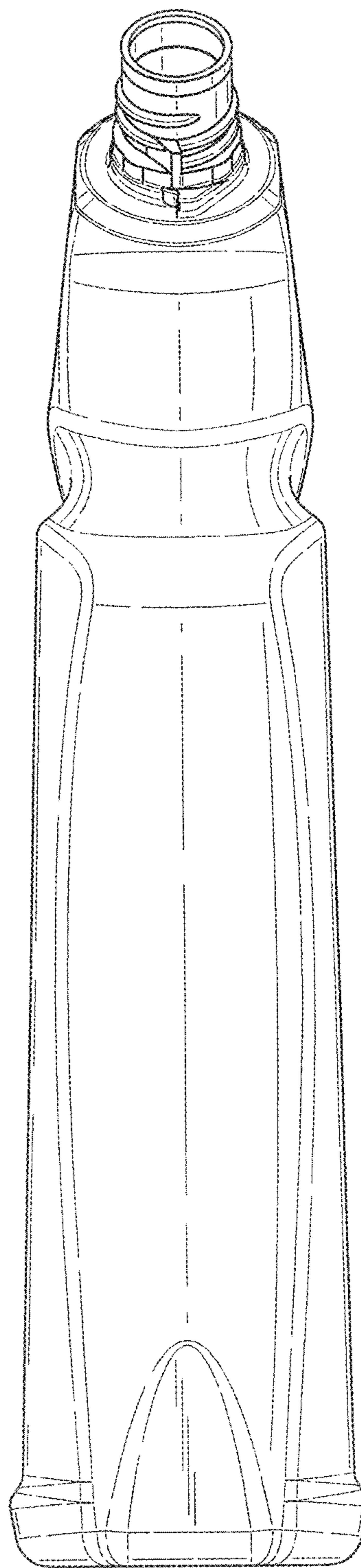

Fig. 5

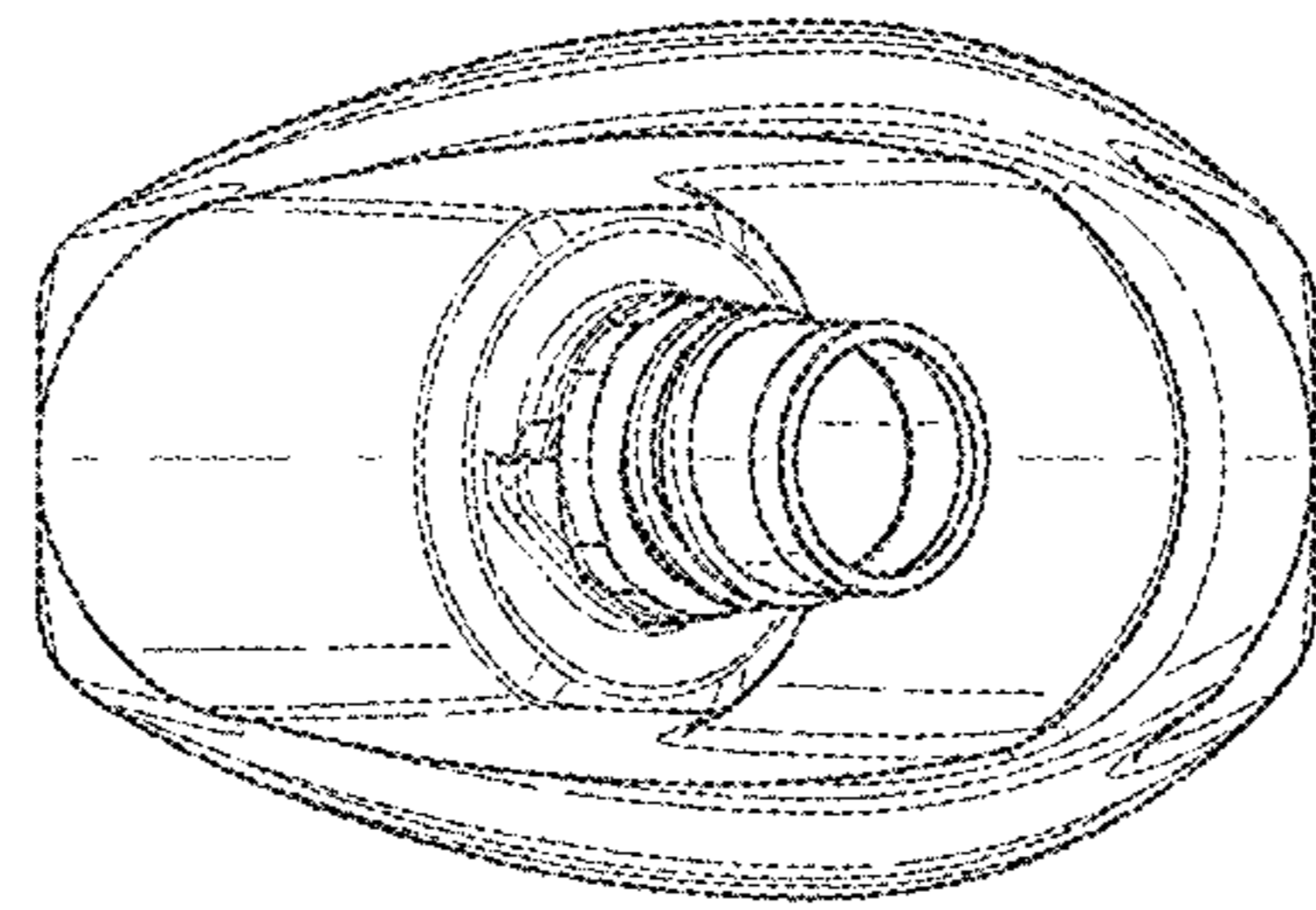

Fig. 6

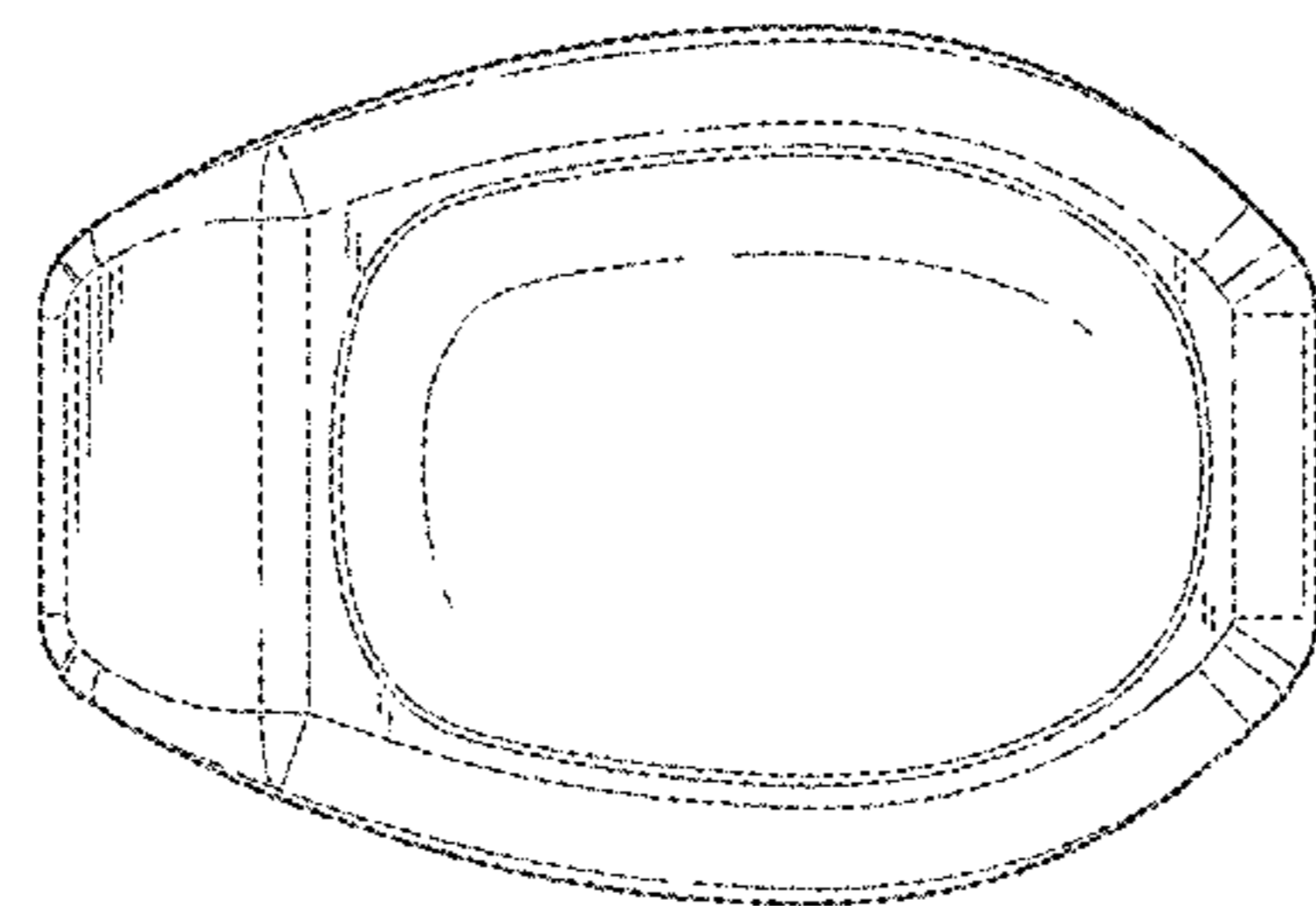

Fig. 7