



US00D790942S

(12) **United States Design Patent**  
**Turner**

(10) **Patent No.:** **US D790,942 S**  
(45) **Date of Patent:** **\*\* Jul. 4, 2017**

- (54) **HOLE SAW**
- (71) Applicant: **Mark Turner**, Alrington, TX (US)
- (72) Inventor: **Mark Turner**, Alrington, TX (US)
- (\*\*) Term: **15 Years**
- (21) Appl. No.: **29/557,083**
- (22) Filed: **Mar. 4, 2016**
- (51) **LOC (10) Cl.** ..... **08-05**
- (52) **U.S. Cl.**  
USPC ..... **D8/70; D8/61**
- (58) **Field of Classification Search**  
USPC ..... D8/61, 67, 70, 107, 64; 409/182, 180,  
409/134, 132, 131; 144/48.6, 252.1,  
144/154.5, 136.95, 153; 279/48;  
D15/138; D10/64  
CPC .. B23D 49/00; B26D 1/00; B27C 5/00; B26F  
1/38; B25F 1/006  
See application file for complete search history.

- 3,745,664 A \* 7/1973 Altseimer ..... H02G 3/14  
220/3.4
- D264,548 S \* 5/1982 Krosunger ..... D8/70
- 4,766,711 A \* 8/1988 Bermingham ..... E04C 1/40  
52/404.1
- D308,326 S \* 6/1990 Makowsky ..... D15/133
- RE33,305 E \* 8/1990 Thayer ..... H02G 3/123  
174/541
- D337,502 S \* 7/1993 Witt ..... D8/70
- D437,757 S \* 2/2001 Thomson ..... D8/61
- D577,975 S \* 10/2008 Bahler ..... D8/70
- D590,684 S \* 4/2009 Budzik ..... D15/138
- 7,845,089 B1 \* 12/2010 Lavallo ..... H02G 1/00  
33/528
- D750,461 S \* 3/2016 McRoberts ..... D8/70

\* cited by examiner

*Primary Examiner* — Austin Murphy  
(74) *Attorney, Agent, or Firm* — James L. Baudino

(57) **CLAIM**

The ornamental design for a hole saw, as shown.

**DESCRIPTION**

FIG. 1 is a top perspective view of a hole saw showing the new design;  
FIG. 2 is a front elevation view thereof;  
FIG. 3 is a rear elevation view thereof;  
FIG. 4 is a right side elevation view thereof;  
FIG. 5 is a left side elevation view thereof;  
FIG. 6 is a top plan view thereof; and,  
FIG. 7 is a bottom plan view thereof.

**1 Claim, 6 Drawing Sheets**

(56) **References Cited**  
U.S. PATENT DOCUMENTS

- 1,791,311 A \* 2/1931 Hamblen ..... H02G 3/123  
220/3.6
- 1,963,951 A \* 6/1934 Bowers ..... H02G 3/125  
174/58
- 2,015,339 A \* 9/1935 Ellingham ..... B23B 51/0406  
408/199

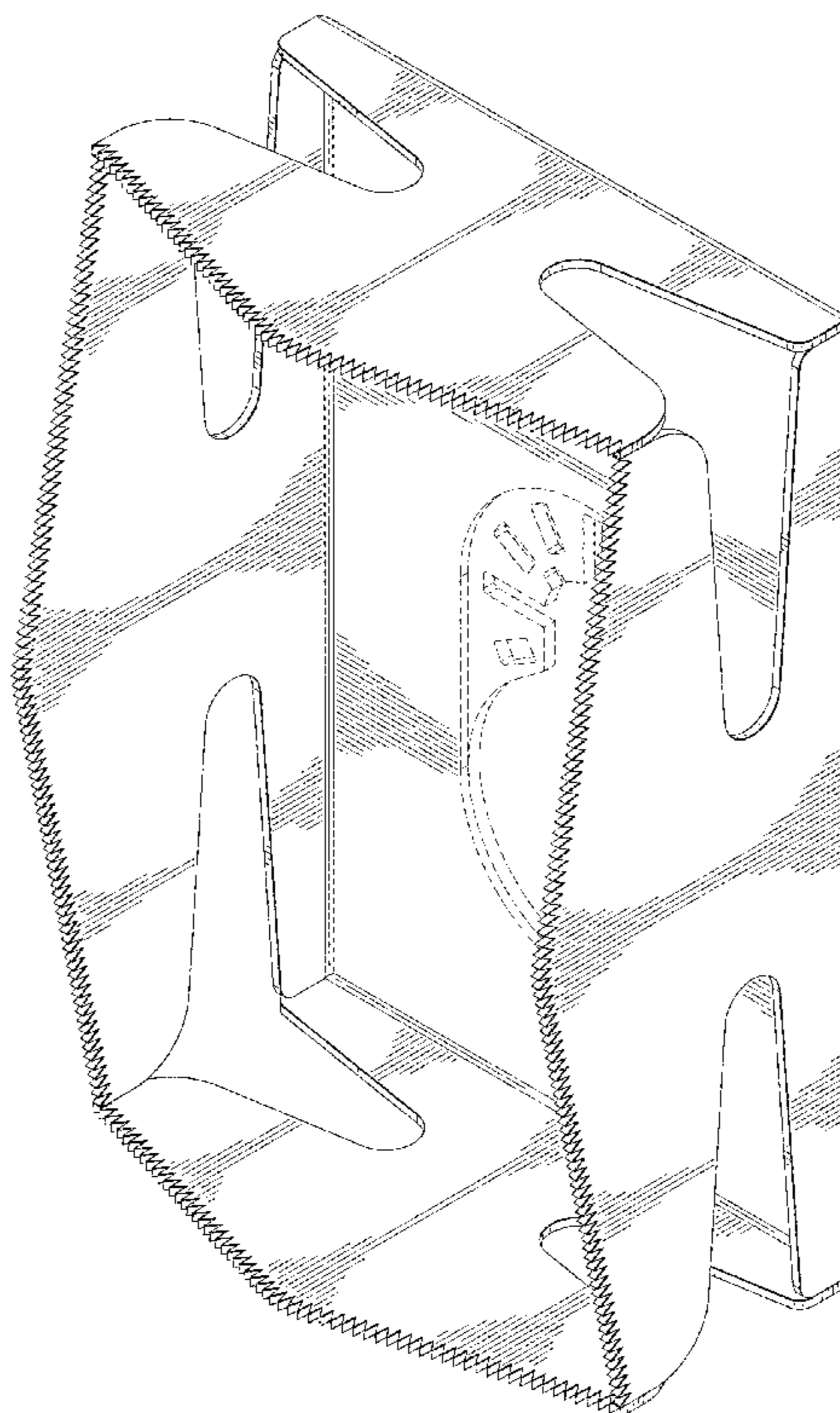

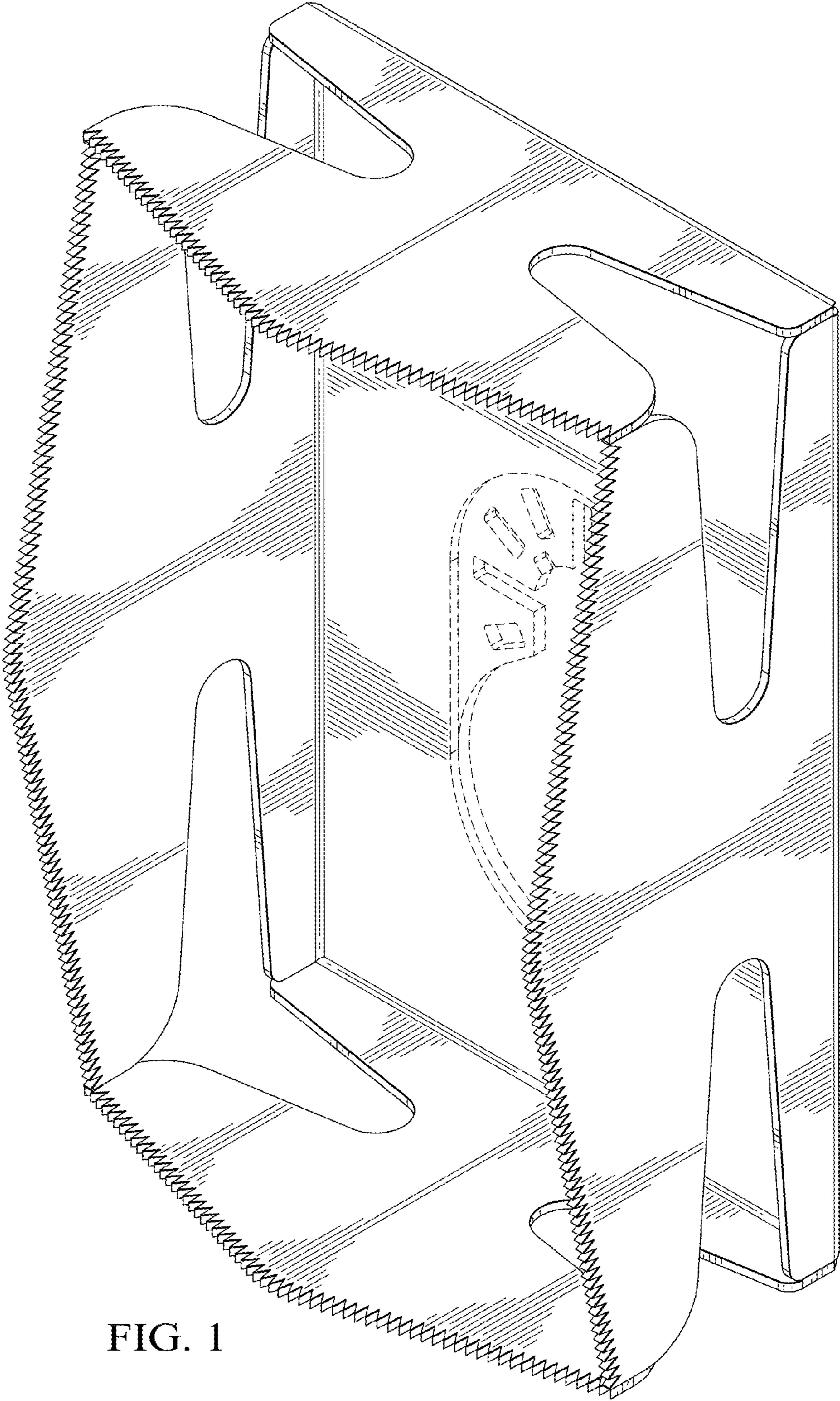

FIG. 1

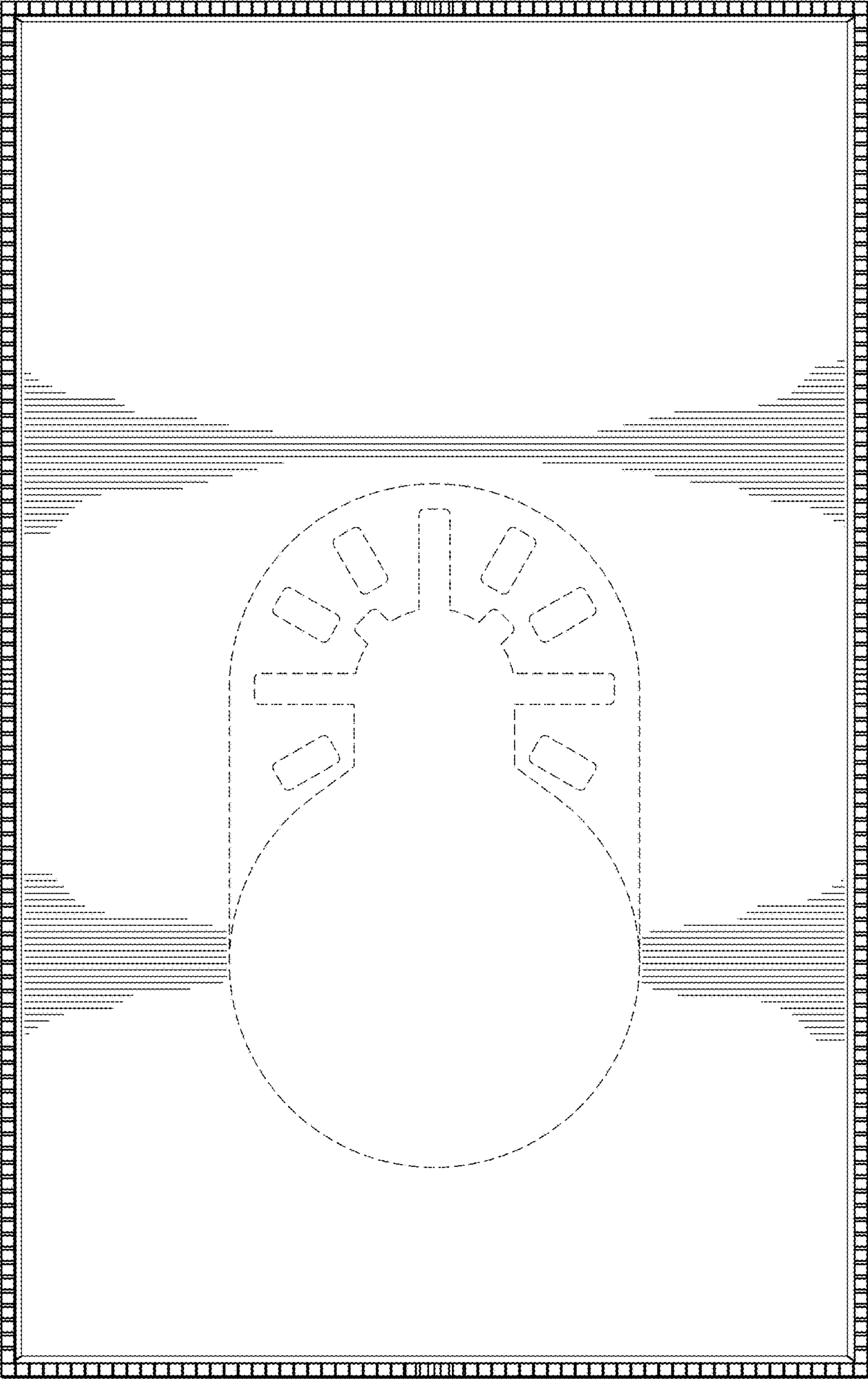

FIG. 2

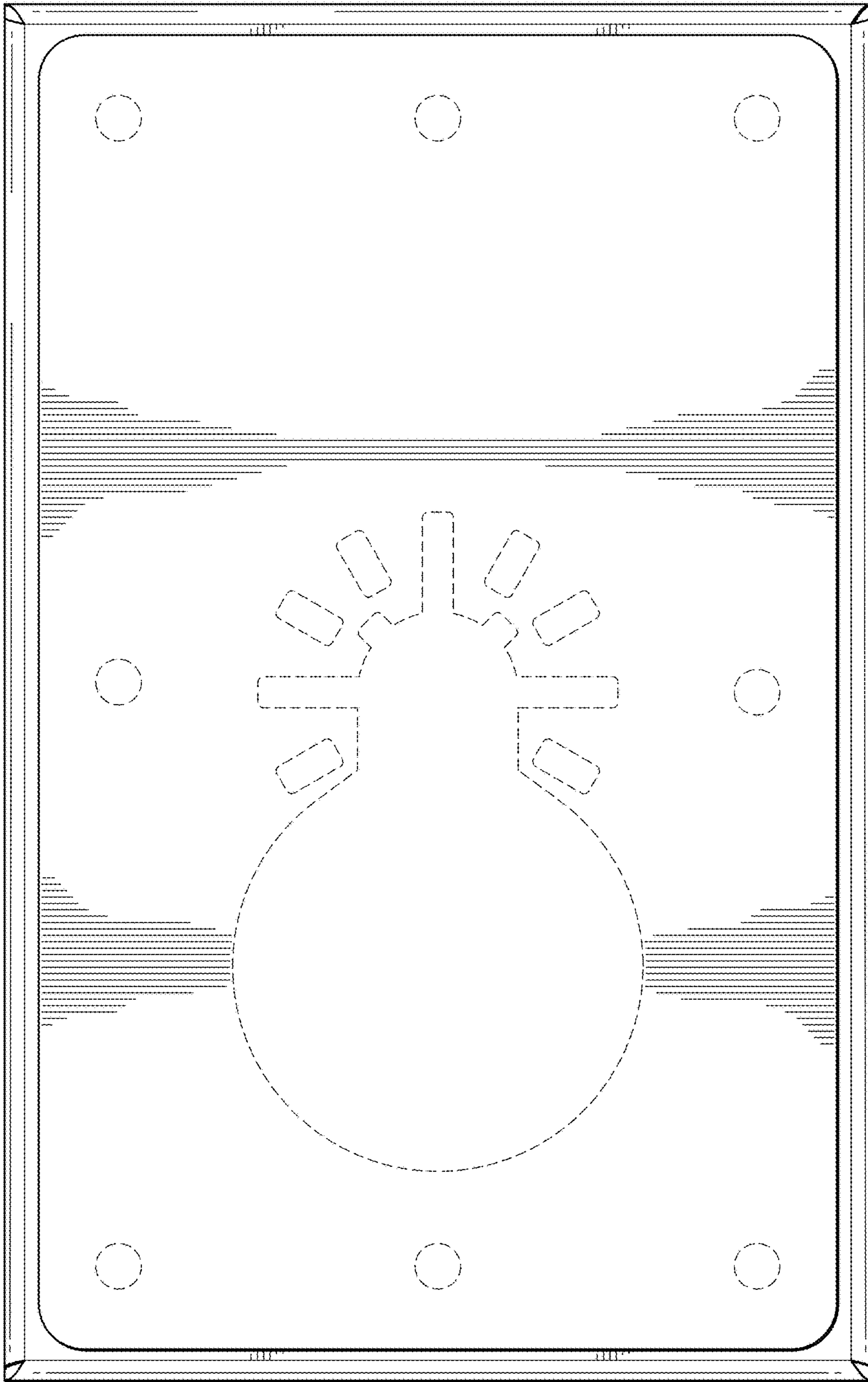

FIG. 3

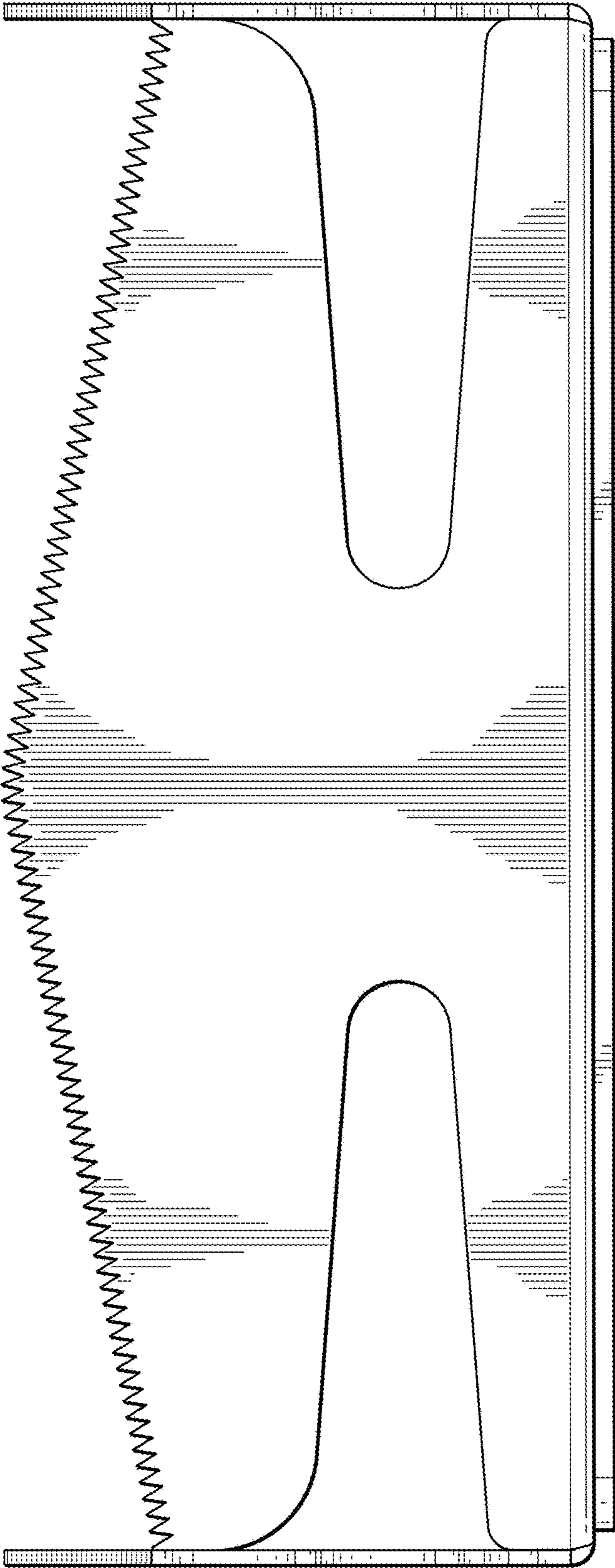

FIG. 4

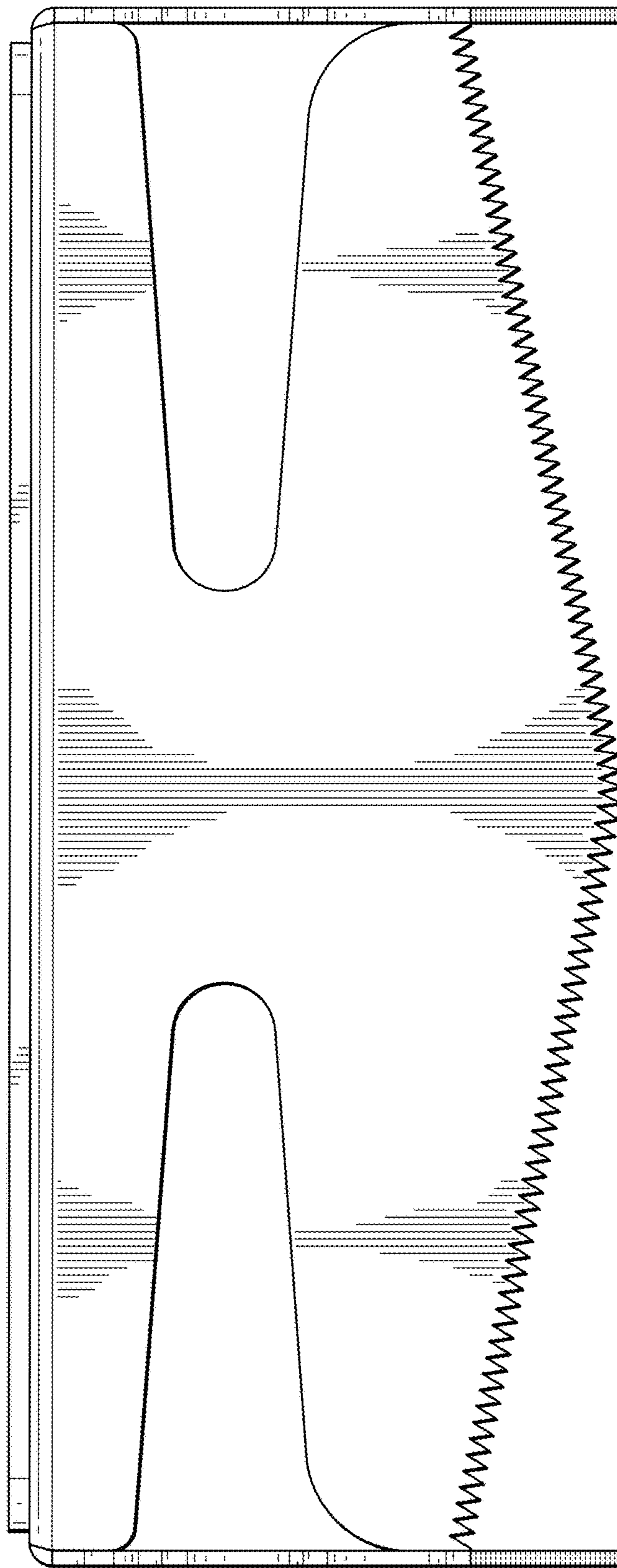

FIG. 5

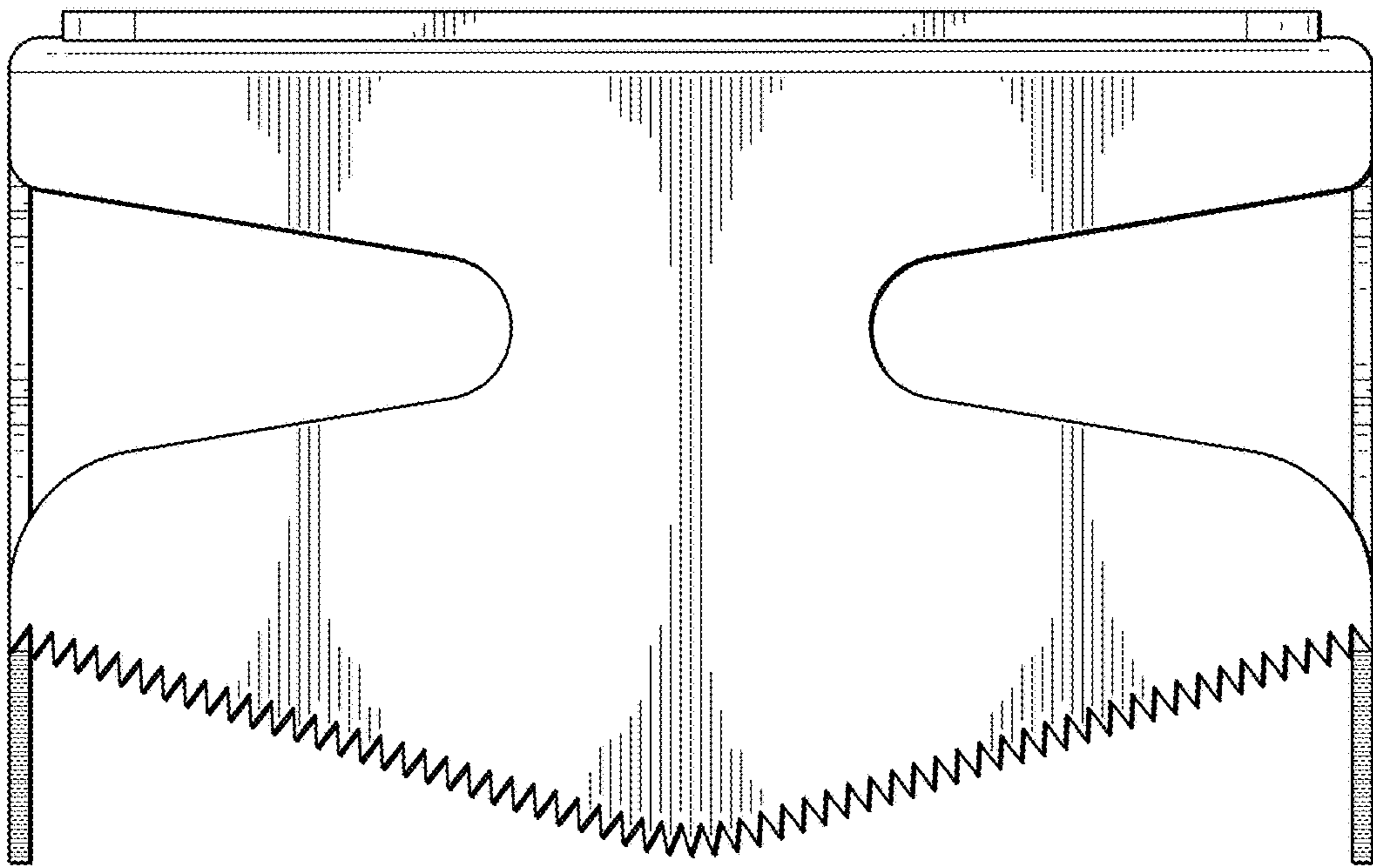

FIG. 6

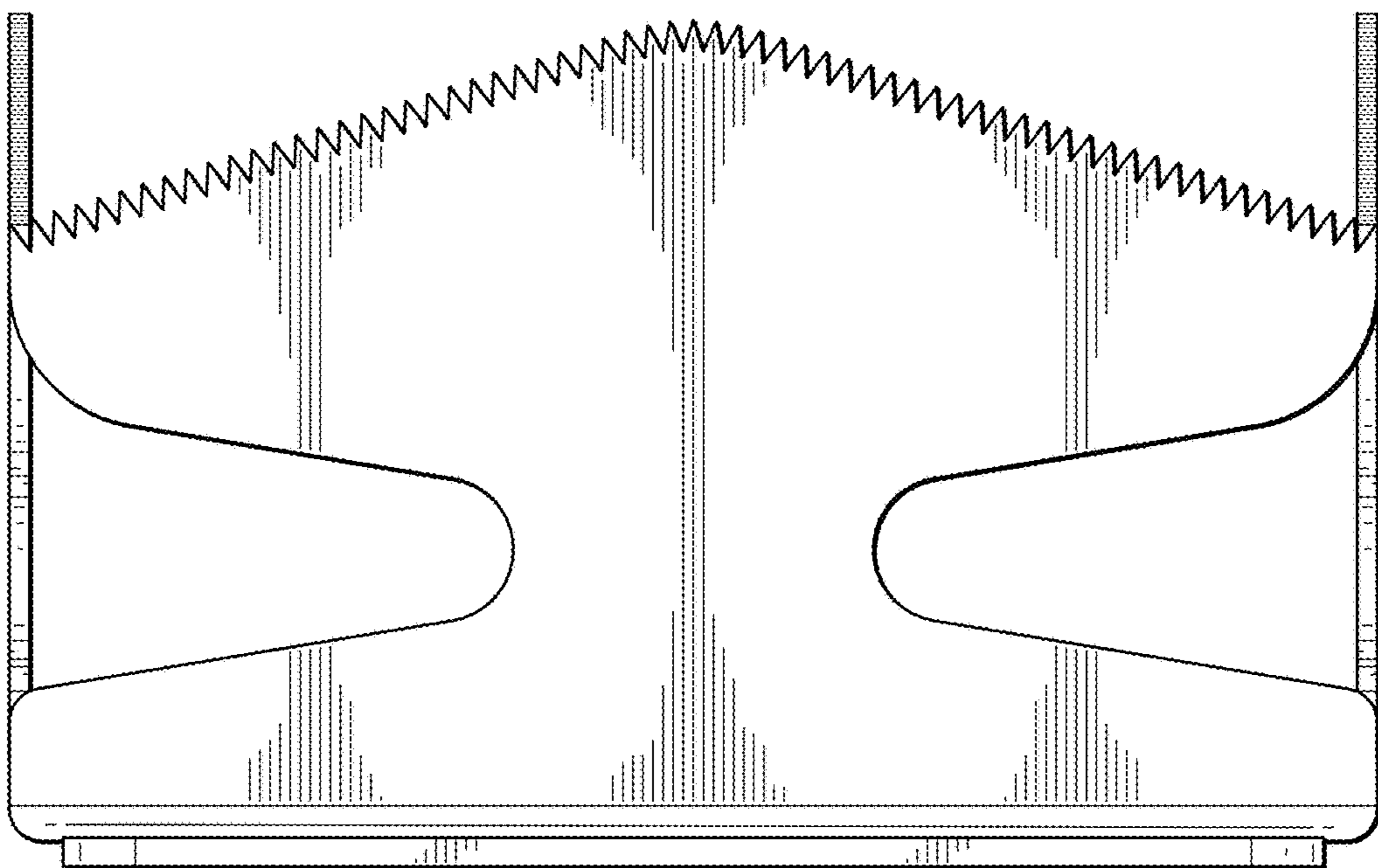

FIG. 7