



US00D790936S

(12) **United States Design Patent** (10) **Patent No.:** **US D790,936 S**
Leys et al. (45) **Date of Patent:** **** Jul. 4, 2017**

(54) **WRENCH**

(71) Applicant: **ENTEGRIS, INC.**, Billerica, MA (US)

(72) Inventors: **John A. Leys**, Chaska, MN (US);
Michael Schleicher, Eden Prairie, MN (US); **Jeffrey J. McKenzie**, Watertown, MN (US)

(73) Assignee: **Entegris, Inc.**, Billerica, MA (US)

(**) Term: **14 Years**

(21) Appl. No.: **29/522,687**

(22) Filed: **Apr. 1, 2015**

(51) **LOC (10) Cl.** **08-05**

(52) **U.S. Cl.**
USPC **D8/21**

(58) **Field of Classification Search**
USPC D8/21-29; 81/177.1, 177.85, 121.1,
81/124.3, 165-170, 110.1, 176.2, 124.6,
81/176.1, 176.15, 177.2; 16/110.1

(Continued)

(56) **References Cited**

U.S. PATENT DOCUMENTS

1,836,716 A 12/1931 Huthsing
2,224,610 A 12/1940 Schellin et al.

(Continued)

FOREIGN PATENT DOCUMENTS

DE 198 35 832 A1 2/2000
JP 2000-354973 A 12/2000

(Continued)

OTHER PUBLICATIONS

John A. Leys et al., High Torque Polymer Fittings, U.S. Appl. No. 62/042,120, filed Aug. 26, 2014.

(Continued)

Primary Examiner — Randall Gholson

(74) *Attorney, Agent, or Firm* — Entegris, Inc. Legal Dept.; Catherine D. Gates

(57) **CLAIM**

The ornamental design for a wrench, as shown and described.

DESCRIPTION

FIG. 1 is a perspective view of a wrench according to an embodiment of the invention. The view from the opposite side being a mirror image thereof.

FIG. 2 is a right-side view of the wrench depicted in FIG. 1.

FIG. 3 is a left-side view of the wrench depicted in FIG. 1.

FIG. 4 is a top view of the wrench depicted in FIG. 1.

FIG. 5 is a bottom view of the wrench depicted in FIG. 1.

FIG. 6 is a front view of the wrench depicted in FIG. 1.

FIG. 7 is a rear view of the wrench depicted in FIG. 1.

FIG. 8 is a perspective view of a wrench according to another embodiment of the invention. The view from the opposite side being a mirror image thereof.

FIG. 9 is a right-side view of the wrench depicted in FIG. 8.

FIG. 10 is a left-side view of the wrench depicted in FIG. 8.

FIG. 11 is a top view of the wrench depicted in FIG. 8.

FIG. 12 is a bottom view of the wrench depicted in FIG. 8.

FIG. 13 is a front view of the wrench depicted in FIG. 8; and,

FIG. 14 is a rear view of the wrench depicted in FIG. 8.

The portions shown in dashed lines, including the inside surfaces of the heads on either end of the wrench, are not part of the claimed design.

The claim extends to, but does not include, the broken lines.

1 Claim, 12 Drawing Sheets

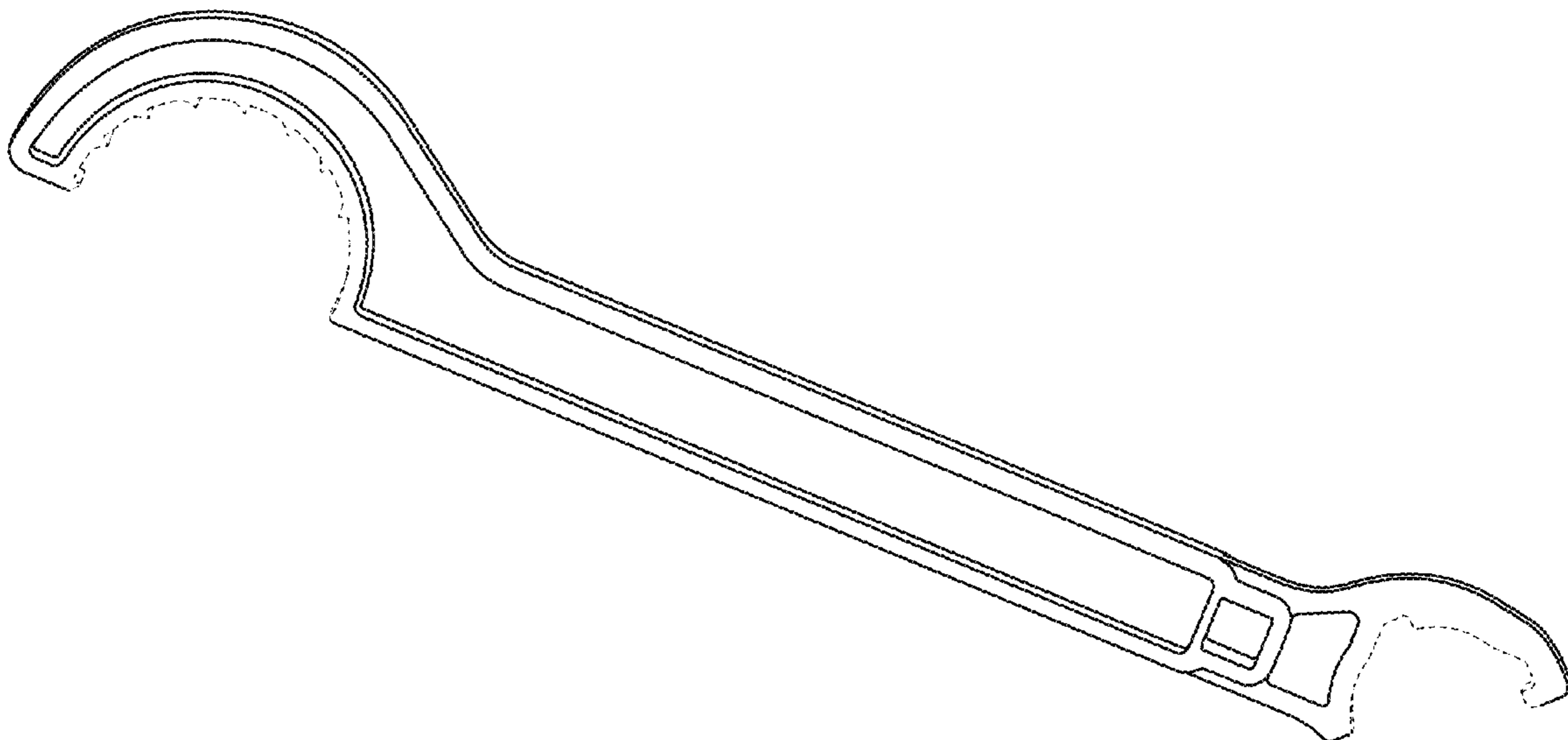

(58) **Field of Classification Search**
 CPC B25B 1/00; B25B 19/00; B25B 27/00
 See application file for complete search history.

D717,619	S *	11/2014	Kundracik	D8/23
2004/0144220	A1	7/2004	Stoick et al.	
2005/0077730	A1	4/2005	Thut	
2005/0150332	A1	7/2005	Russell	
2012/0325058	A1	12/2012	Stricker	
2014/0210205	A1	7/2014	Yamada et al.	

(56) **References Cited**

U.S. PATENT DOCUMENTS

2,334,069	A	11/1943	Collings et al.	
4,738,169	A	4/1988	Wyka	
D329,788	S *	9/1992	Andrew	D8/17
5,428,853	A *	7/1995	Menke	A62B 3/005 7/138
D379,053	S *	5/1997	Howard	D8/21
D399,715	S *	10/1998	Budd, Sr.	D8/17
D422,466	S *	4/2000	Kovach	D8/17
D461,107	S	8/2002	Pitt	
6,745,648	B2	6/2004	Stier	
D596,011	S *	7/2009	Almayda	D8/105
7,648,178	B1	1/2010	Andros	
D662,383	S *	6/2012	Cizek	D8/40
D675,076	S *	1/2013	Oachs	D8/17

FOREIGN PATENT DOCUMENTS

JP	2006-017135	A	1/2006
TW	201002478	A	1/2010

OTHER PUBLICATIONS

John A. Leys et al., High Torque Polymer Fittings, U.S. Appl. No. 62/098,116, filed Dec. 30, 2014.
 JME Ellsworth [online] United Fire Safety Spanner Wrenches Photo, Accessed on Jan. 12, 2015, Retrieved from the Internet: <http://www.jmesales.com/product/united-fire-safety-spanner-wrenches,10249,4741.htm>.

* cited by examiner

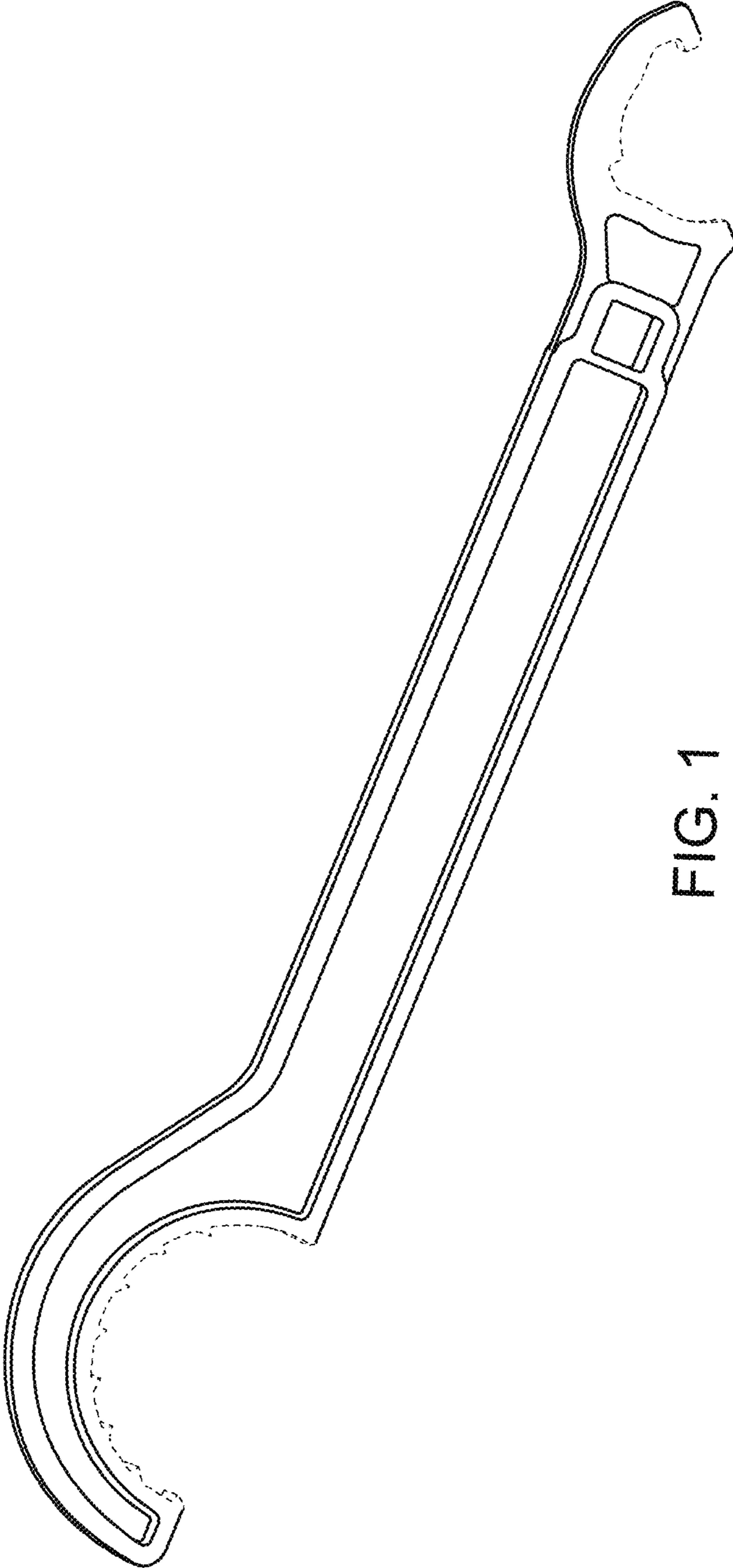

FIG. 1

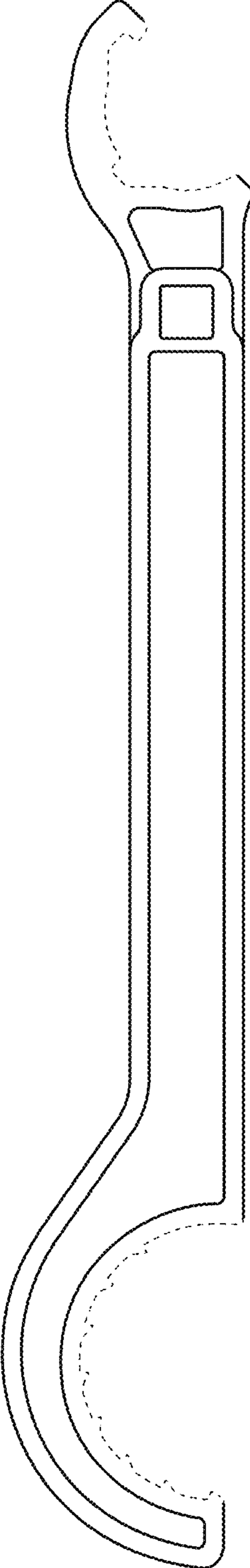

FIG. 2

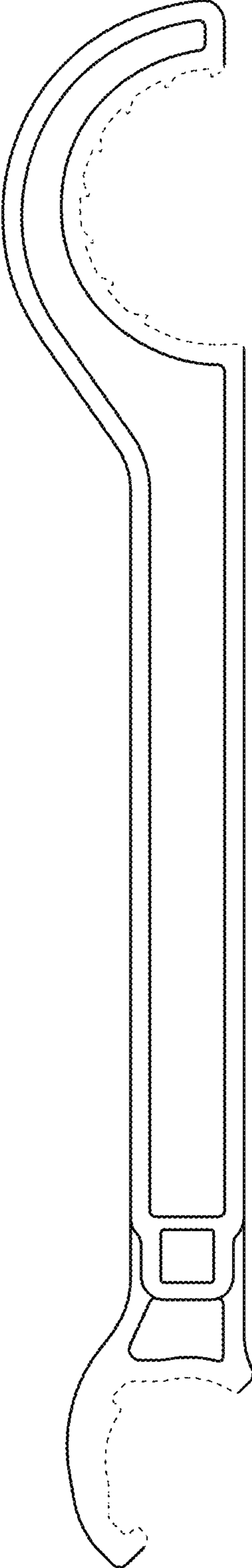

FIG. 3

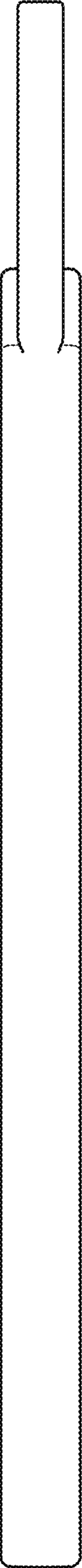

FIG. 4

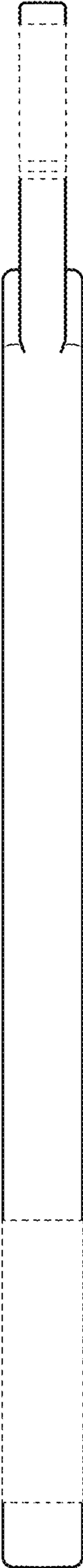

FIG. 5

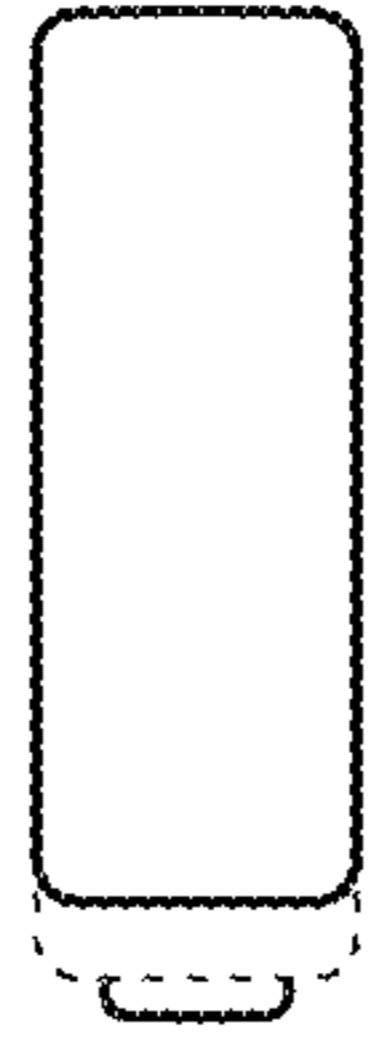

FIG. 6

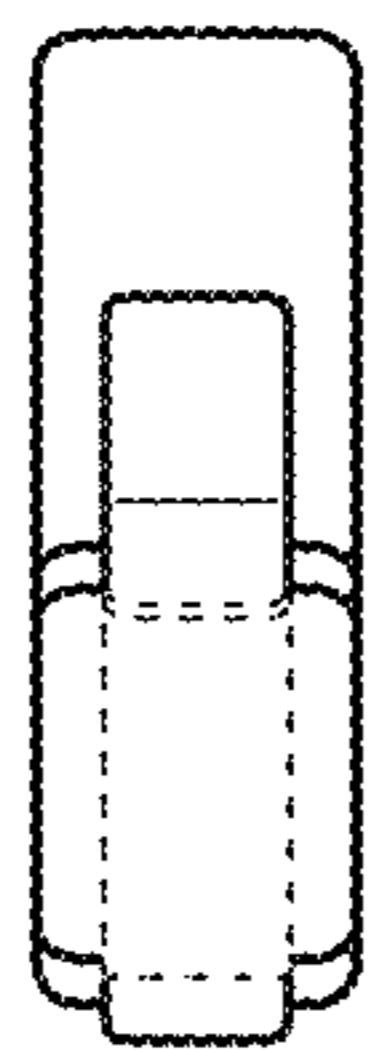

FIG. 7

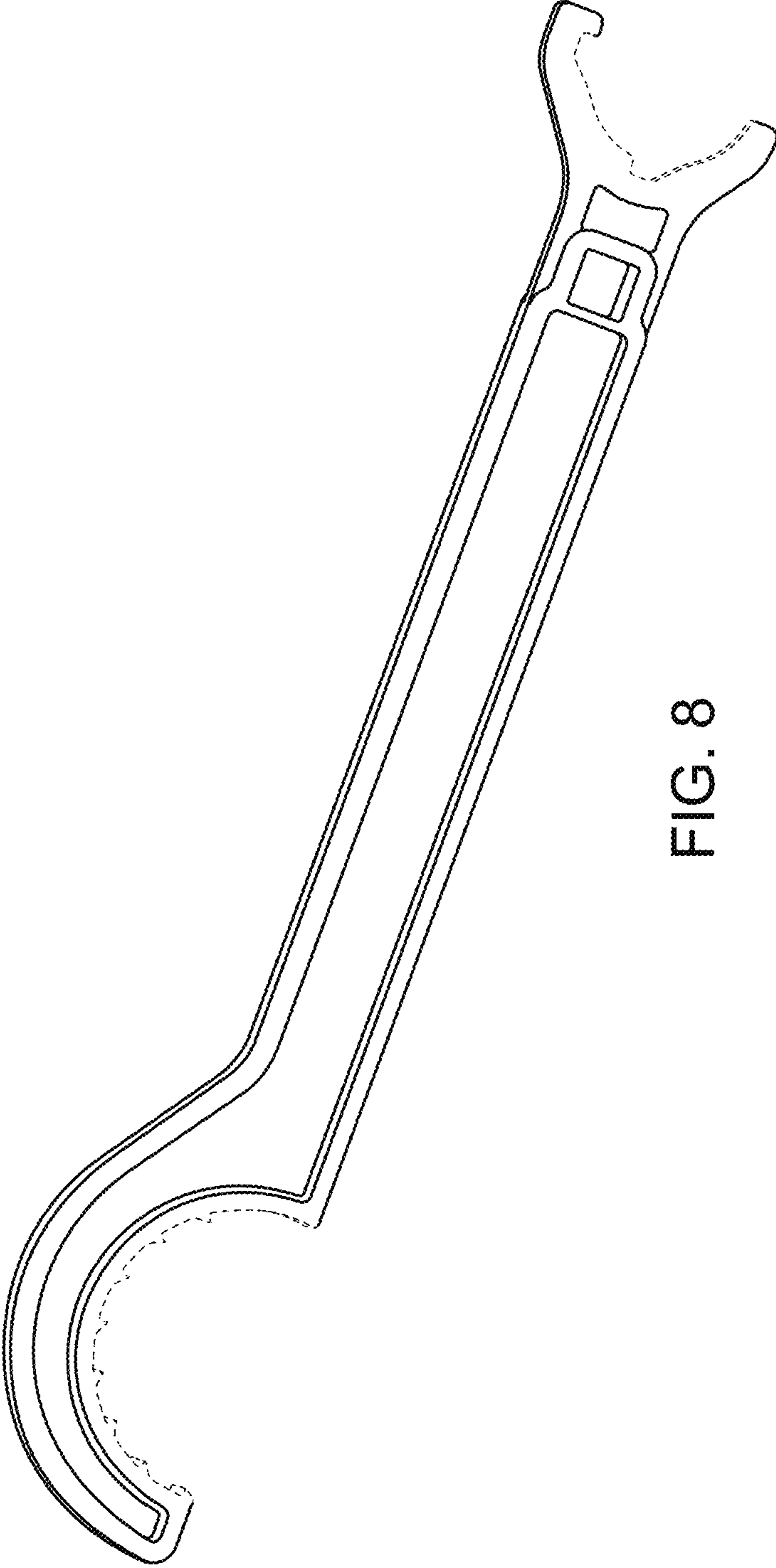

FIG. 8

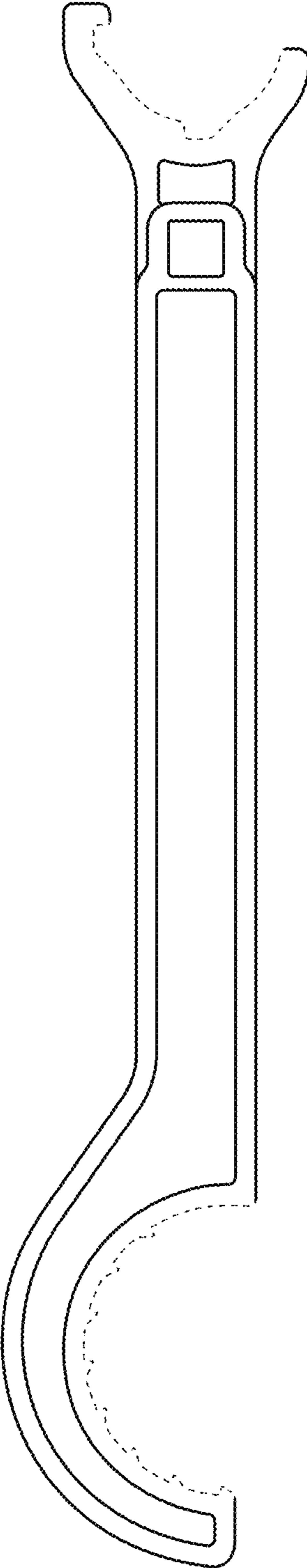

FIG. 9

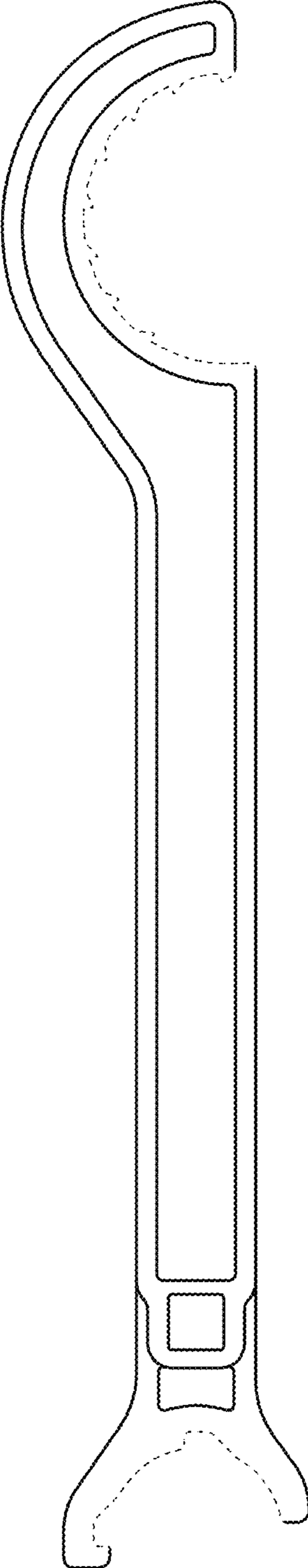

FIG. 10

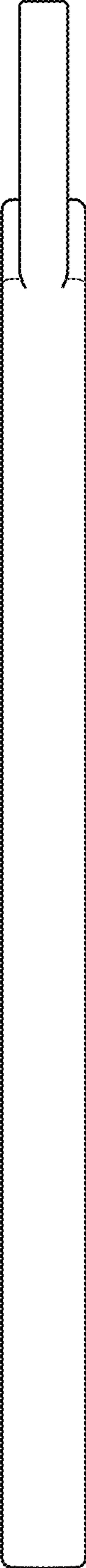

FIG. 11



FIG. 12

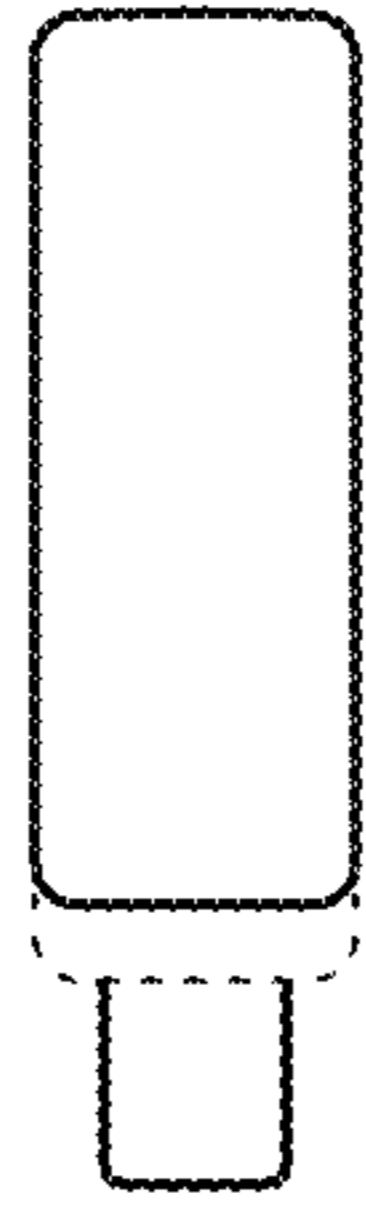

FIG. 13

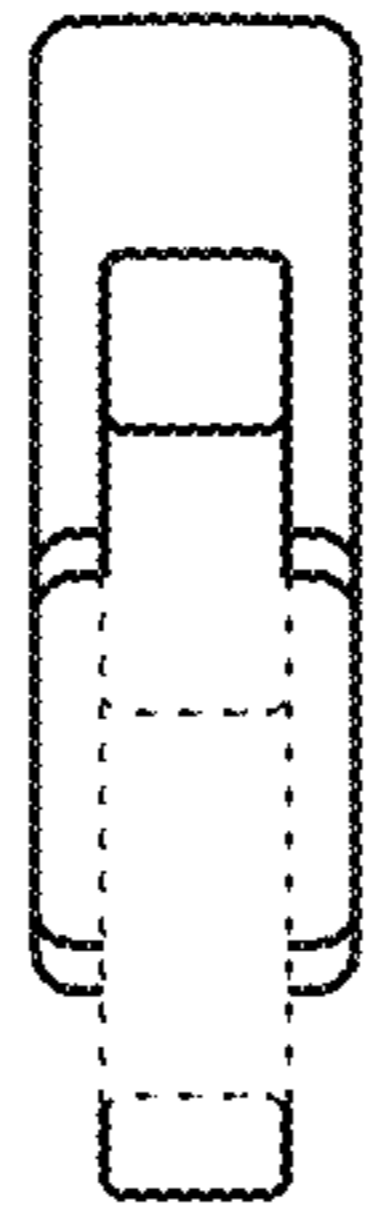

FIG. 14