



US00D790922S

(12) **United States Design Patent** (10) **Patent No.:** **US D790,922 S**
Do (45) **Date of Patent:** **** Jul. 4, 2017**

(54) **BOTTLE**
(71) Applicant: **Level Terrain, LLC**, Broomfield, CO (US)
(72) Inventor: **Warren Do**, Boulder, CO (US)
(73) Assignee: **Level Terrain LLC**, Broomfield, CO (US)
(**) Term: **15 Years**
(21) Appl. No.: **29/563,978**
(22) Filed: **May 10, 2016**
(51) **LOC (10) Cl.** **07-01**
(52) **U.S. Cl.**
USPC **D7/511**; D7/510
(58) **Field of Classification Search**
USPC D7/509-511; D9/447; D24/194, 196.1
CPC A47G 19/2266; B65D 43/02; B65D 41/04;
B65D 41/0414
See application file for complete search history.

D602,365 S * 10/2009 Willows D9/522
D635,864 S * 4/2011 Lee D9/521
D691,479 S * 10/2013 Bea D9/447
D736,562 S * 8/2015 Green D7/510
D756,792 S * 5/2016 Genaw, Jr. D9/522

* cited by examiner

Primary Examiner — Daniel Bui
Assistant Examiner — Andrew Kerr
(74) *Attorney, Agent, or Firm* — Sheridan Ross P.C.

(57) **CLAIM**
The ornamental design for a bottle, as shown and described.

DESCRIPTION

FIG. 1 is a perspective view of a bottle showing my new design;
FIG. 2 is a front elevation view thereof;
FIG. 3 is a rear elevation view thereof;
FIG. 4 is a right elevation view thereof;
FIG. 5 is a left elevation view thereof;
FIG. 6 is a top plan view thereof;
FIG. 7 is a bottom plan view thereof;
FIG. 8 is a perspective view of an alternative embodiment;
FIG. 9 is a front elevation view thereof;
FIG. 10 is a rear elevation view thereof;
FIG. 11 is a right elevation view thereof;
FIG. 12 is a left elevation view thereof;
FIG. 13 is a top plan view thereof; and,
FIG. 14 is a bottom plan view thereof.

(56) **References Cited**

U.S. PATENT DOCUMENTS

D432,918 S * 10/2000 Aftoora D7/590
D543,851 S * 6/2007 Franic D9/522

1 Claim, 9 Drawing Sheets

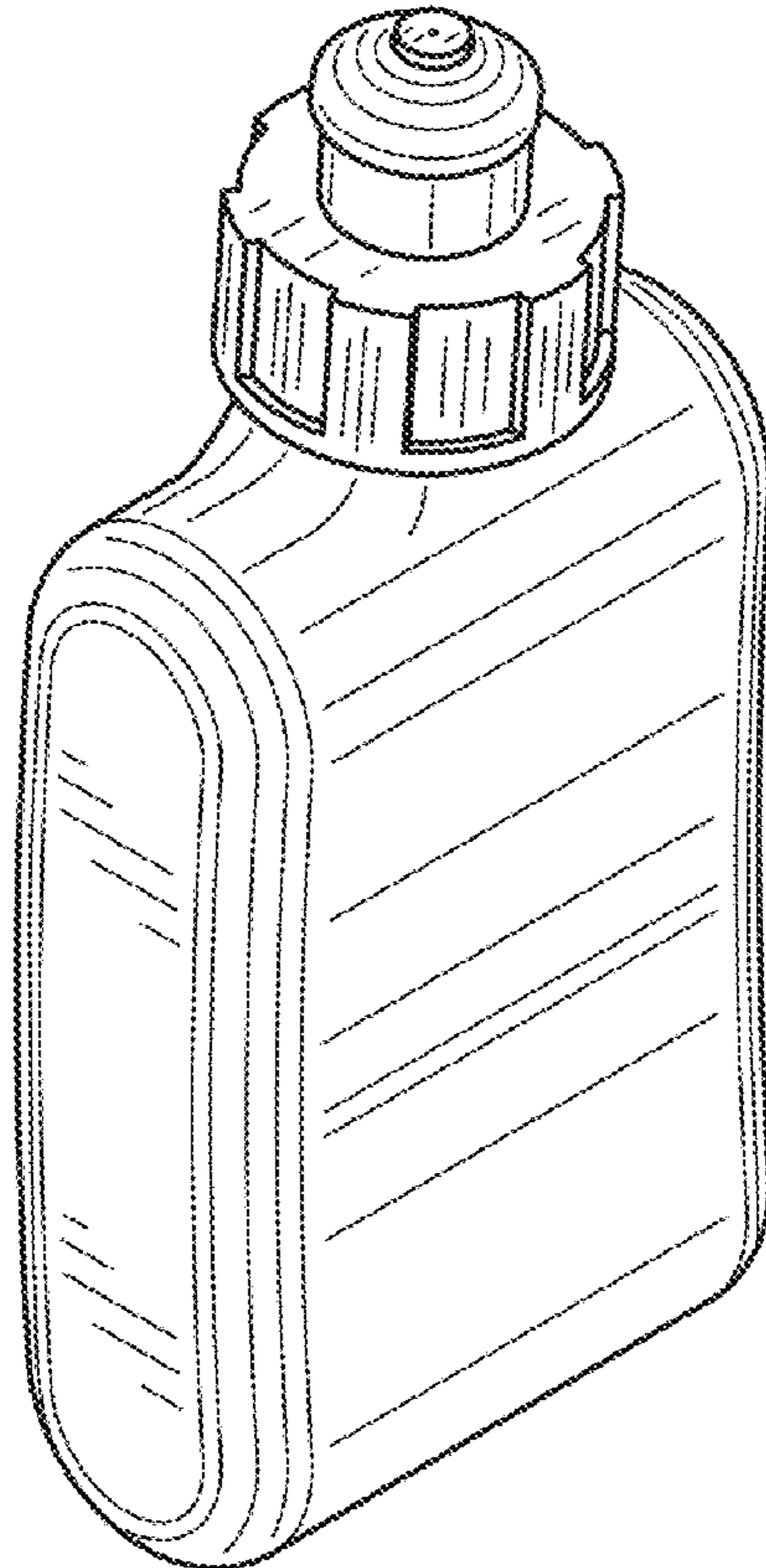

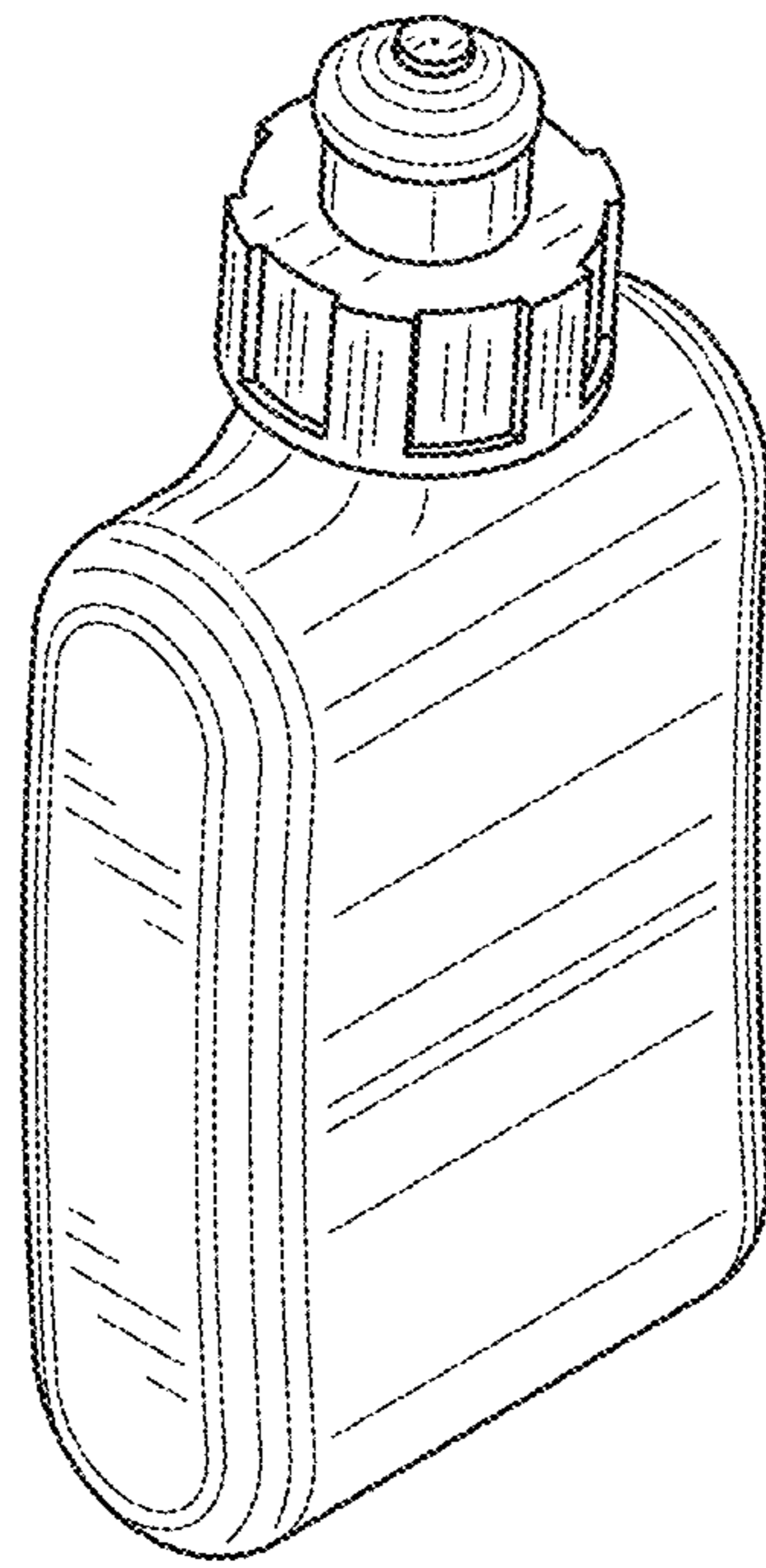

FIG. 1

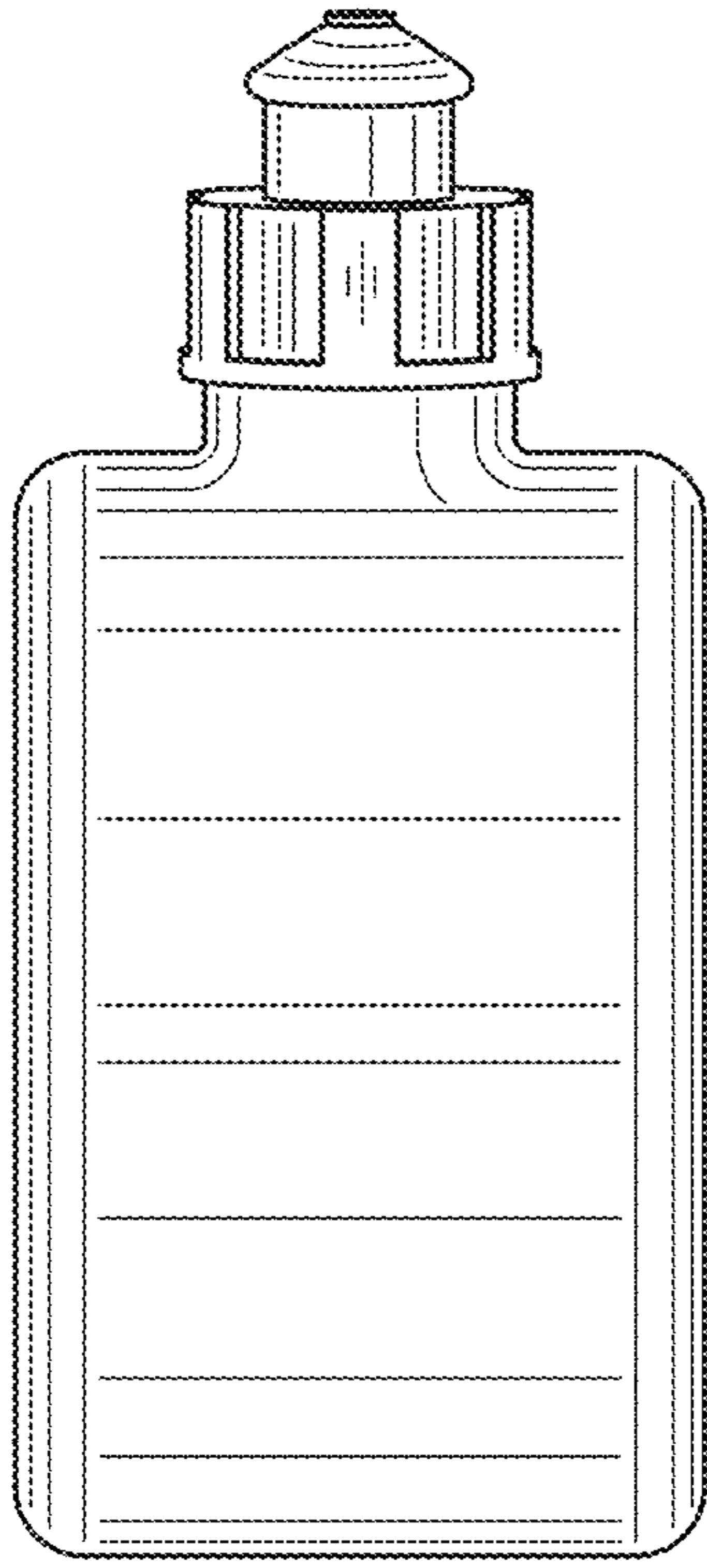

FIG. 2

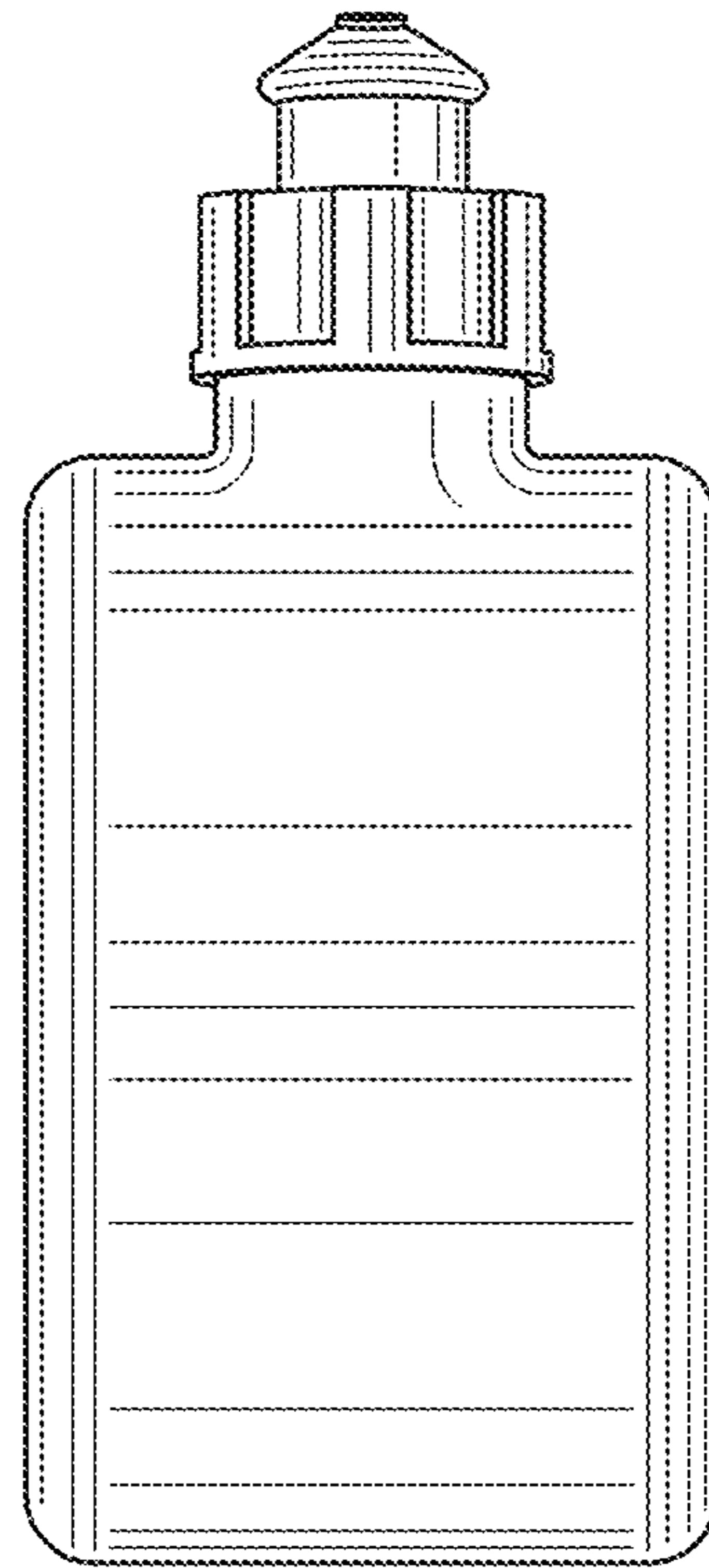

FIG. 3

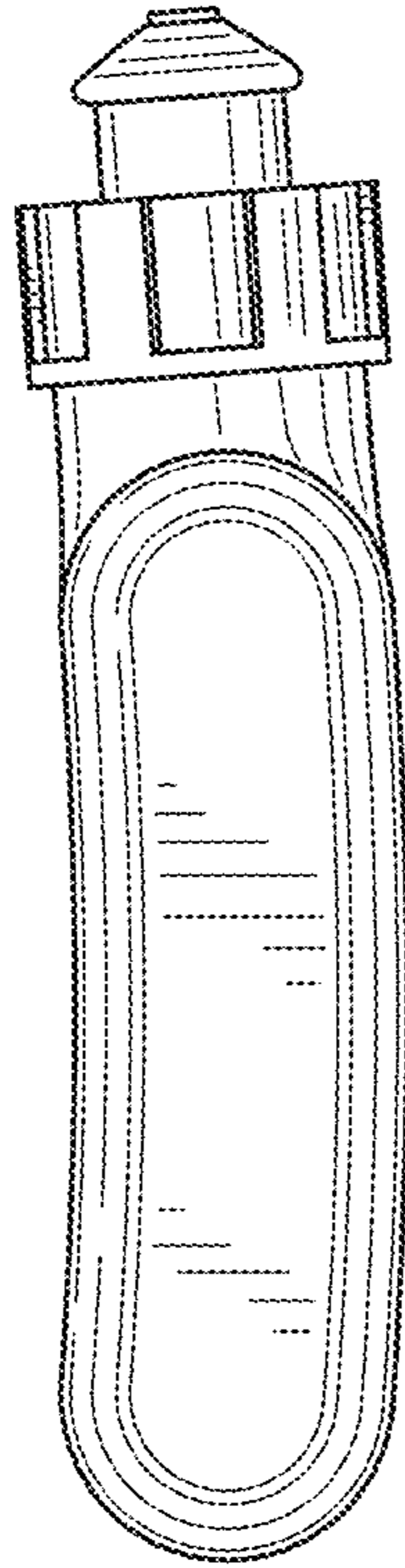

FIG.4

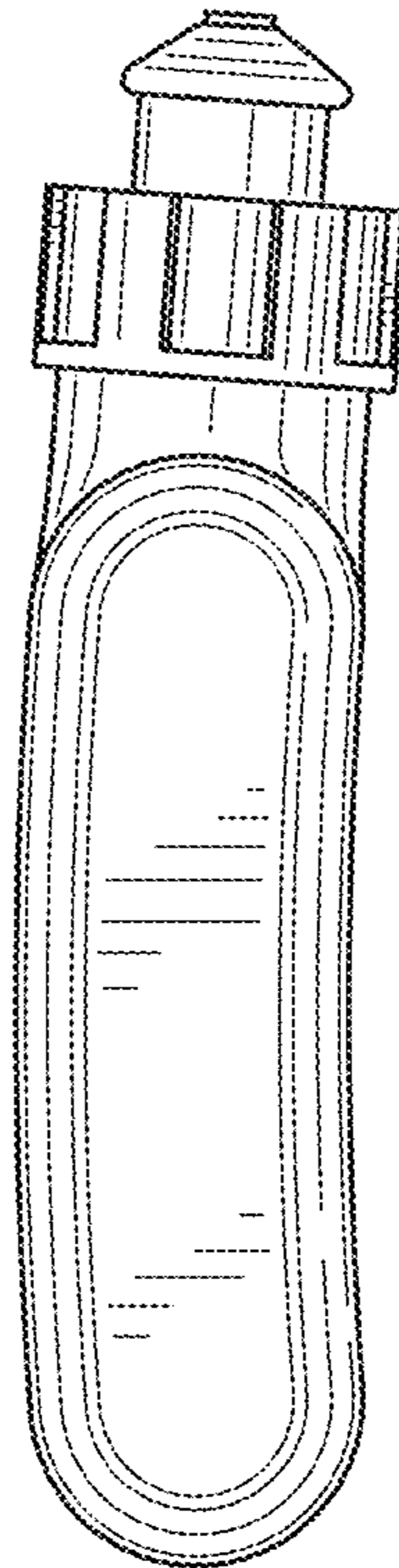

FIG.5

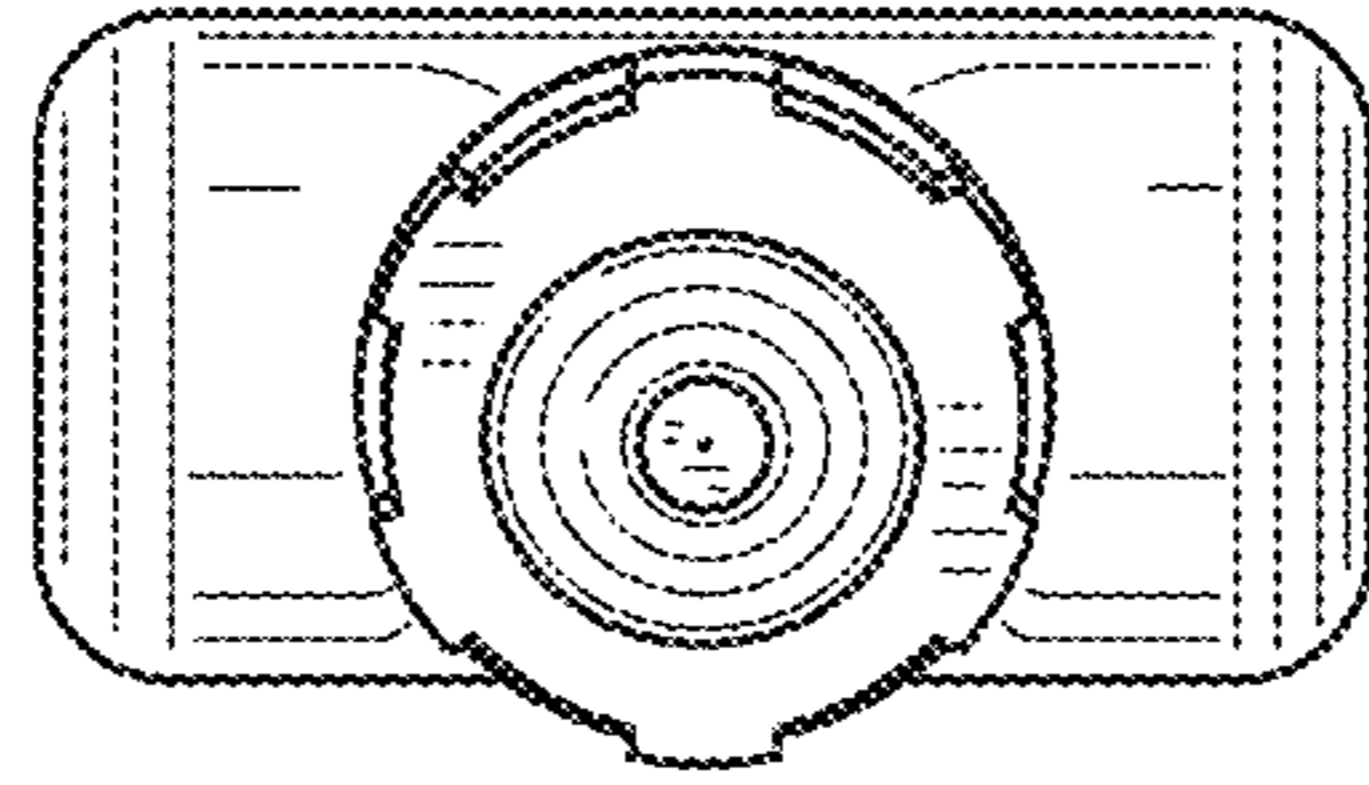

FIG. 6

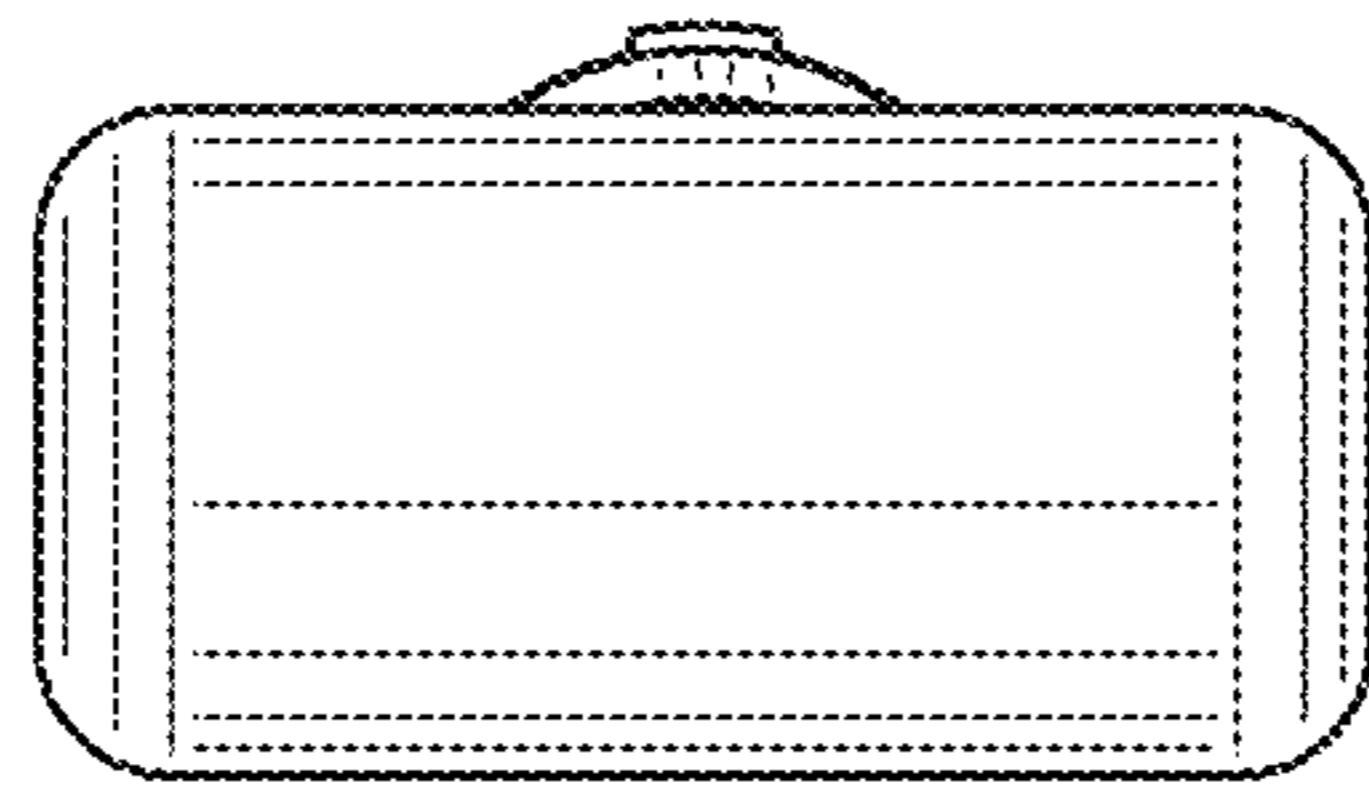

FIG. 7

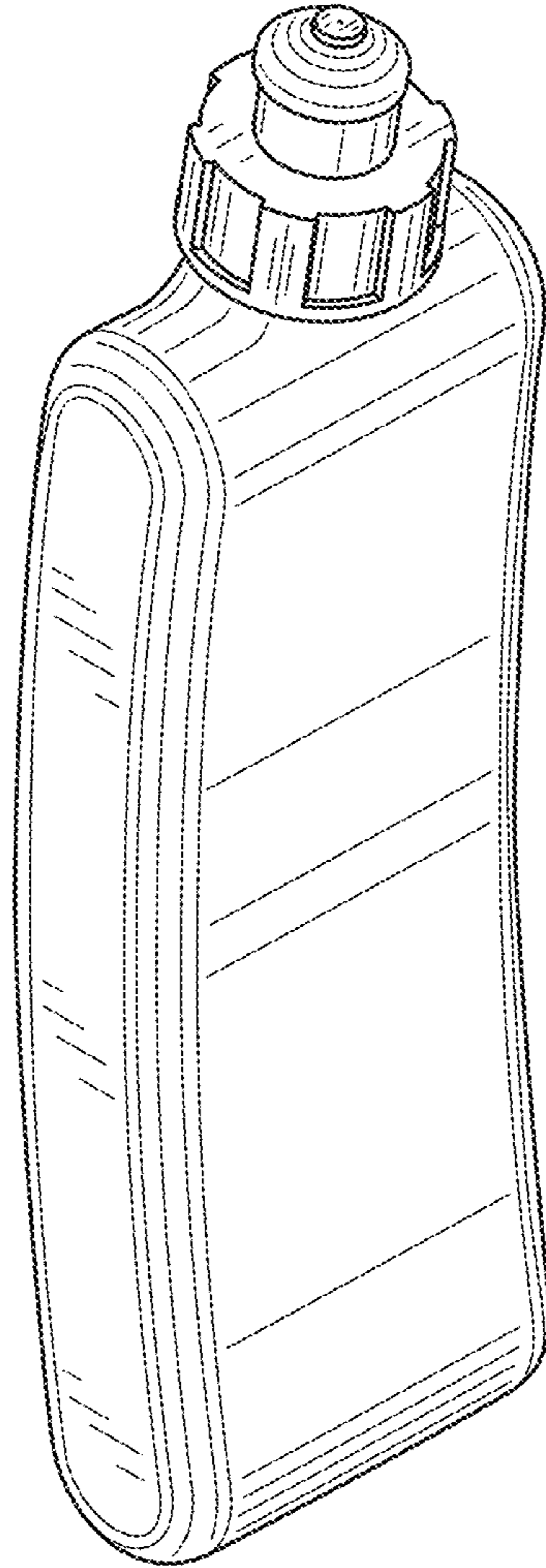

FIG.8

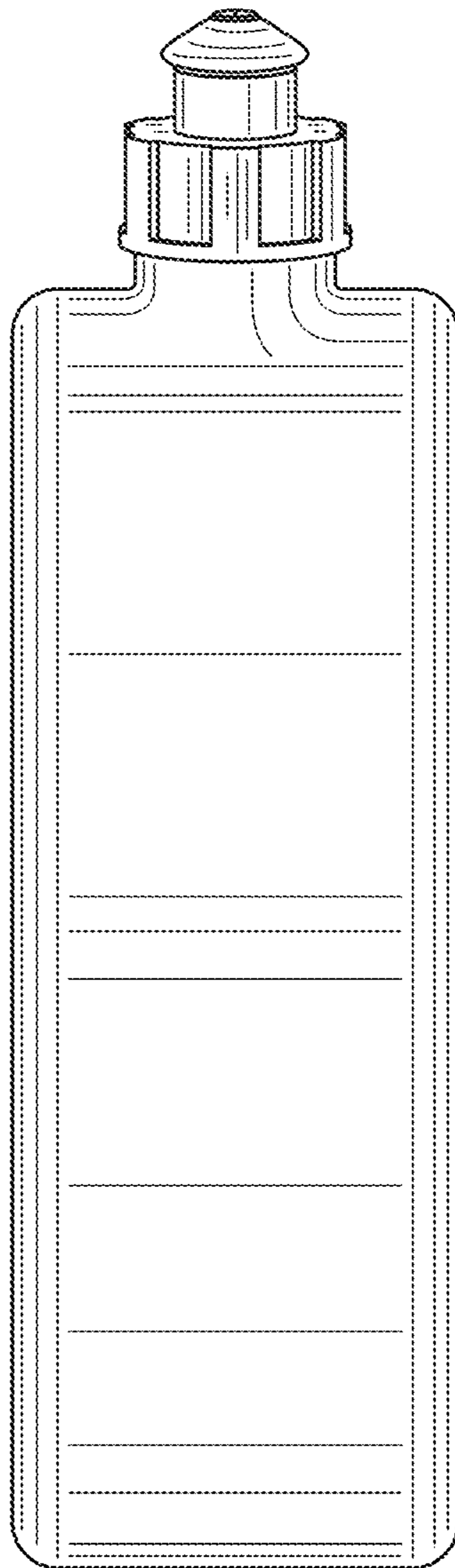

FIG.9

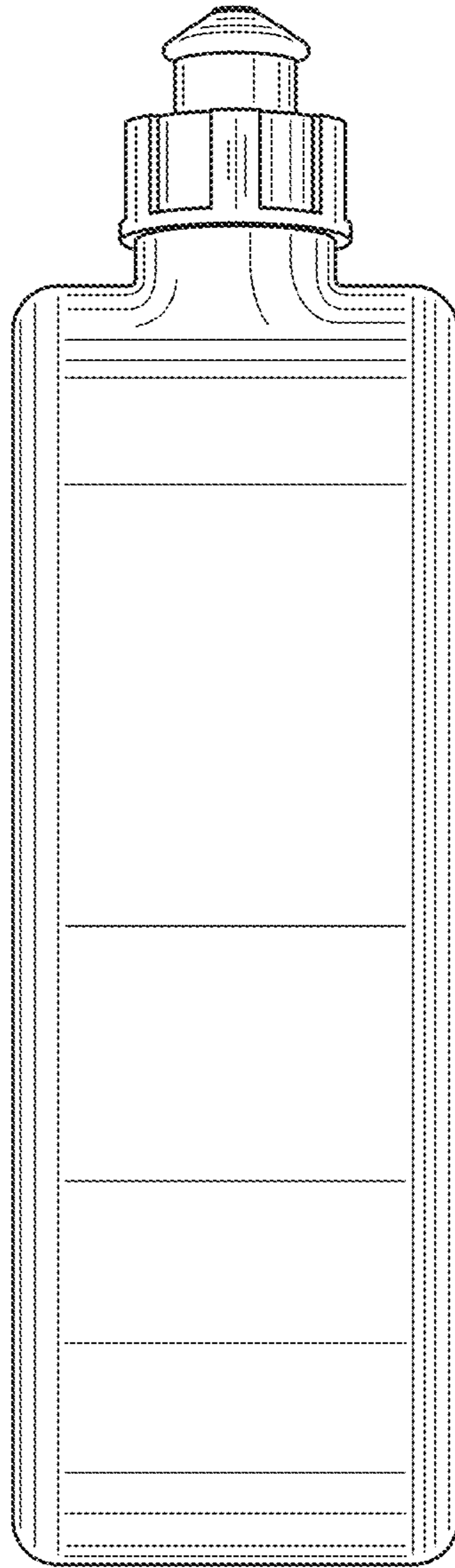

FIG. 10

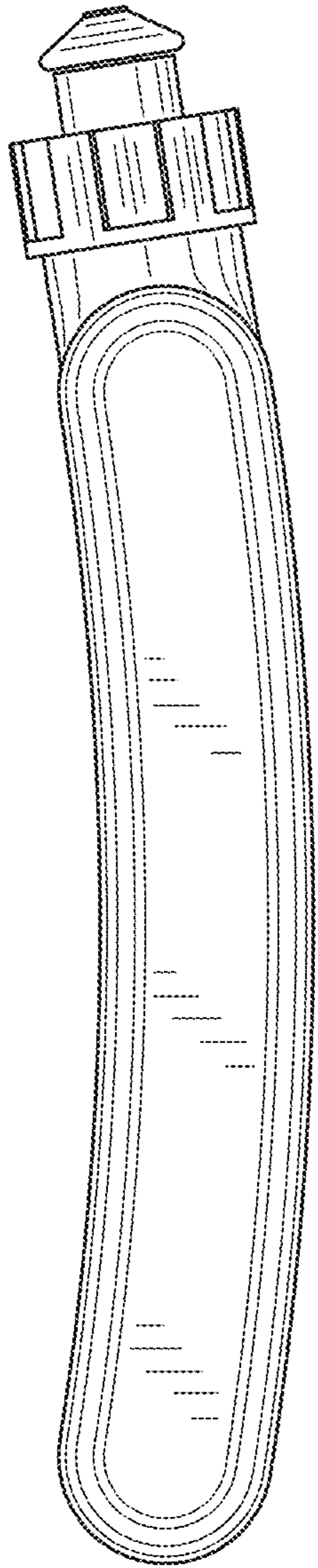

FIG. 11

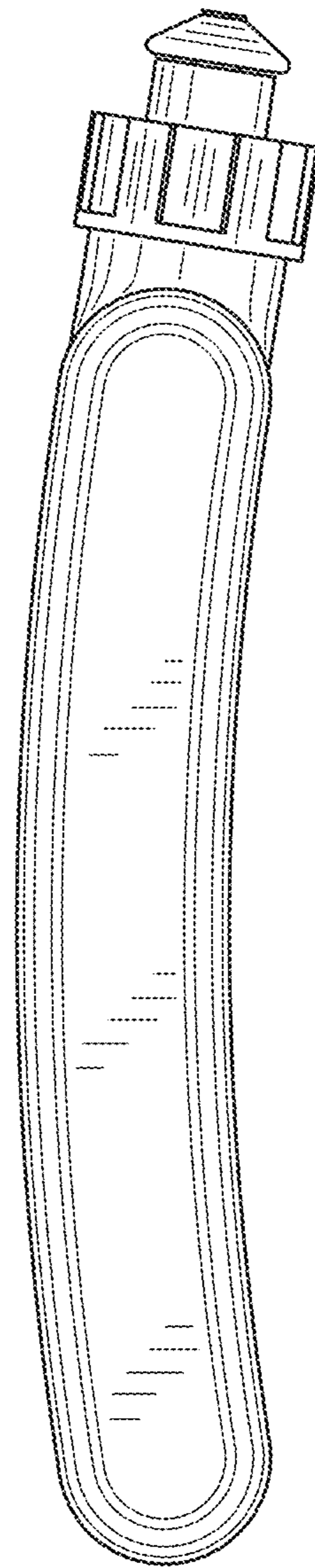

FIG. 12

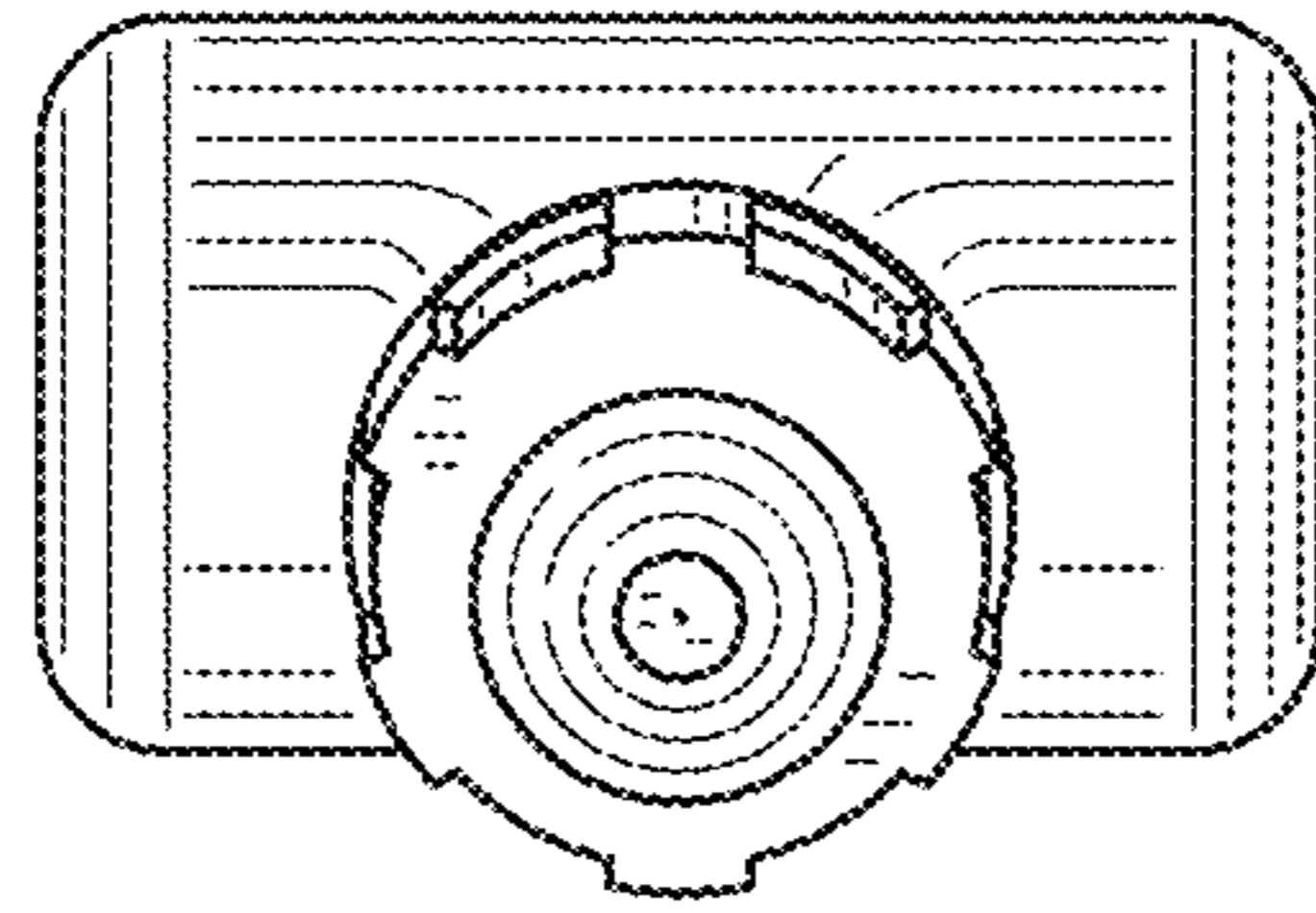

FIG. 13

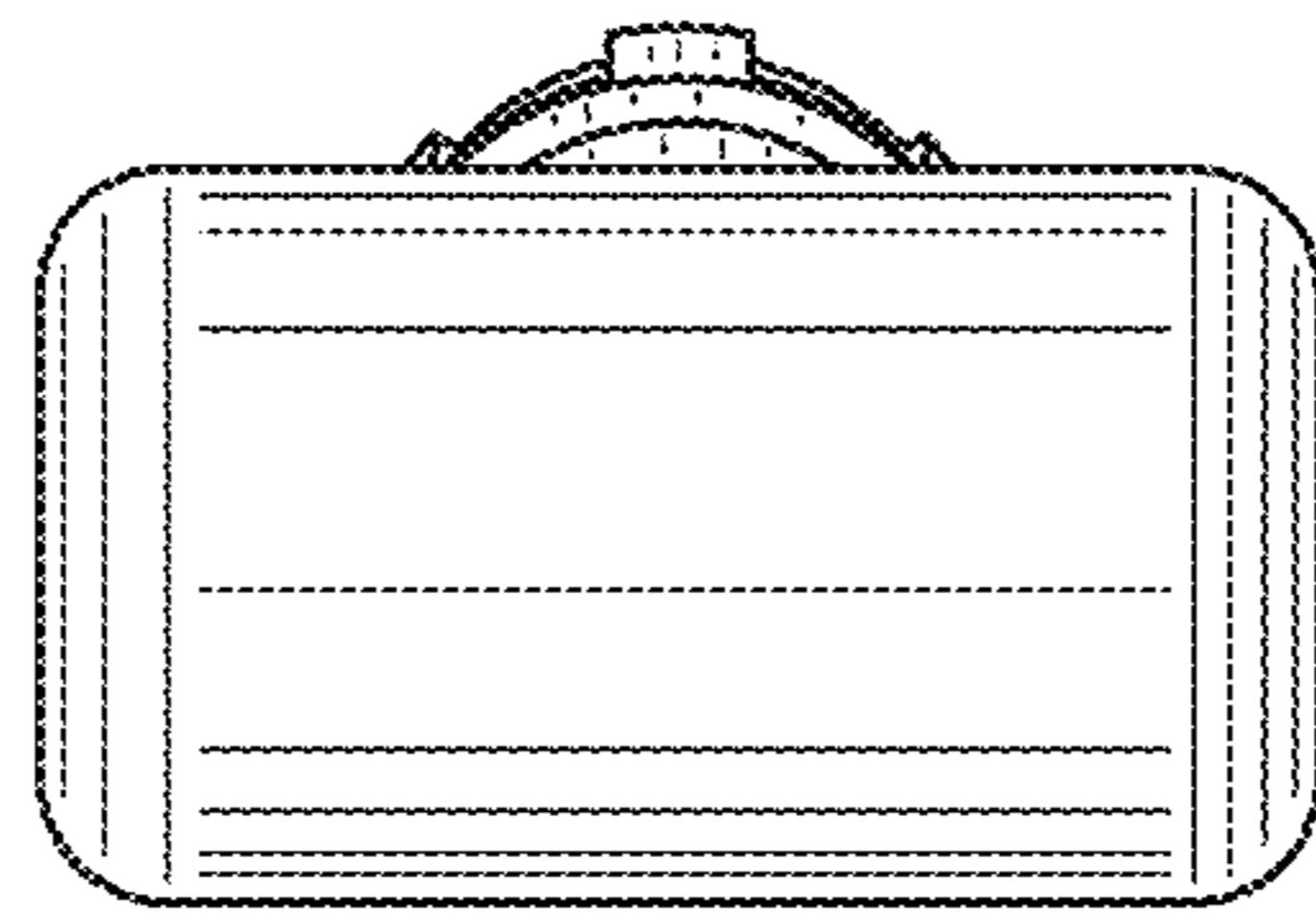

FIG. 14