



US00D790899S

(12) **United States Design Patent**
Trazzi

(10) **Patent No.:** **US D790,899 S**
(45) **Date of Patent:** **** Jul. 4, 2017**

(54) **TEA MACHINE**
(71) Applicant: **TPRESSO AG**, Zürich (CH)
(72) Inventor: **Luca Trazzi**, Milan (IT)
(73) Assignee: **Tpresso AG**, Zürich (CH)
(**) Term: **15 Years**

D607,683 S * 1/2010 Choi D7/306
D633,746 S * 3/2011 Lam D7/309
D652,244 S * 1/2012 Richardson D7/307
D669,727 S * 10/2012 Pagano D7/307
D675,472 S * 2/2013 Strayle D7/309
D706,567 S * 6/2014 Strayle D7/309
D718,971 S * 12/2014 Young D7/306
D738,153 S * 9/2015 Brook D7/309

* cited by examiner

(21) Appl. No.: **29/539,763**
(22) Filed: **Sep. 17, 2015**

Primary Examiner — Marianne Pandozzi
(74) *Attorney, Agent, or Firm* — Dykema Gossett PLLC

(30) **Foreign Application Priority Data**

Jun. 12, 2015 (WO) DM/086 782

(51) **LOC (10) Cl.** **07-01**
(52) **U.S. Cl.**

USPC **D7/311**; D7/306; D7/309

(58) **Field of Classification Search**

USPC D7/305-311, 313; D15/82; 222/129.1,
222/146.6; 99/295

CPC ... A47J 31/44; B67D 1/36; B67D 2210/0065;
B67D 1/0864

See application file for complete search history.

(56) **References Cited**

U.S. PATENT DOCUMENTS

D400,754 S * 11/1998 Alferink D7/309
D402,498 S * 12/1998 Howard D23/209
D499,599 S * 12/2004 Morrison D7/306

(57) **CLAIM**

The ornamental design for a tea machine, as shown and described.

DESCRIPTION

FIG. 1 is a front, side, and top perspective view of a tea machine showing my new design;

FIG. 2 is a rear, side, and bottom perspective view of FIG. 1;

FIG. 3 is a front elevation view of FIG. 1;

FIG. 4 is a rear elevation view of FIG. 1;

FIG. 5 is a right side elevation view of FIG. 1;

FIG. 6 is a left side elevation view of FIG. 1;

FIG. 7 is a top plan view of FIG. 1; and,

FIG. 8 is a bottom plan view of FIG. 1.

The broken lines shown in the drawings illustrate portions of the tea machine that form no part of the claimed design.

1 Claim, 4 Drawing Sheets

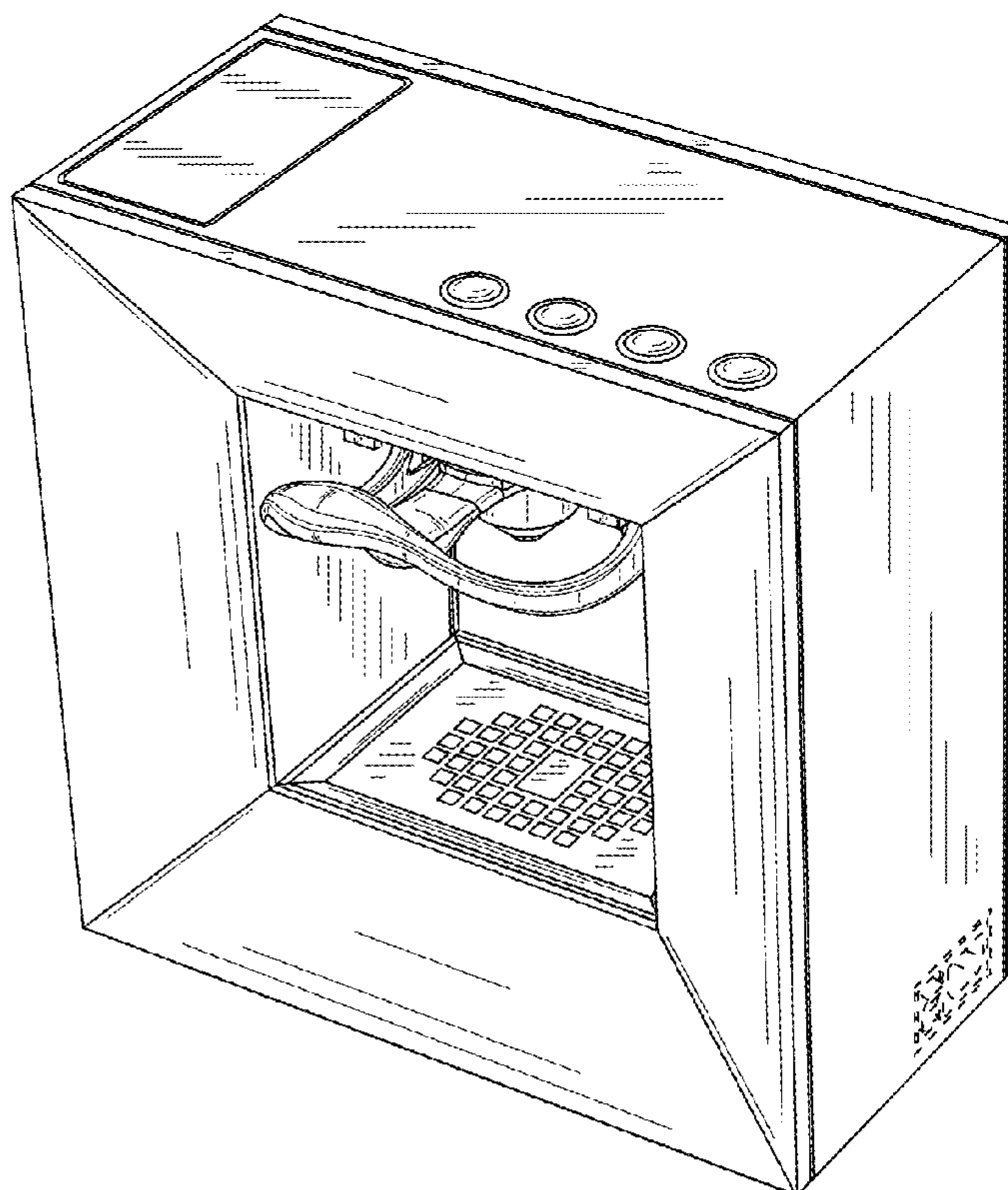

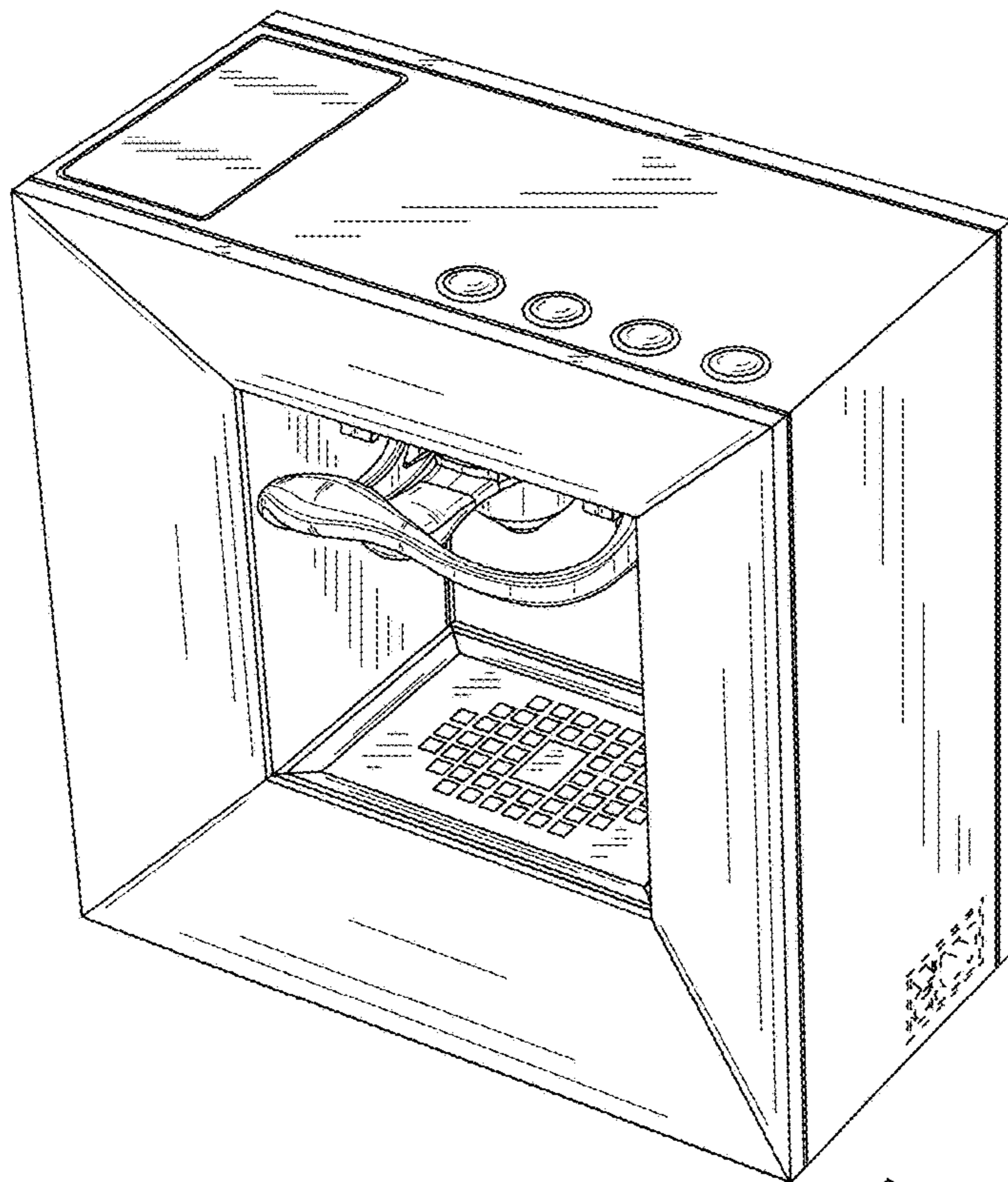

FIG. 1

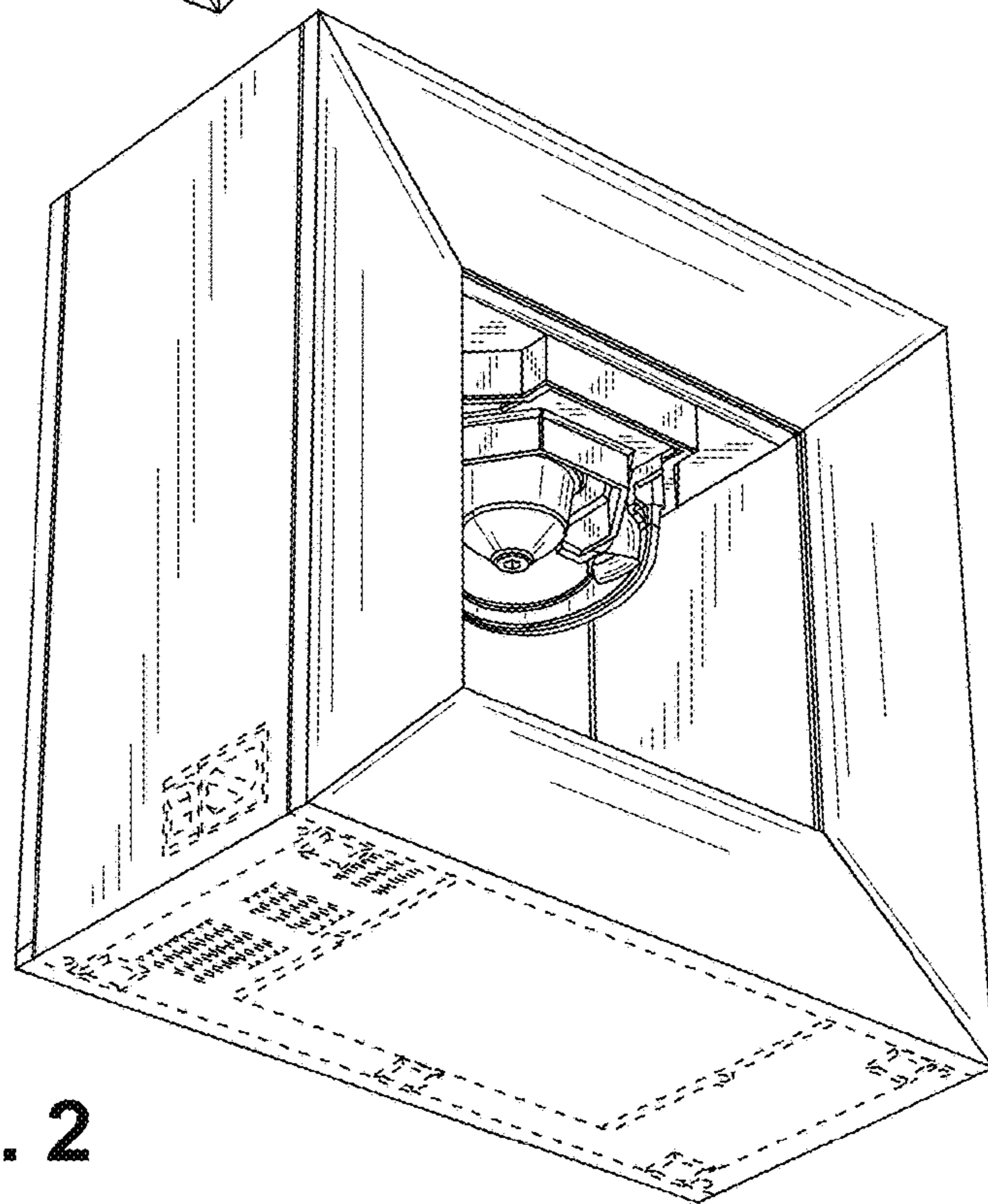

FIG. 2

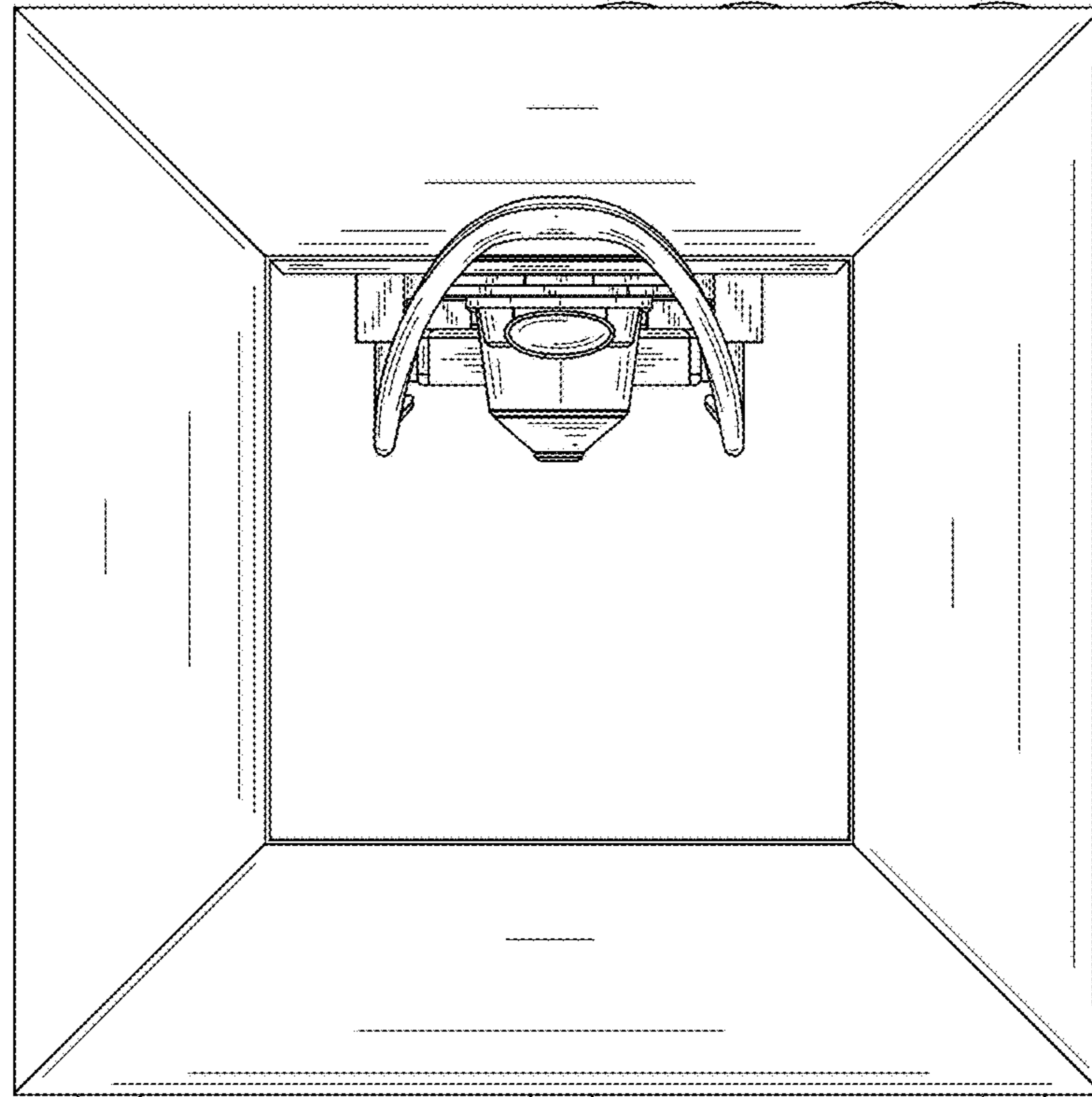

FIG. 3

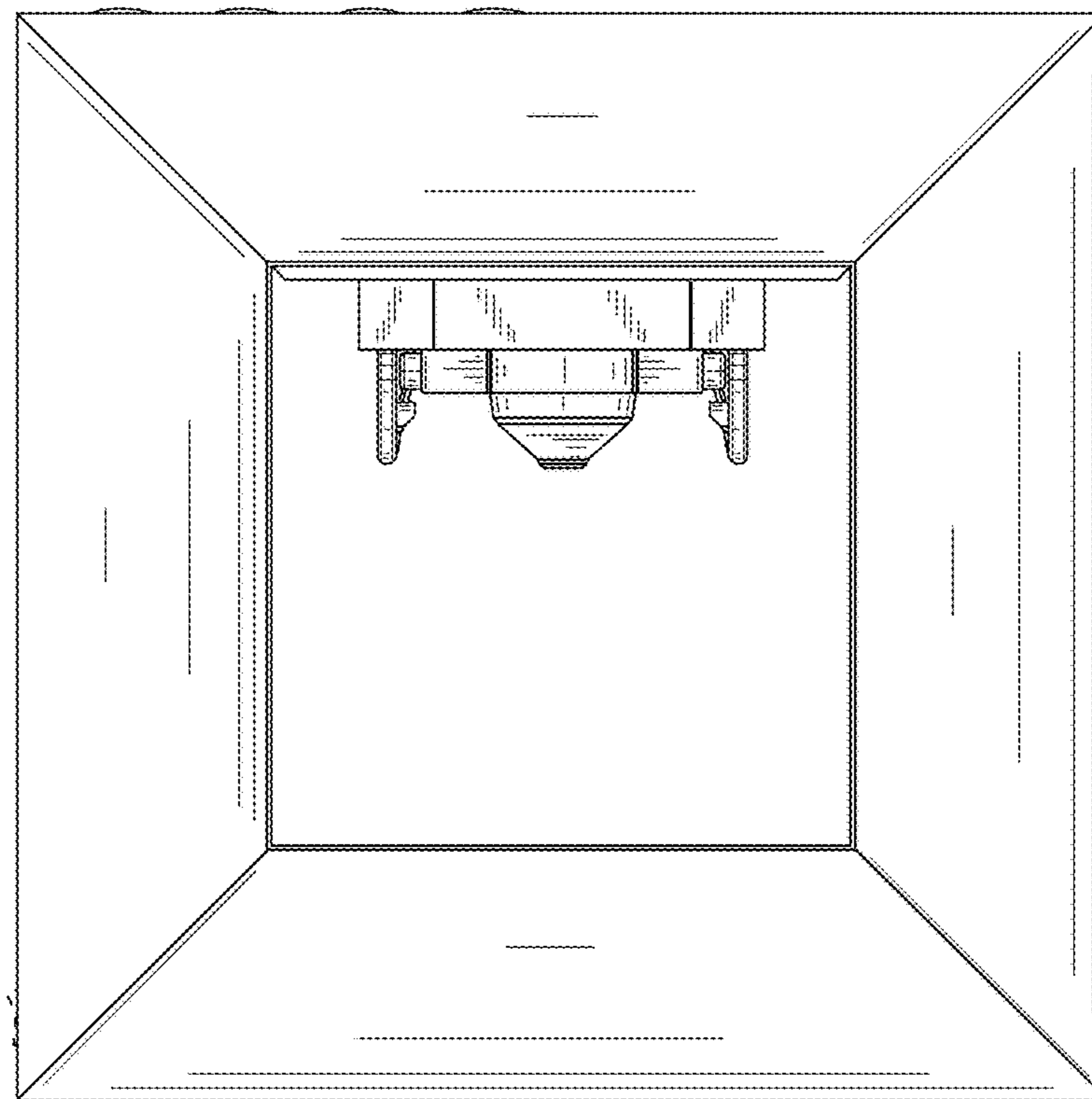

FIG. 4

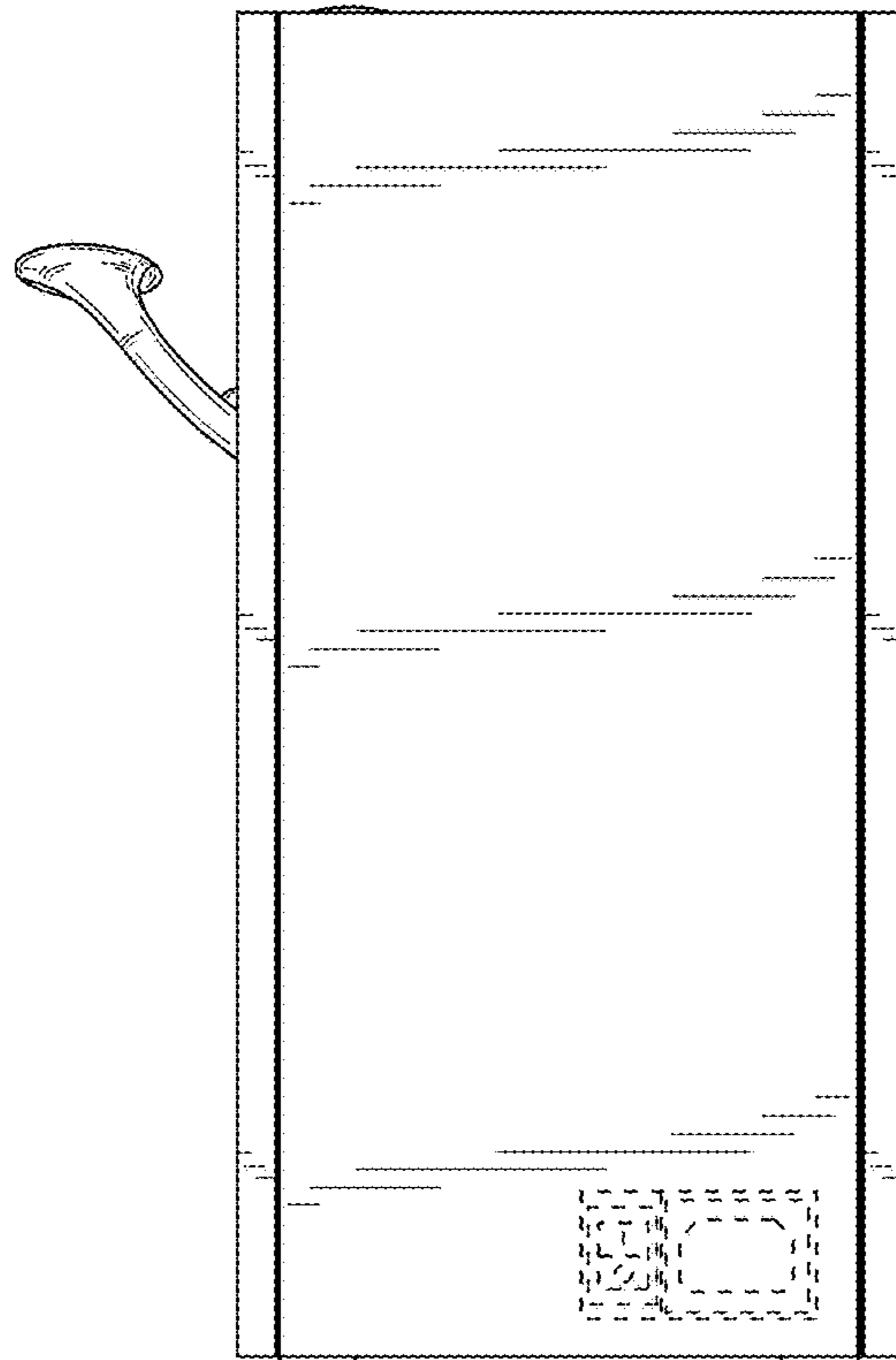

FIG. 5

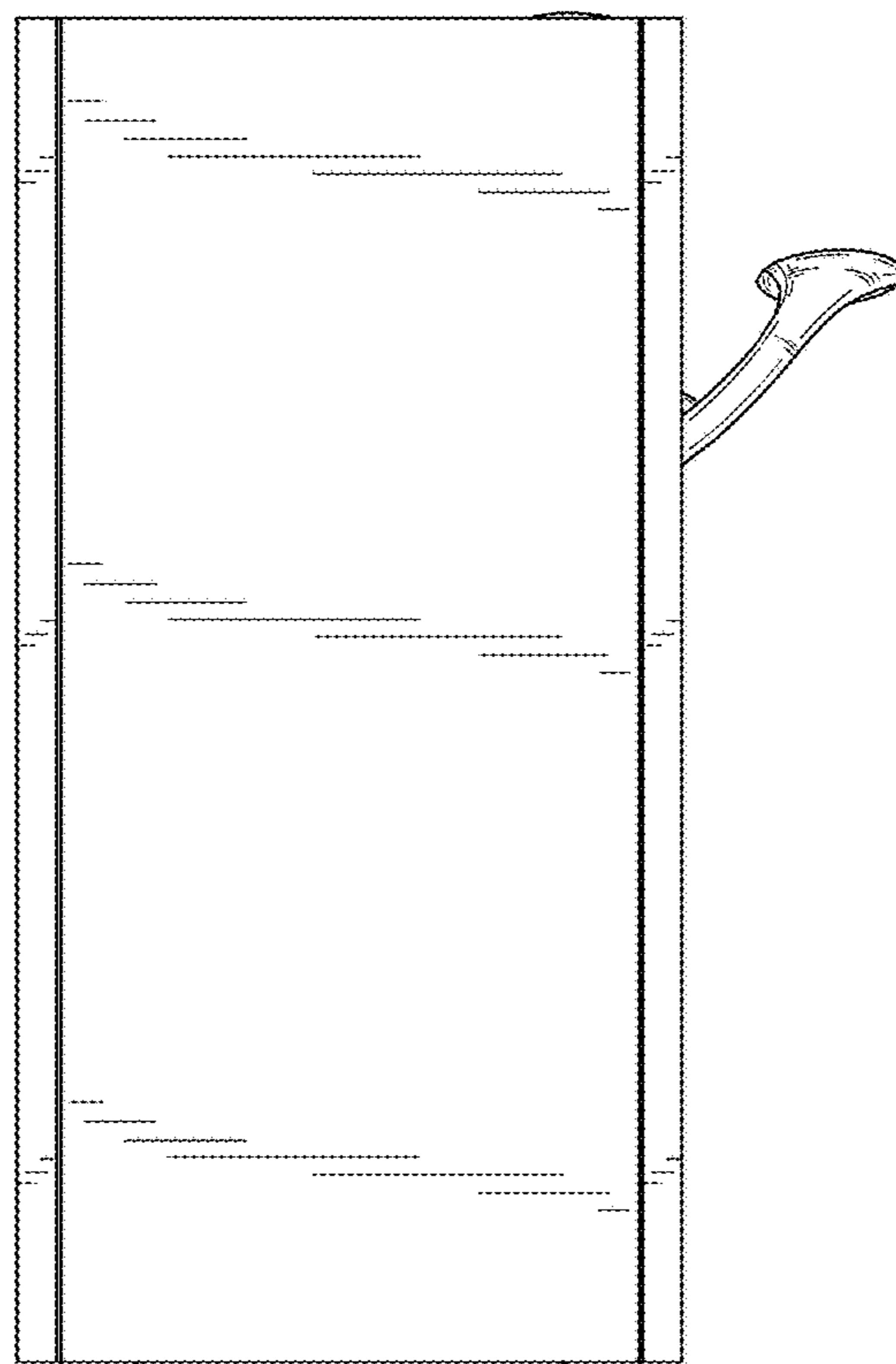

FIG. 6

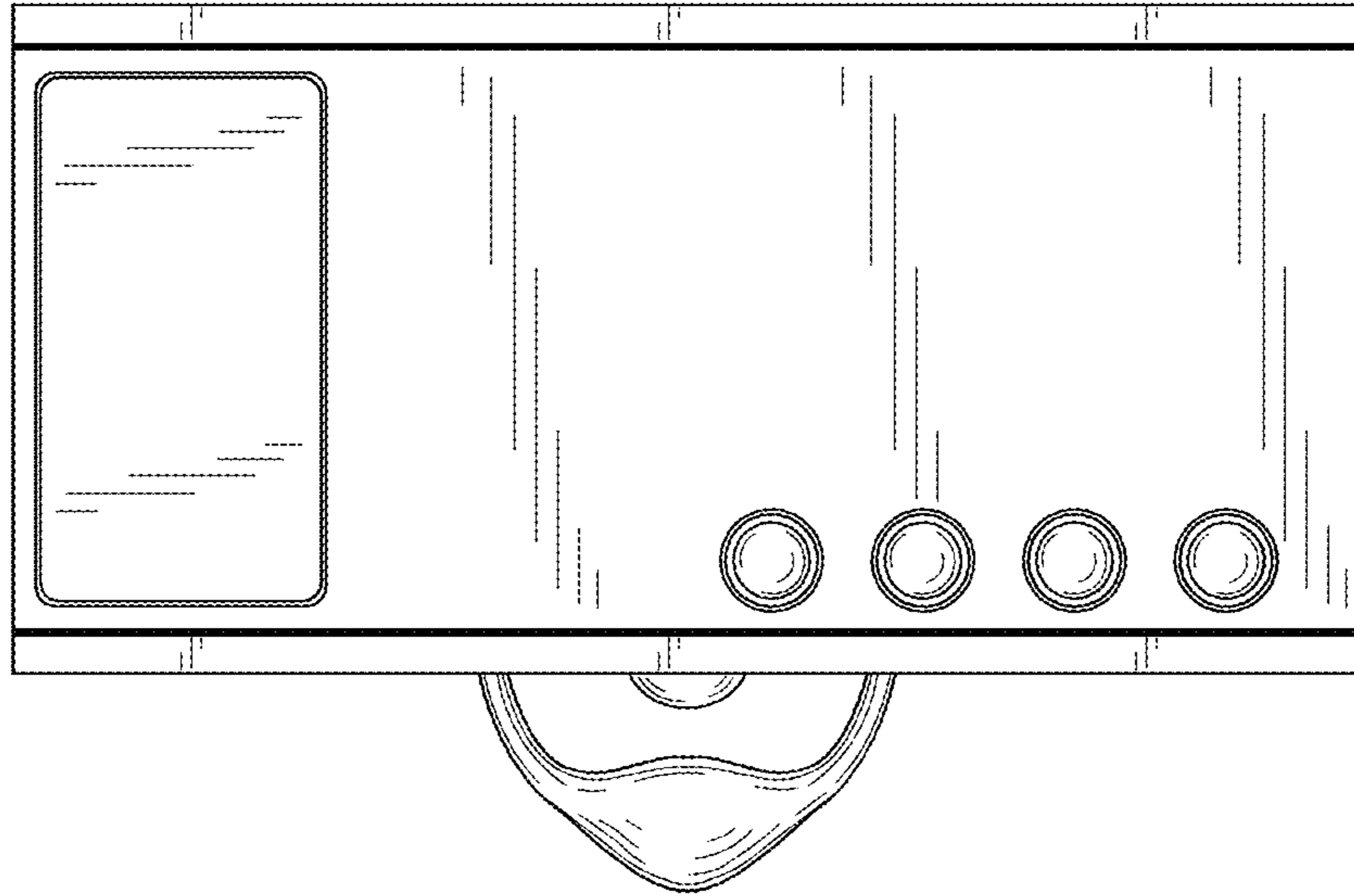

FIG. 7

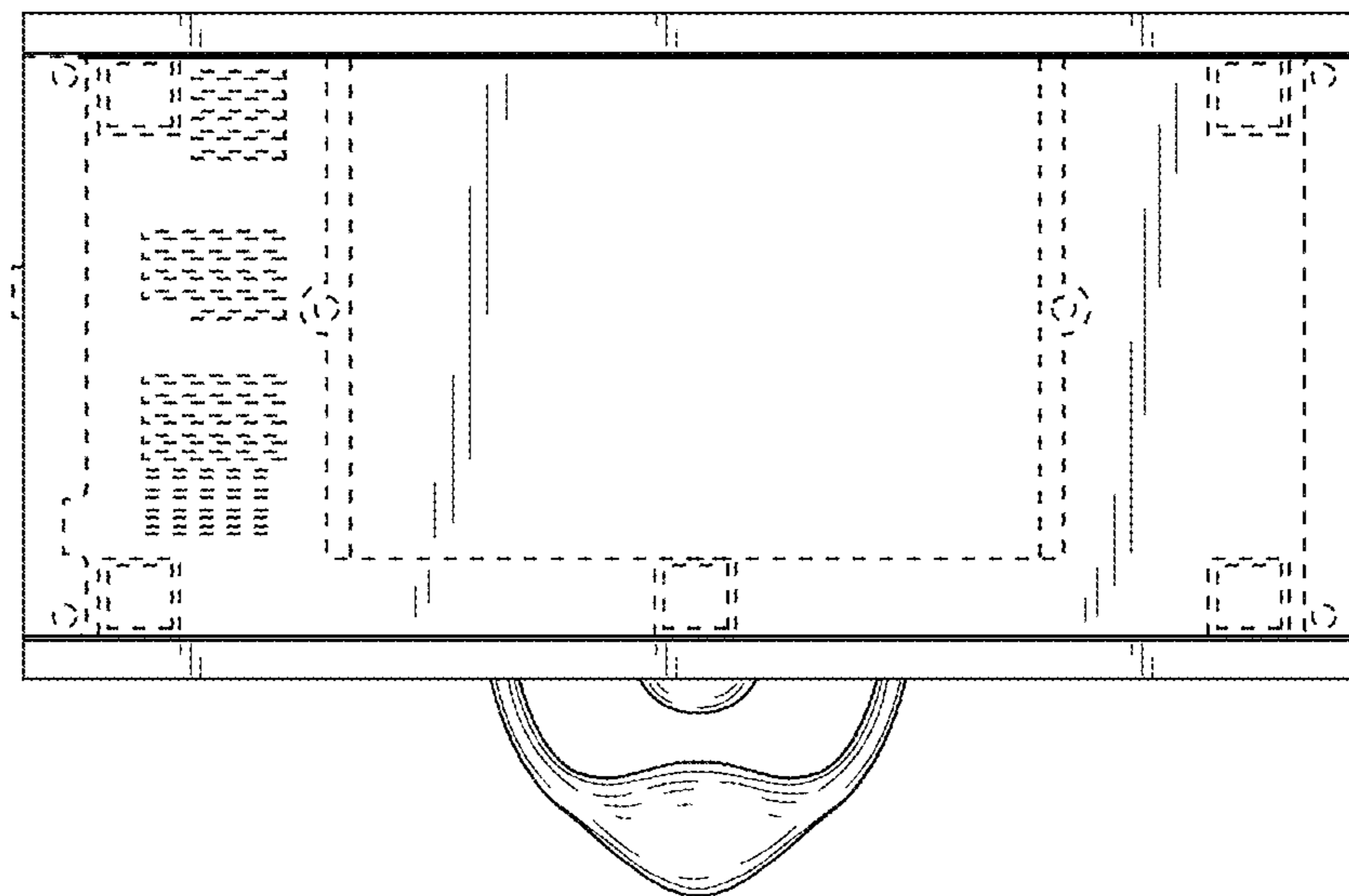

FIG. 8