



US00D790895S

(12) **United States Design Patent** (10) **Patent No.:** **US D790,895 S**
Su (45) **Date of Patent:** **** Jul. 4, 2017**

(54) **CHAIR BACKREST**

(71) Applicant: **Tung-Hua Su**, Tainan (TW)

(72) Inventor: **Tung-Hua Su**, Tainan (TW)

(**) Term: **15 Years**

(21) Appl. No.: **29/563,000**

(22) Filed: **May 1, 2016**

(51) **LOC (10) Cl.** **06-01**

(52) **U.S. Cl.**
USPC **D6/716.4**

(58) **Field of Classification Search**
USPC D6/334-336, 366, 367, 369, 379, 380,
D6/716, 716.1, 716.2, 716.4

CPC .. A47C 7/40; A47C 7/46; A47C 7/022; A47C
7/282; A47C 7/285

See application file for complete search history.

(56) **References Cited**

U.S. PATENT DOCUMENTS

6,550,866 B1 * 4/2003 Su A47C 7/282
297/440.11
D540,080 S * 4/2007 Su D6/366
D540,580 S * 4/2007 Su D6/366
D553,886 S * 10/2007 Su D6/716.4
D557,028 S * 12/2007 Su D6/366

D660,621 S * 5/2012 Su D6/716.4
D683,172 S * 5/2013 Su D6/366
D773,199 S * 12/2016 Neil D6/366
D773,874 S * 12/2016 Su D6/716.4
D779,249 S * 2/2017 Cassaday D6/716.4

* cited by examiner

Primary Examiner — Mimosa De

(57) **CLAIM**

The ornamental design for a chair backrest, as shown and described.

DESCRIPTION

FIG. 1 is a perspective view of the chair backrest showing my new design;
FIG. 2 is a front elevation view thereof;
FIG. 3 is a rear elevation view thereof;
FIG. 4 is a left side elevation view thereof;
FIG. 5 is a right side elevation view thereof;
FIG. 6 is a top plan view thereof; and,
FIG. 7 is a bottom plan view thereof.
The broken line showing of screws is for the purpose of illustrating portions of the chair backrest and forms no part of the claimed design.

1 Claim, 7 Drawing Sheets

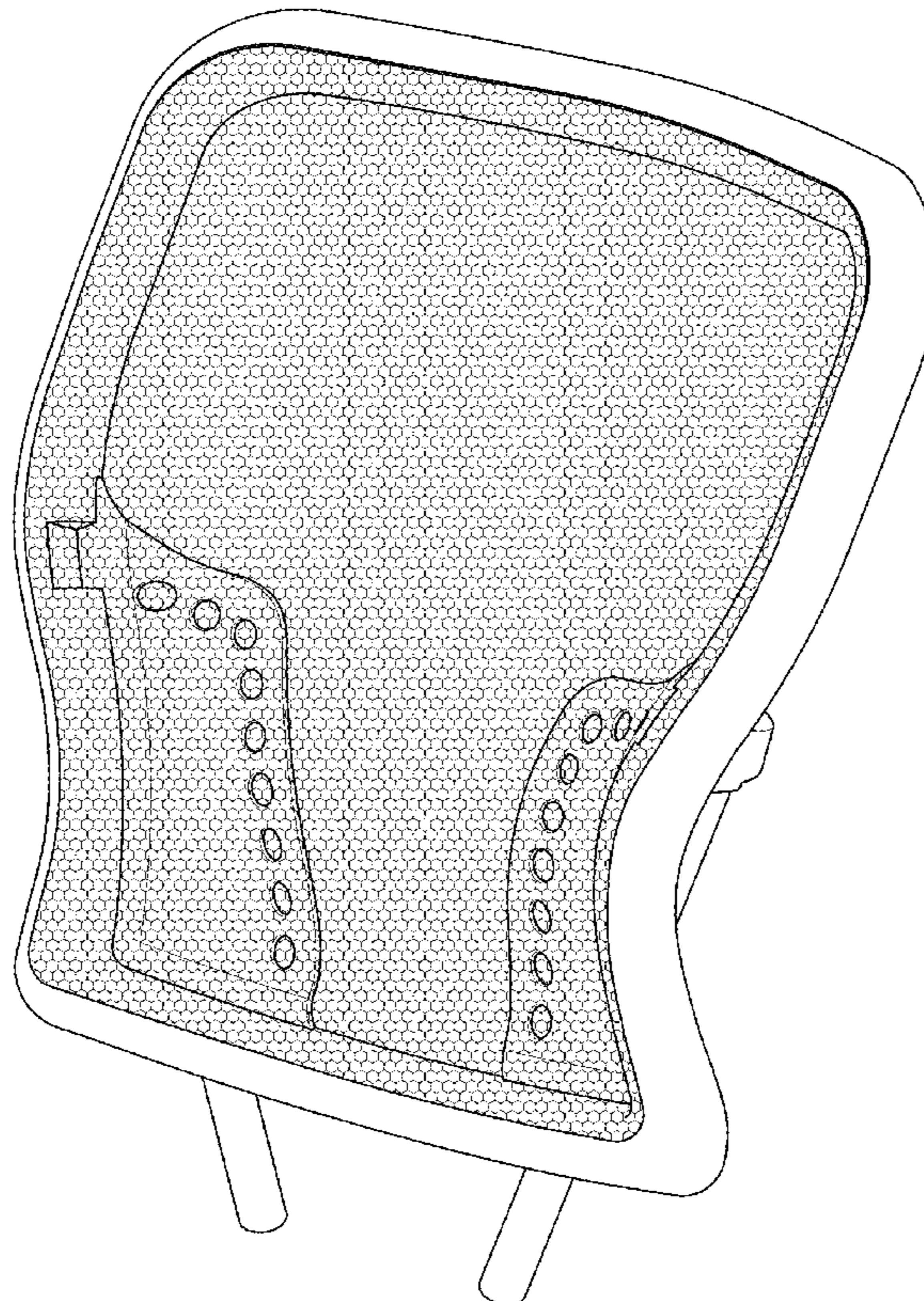

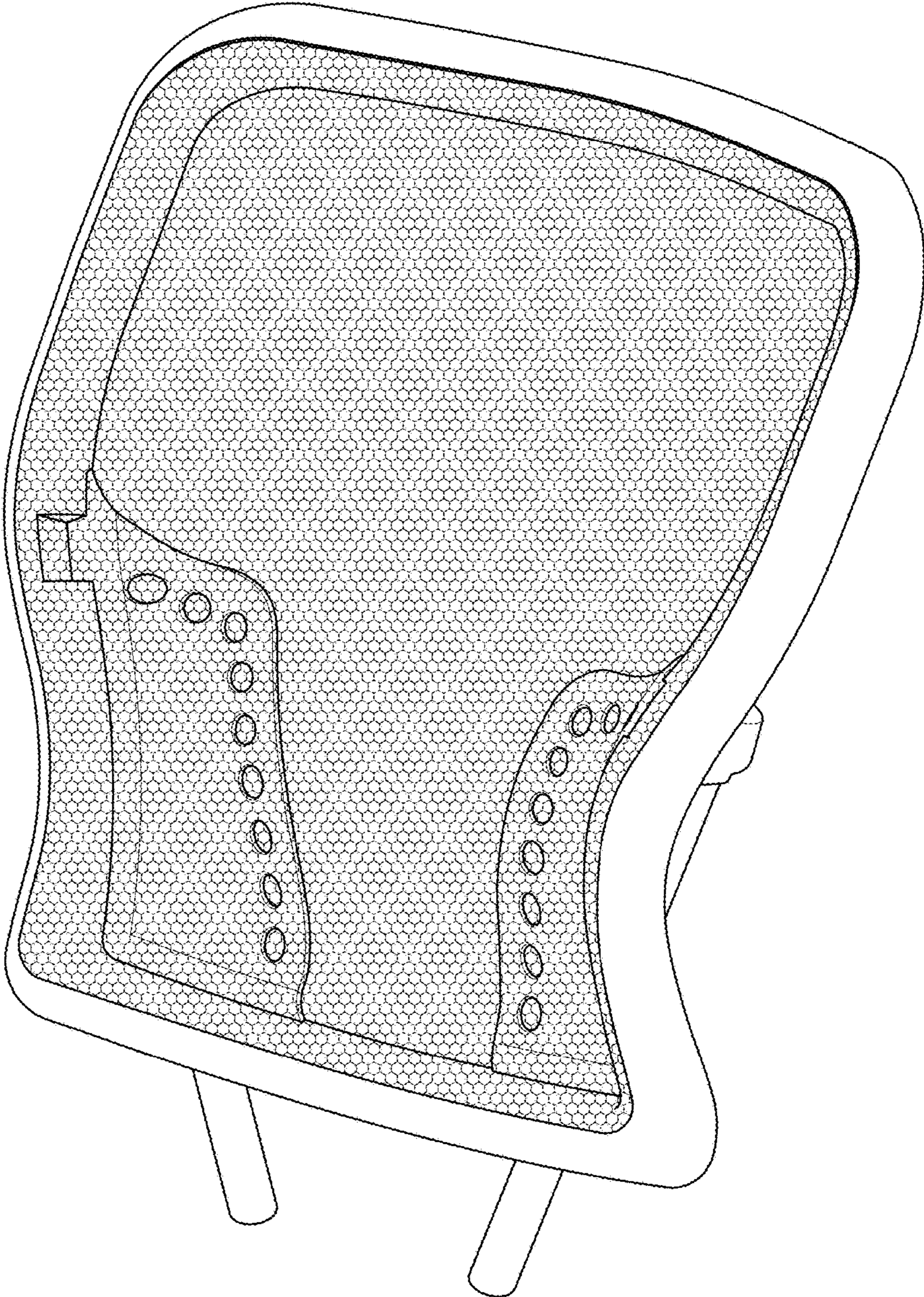

F I G . 1

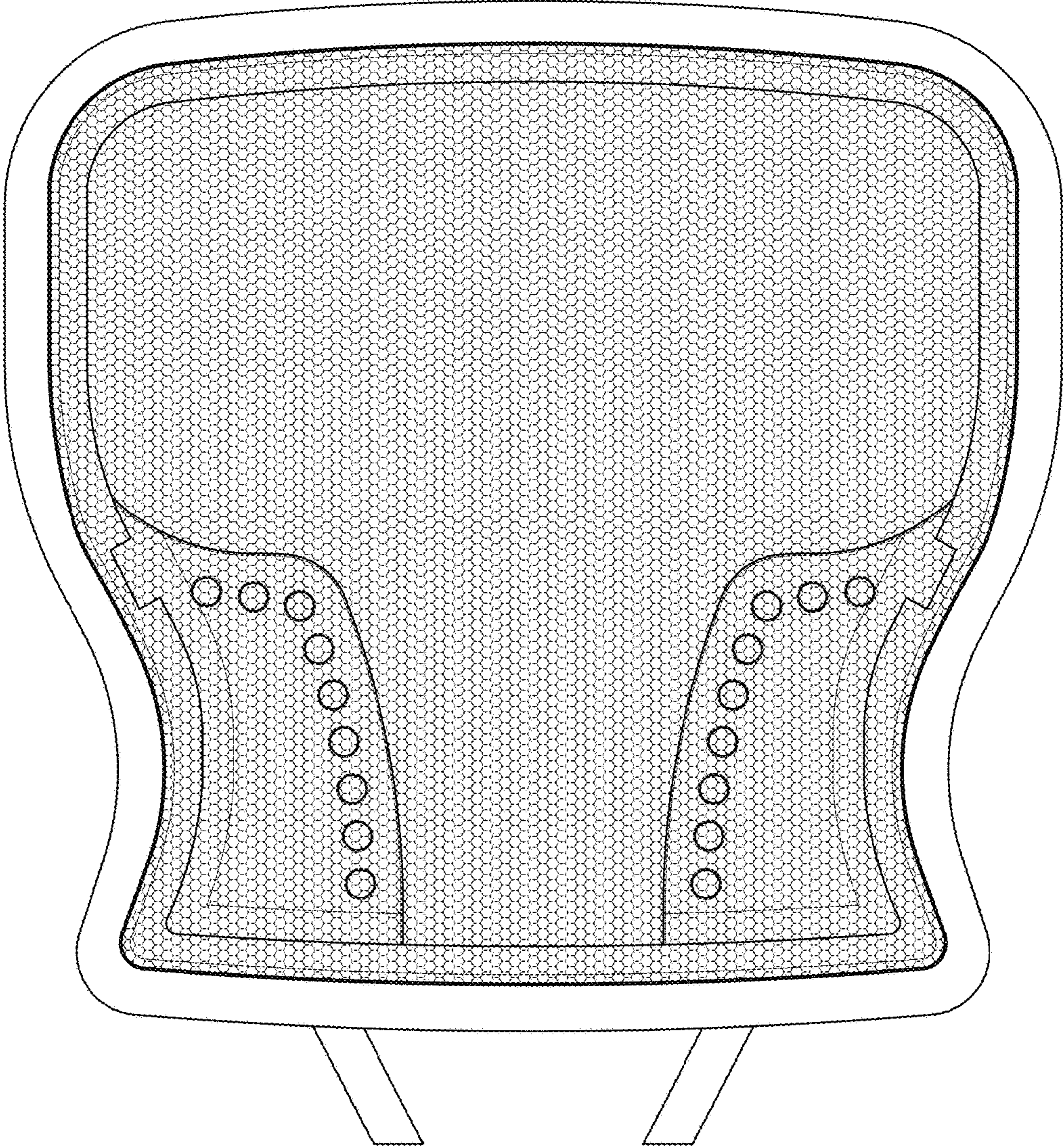

FIG. 2

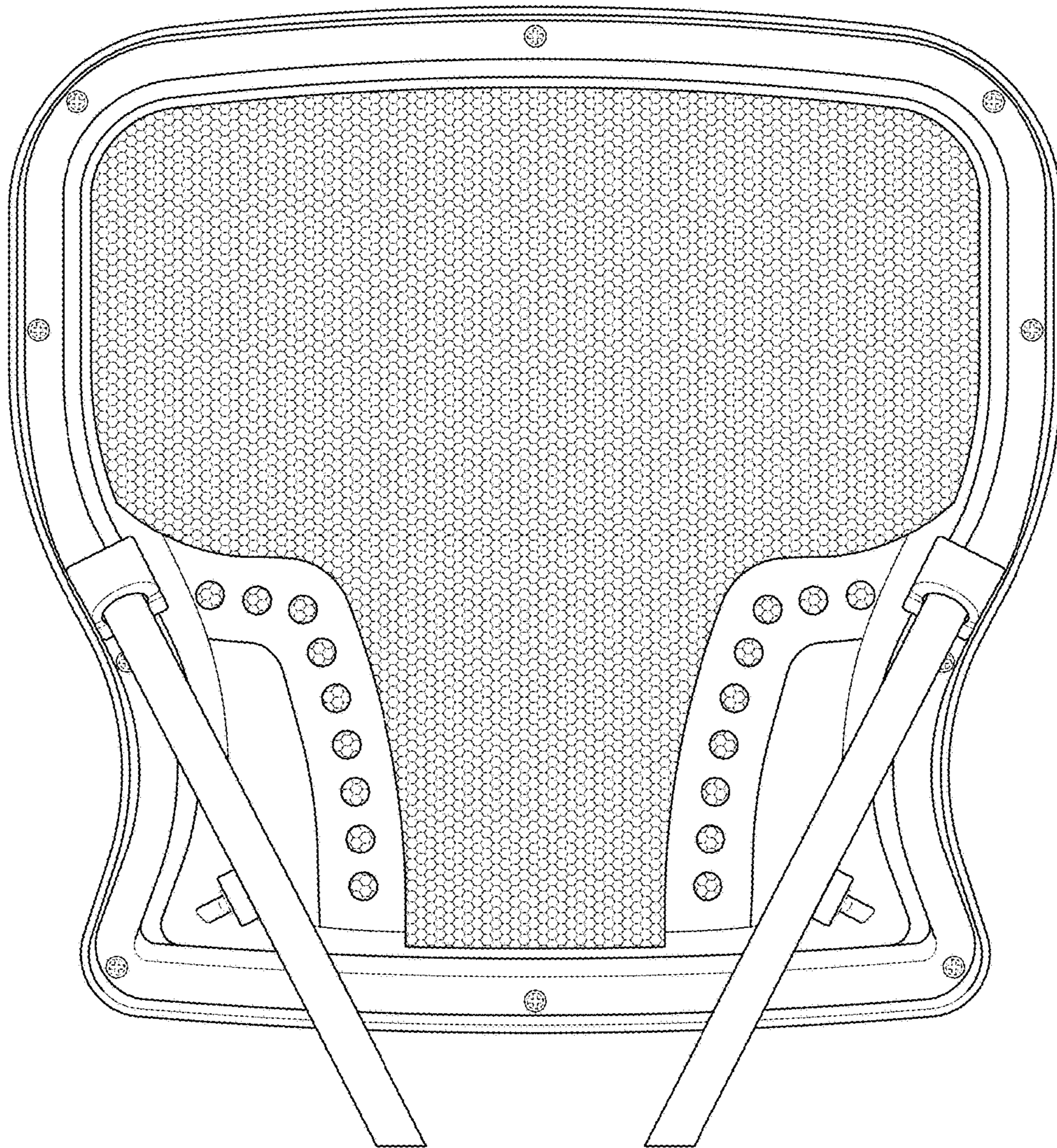
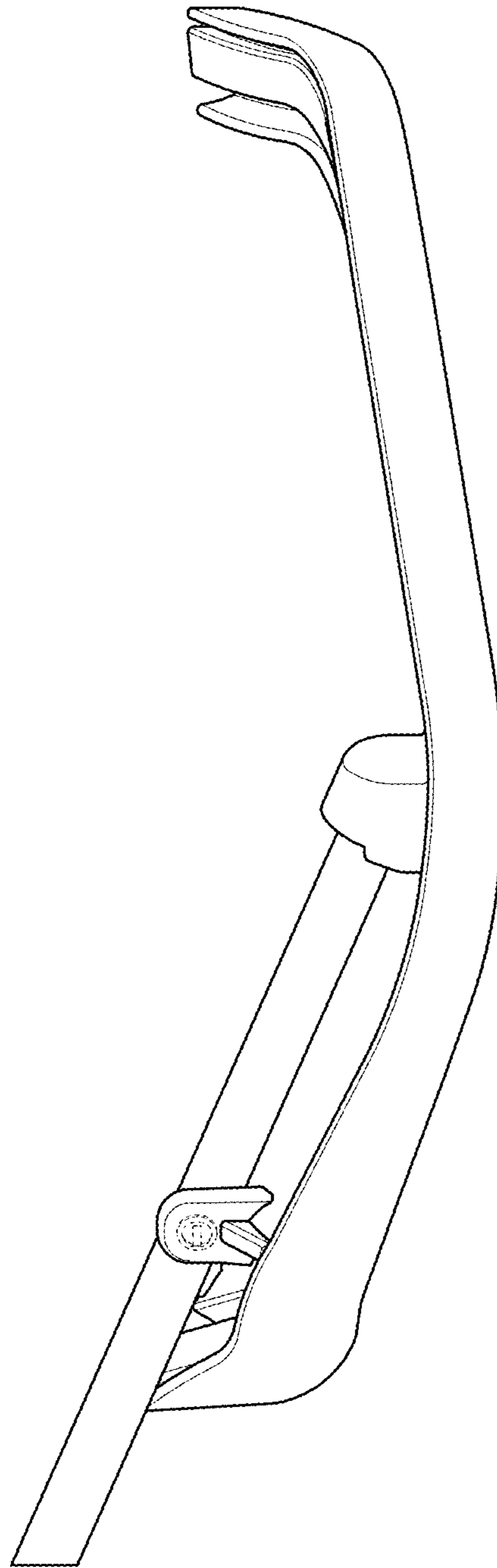
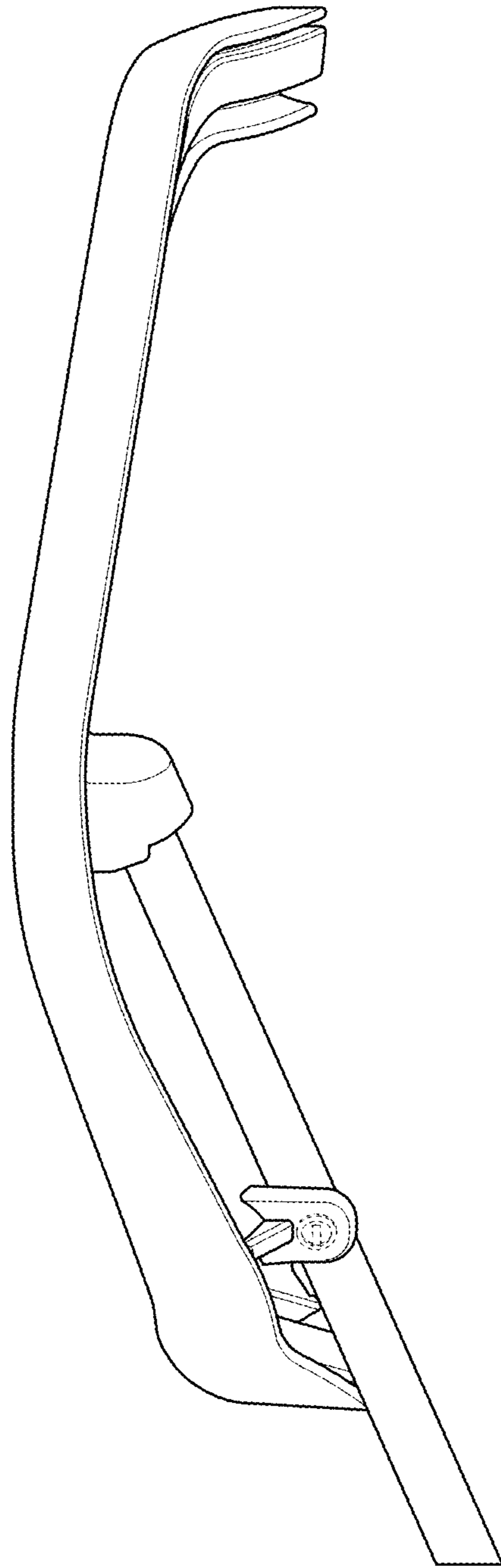

FIG. 3



F I G . 4



F I G . 5

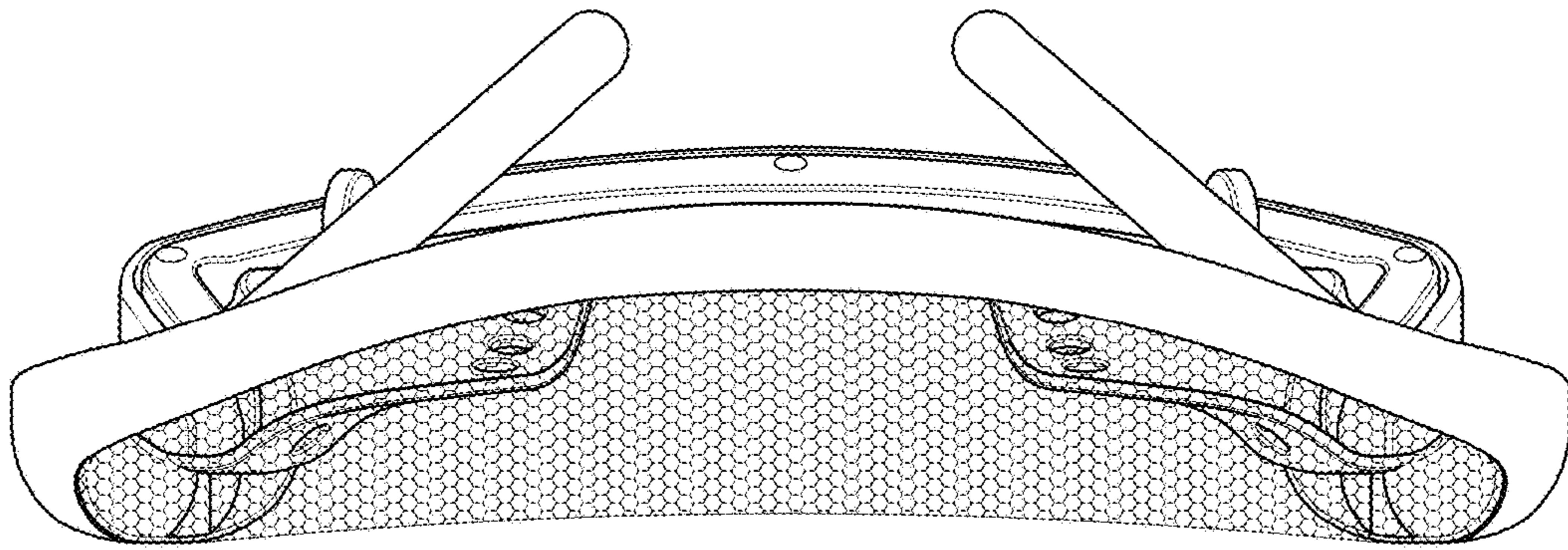

F I G . 6

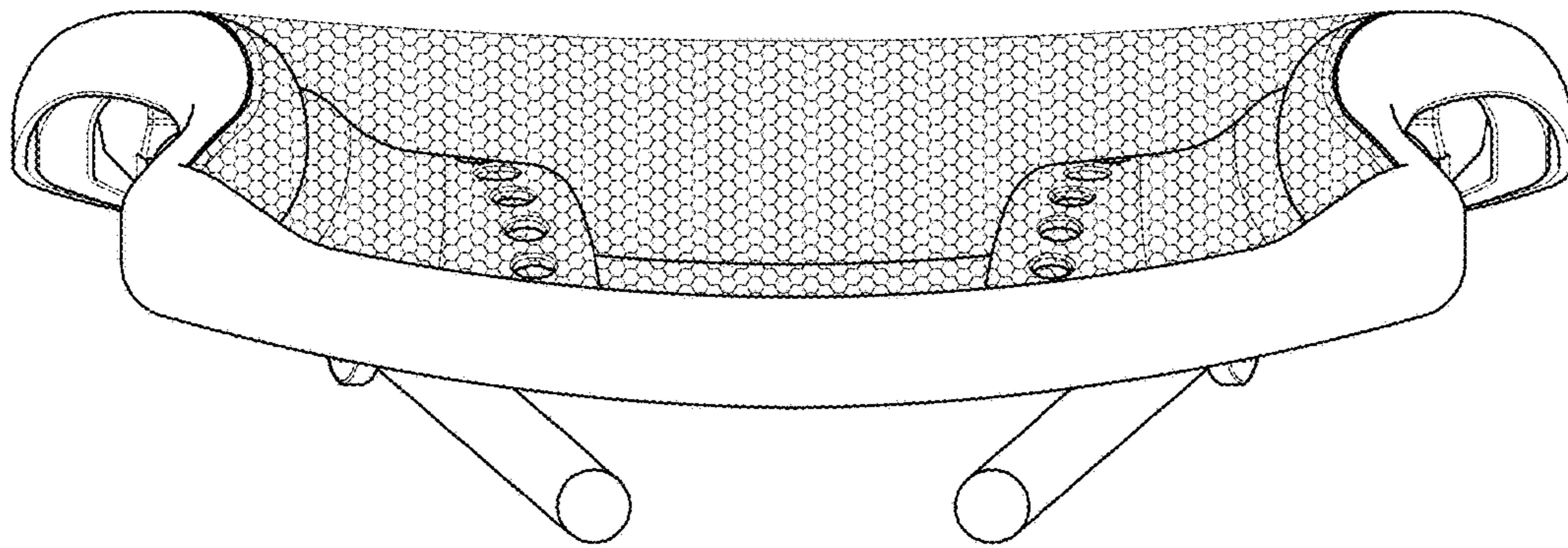

FIG. 7