

US00D790766S

(12) **United States Design Patent** (10) **Patent No.:** **US D790,766 S**
Li (45) **Date of Patent:** **** Jun. 27, 2017**

(54) **ELECTRONIC CIGARETTE**
(71) Applicant: **SHENZHEN INNOKIN TECHNOLOGY CO., LIMITED.,**
Shenzhen (CN)
(72) Inventor: **Jianwei Li, Shenzhen (CN)**
(**) Term: **15 Years**
(21) Appl. No.: **29/544,035**
(22) Filed: **Oct. 29, 2015**
(51) **LOC (10) Cl.** **27-02**
(52) **U.S. Cl.**
USPC **D27/163**
(58) **Field of Classification Search**
USPC D27/100, 101, 162, 163-194
CPC A24F 47/00; A24F 47/002; A24B 15/243;
A24B 15/16; A24B 15/167; A61M
11/042; A61M 15/06
See application file for complete search history.

(56) **References Cited**
U.S. PATENT DOCUMENTS

D347,490 S * 5/1994 Gee D27/194
D368,552 S * 4/1996 Adams D27/194
D422,113 S * 3/2000 Higgins D27/186
D649,708 S * 11/2011 Oneil D27/163
8,689,804 B2 * 4/2014 Fernando A24F 47/008
131/184.1
8,881,738 B2 * 11/2014 Bryman A24F 3/00
131/184.2
D728,855 S * 5/2015 Liu D27/163
D753,336 S * 4/2016 Chen D27/101
D758,656 S * 6/2016 Freshwater D27/163
D761,999 S * 7/2016 Liu D27/101
D768,331 S * 10/2016 Chen D27/101
D769,520 S * 10/2016 Hua D27/167
D771,309 S * 11/2016 Ward D27/167
D771,867 S * 11/2016 Leidel D27/163

D773,114 S * 11/2016 Leidel D27/163
D773,116 S * 11/2016 Liu D27/167
D775,414 S * 12/2016 Ampolini D13/108
D775,762 S * 1/2017 Chen D27/101
2014/0014125 A1 * 1/2014 Fernando A24F 47/008
131/328
2014/0283824 A1 * 9/2014 Wheelock A61M 11/041
128/202.21
2015/0136124 A1 * 5/2015 Aronie A24F 47/008
128/202.21
2016/0165955 A1 * 6/2016 Horne A45F 5/02
131/328
2016/0213866 A1 * 7/2016 Tan A61M 11/005
2016/0271347 A1 * 9/2016 Raichman A61M 15/06
2016/0353800 A1 * 12/2016 Di Carlo A24F 47/008
2016/0366946 A1 * 12/2016 Murison A24F 15/12

* cited by examiner

Primary Examiner — Robert M Spear
Assistant Examiner — Marissa J Cash
(74) *Attorney, Agent, or Firm* — Prakash Nama; Global IP Services, PLLC

(57) **CLAIM**

The ornamental design for an electronic cigarette, as shown and described.

DESCRIPTION

FIG. 1 is a front elevational view of an electronic cigarette showing my new design;
FIG. 2 is a rear elevational view thereof;
FIG. 3 is a left side view thereof;
FIG. 4 is a right side view thereof;
FIG. 5 is a top plan view thereof;
FIG. 6 is a bottom plan view thereof;
FIG. 7 is a perspective view thereof; and,
FIG. 8 is a perspective view with the main body detached.
The broken lines shown form no part of the claimed design.

1 Claim, 5 Drawing Sheets

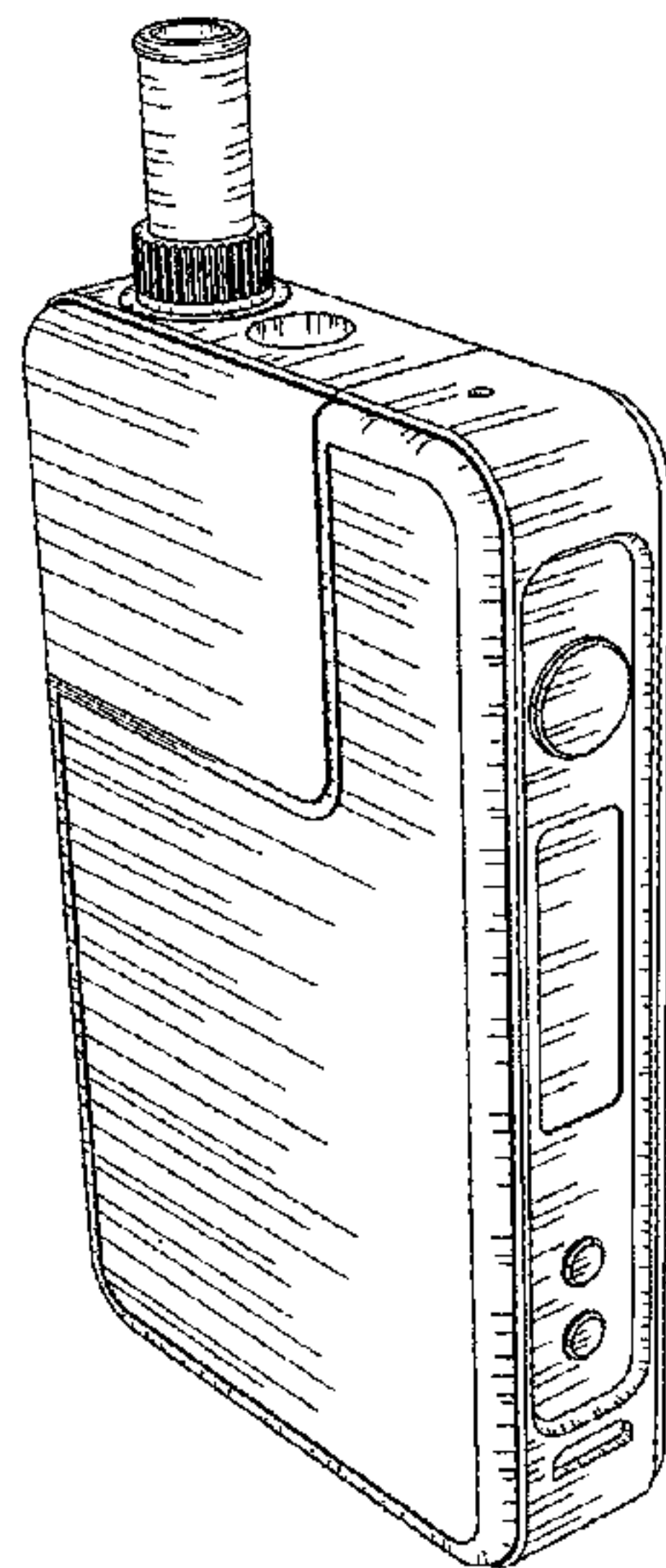

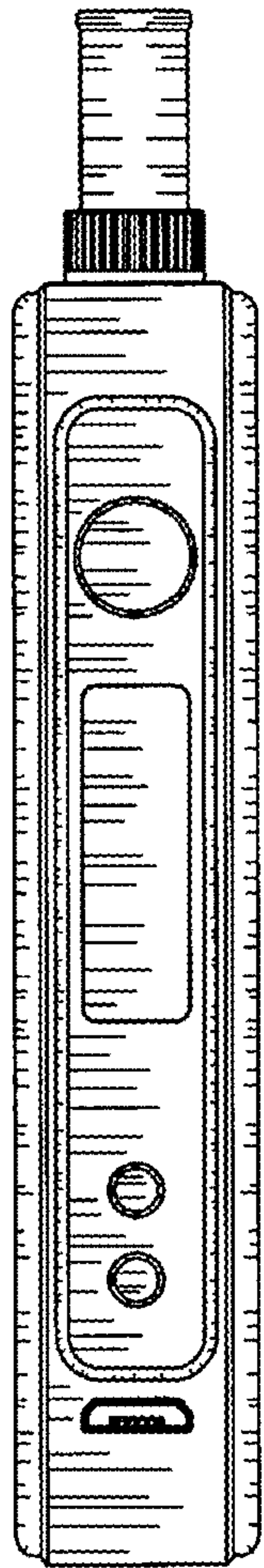

FIG. 1

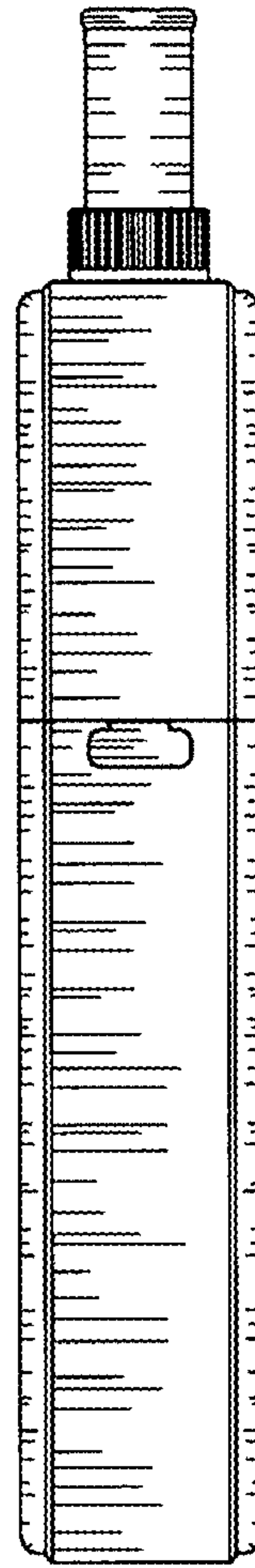

FIG. 2

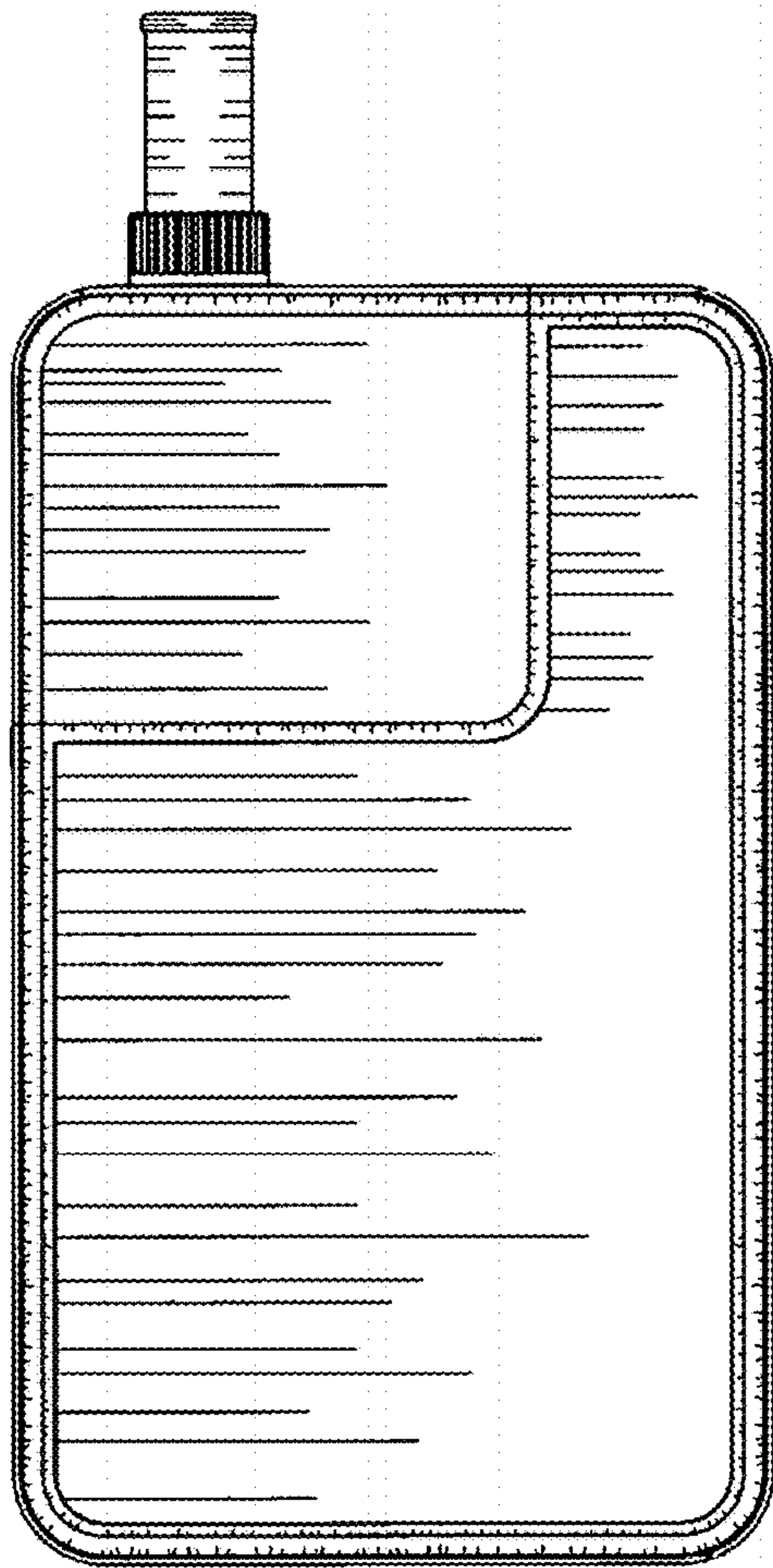

FIG. 3

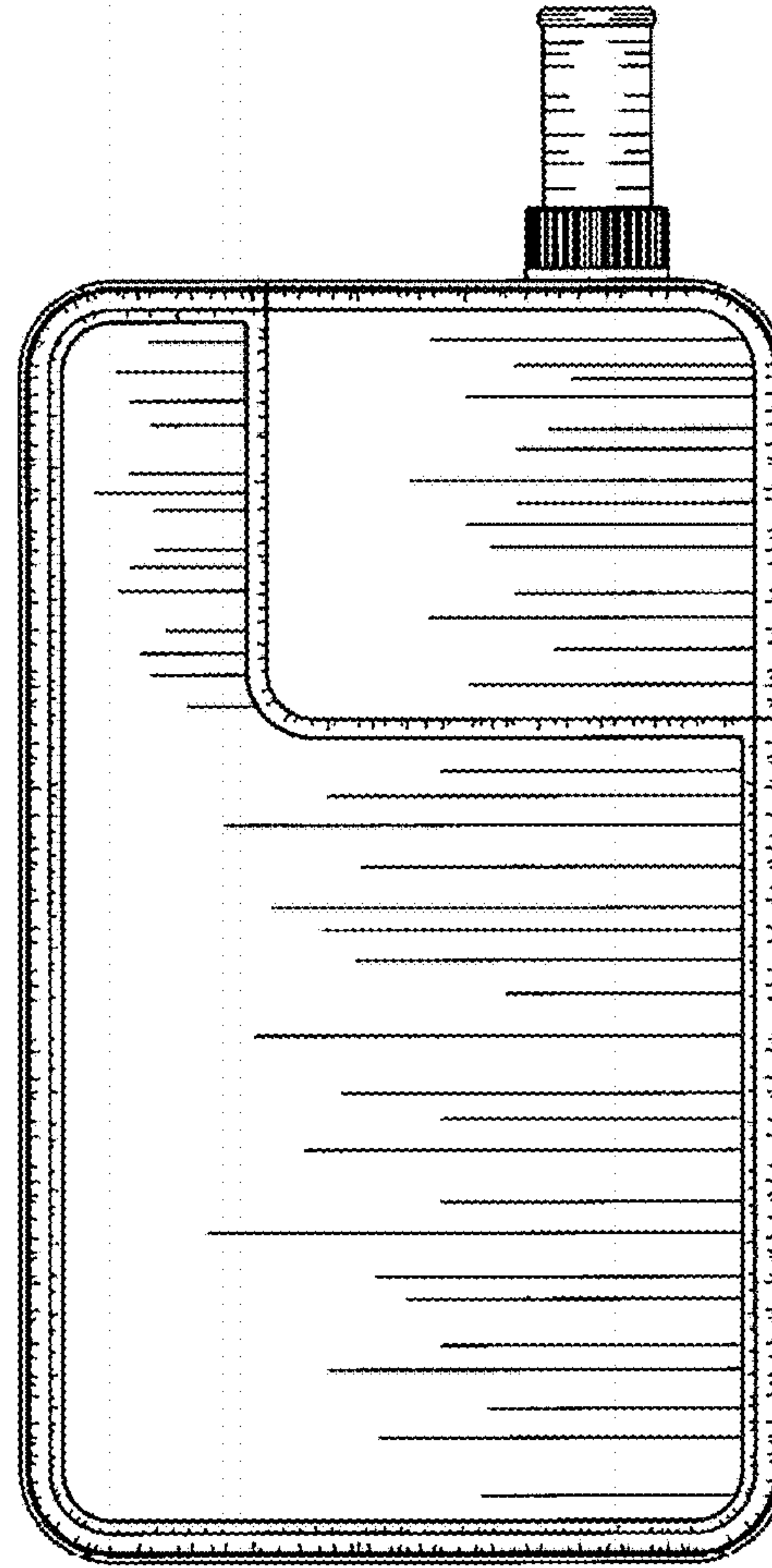

FIG. 4

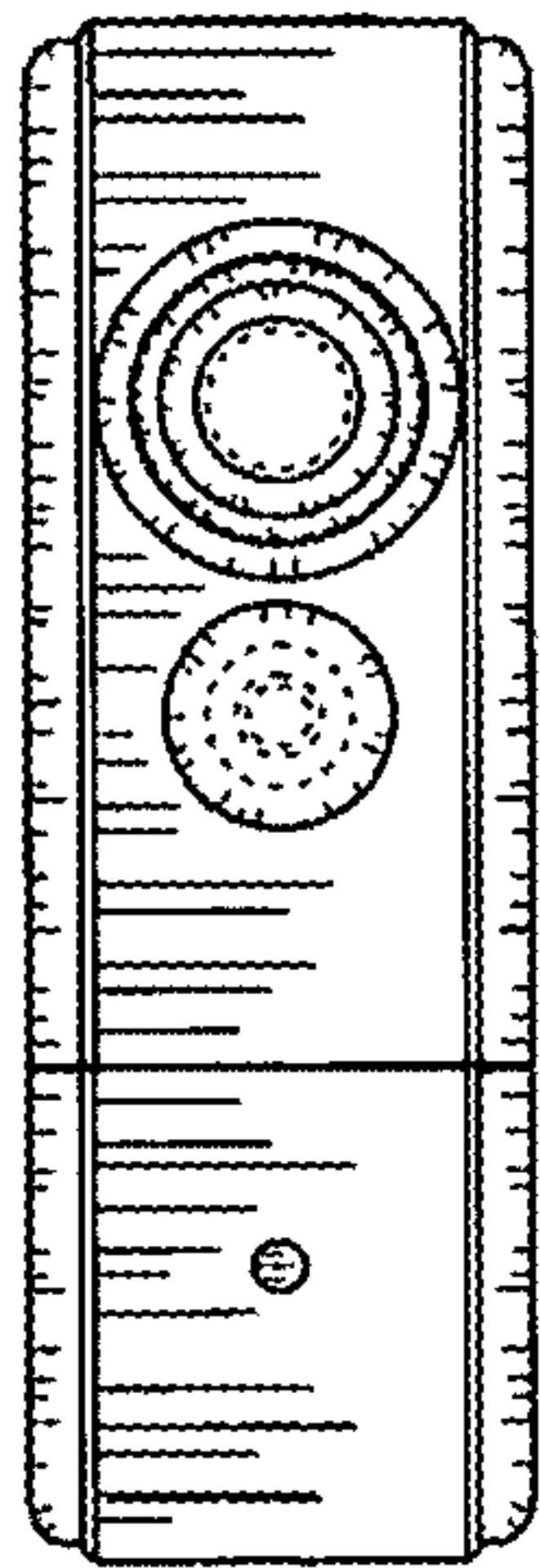

FIG. 5

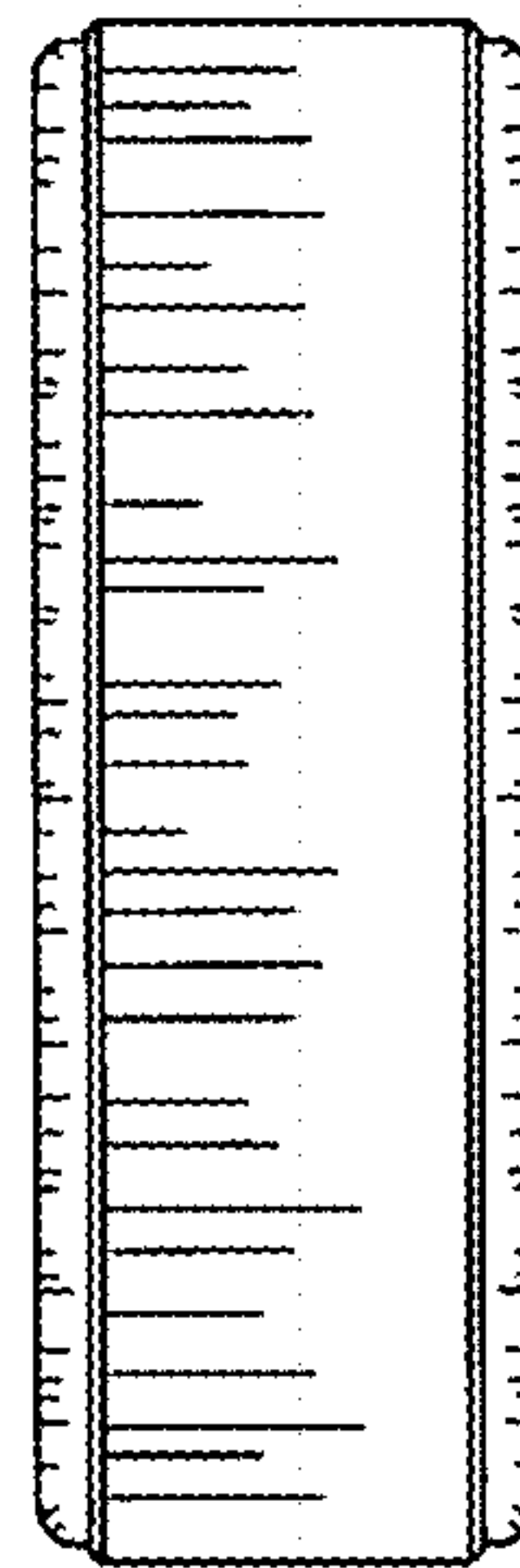

FIG. 6

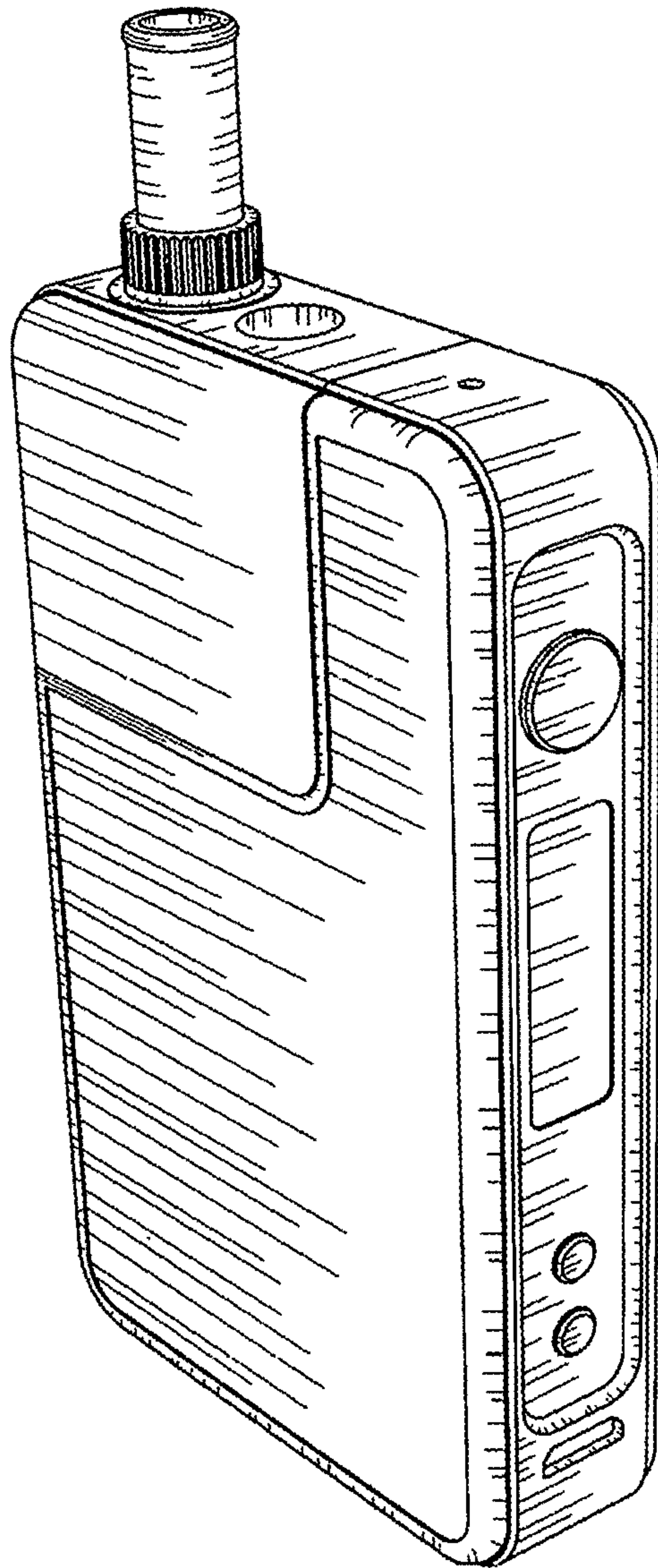

FIG. 7

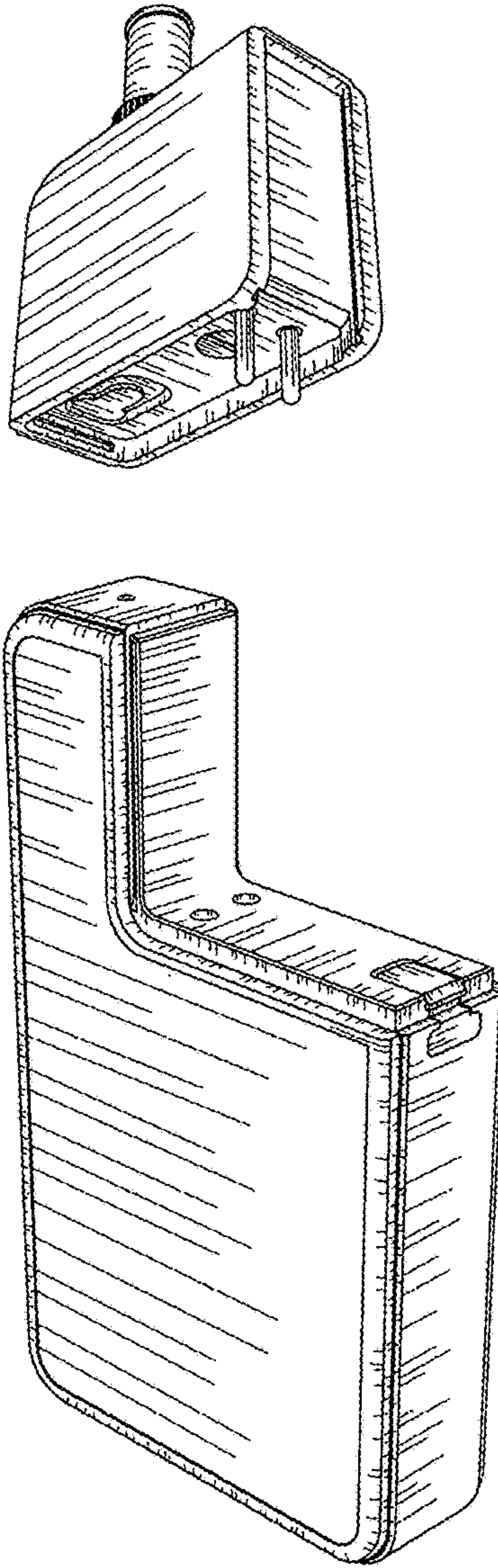

FIG. 8