

US00D790666S

(12) **United States Design Patent** (10) **Patent No.:** **US D790,666 S**
Lord (45) **Date of Patent:** **** Jun. 27, 2017**

(54) **TUB FAUCET**
(71) Applicant: **DELTA FAUCET COMPANY,**
Indianapolis, IN (US)
(72) Inventor: **Judd Lord,** McCordsville, IN (US)
(73) Assignee: **DELTA FAUCET COMPANY,**
Indianapolis, IN (US)
(**) Term: **15 Years**
(21) Appl. No.: **29/550,813**
(22) Filed: **Jan. 7, 2016**
(51) **LOC (10) Cl.** **23-01**
(52) **U.S. Cl.**
USPC **D23/239**
(58) **Field of Classification Search**
USPC D23/238-243, 249-250, 252, 254, 255,
D23/257, 213, 223
CPC E03C 1/04; E03C 1/0401; E03C 1/0402;
E03C 1/0404
See application file for complete search history.

D680,195 S * 4/2013 Lord D23/255
D680,627 S * 4/2013 Lord D23/255
D689,986 S * 9/2013 Lord D23/238

* cited by examiner

Primary Examiner — Robert Delehanty
(74) *Attorney, Agent, or Firm* — Edgar A. Zarins; Nirav D. Parikh

(57) **CLAIM**

The ornamental design for a tub faucet, as shown and described.

DESCRIPTION

FIG. 1 is a perspective view of a tub faucet showing my new design;
FIG. 2 is a front elevational view thereof;
FIG. 3 is a rear view thereof;
FIG. 4 is a right side view thereof;
FIG. 5 is a left side view thereof;
FIG. 6 is a top plan view thereof;
FIG. 7 is a bottom view thereof;
FIG. 8 is a perspective view of an alternative embodiment thereof;
FIG. 9 is a front elevational view thereof;
FIG. 10 is a rear view thereof;
FIG. 11 is a right side view thereof;
FIG. 12 is a left side view thereof;
FIG. 13 is a top plan view thereof; and,
FIG. 14 is a bottom view thereof.

(56) **References Cited**

U.S. PATENT DOCUMENTS

D583,907 S * 12/2008 Citterio D23/238
D615,623 S * 5/2010 Krause D23/239

1 Claim, 6 Drawing Sheets

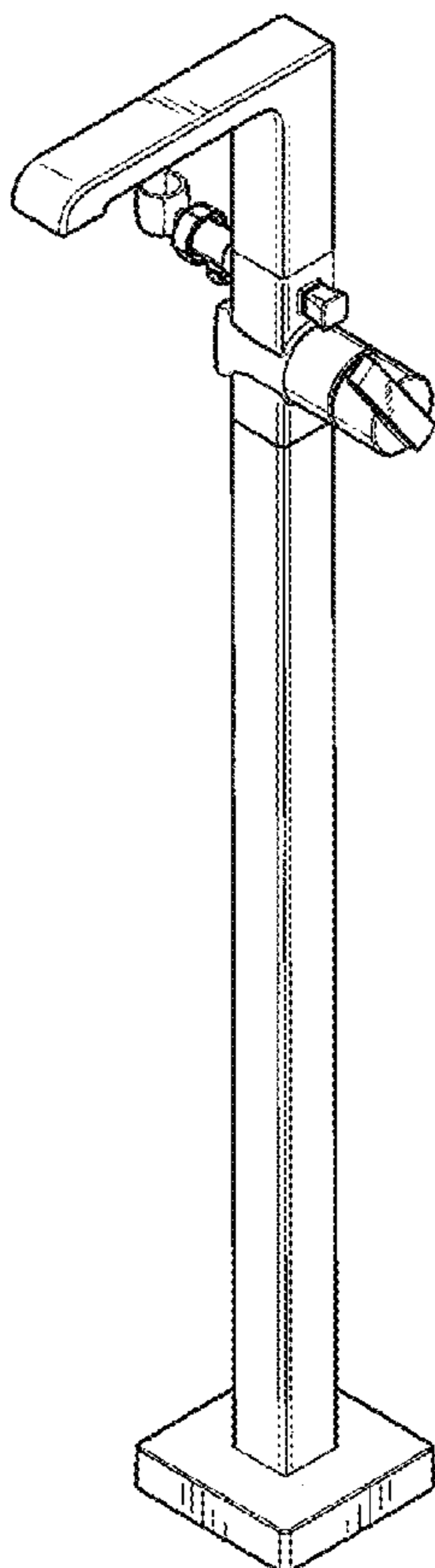

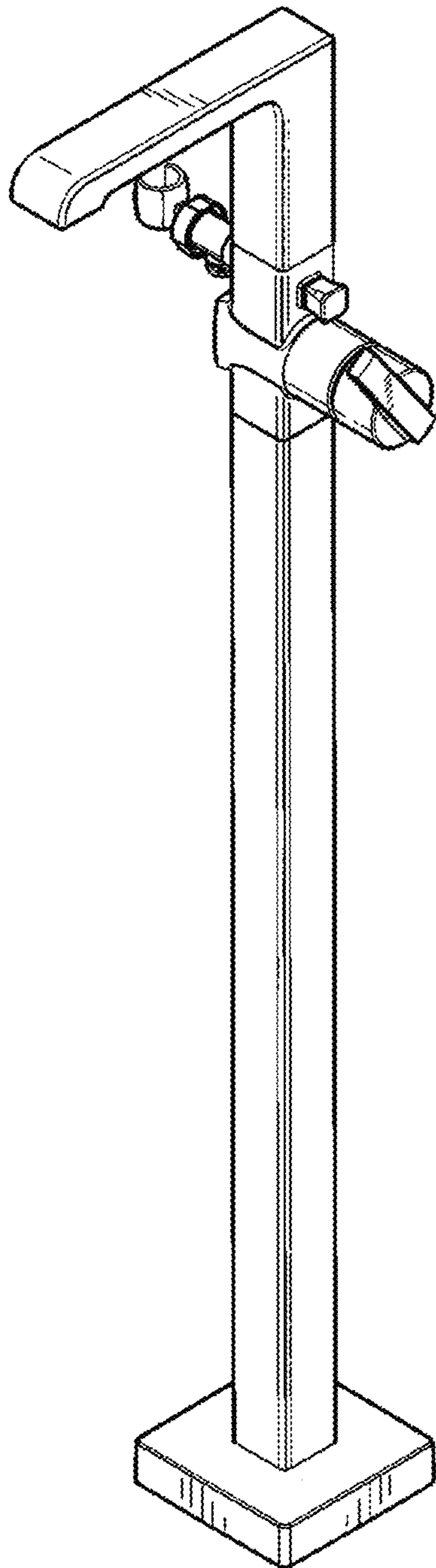

Fig-1

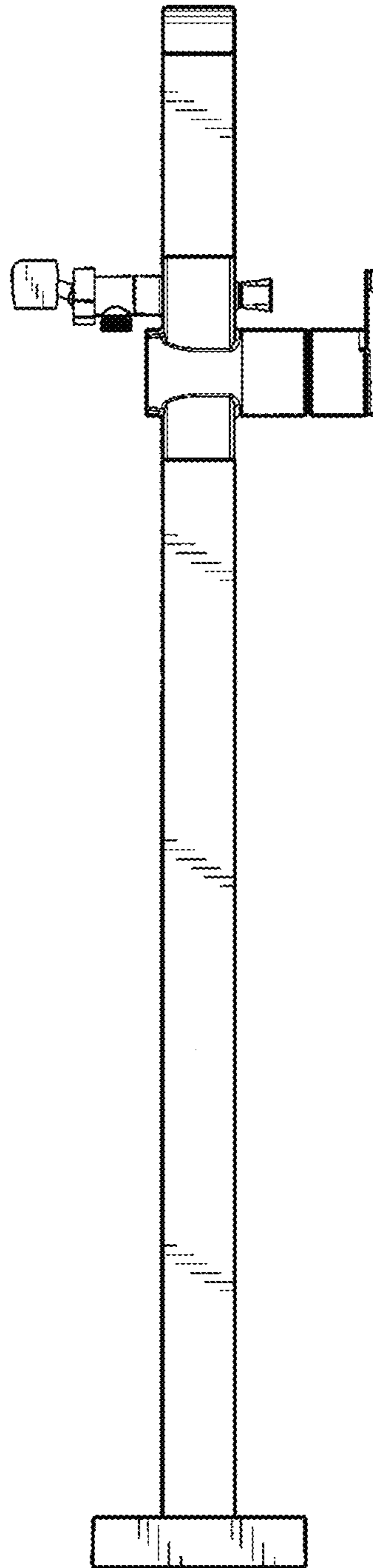

Fig-2

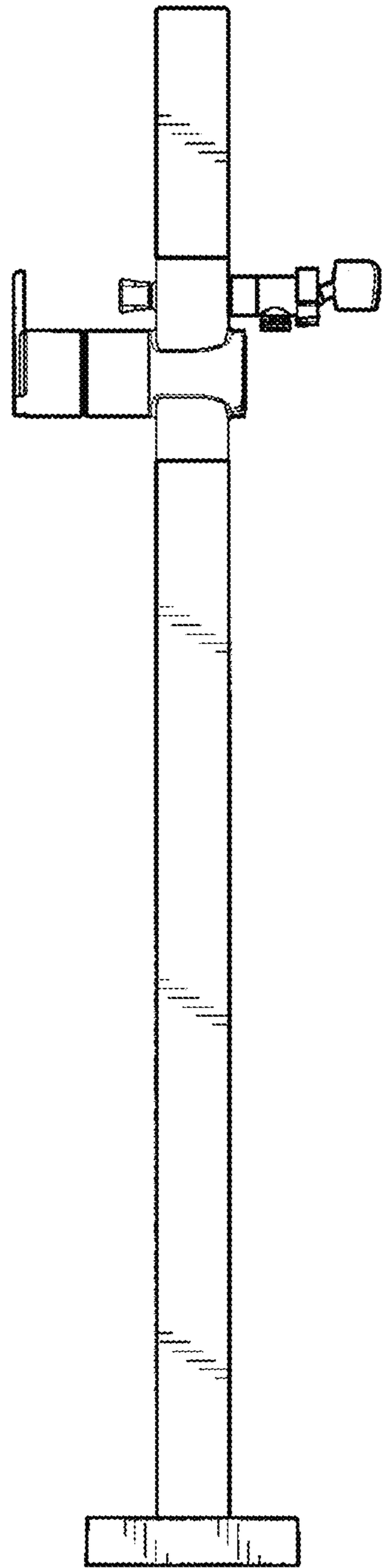

Fig-3

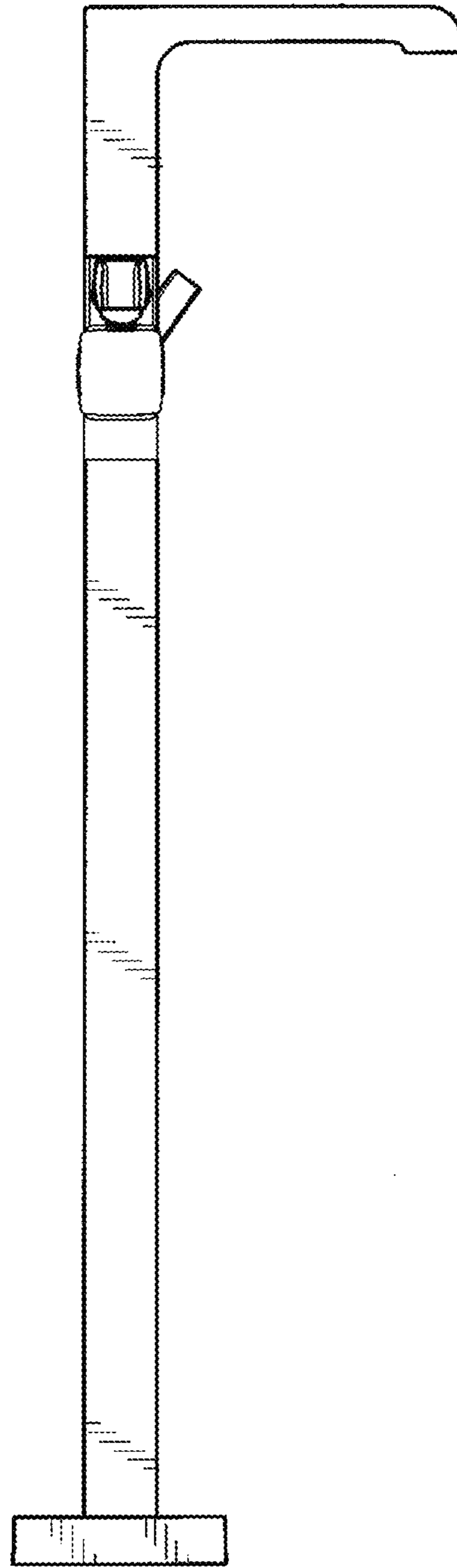

Fig-4

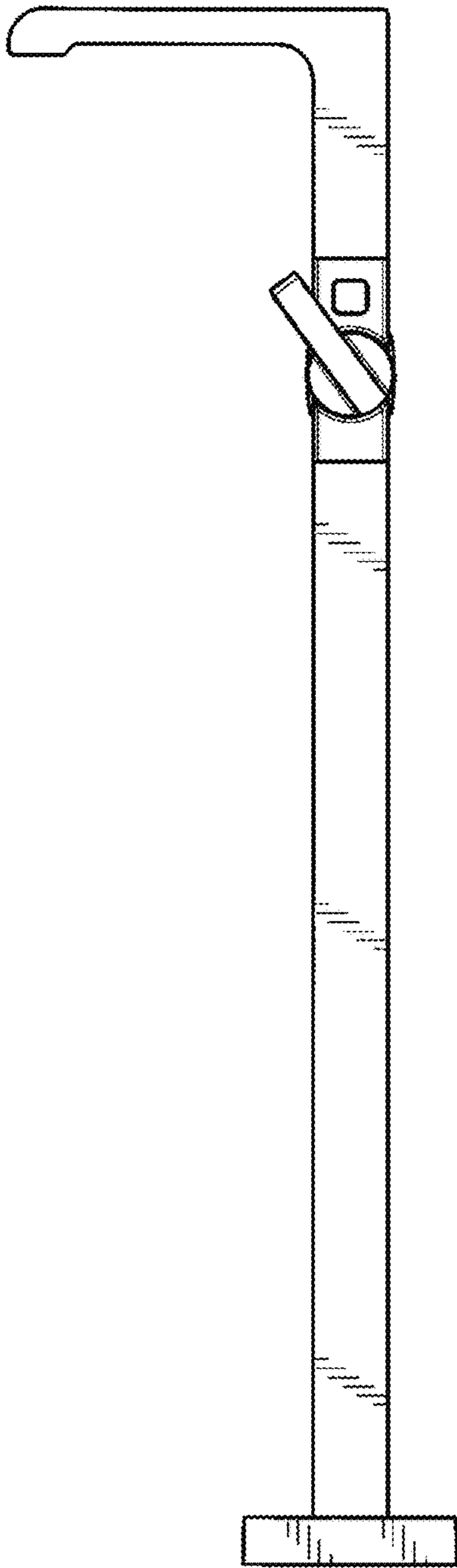

Fig-5

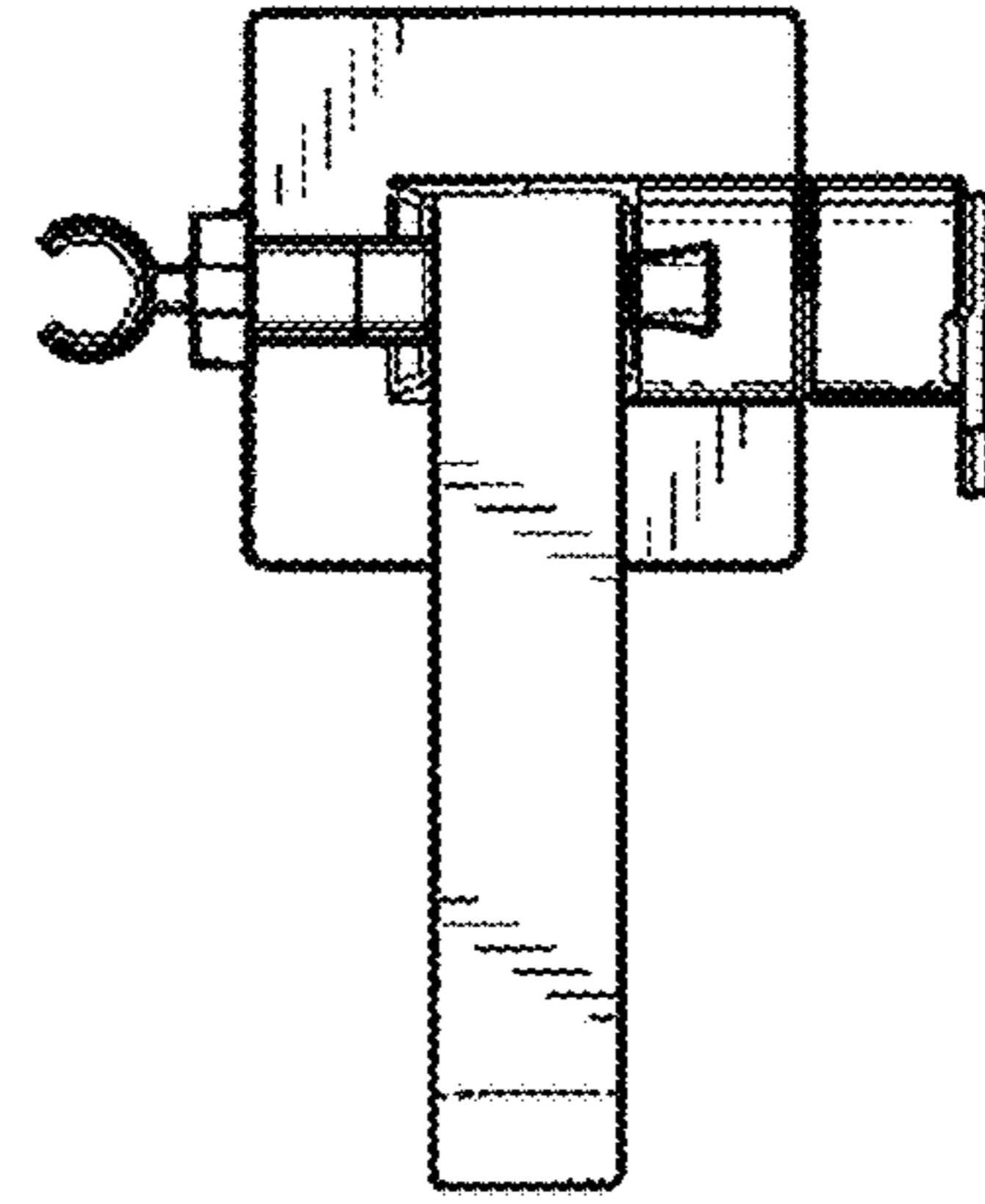

Fig-6

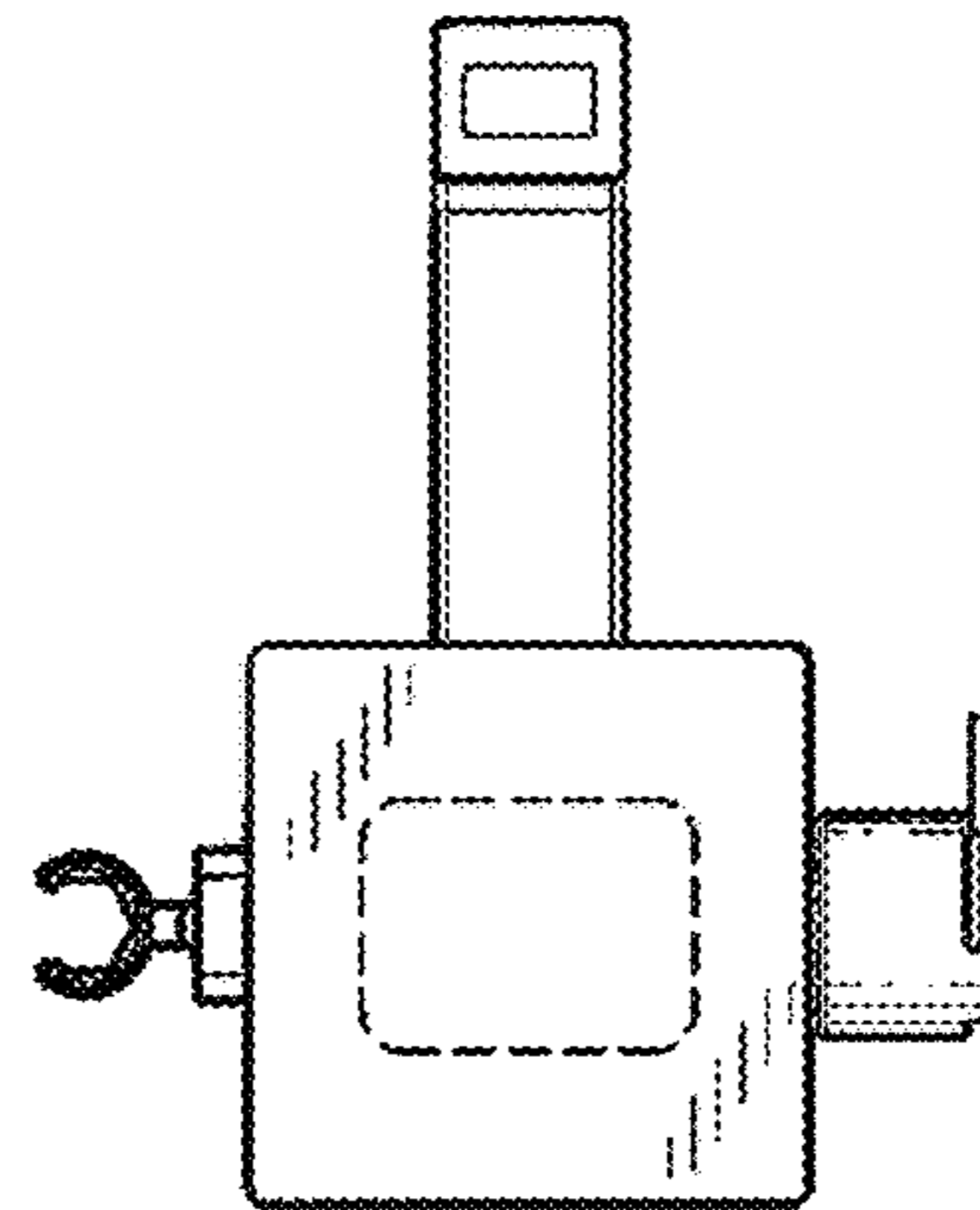

Fig-7

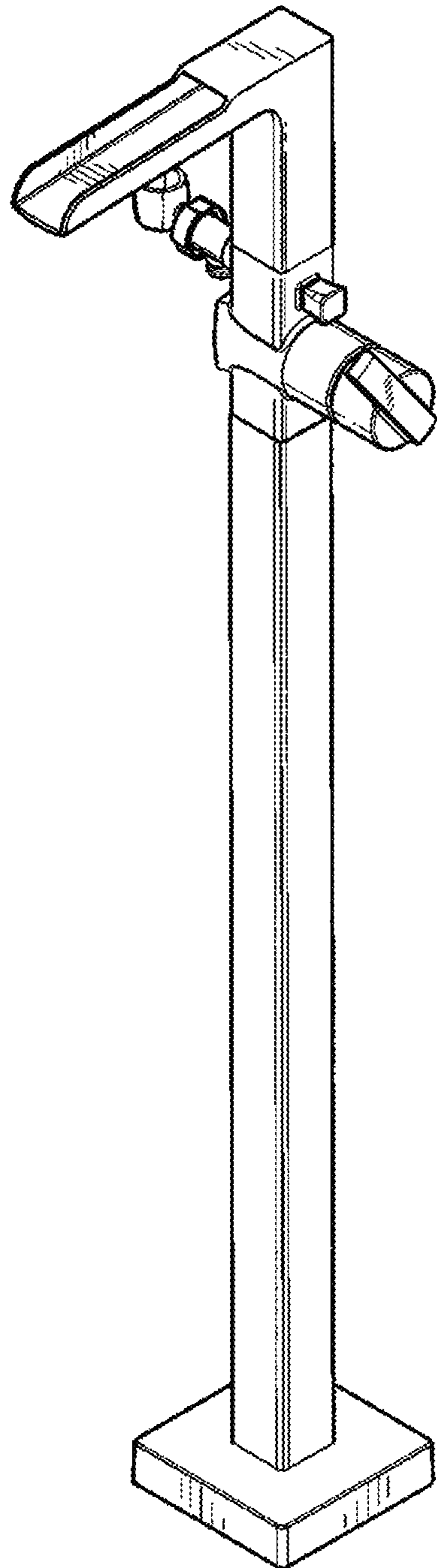

Fig-8

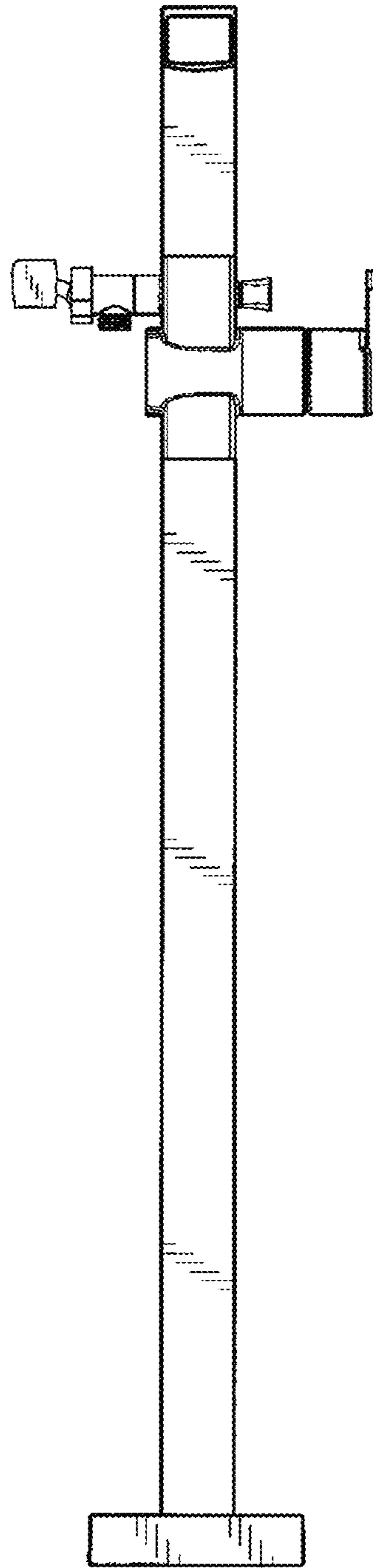

Fig-9

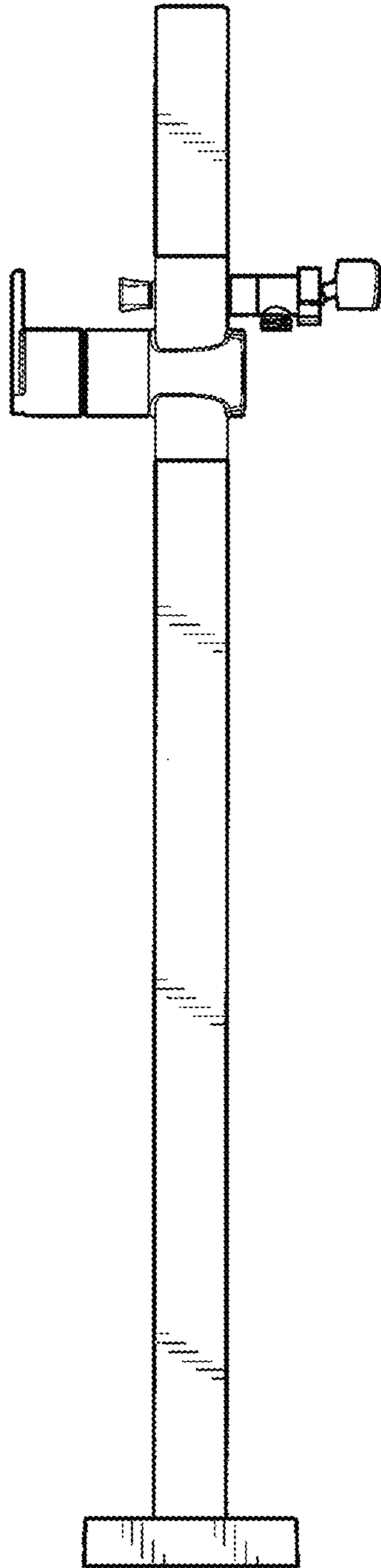

Fig-10

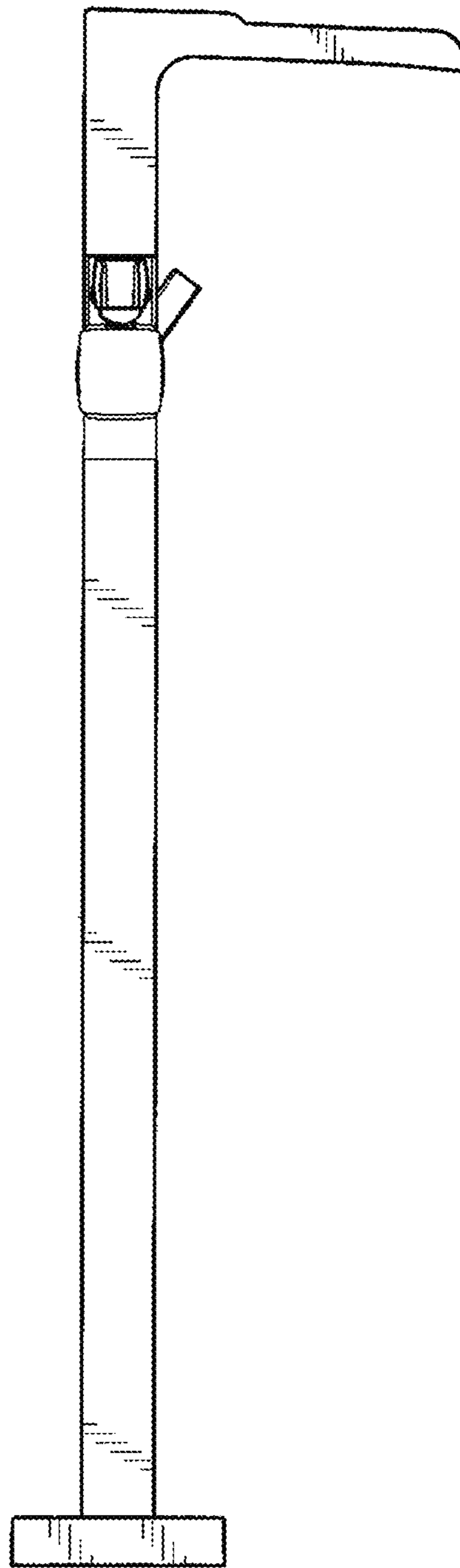

Fig-11

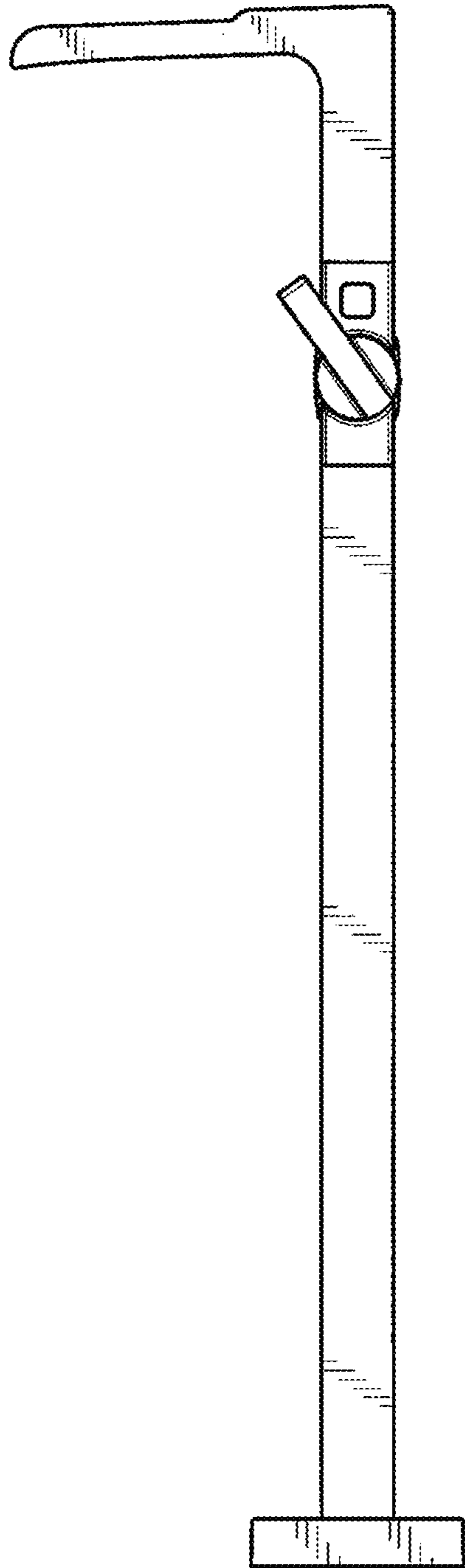

Fig-12

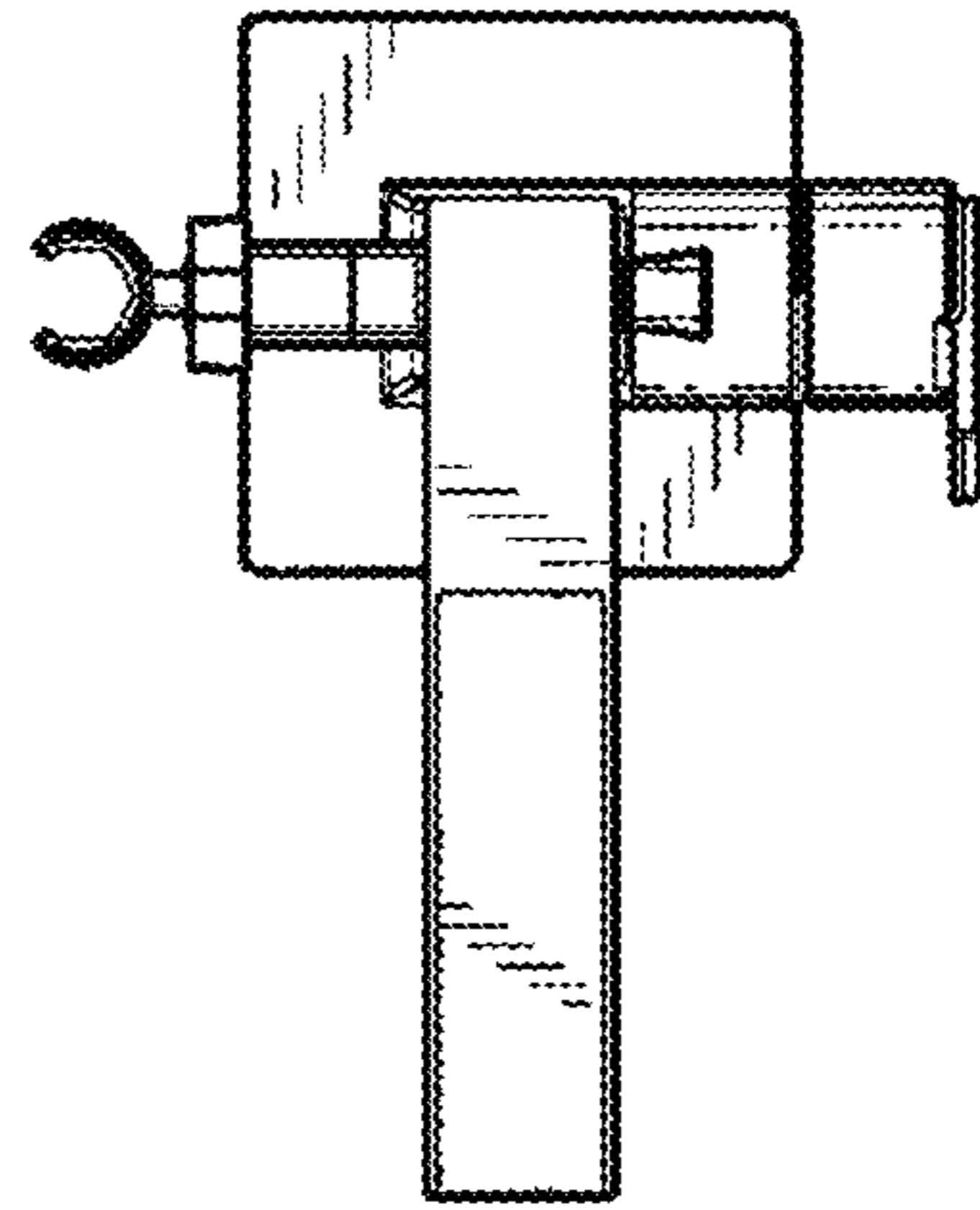

Fig-13

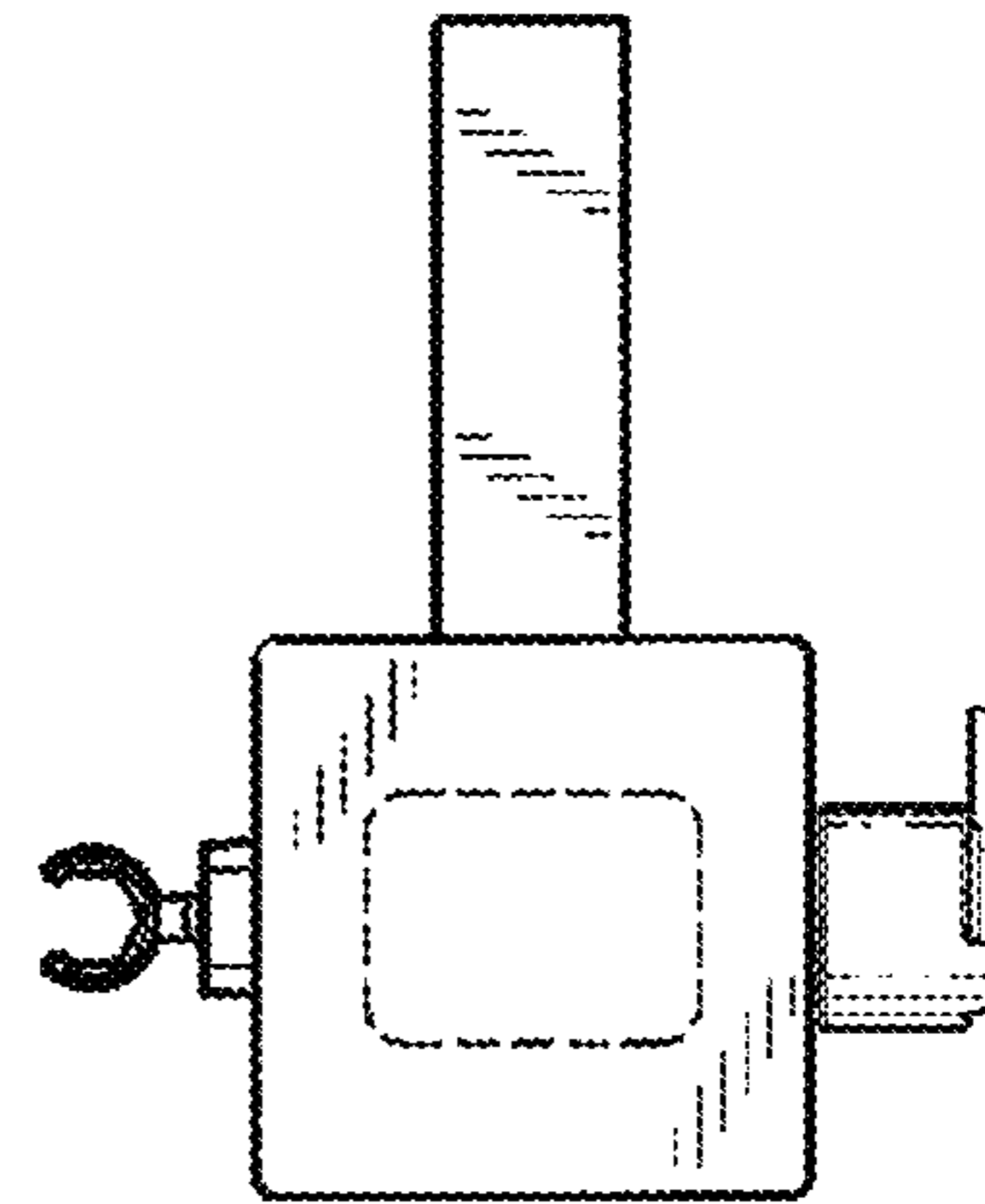

Fig-14