



US00D790514S

(12) **United States Design Patent** (10) **Patent No.:** **US D790,514 S**
Woodward et al. (45) **Date of Patent:** **** Jun. 27, 2017**

- (54) **MARINE RADAR HOUSING**
- (71) Applicant: **FLIR Systems, Inc.**, Wilsonville, OR (US)
- (72) Inventors: **Christopher M. Woodward**, London (GB); **Richard Timothy Moth**, Hampshire (GB)
- (73) Assignee: **FLIR Systems, Inc.**, Wilsonville, OR (US)
- (**) Term: **14 Years**
- (21) Appl. No.: **29/517,945**
- (22) Filed: **Feb. 18, 2015**
- (51) **LOC (10) Cl.** **14-03**
- (52) **U.S. Cl.**
USPC **D14/230; D10/65**
- (58) **Field of Classification Search**
USPC D10/47, 65, 70, 80, 106.1, 106.2, 106.5, D10/140.1, 121; D16/203; 348/143, 148, 348/151, 373-376; D14/230, 299, 358, D14/427, 459-460, 344, 203.5, 238
CPC H01Q 7/00; H01Q 13/10; H01Q 9/285; H01Q 3/44; H01Q 19/30; H01Q 19/12; H01Q 1/38; H01Q 1/243; H01Q 1/273; H01Q 1/3275; H01Q 1/1271; H01Q 1/125
See application file for complete search history.

- (56) **References Cited**
U.S. PATENT DOCUMENTS
D247,665 S * 4/1978 Larsen D10/106.1
D260,975 S * 9/1981 Lam D10/106.5
D288,560 S * 3/1987 Anderson D14/212
D317,132 S * 5/1991 Knipfer D10/65
D346,598 S * 5/1994 McCay D14/137
D380,401 S * 7/1997 Sarkis D10/106.1
D387,771 S * 12/1997 Martinson D14/230
D401,592 S 11/1998 Nishimura et al.
D401,594 S * 11/1998 Nishimura D14/230
D414,476 S * 9/1999 Hibino D13/101

- D424,465 S * 5/2000 Davidson D10/106.1
- D434,686 S * 12/2000 Denman D10/106.1
- D577,301 S * 9/2008 Johnson D10/106.1
- D581,927 S * 12/2008 Sumii D14/356
- D602,915 S * 10/2009 Song D14/218
- D666,175 S * 8/2012 Yamada D14/218
- D686,929 S * 7/2013 Rainer D10/81
- D692,332 S * 10/2013 Ni D10/106.1
- D717,674 S * 11/2014 Vu D10/65
- D751,534 S 3/2016 Lenz et al.
- 2015/0023517 A1* 1/2015 Mizrahi H04B 1/034 381/74

OTHER PUBLICATIONS

JMA-2353 Marine Radar Brochure.bluewave.co.id/[online]. Oct. 19, 2013 [retrieved on Jul. 21, 2016]. Retrieved from the Internet: <http://bluewave.co.id/wp-content/uploads/2013/12/JMA-2300-brochure.pdf>.*

* cited by examiner

Primary Examiner — Philip S Hyder
Assistant Examiner — Ramzi Almatrahi
(74) *Attorney, Agent, or Firm* — Haynes and Boone, LLP

(57) **CLAIM**

The ornamental design for a marine radar housing, as shown and described.

DESCRIPTION

FIG. 1 is a top-front-right perspective view of a marine radar housing embodying the new design; FIG. 2 is a front elevational view thereof; FIG. 3 is a rear elevational view thereof; FIG. 4 is a top plan view thereof; FIG. 5 is a bottom plan view thereof; FIG. 6 is a right side elevational view thereof; and, FIG. 7 is a left side elevational view thereof. The broken lines depict portions of a marine radar housing in which the design is embodied that form no part of the claimed design.

1 Claim, 7 Drawing Sheets

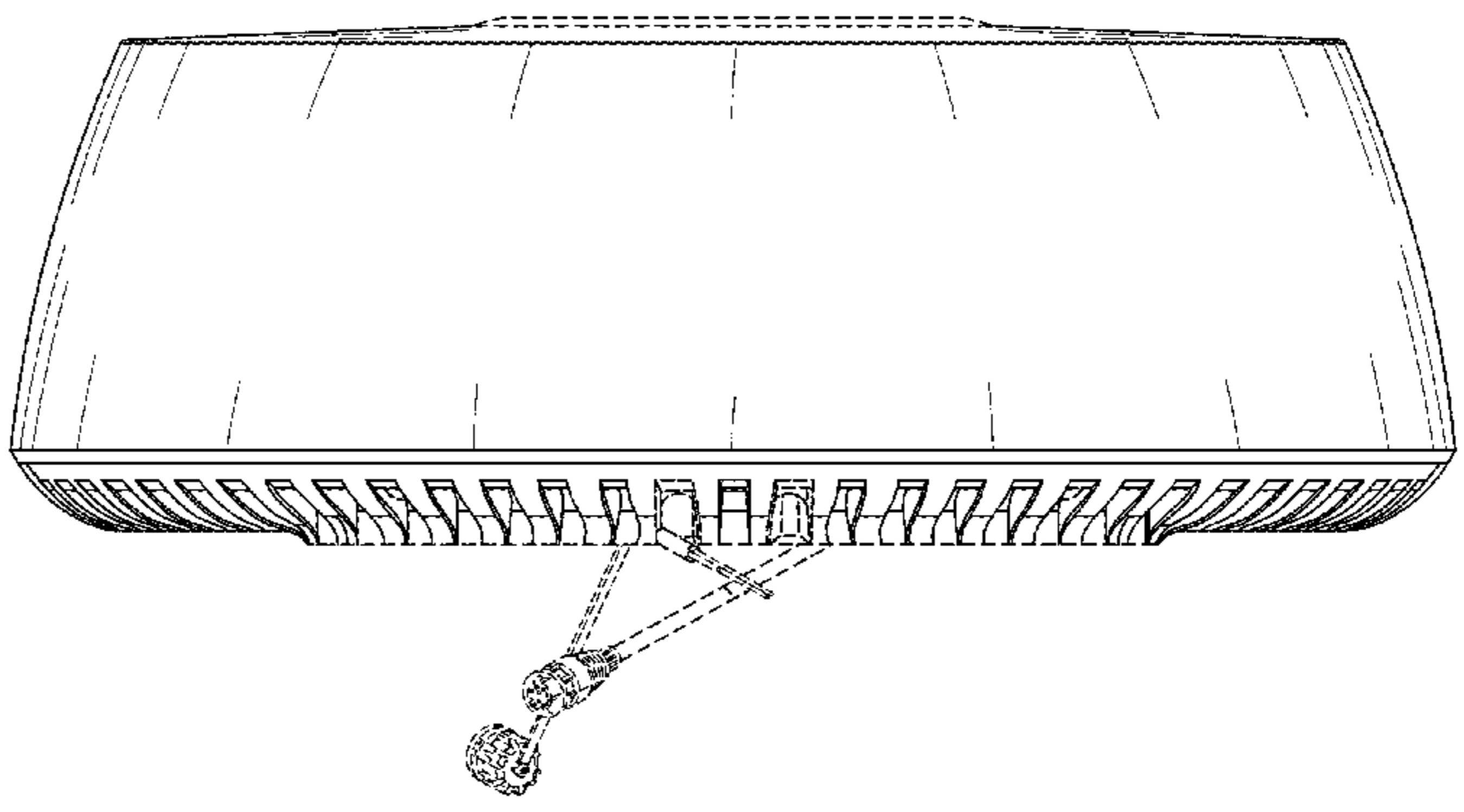
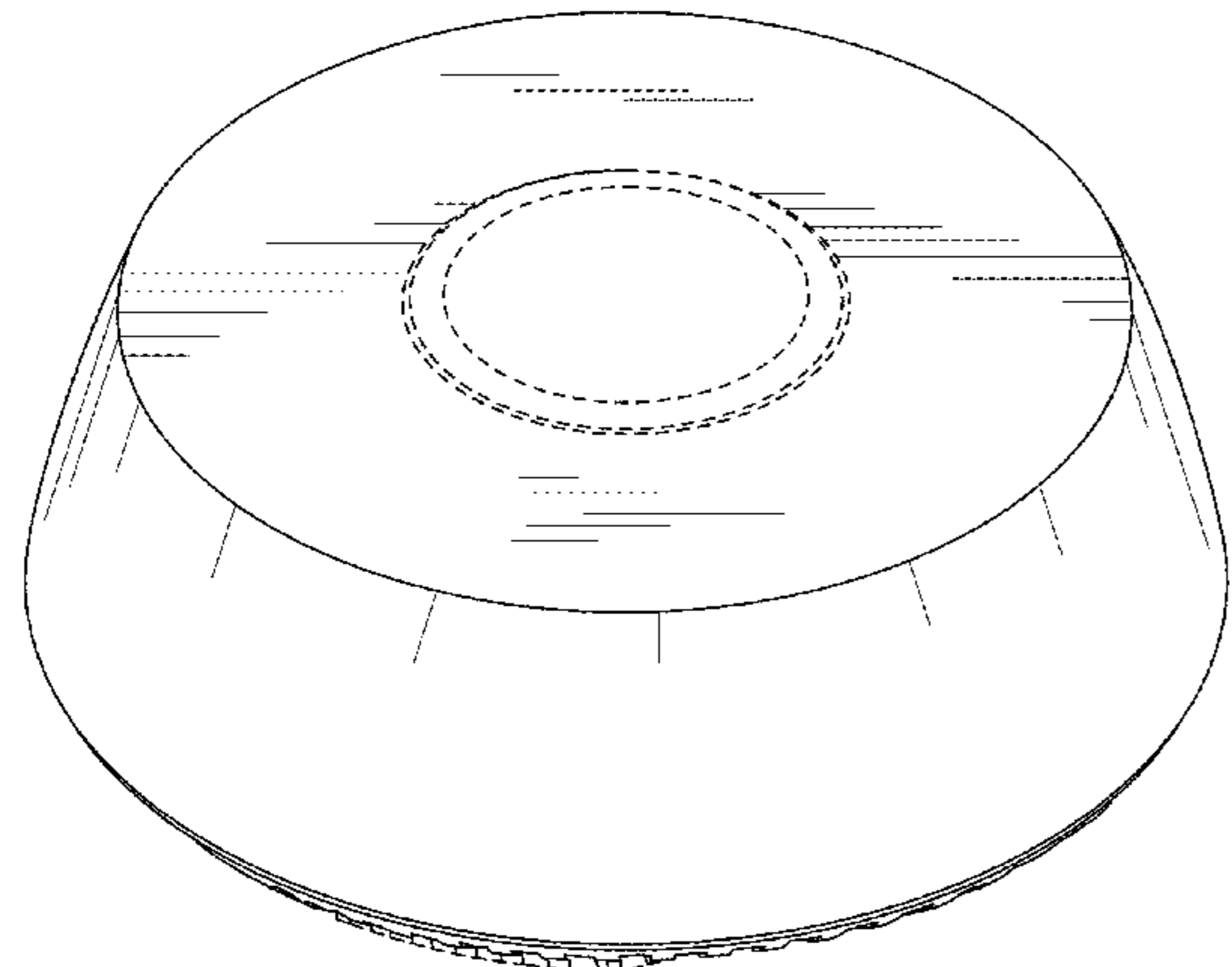

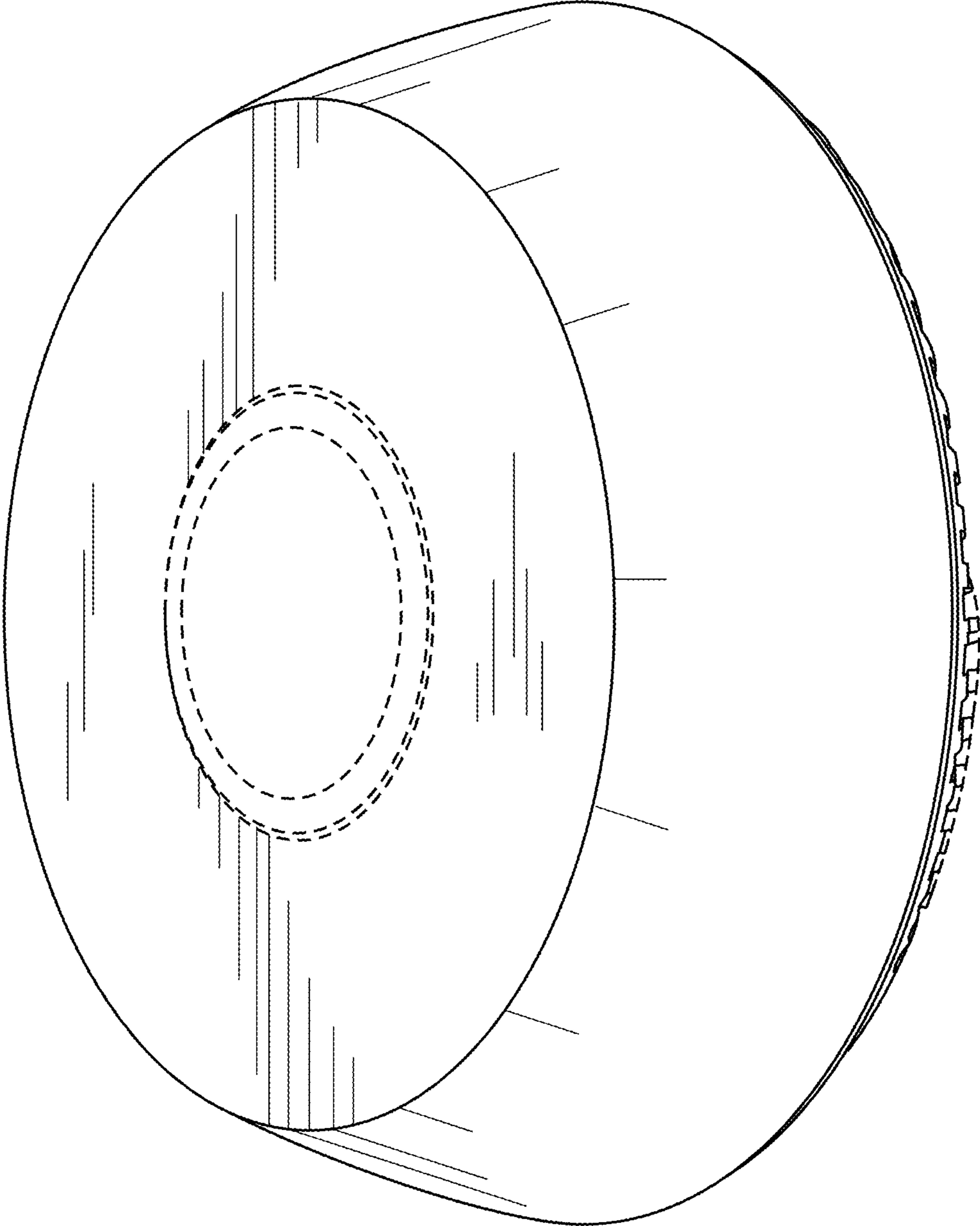

FIG. 1

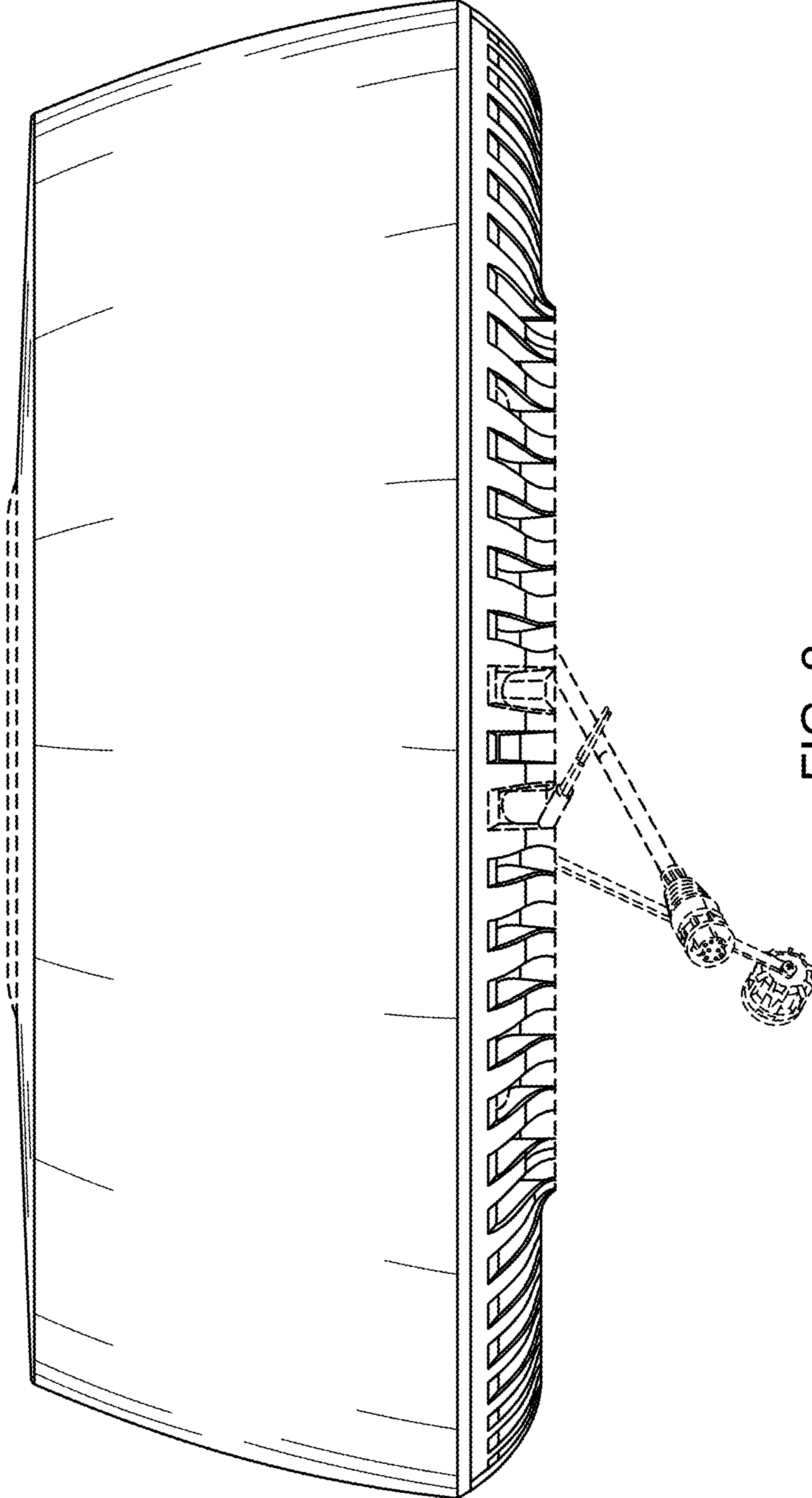

FIG. 2

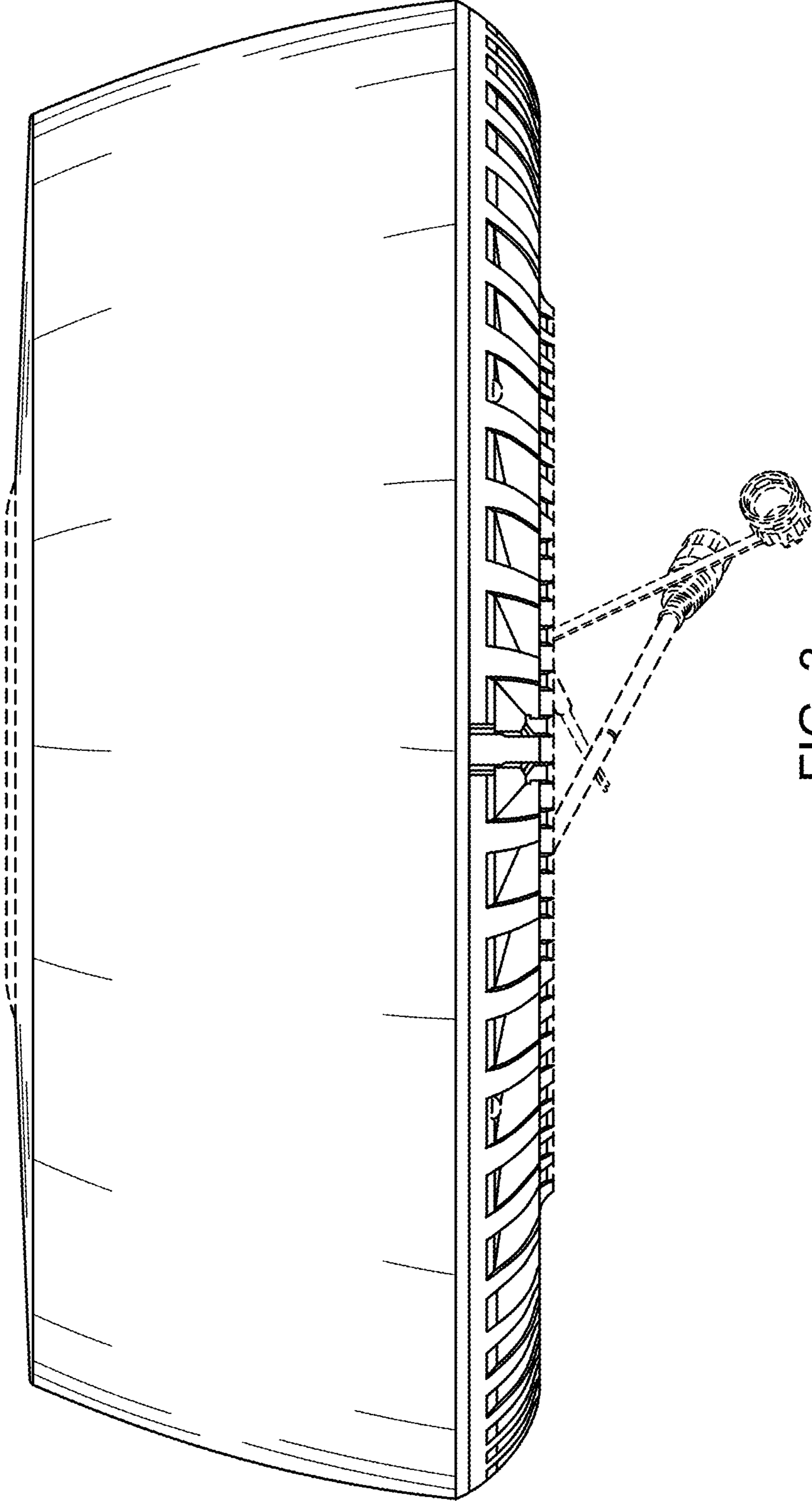

FIG. 3

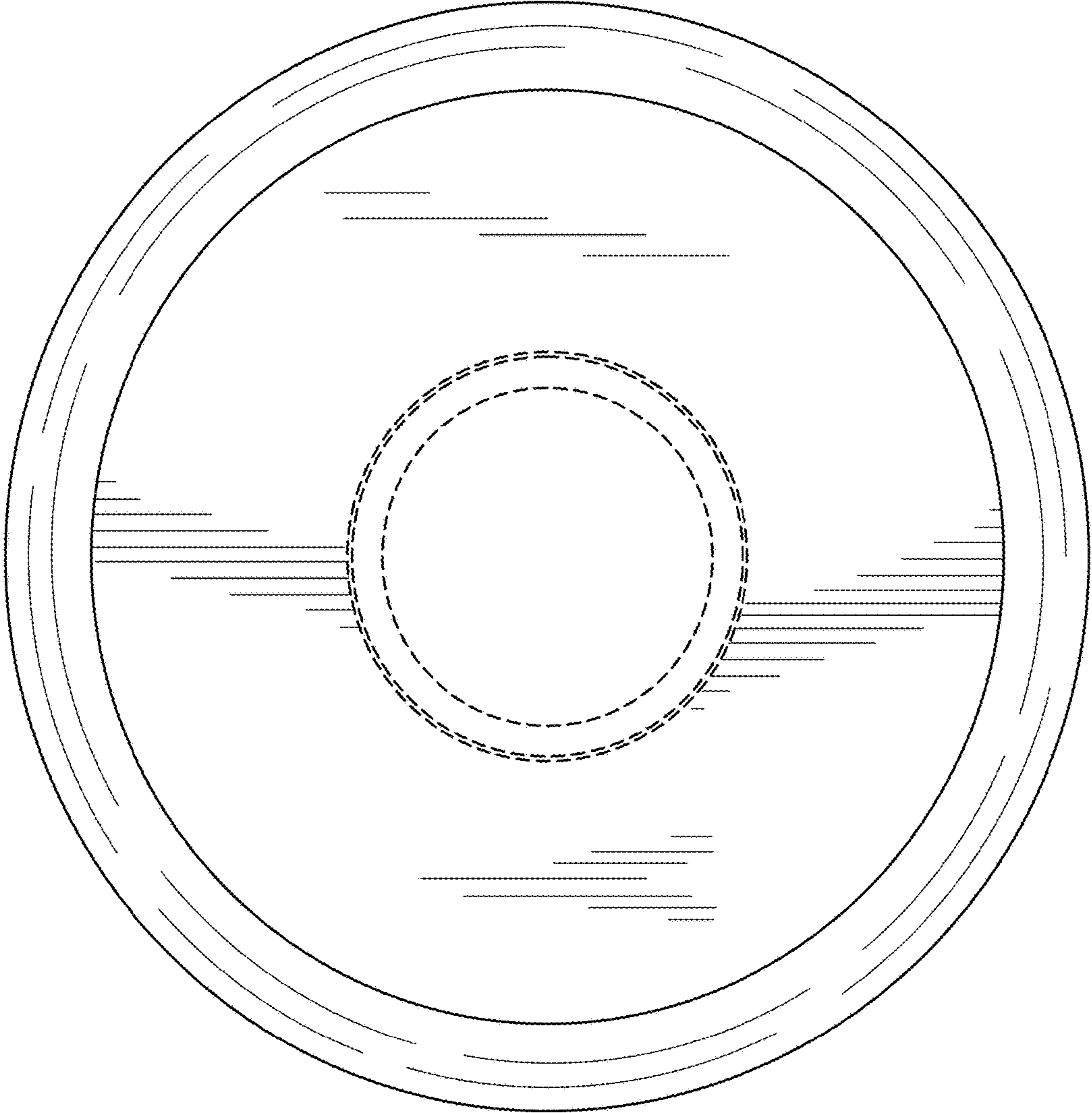

FIG. 4

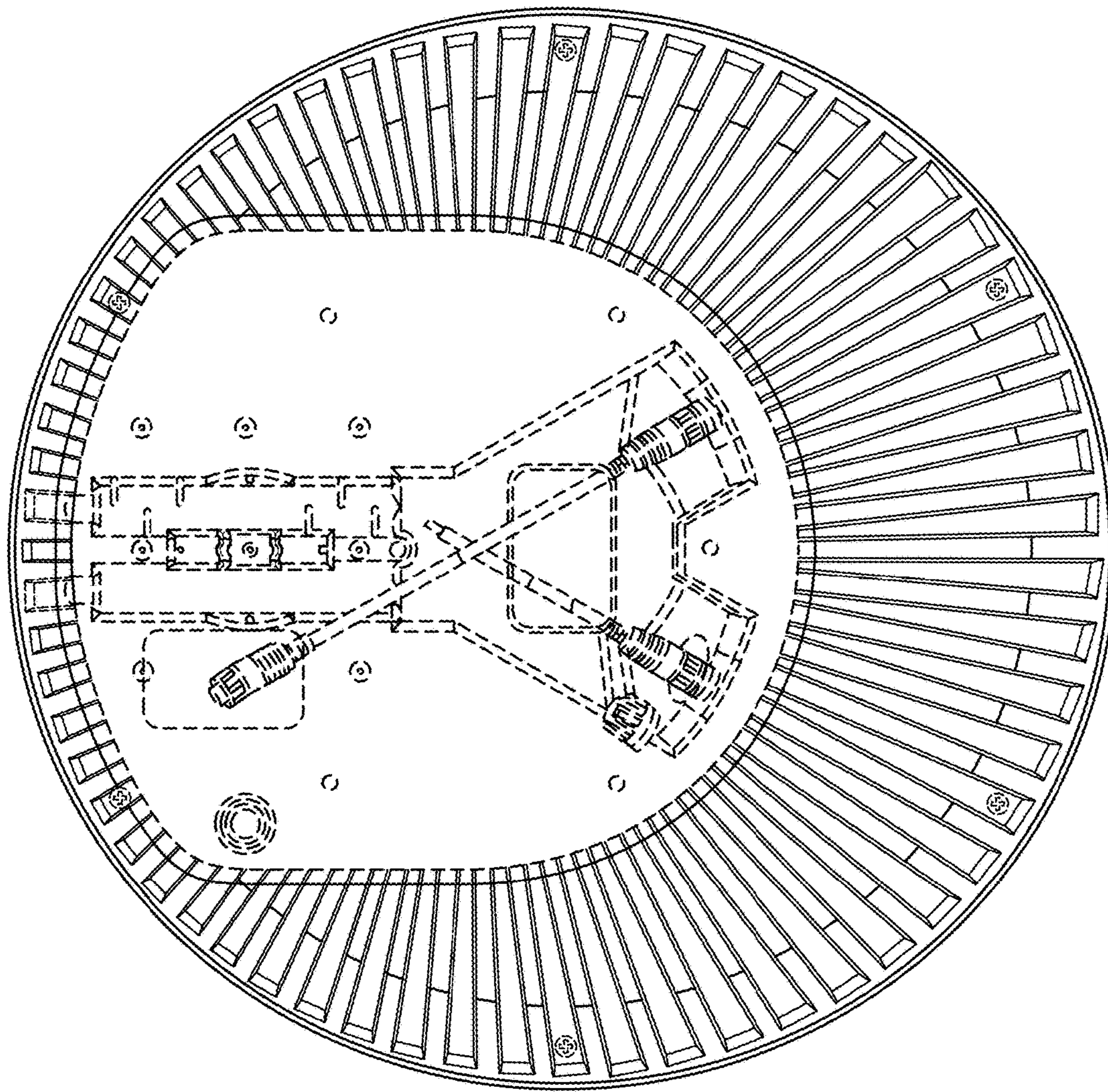

FIG. 5

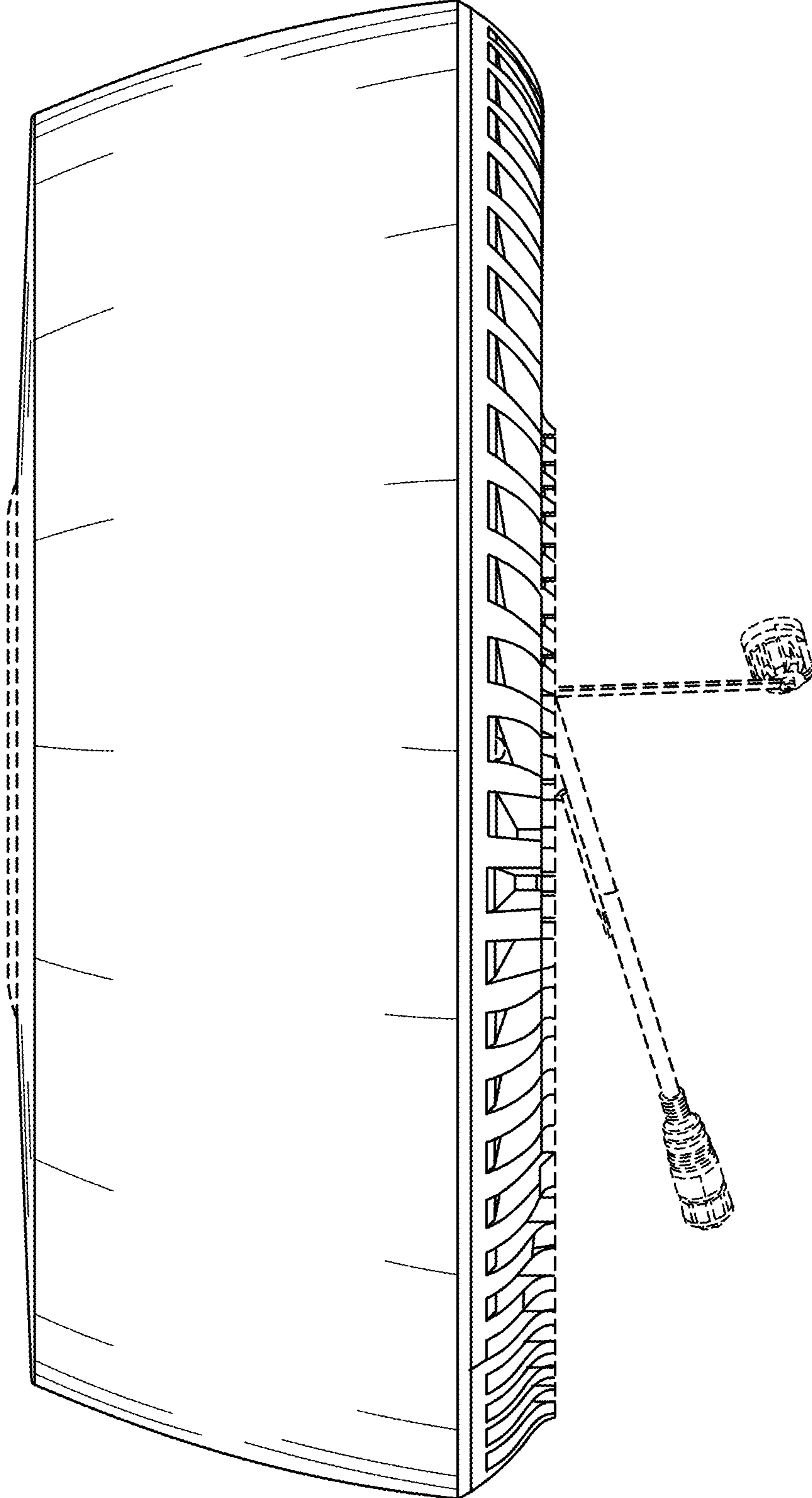

FIG. 6

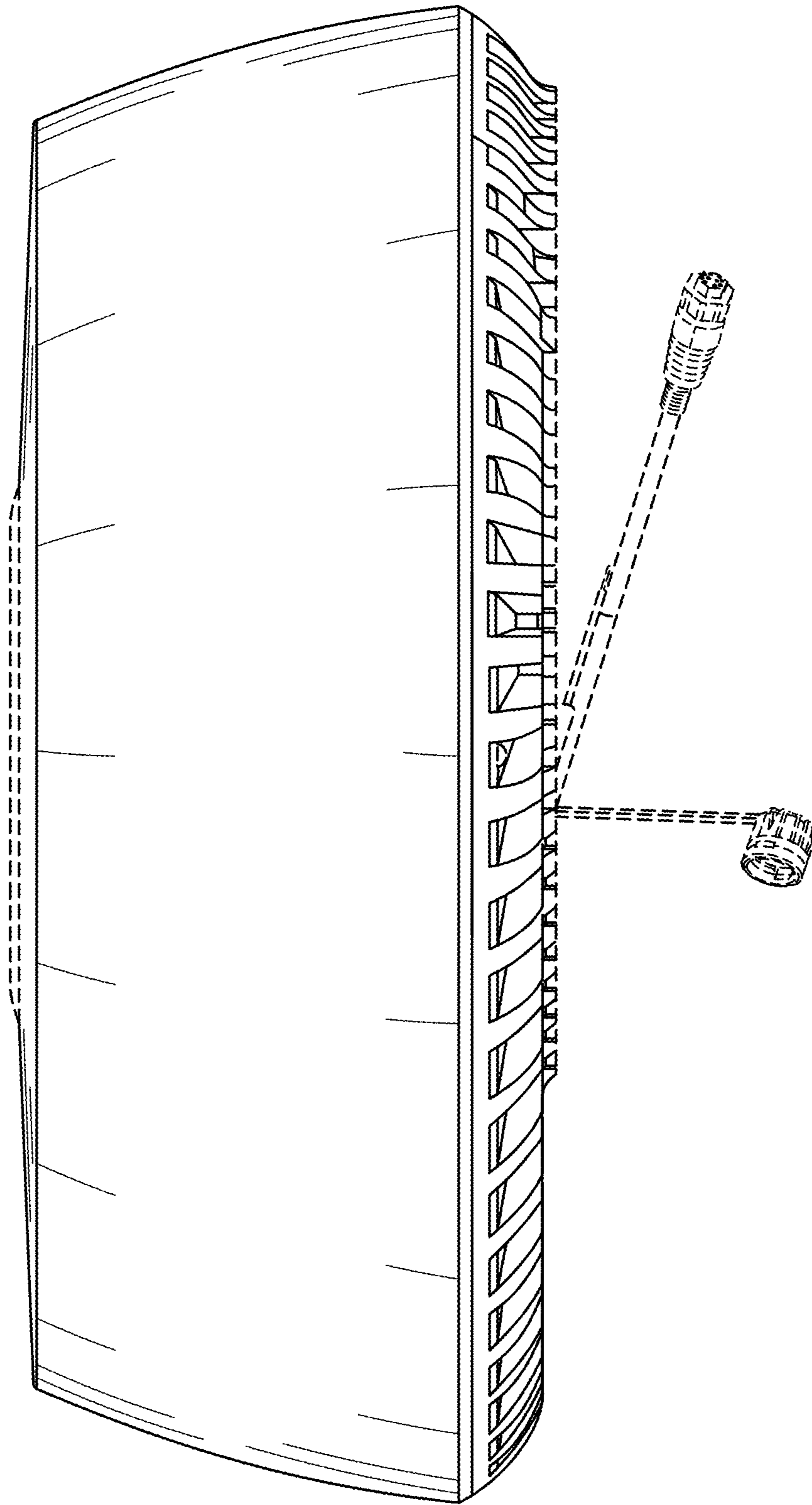

FIG. 7