

US00D790382S

(12) **United States Design Patent** (10) **Patent No.:** **US D790,382 S**
Sasson (45) **Date of Patent:** **** Jun. 27, 2017**

(54) **WATCH BAND**
(71) Applicant: **Accutime Watch Corp.**, New York, NY (US)
(72) Inventor: **Israel M. Sasson**, New York, NY (US)
(73) Assignee: **ACCUTIME WATCH CORP.**, New York, NY (US)

6,269,991 B1 * 8/2001 Hood A45C 13/30
224/258
D462,710 S * 9/2002 Babcock D17/20
D473,034 S * 4/2003 Styne D2/624
D495,853 S * 9/2004 Nelson D2/627
D513,034 S * 12/2005 Boron D17/20
D542,523 S 5/2007 Labelson
D544,707 S 6/2007 Labelson

(Continued)

(**) Term: **15 Years**

(21) Appl. No.: **29/554,302**

(22) Filed: **Feb. 10, 2016**

(51) **LOC (10) Cl.** **11-01**

(52) **U.S. Cl.**
USPC **D11/3**

(58) **Field of Classification Search**
USPC D10/30-32, 38, 39, 46, 70, 128;
D11/1-25, 200, 204, 214-218; D14/344;
D24/167, 184
CPC A44C 5/00; A44C 5/12; A44C 5/14; A44C
5/18; A44C 5/147; A44C 5/185; A44C
5/2047; A44C 5/2052; A44C 5/0007;
A44C 5/003; A44C 5/0015; A44C
5/0023; A44C 5/0053; A44C 5/0061;
A44C 5/0069; A44C 5/0076; A44B
11/24; A44B 11/006

See application file for complete search history.

(56) **References Cited**

U.S. PATENT DOCUMENTS

3,449,800 A * 6/1969 Fisher A44B 11/2511
24/637
4,377,888 A * 3/1983 Ikesue A44B 11/2511
24/637
4,706,992 A * 11/1987 Downing A44B 11/06
24/193
D322,160 S * 12/1991 Dauterive D2/627
D353,932 S * 1/1995 New D11/216
D393,337 S * 4/1998 Seki D2/624

OTHER PUBLICATIONS

Batman analog seat belt strap watch (available online) Retrieved from the internet Dec. 28, 2016, retrieved from the internet URL: http://www.imgur.net/media/1240245772342697993_31102727.*

(Continued)

Primary Examiner — Cathron Brooks

Assistant Examiner — Richard Kearney

(74) *Attorney, Agent, or Firm* — Gottlieb, Rackman & Reisman, PC

(57) **CLAIM**

The ornamental design for a watch band, as shown and described.

DESCRIPTION

FIG. 1 is a top perspective view of a watch showing my new design;

FIG. 2 is a top plan view thereof;

FIG. 3 is a bottom plan view thereof;

FIG. 4 is a rear elevation view thereof;

FIG. 5 is a front elevation view thereof;

FIG. 6 is a left side elevation view thereof; and,

FIG. 7 is a right side elevation view thereof.

The broken lines shown in the drawings illustrate portions of the watch band that form no part of the claimed design. The watch face illustrated in broken lines between the bands is environmental structure and forms no part of the claimed design.

1 Claim, 3 Drawing Sheets

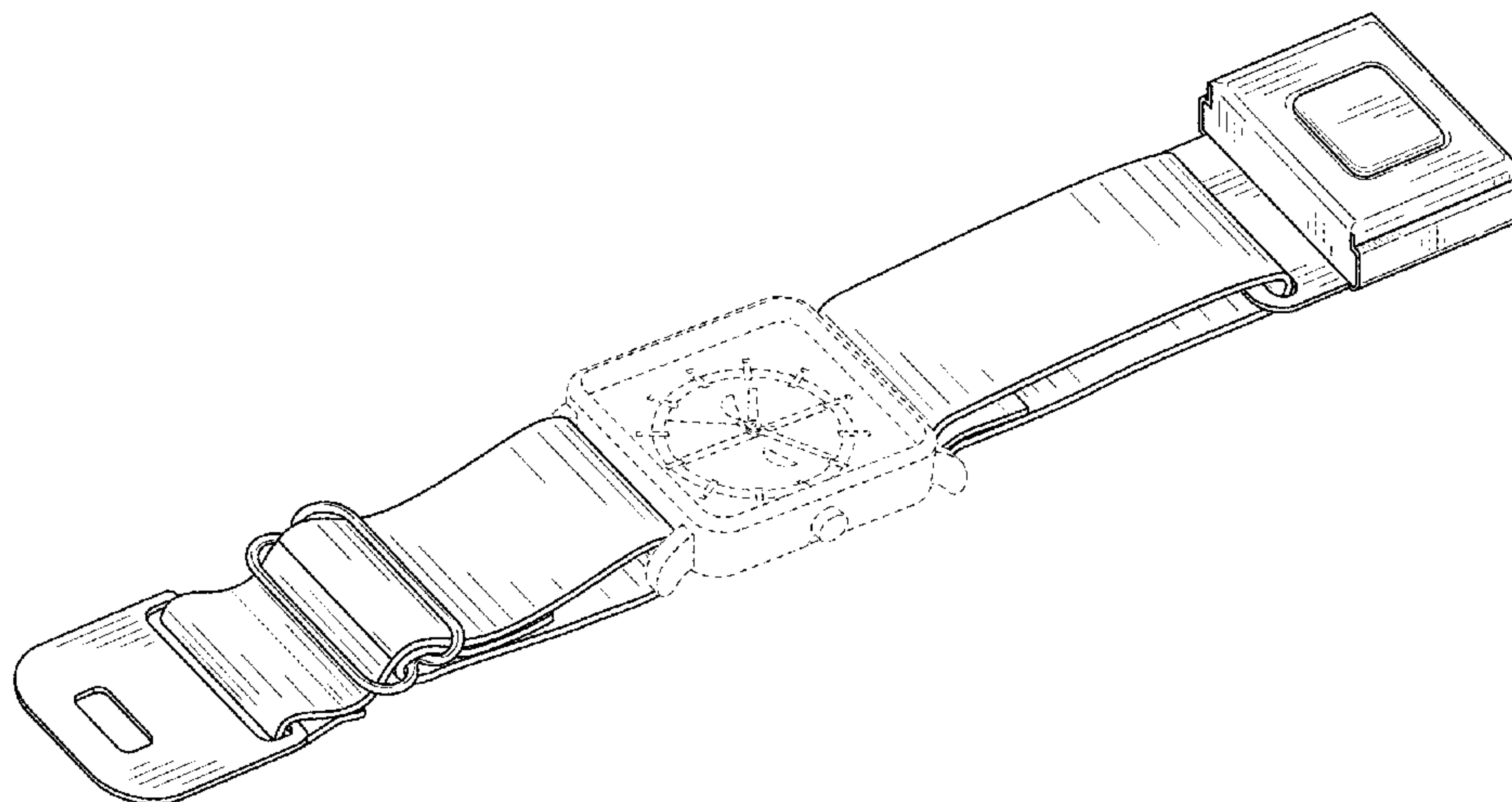

(56)

References Cited

U.S. PATENT DOCUMENTS

D547,053 S 7/2007 Labelson
D609,408 S 2/2010 Labelson et al.
D609,409 S 2/2010 Labelson et al.
D609,410 S 2/2010 Labelson et al.
7,797,803 B2 9/2010 Falb et al.
8,365,364 B2 2/2013 Labelson et al.
D729,652 S * 5/2015 Nuovo D10/32
D769,740 S * 10/2016 Legros D10/32

OTHER PUBLICATIONS

Airline Seat Belt Uhr Watch (available online Aug. 28, 2014)
Retrieved from the internet Jan. 4, 2017, retrieved from the internet
URL:https://web.archive.org/web/20141028091204/http://www.offwhitedesign.com/products-innovation.*

* cited by examiner

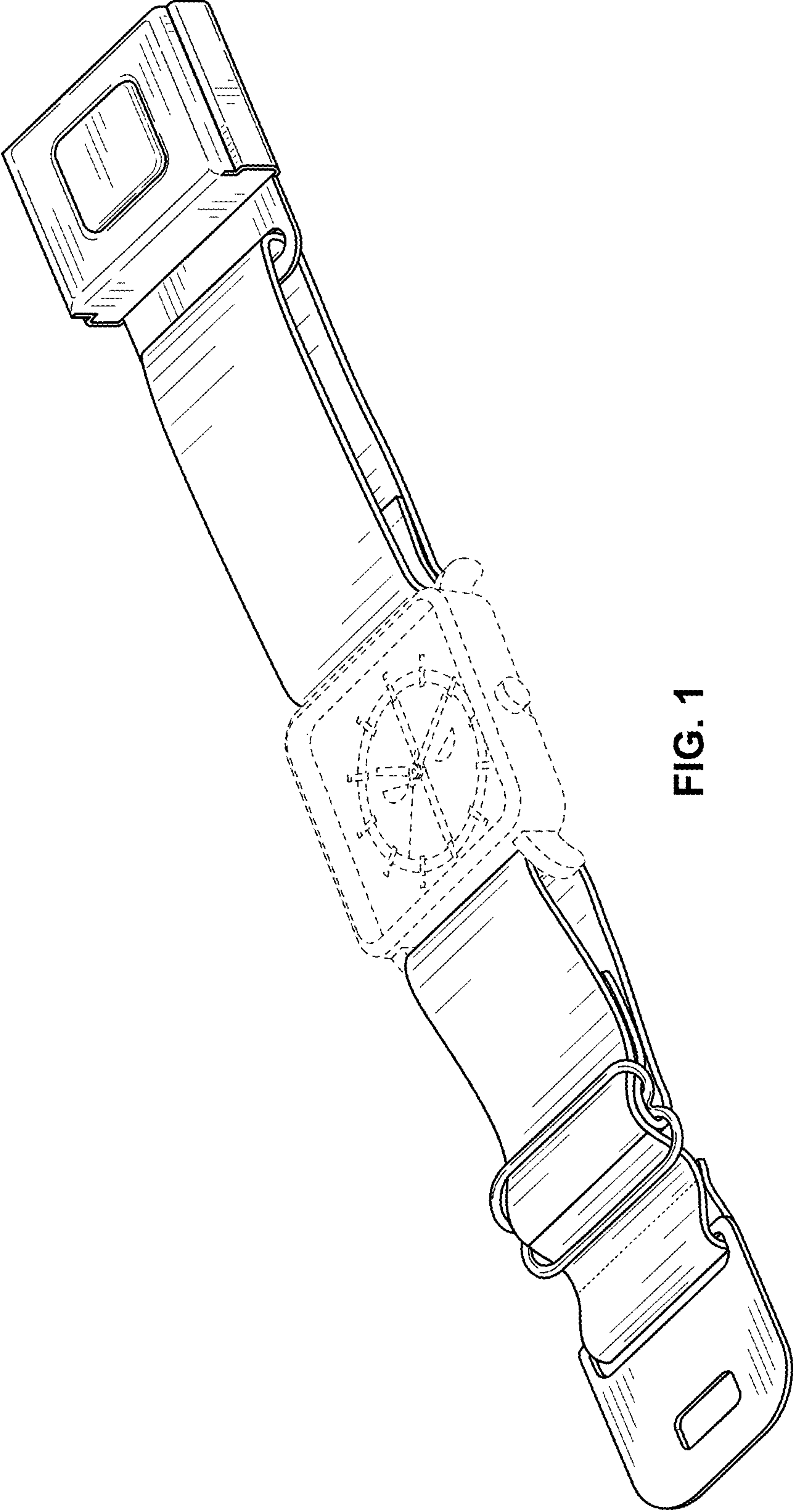

FIG. 1

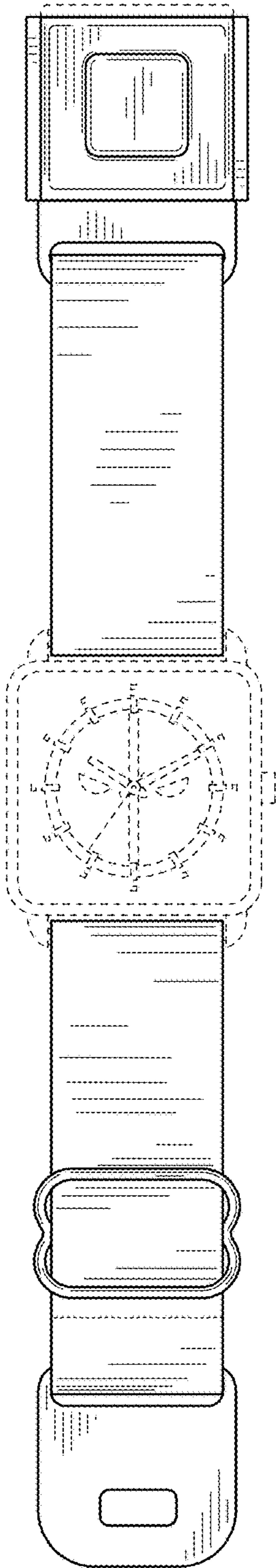

FIG. 2

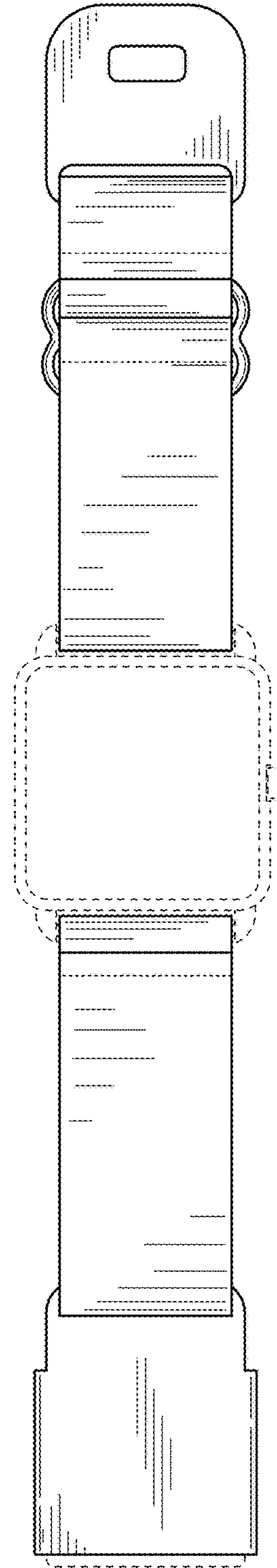

FIG. 3

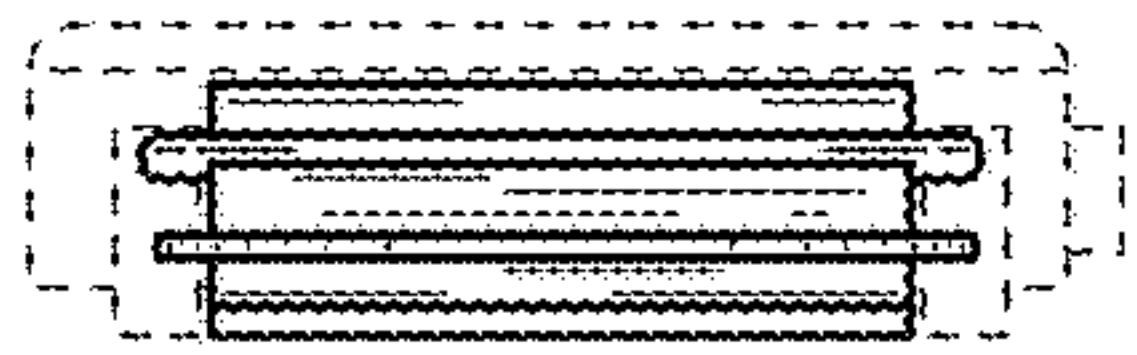

FIG. 4



FIG. 5

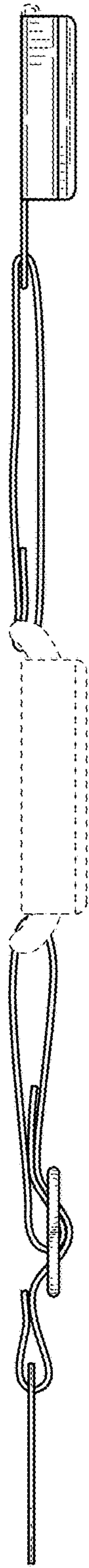

FIG. 6

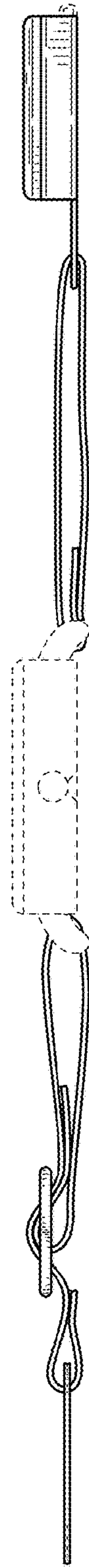

FIG. 7