



US00D790311S

(12) **United States Design Patent** (10) **Patent No.:** **US D790,311 S**
Tseng (45) **Date of Patent:** **** Jun. 27, 2017**

(54) **TOOL ASSEMBLY**

8,257,131 B2 9/2012 Truckai
2005/0098001 A1 5/2005 Walker
2010/0294089 A1 11/2010 Lai
2011/0088522 A1 4/2011 Floyd

(71) Applicant: **Allium LLC**, South Euclid, OH (US)

(72) Inventor: **Kuan-Chun Tseng**, Taiwan (CN)

(Continued)

(73) Assignee: **ALLIUM LLC**, South Euclid, OH (US)

FOREIGN PATENT DOCUMENTS

(**) Term: **15 Years**

GB 2225971 6/1990

(21) Appl. No.: **29/539,089**

OTHER PUBLICATIONS

(22) Filed: **Sep. 10, 2015**

Patent Cooperation Treaty (PCT), International Search Report and
Written Opinion for Application PCT/US2015/49447, mailed Dec.
10, 2015, 7 pp., International Searching Authority, US.

(51) **LOC (10) Cl.** **08-04**

(52) **U.S. Cl.**
USPC **D8/86**

(Continued)

(58) **Field of Classification Search**
USPC D8/14, 21, 29, 82, 83, 84, 85, 86, 105;
D19/36, 49, 43
CPC B25B 15/00; B25B 15/001; B25B 15/005;
B25B 23/00; B25B 23/0007; B25B
23/0035; B25B 23/0042; B25B 23/16
See application file for complete search history.

Primary Examiner — Phillip S Hyder

(74) *Attorney, Agent, or Firm* — McDonald Hopkins LLC

(57) **CLAIM**

The ornamental design for a tool assembly, as shown and
described.

DESCRIPTION

(56) **References Cited**

U.S. PATENT DOCUMENTS

2,758,494	A *	8/1956	Jenkins	B25B 13/56	279/128
4,399,723	A	8/1983	Marleau			
5,044,804	A	9/1991	Chuang			
5,842,394	A	12/1998	Hwang			
5,899,127	A	5/1999	Shiao			
5,904,080	A	5/1999	Anderson et al.			
6,149,330	A	11/2000	Chuang			
D437,535	S *	2/2001	Boukhny	D8/21	
6,332,382	B1 *	12/2001	Anderson	B25B 15/001	81/125
D475,085	S	5/2003	Whitehorn			
6,688,792	B1	2/2004	Reichmann et al.			
D502,215	S	2/2005	Hung			
7,156,002	B1 *	1/2007	Chan	B25B 15/001	81/177.4
8,220,368	B2	7/2012	Chen			

FIG. 1 is a perspective view of a tool assembly showing my
new design;
FIG. 2 is a first side view thereof;
FIG. 3 is a second side view thereof;
FIG. 4 is a front view thereof;
FIG. 5 is a rear view thereof;
FIG. 6 is a top view thereof;
FIG. 7 is a bottom view thereof;
FIG. 8 is a bottom and side perspective view thereof;
FIG. 9 is a top and side perspective view thereof; and,
FIG. 10 is third side view thereof.

The elements depicted by broken line in FIGS. 9 and 10
illustrate portions of the tool assembly in which the design
is embodied that are not considered part of the claimed
design.

1 Claim, 5 Drawing Sheets

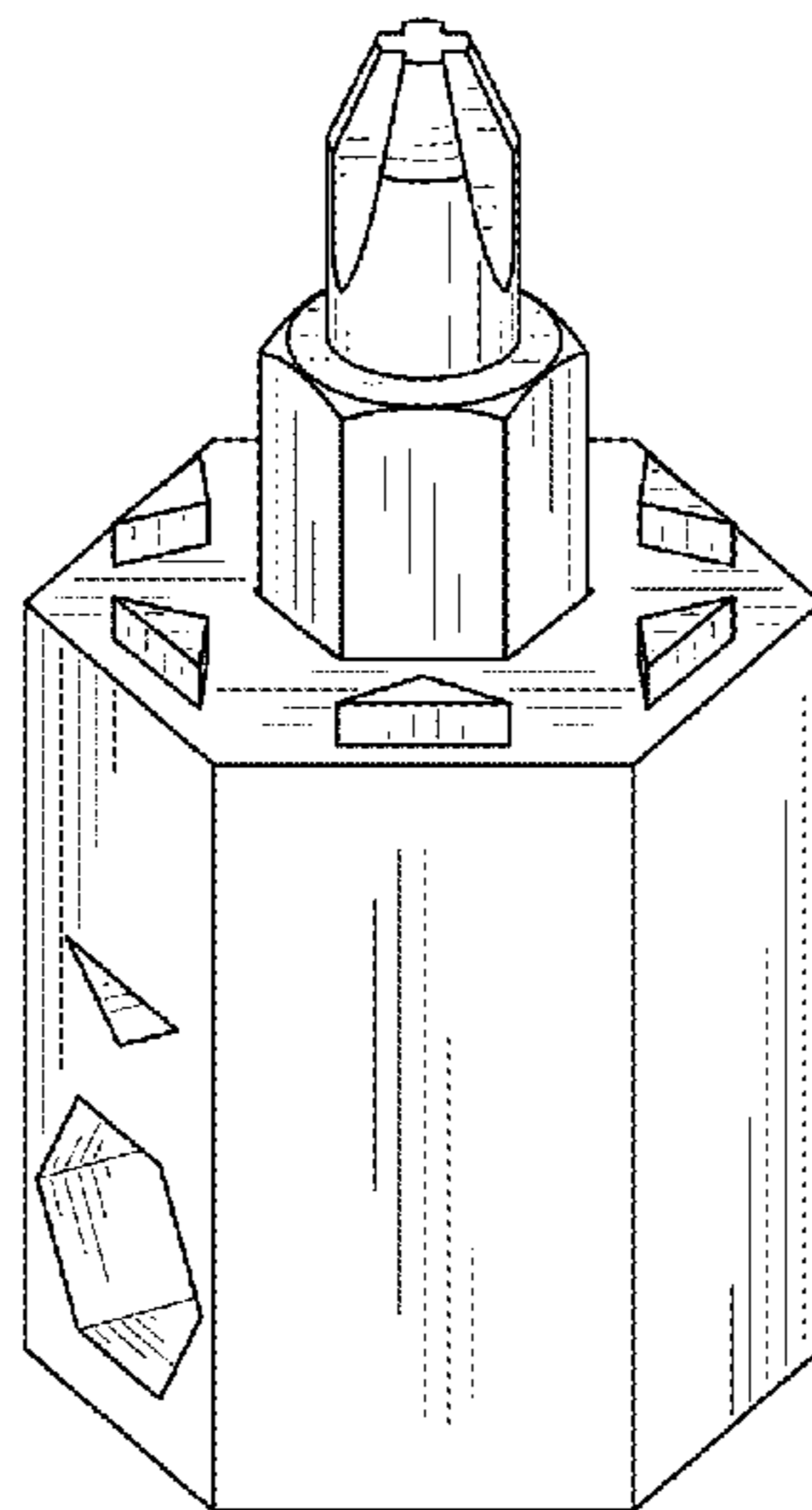

(56)

References Cited

U.S. PATENT DOCUMENTS

2015/0052686 A1 2/2015 Davis
2016/0039084 A1 2/2016 Tsai et al.

OTHER PUBLICATIONS

<https://www.youtube.com/watch?v=9rtllrNMYh0> (visited Oct. 30, 2015), Tech Blog (published: Apr. 13, 2015), entire video.
http://www.amazon.com/Polar-Magnetic-Modular-MAGNETS-Gold/dp/B00H0EJA7I/ref=cm_cr_arp_d_product_top?ie=UTF8 (visited Mar. 9, 2016).

* cited by examiner

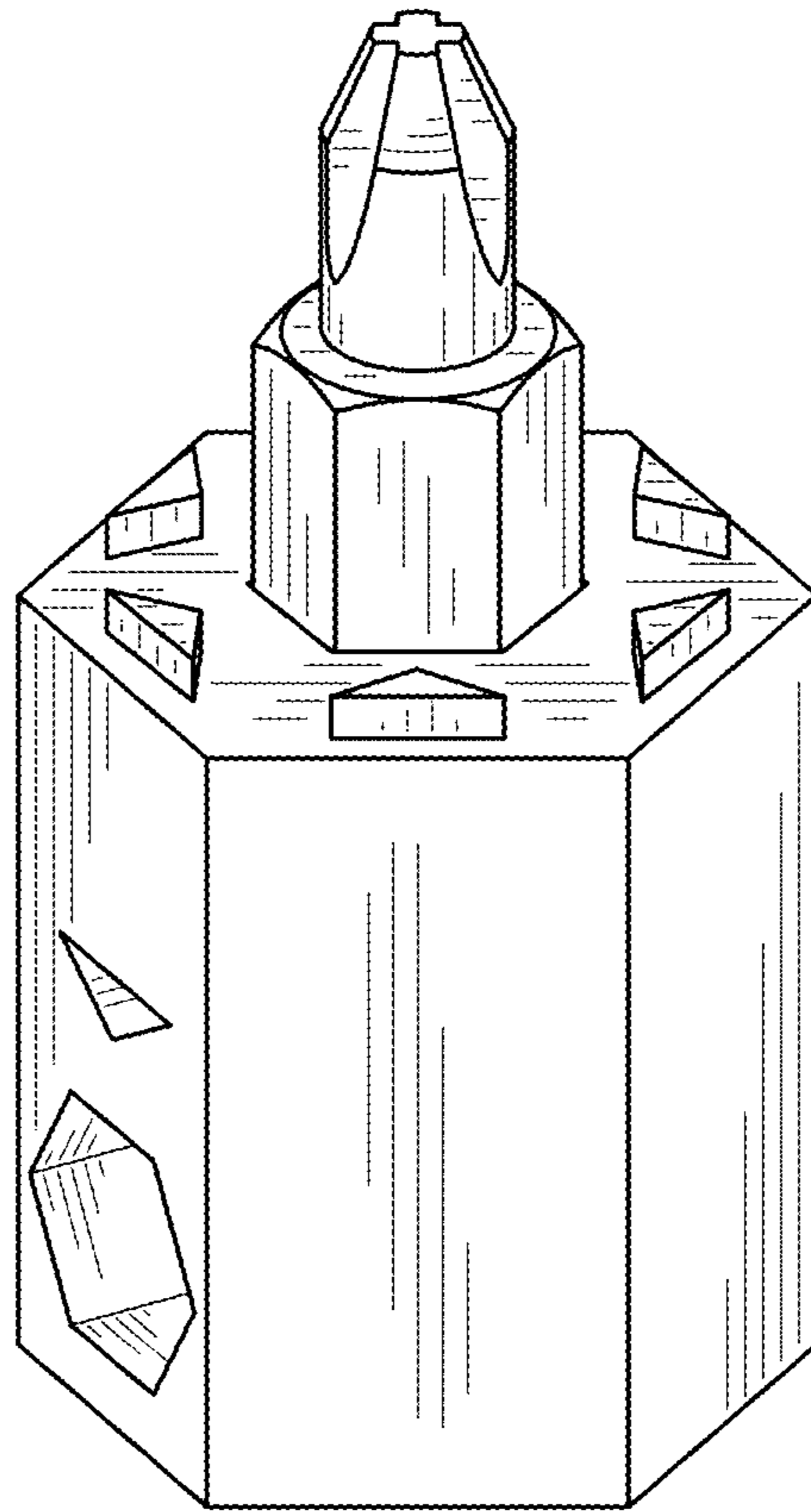

FIG. 1

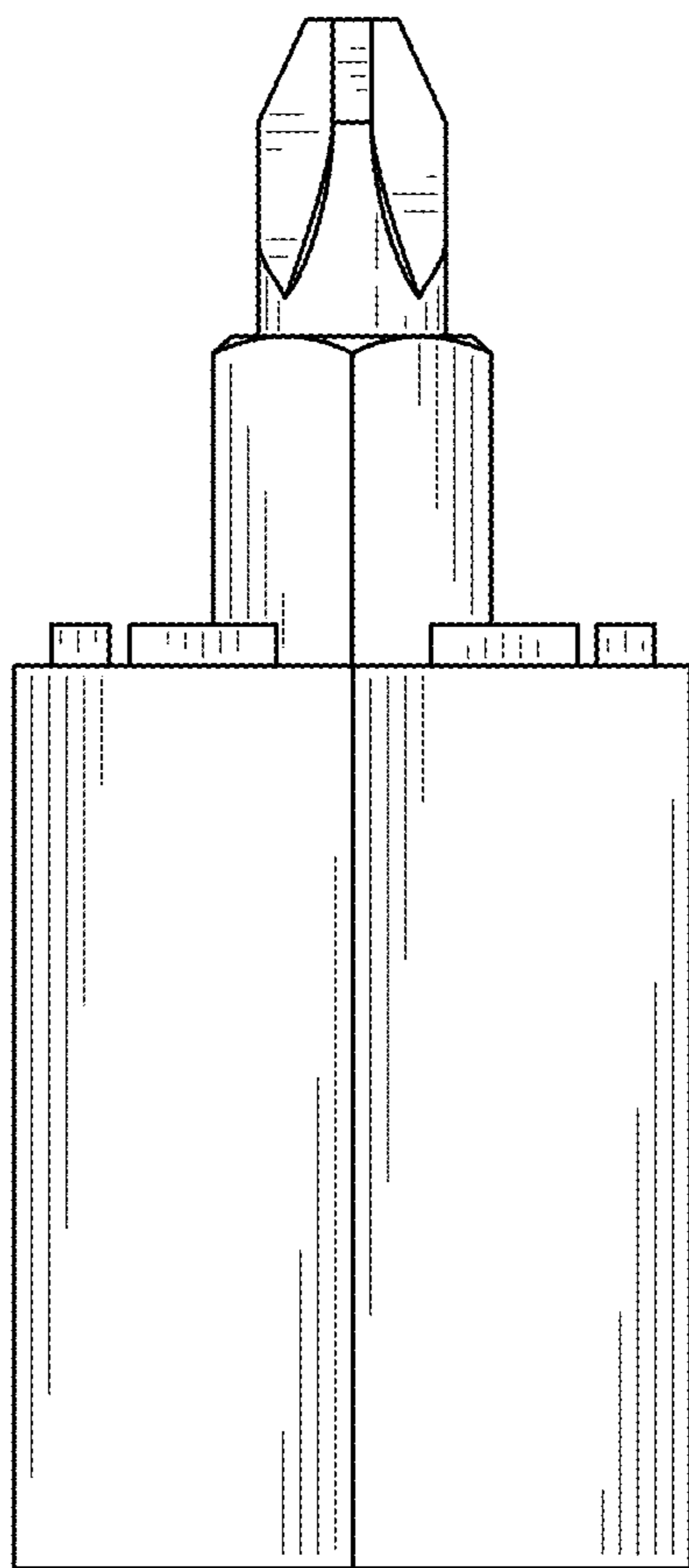

FIG. 2

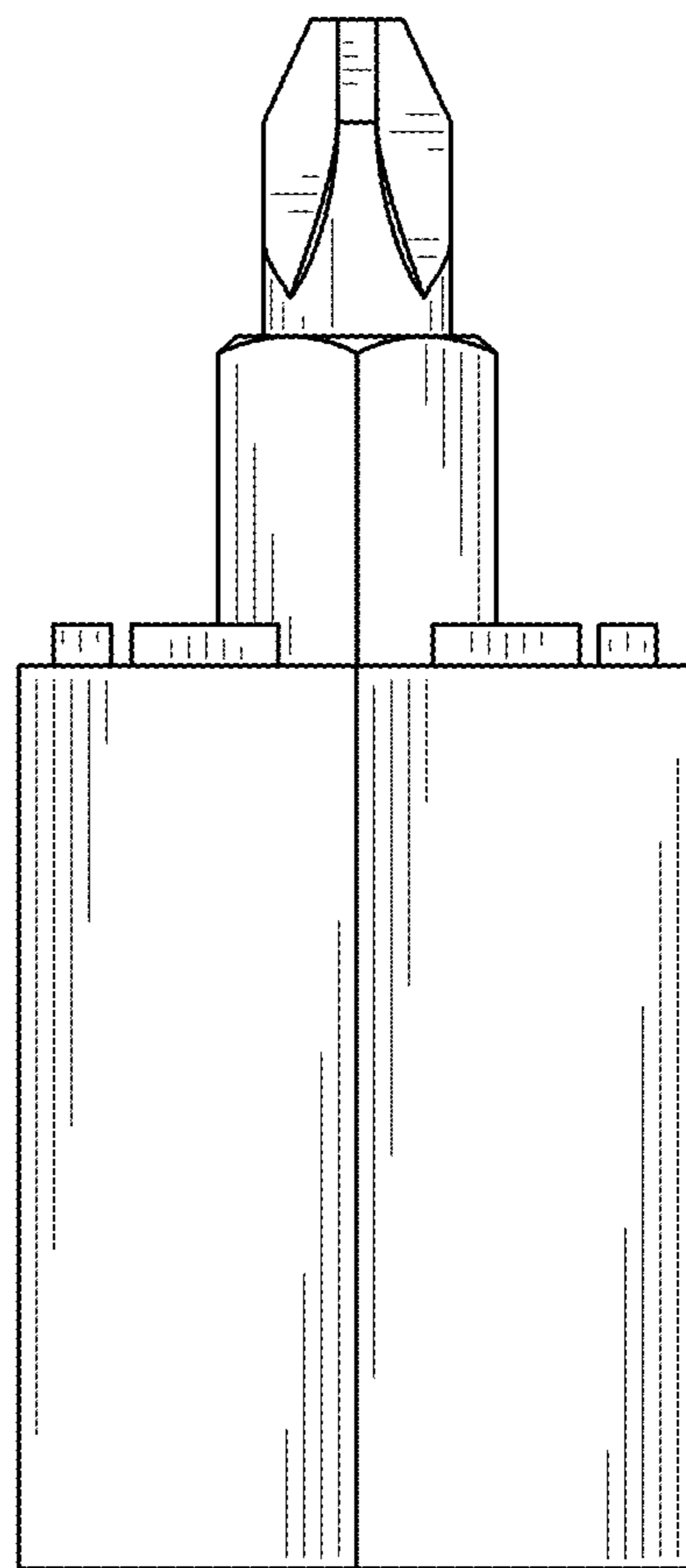

FIG. 3

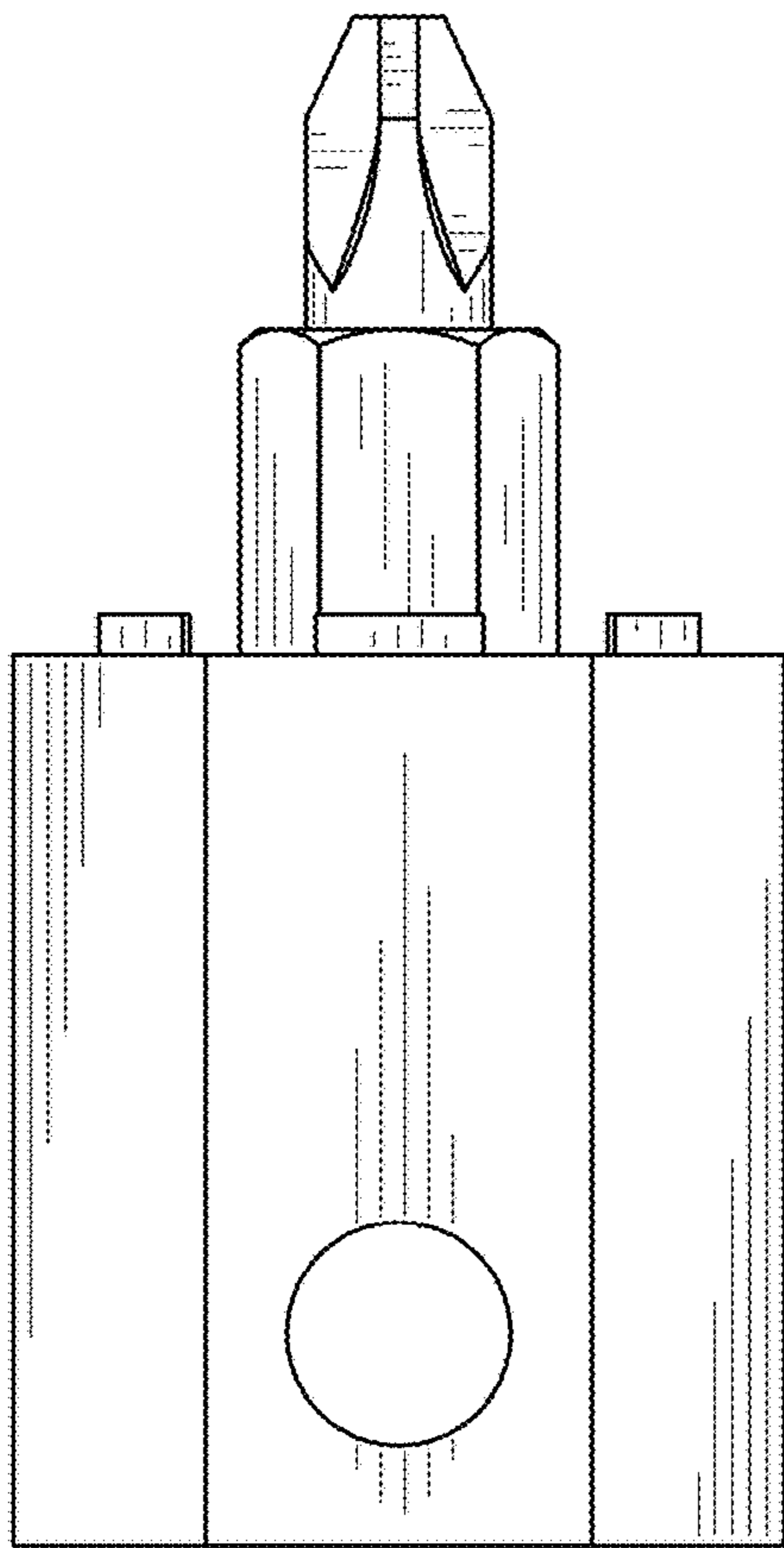

FIG. 4

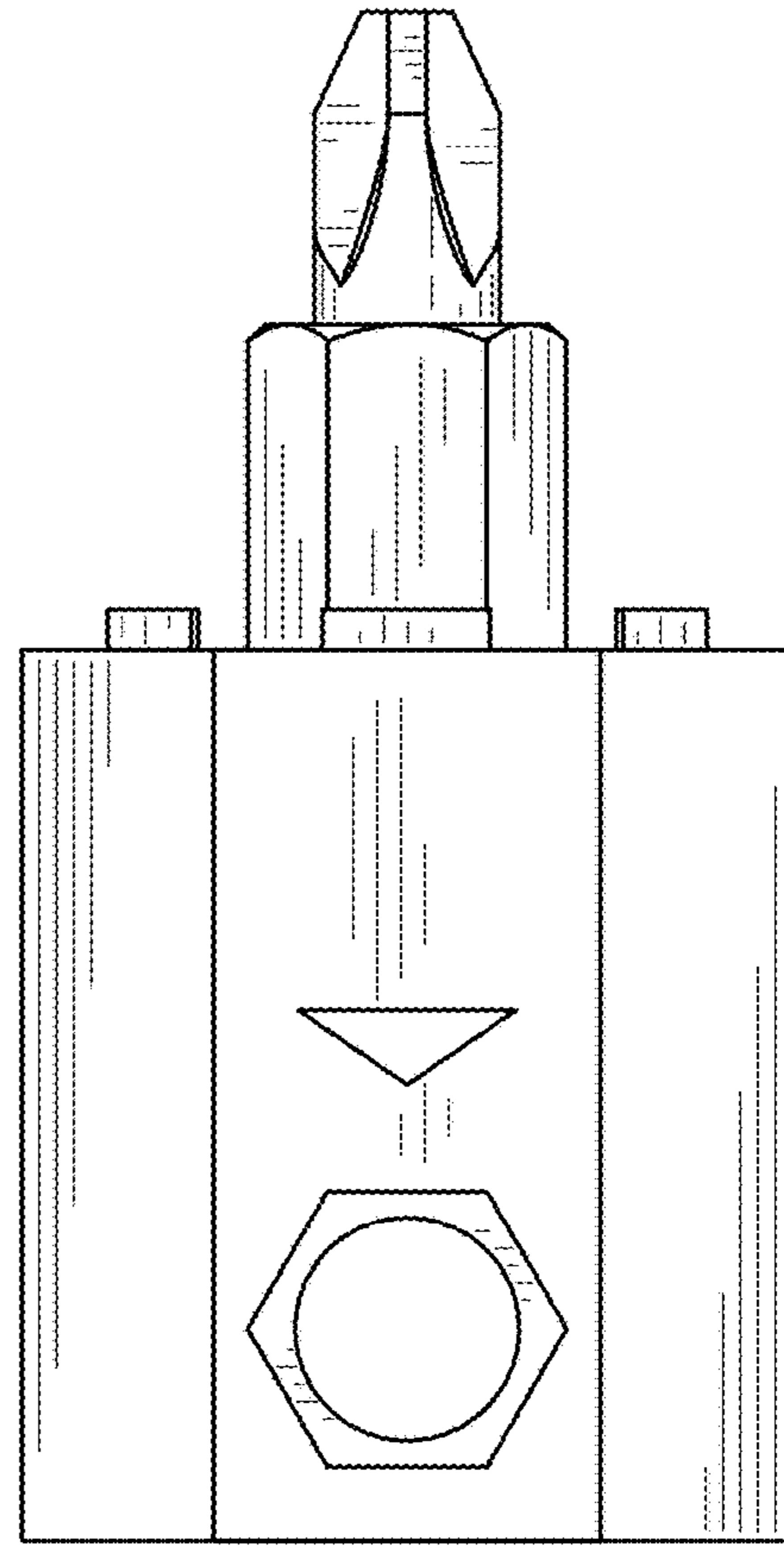

FIG. 5

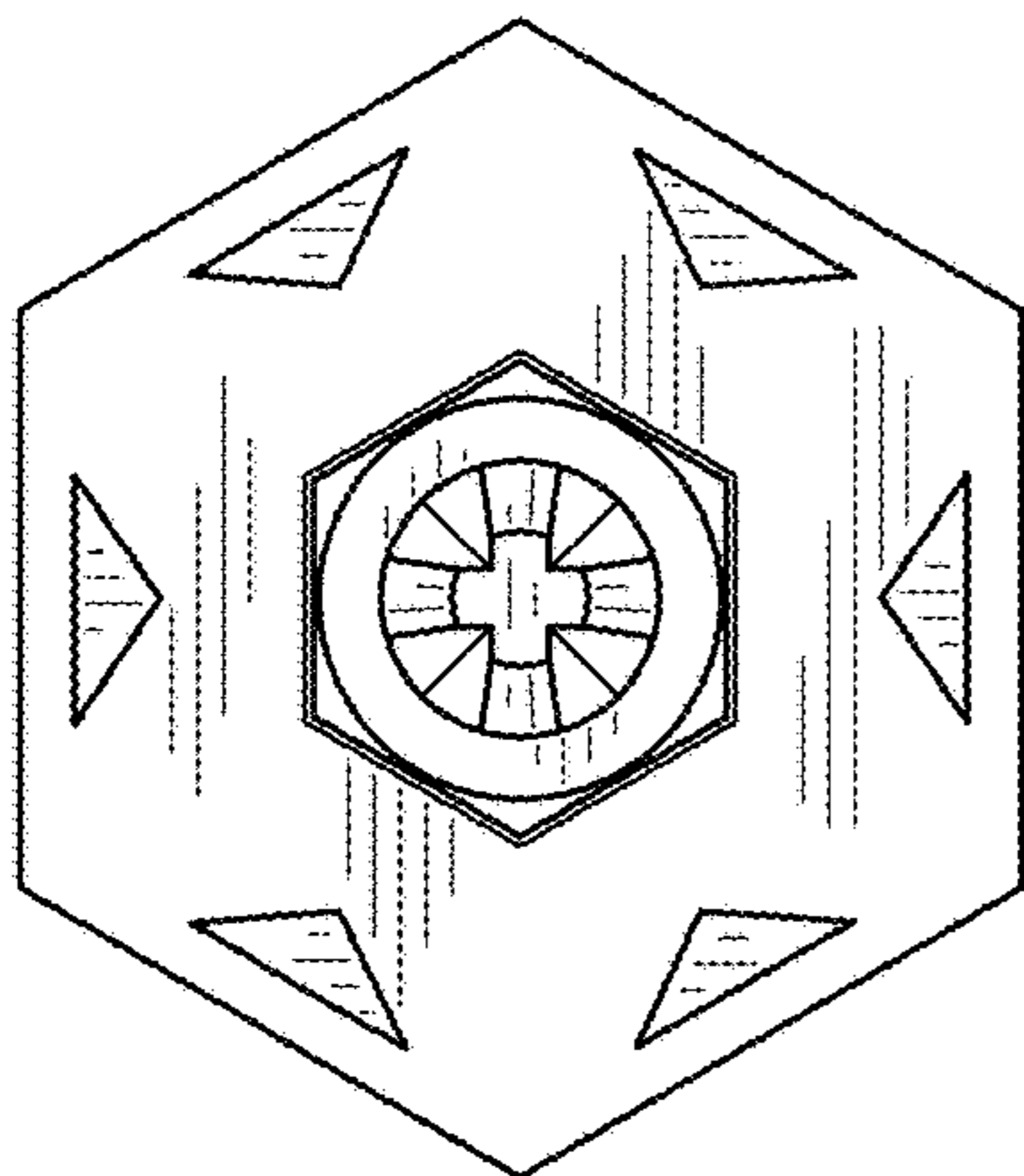

FIG. 6

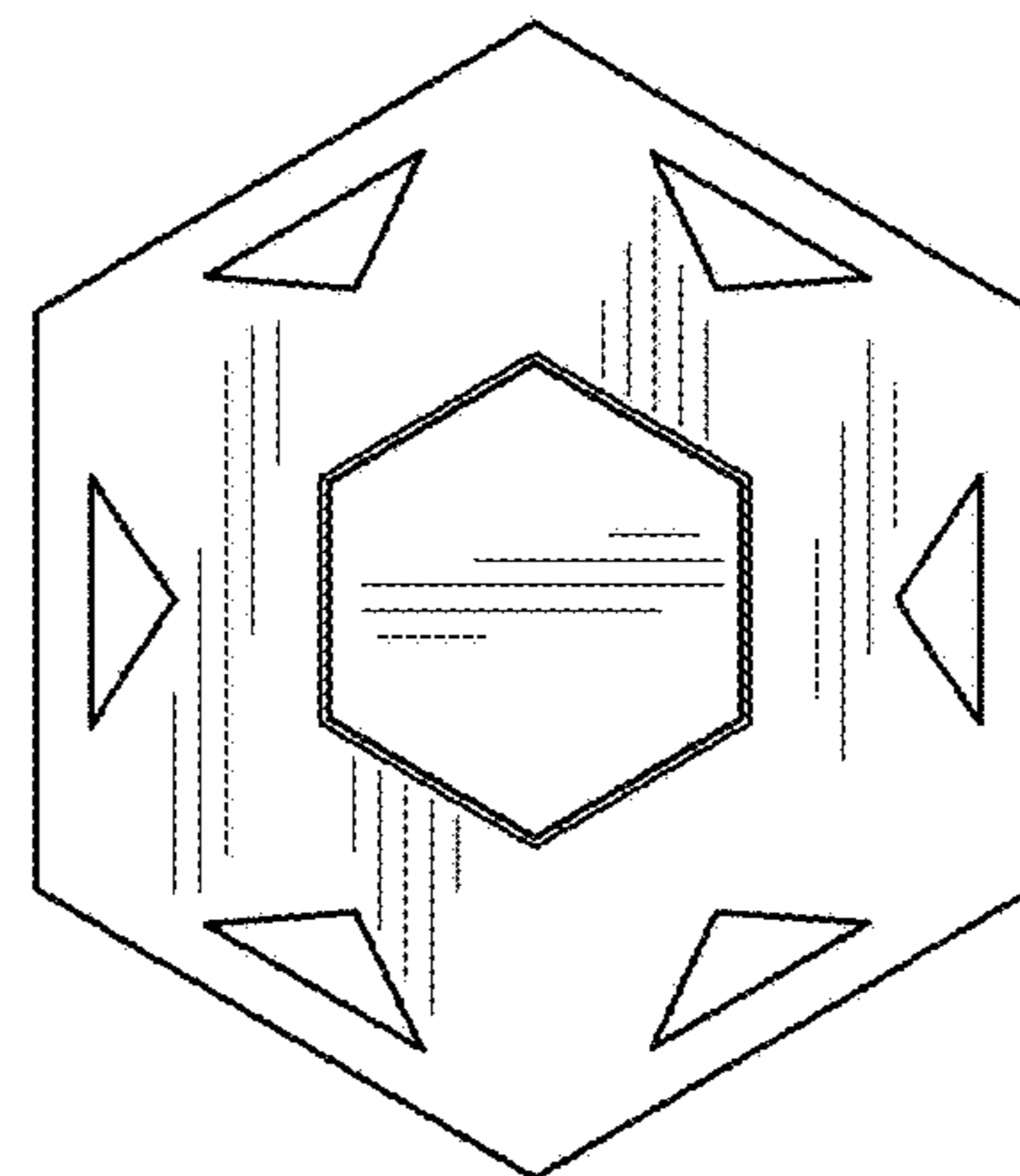

FIG. 7

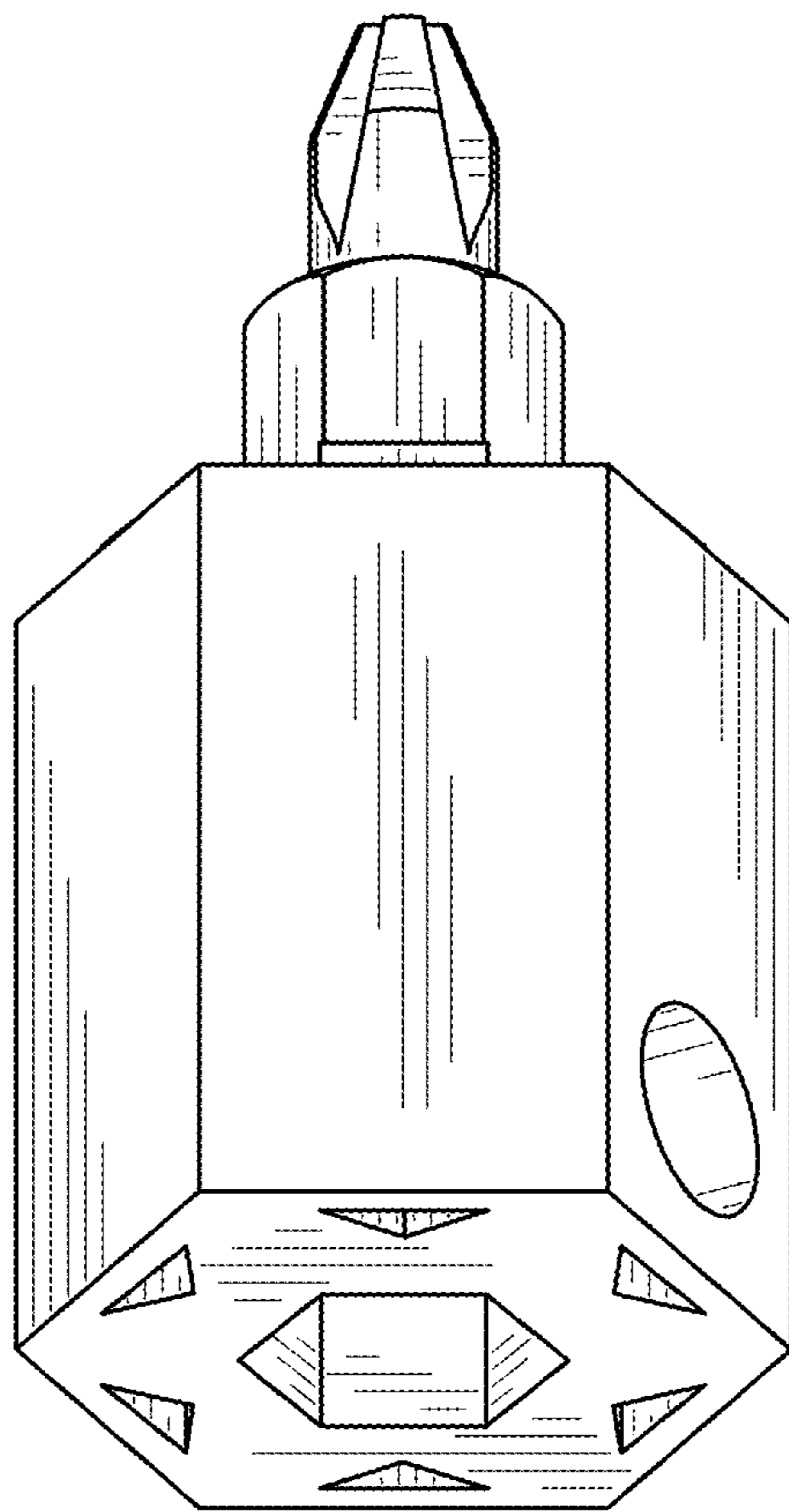

FIG. 8

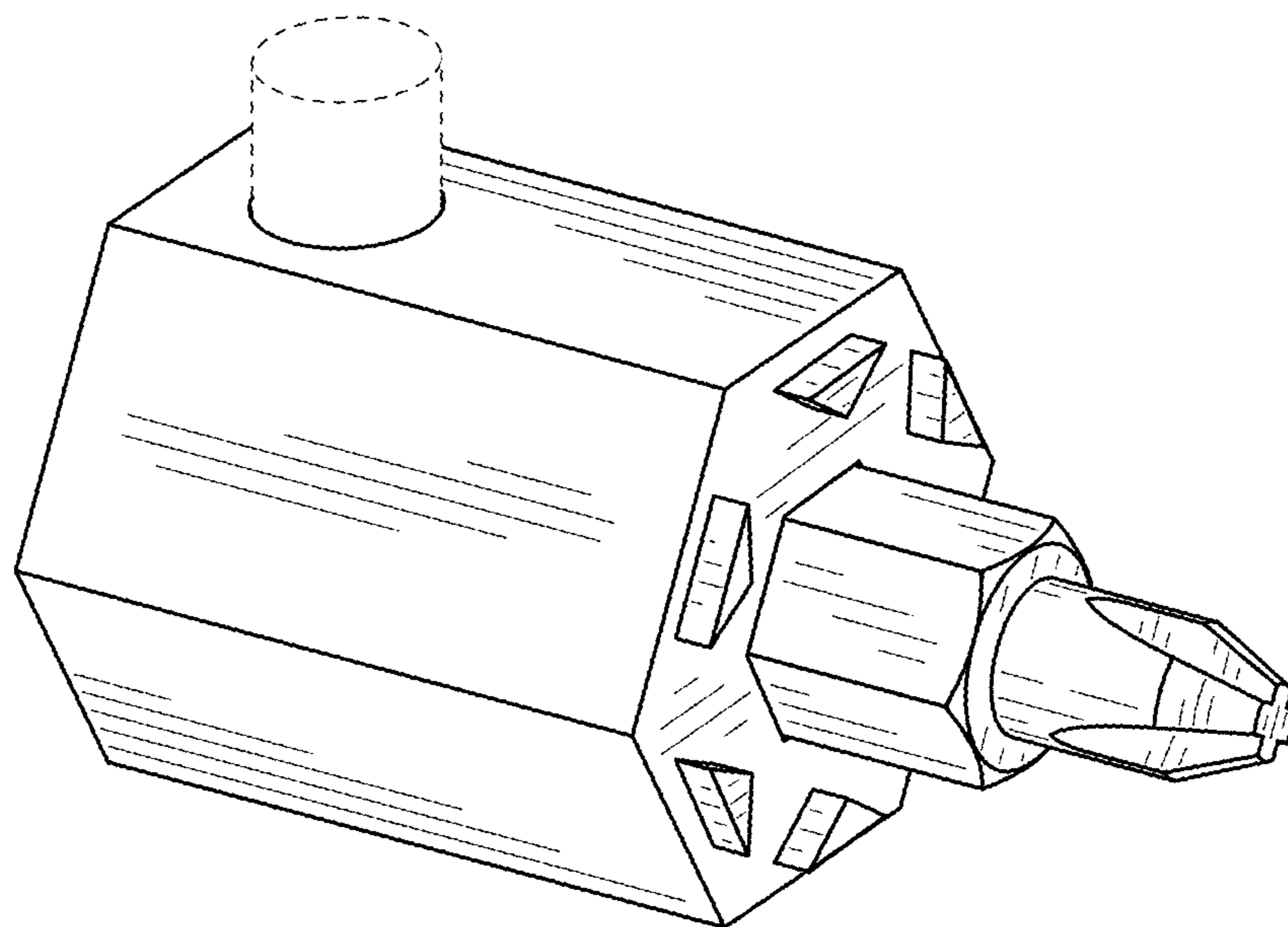

FIG. 9

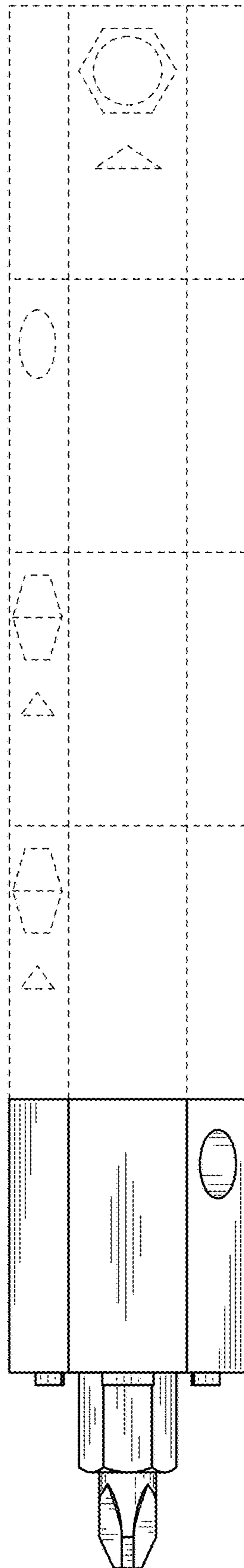

FIG. 10