



US00D790289S

(12) **United States Design Patent**  
**Singer**

(10) **Patent No.:** **US D790,289 S**

(45) **Date of Patent:** **\*\* Jun. 27, 2017**

(54) **KNIFE**  
(71) Applicant: **Norman Singer**, Beit Shemesh (IL)  
(72) Inventor: **Norman Singer**, Beit Shemesh (IL)  
(\*\*) Term: **15 Years**

492,409 A \* 2/1893 May ..... B26B 29/02  
30/295  
D22,439 S 5/1893 McGuigan  
538,459 A 4/1895 McCausland  
605,577 A 6/1898 Hutchinson  
649,059 A \* 5/1900 Kern ..... B26B 29/02  
30/295

(Continued)

(21) Appl. No.: **29/548,797**

**FOREIGN PATENT DOCUMENTS**

(22) Filed: **Dec. 16, 2015**

CN 2052708 U 2/1990  
CN 201573219 U 9/2010

(51) **LOC (10) Cl.** ..... **07-03**

(Continued)

(52) **U.S. Cl.**

USPC ..... **D7/649**; D7/401.2

(58) **Field of Classification Search**

USPC ..... D7/393-395, 401.2, 642-652, 693,  
D7/695-696; D8/93, 97-100, 107, 300,  
D8/321; D22/117-118

CPC ..... A01B 1/20; A01B 1/22; A22C 25/006;  
A47G 21/06; A47G 21/065; A47J 17/02;

A61B 17/3211; A61B 17/3213; B21D  
53/64; B25G 3/36; B26B 1/00; B26B

1/08; B26B 1/10; B26B 3/00; B26B 3/02;  
B26B 3/03; B26B 3/04; B26B 3/06;

B26B 5/00; B26B 5/001; B26B 5/007;  
B26B 7/00; B26B 7/005; B26B 9/00;

B26B 9/02; B26B 11/00; B26B 11/006;  
B26B 17/00; B26B 17/006; B26B 29/02

See application file for complete search history.

**OTHER PUBLICATIONS**

Hilton Knife, <http://www.candlepowerforums.com/vb/showthread.php?343017-Another-Spyderco-paramilitary-2-review>, Aug. 23, 2012.

(Continued)

*Primary Examiner* — Ricky Pham

(74) *Attorney, Agent, or Firm* — Pearl Cohen Zedek  
Latzter Baratz LLP

(57)

**CLAIM**

The ornamental design for a knife, as shown and described.

**DESCRIPTION**

FIG. 1 is a top, front, right side perspective of the knife;

FIG. 2 is a right side elevation view thereof;

FIG. 3 is a left side elevation view thereof;

FIG. 4 is a rear elevation view thereof;

FIG. 5 is a front elevation view thereof;

FIG. 6 is a top plan view thereof; and,

FIG. 7 is a bottom plan view thereof.

The broken lines that appear on the drawings form no part of the claimed design and are included for illustrative purposes only.

**1 Claim, 3 Drawing Sheets**

(56)

**References Cited**

**U.S. PATENT DOCUMENTS**

108,141 A 10/1870 Houseman et al.  
165,841 A 7/1875 Kellogg  
173,955 A 2/1876 Hudson  
226,146 A 3/1880 Zimmerer  
235,425 A 12/1880 Gearon  
296,304 A 4/1884 Allen  
369,314 A 9/1887 Brougher  
391,268 A 10/1888 Parker  
490,577 A 1/1893 Memminger

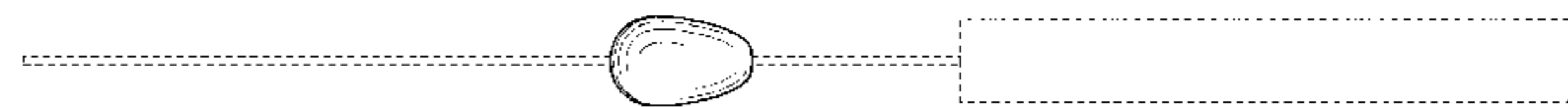
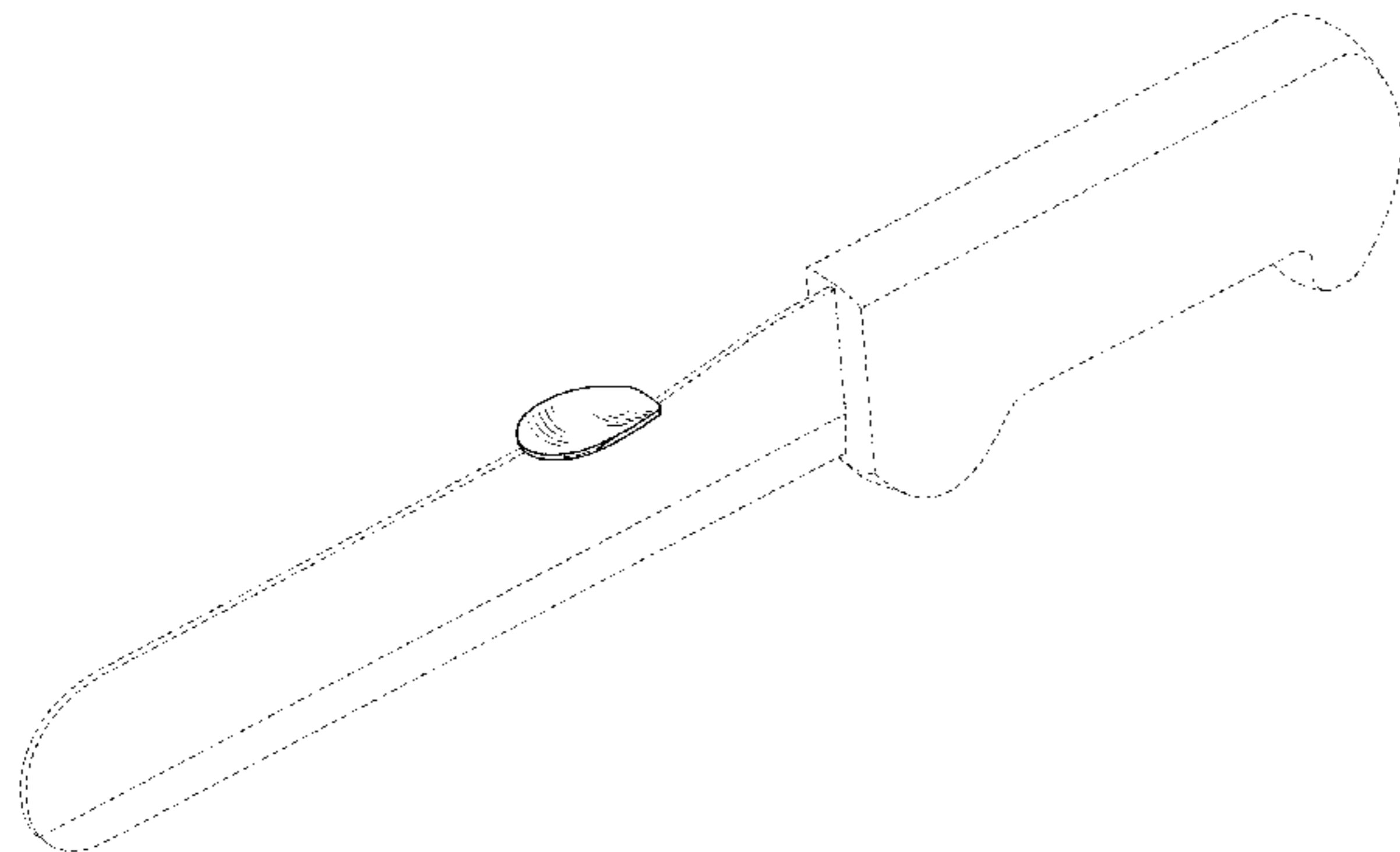

(56)

References Cited

U.S. PATENT DOCUMENTS

673,506 A 5/1901 Pitts  
 682,624 A 9/1901 Klickman  
 682,938 A 9/1901 Ingram  
 725,811 A 4/1903 Asbell  
 983,736 A 2/1911 Maconochie  
 1,118,507 A 11/1914 Meyer  
 1,299,084 A 4/1919 Wilson  
 1,333,960 A 3/1920 Brehm  
 1,491,623 A 4/1924 Pitchur  
 1,505,444 A 8/1924 Swanson  
 1,571,886 A \* 2/1926 North ..... B26B 9/00  
 30/155  
 1,602,032 A 10/1926 March  
 1,750,577 A \* 3/1930 De Bracht ..... A47J 17/02  
 30/295  
 1,967,479 A 7/1934 Platts  
 2,153,759 A 4/1939 Katzinger  
 2,168,237 A 8/1939 Polacsek  
 2,217,100 A 10/1940 Burns  
 D131,224 S 1/1942 Parisi  
 2,279,833 A 4/1942 Madan  
 2,315,898 A \* 4/1943 Krilow ..... B26B 9/02  
 30/345  
 D136,023 S 7/1943 Phillips  
 2,467,327 A 4/1949 McKee  
 2,494,306 A 1/1950 Morvey  
 D173,124 S 9/1954 Niblack  
 2,737,719 A 3/1956 Ember et al.  
 2,739,498 A 3/1956 Champlin  
 D177,743 S 5/1956 Marx  
 2,803,876 A 8/1957 Nelson  
 D202,780 S 11/1965 Baer  
 D235,841 S 7/1975 Cremonese  
 D239,623 S 4/1976 Behunin  
 D252,790 S 9/1979 Reinschreiber  
 4,178,684 A 12/1979 Mightly  
 D255,974 S 7/1980 Jacoby  
 D262,731 S 1/1982 Austin  
 4,578,864 A 4/1986 Hoffman  
 D306,957 S 4/1990 Cohen et al.  
 5,365,666 A 11/1994 Gonzalez  
 D391,115 S 2/1998 Robertson  
 D397,282 S \* 8/1998 Derkatz ..... D8/107  
 D405,338 S \* 2/1999 Balolia ..... D27/195  
 D439,806 S 4/2001 Juhlin et al.  
 D445,643 S \* 7/2001 Kazaklaris ..... D7/401.2  
 D461,681 S \* 8/2002 Lothe ..... D7/401.2  
 D461,688 S 8/2002 Lothe  
 6,502,314 B1 1/2003 McCatty  
 6,725,545 B2 4/2004 Frank  
 D537,850 S 3/2007 Moore et al.  
 D538,591 S 3/2007 Ashton, III  
 D539,086 S \* 3/2007 Aston, III ..... D7/401.2  
 D552,430 S 10/2007 Chen  
 D554,949 S 11/2007 Hood

7,302,760 B2 12/2007 Lake  
 7,434,320 B2 \* 10/2008 Aston, III ..... B26B 29/02  
 30/295  
 D600,506 S 9/2009 Miltner et al.  
 D612,694 S 3/2010 Eide et al.  
 D643,256 S 8/2011 Hirai  
 D643,257 S 8/2011 Hirai  
 D643,260 S \* 8/2011 Spiegel ..... D7/649  
 D643,261 S \* 8/2011 Spiegel ..... D7/649  
 8,082,669 B2 12/2011 Hayes  
 D677,551 S \* 3/2013 Pelton ..... B26B 11/006  
 D8/99  
 8,584,365 B2 11/2013 Zeitlin  
 8,707,490 B1 \* 4/2014 Pelton ..... B26B 1/00  
 30/123  
 8,732,958 B2 5/2014 Huang  
 D719,405 S \* 12/2014 Miller ..... D7/401.2  
 8,931,381 B2 \* 1/2015 Poran ..... B26B 29/02  
 30/1  
 8,943,935 B2 2/2015 Qian  
 9,132,559 B2 9/2015 Hatch et al.  
 D750,948 S \* 3/2016 Pelton ..... D8/99  
 D766,672 S \* 9/2016 Mishan ..... D7/649  
 D766,673 S \* 9/2016 Mishan ..... D7/649  
 D766,674 S \* 9/2016 Mishan ..... D7/649  
 D774,354 S \* 12/2016 Scobey, Jr. .... D7/401.2  
 D781,666 S \* 3/2017 Mishan ..... D7/401.2  
 2002/0170184 A1 11/2002 Lothe  
 2003/0182808 A1 10/2003 Mireles  
 2005/0241111 A1 11/2005 Prokop  
 2012/0159793 A1 \* 6/2012 Hatch ..... B26B 29/02  
 30/312  
 2013/0104403 A1 5/2013 Stokes  
 2016/0193742 A1 7/2016 Faiola  
 2016/0375598 A1 12/2016 Singer

FOREIGN PATENT DOCUMENTS

DE 29914226 U1 11/1999  
 KR 20090007796 U 8/2009

OTHER PUBLICATIONS

Jade Knife, <http://andy321.proboards.com/thread/50295/jade-knife>, Feb. 1, 2012.  
 Tac-Force TF-578BK Karambit A/O Finger Ring Knife, <http://www.moosecreekgear.com/tac-force-tf578bk-karambit-aolinerlock-knife.html>, last accessed Jun. 25, 2015.  
 Gerber Myth Pocket Folder Knife, <http://www.amazon.com/Gerber-Myth-Pocket-Folder-Knife/dp/B00P6M07B4>, last accessed Jun. 25, 2015.  
 High Desert Survival School Knife, <http://jasonklass.blogspot.in/2011/05/high-desert-survival-school-knife.html>, last accessed Jun. 25, 2015.

\* cited by examiner

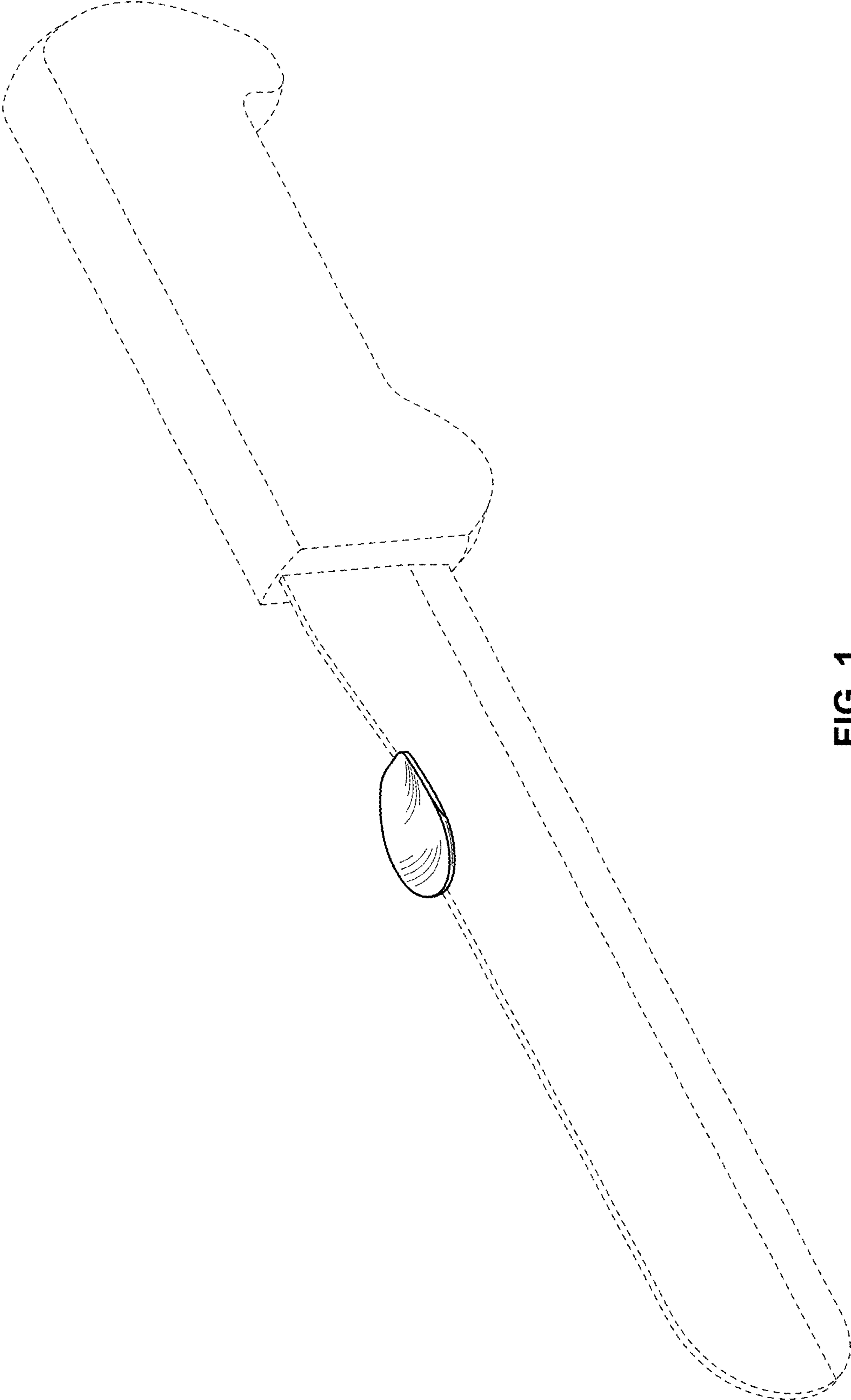

FIG. 1

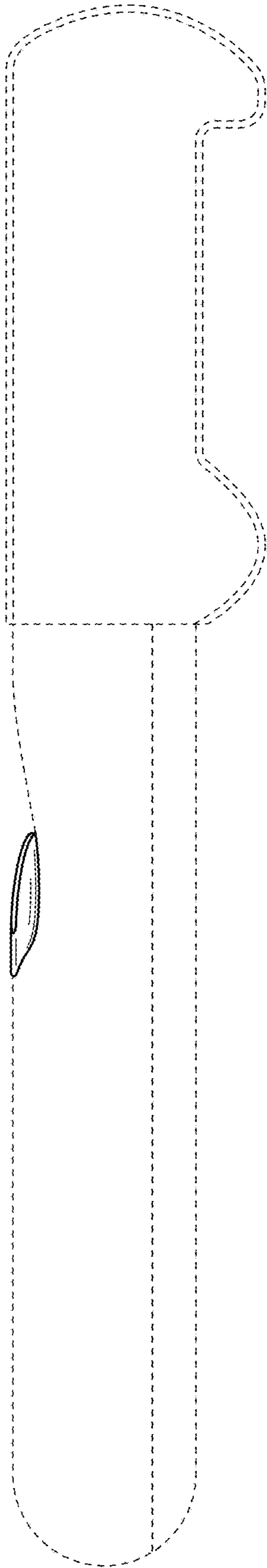

FIG. 2

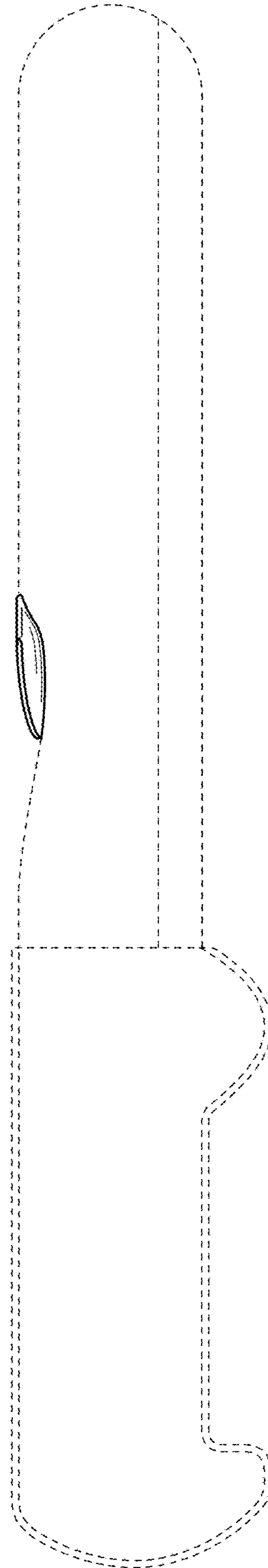

FIG. 3



FIG. 4

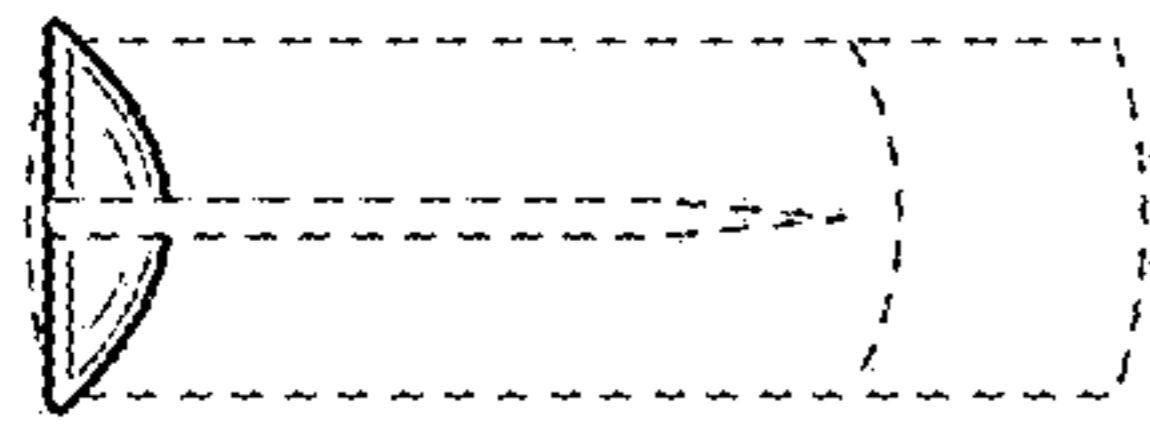

FIG. 5

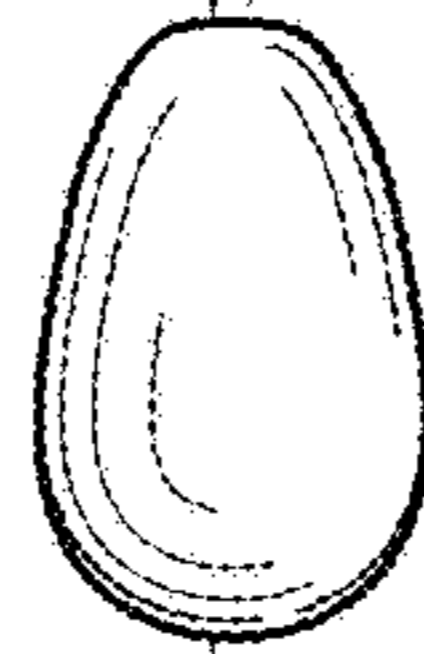

FIG. 6

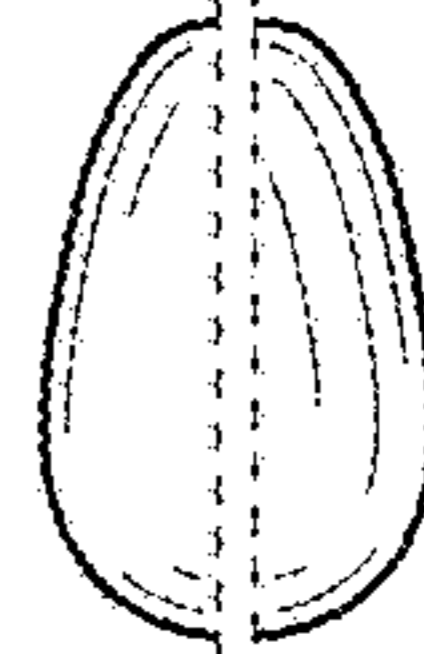
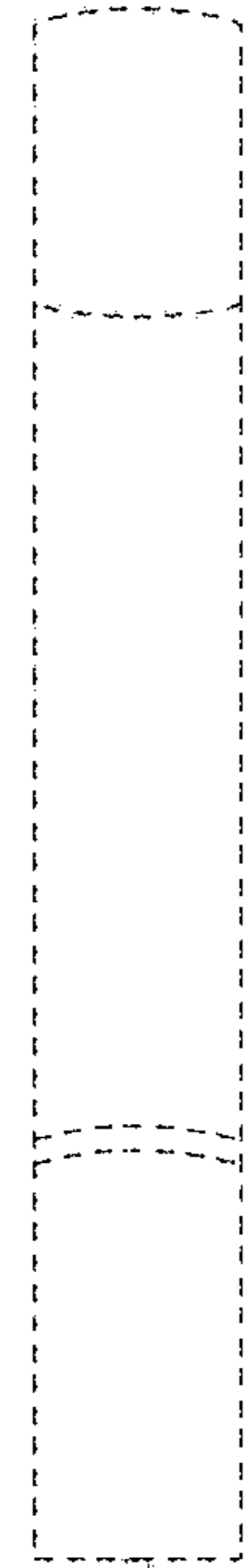

FIG. 7