



US00D790255S

(12) **United States Design Patent** (10) **Patent No.:** **US D790,255 S**
Mi (45) **Date of Patent:** **** Jun. 27, 2017**

(54) **CUSHION**

(71) Applicant: **SHENZHEN QISHENGXIENENG ELECTRONIC CO., LTD.**, Shenzhen, Guangdong (CN)

(72) Inventor: **Shuangtian Mi**, Chengdu (CN)

(73) Assignee: **SHENZHEN QISHENGXIENENG ELECTRONIC CO., LTD.**, Shenzhen, Guangdong Province (CN)

(**) Term: **15 Years**

(21) Appl. No.: **29/562,099**

(22) Filed: **Apr. 22, 2016**

(51) **LOC (10) Cl.** **06-09**

(52) **U.S. Cl.**
USPC **D6/601**

(58) **Field of Classification Search**
USPC D6/333, 349, 355, 375, 388, 512, 563, D6/564, 595, 596, 601, 604, 611, 707, D6/715, 716, 716.1; D24/183–185, 234; D21/803, 804, 805, 809; 5/401, 420, 5/600, 630, 631, 632, 633, 635, 636, 638, 5/639, 646, 652, 652.1, 655, 703, 730; 297/1, 2, 4, 93, 180.11, 195.1, 195.11, 297/195.13, 393, 397, 452.12, 452.14, 297/452.15, 452.21, 452.24, 452.26, 297/452.48, 452.62, 482
CPC A47G 9/10; A47G 9/1009; A47G 9/1018; A47G 9/1027; A47G 9/1036; A47G 9/1045; A47G 9/1063; A47G 9/1072; A47G 9/1081; A47G 9/109; A47G 9/108; A47C 7/021; A47C 27/00

See application file for complete search history.

(56) **References Cited**

U.S. PATENT DOCUMENTS

2,765,480	A *	10/1956	Mueller	A47C 7/021
					5/630
3,305,878	A *	2/1967	Hellbaum	A47C 27/146
					5/630
5,692,246	A *	12/1997	Benedick	A61F 5/03
					2/455
D557,045	S *	12/2007	Faber	D3/274
D618,030	S *	6/2010	Wang	D6/601
D618,945	S *	7/2010	Tanaka	D6/601
D688,897	S *	9/2013	Yang	D6/601
D688,898	S *	9/2013	Yang	D6/601
D706,553	S *	6/2014	Webster	D6/390
D707,358	S *	6/2014	Mantilla	D24/184
D711,158	S *	8/2014	Ko	D6/601
D721,519	S *	1/2015	Gray, III	D6/601

* cited by examiner

Primary Examiner — Eric Goodman

Assistant Examiner — Sanjeev Paul

(74) *Attorney, Agent, or Firm* — Li & Cai Intellectual Property (USA) Office

(57) **CLAIM**

The ornamental design for a “cushion,” as shown and described.

DESCRIPTION

FIG. 1 is a perspective view of a cushion showing our new design;

FIG. 2 is a front view thereof;

FIG. 3 is a rear view thereof;

FIG. 4 is a left side view thereof;

FIG. 5 is a right side view thereof;

FIG. 6 is a top view thereof; and,

FIG. 7 is a bottom view thereof.

1 Claim, 5 Drawing Sheets

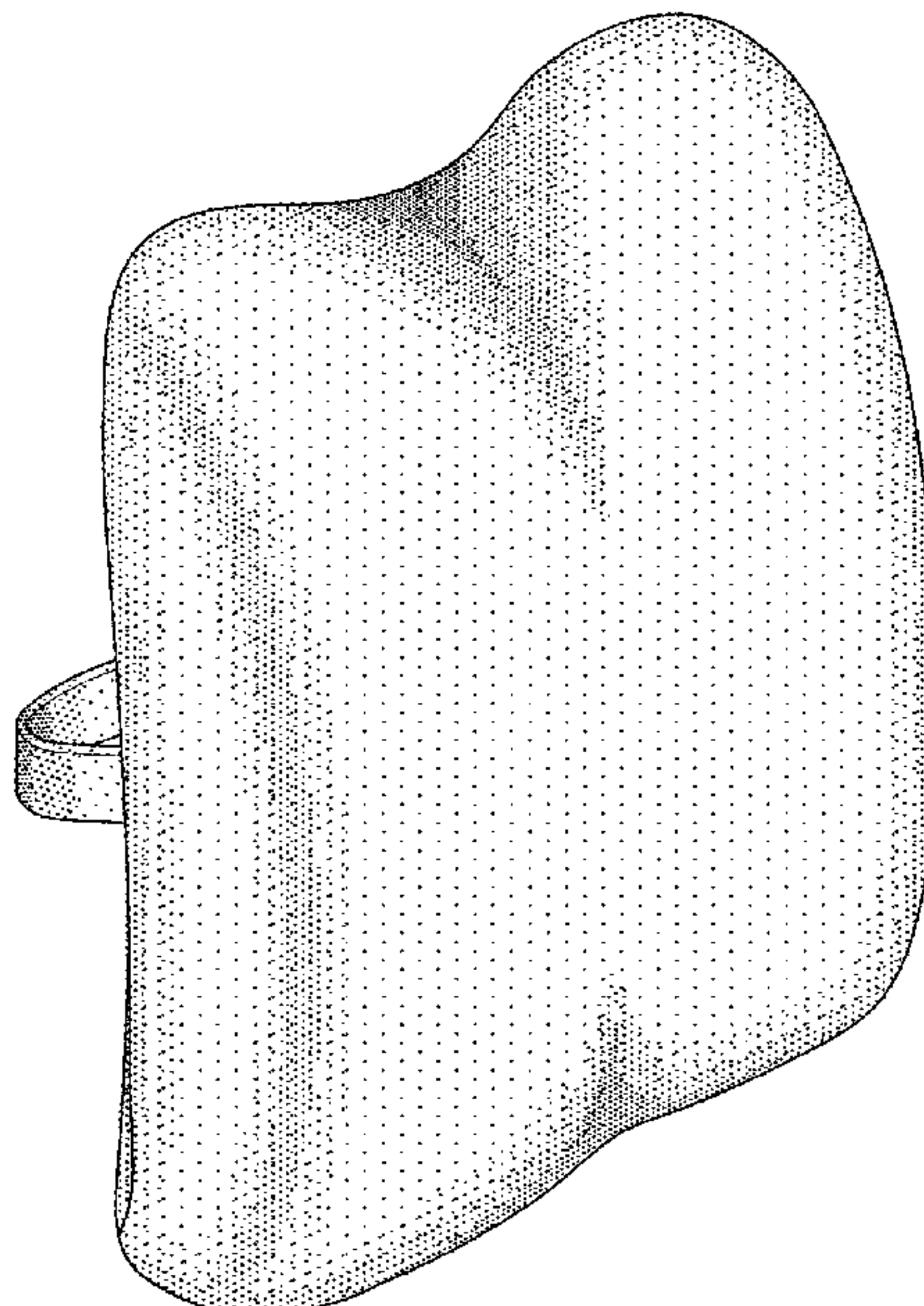

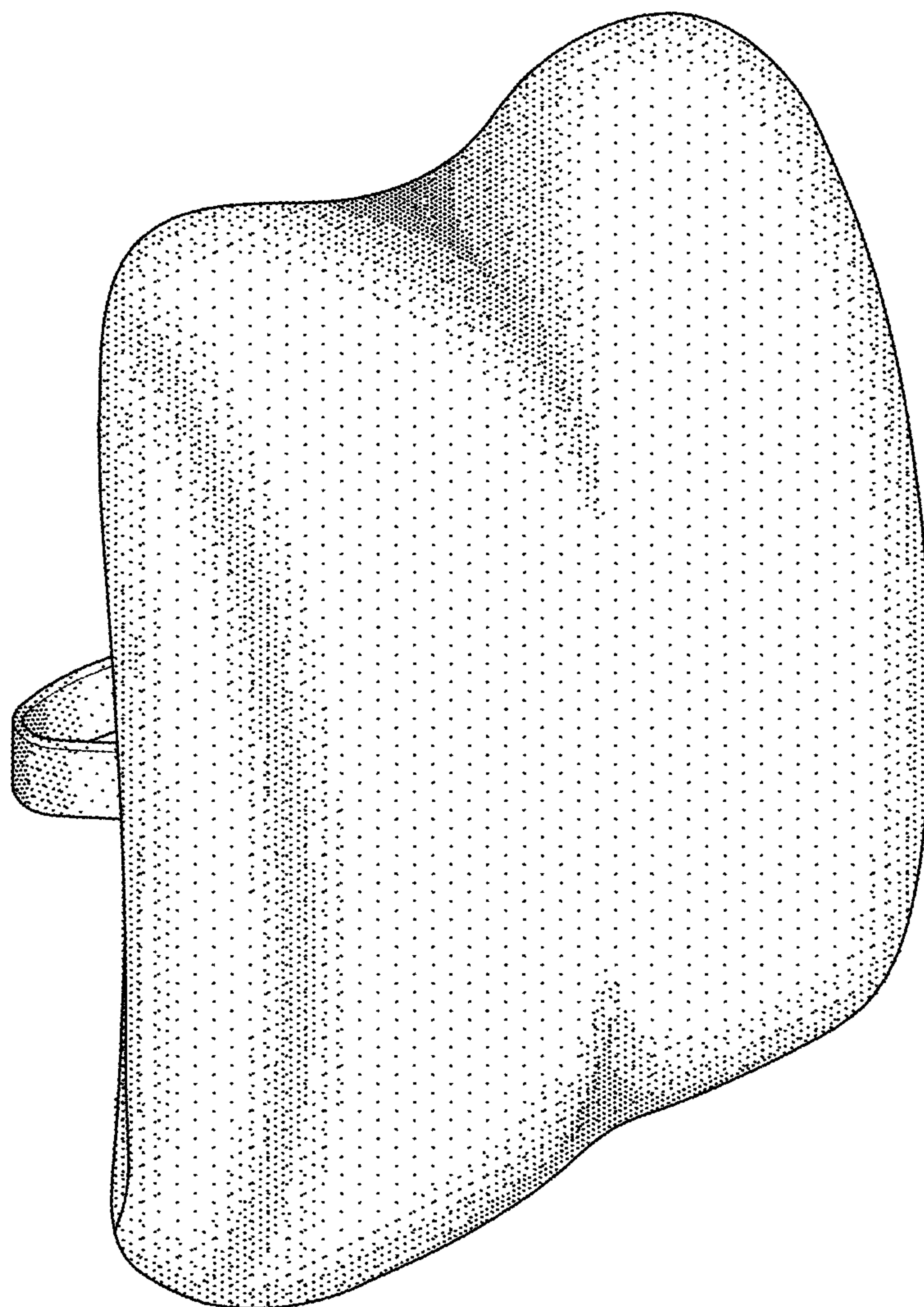

FIG.1

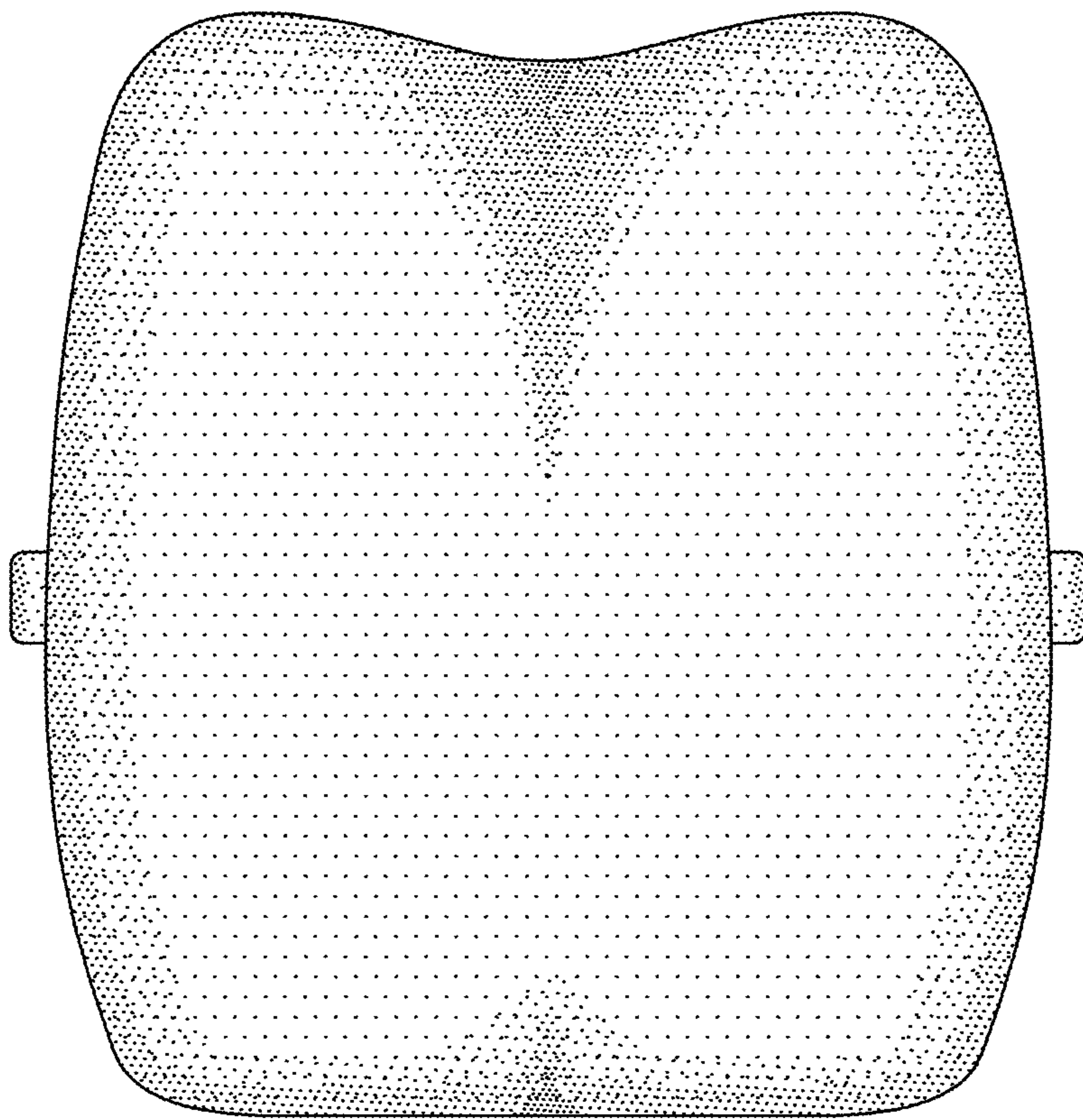

FIG.2

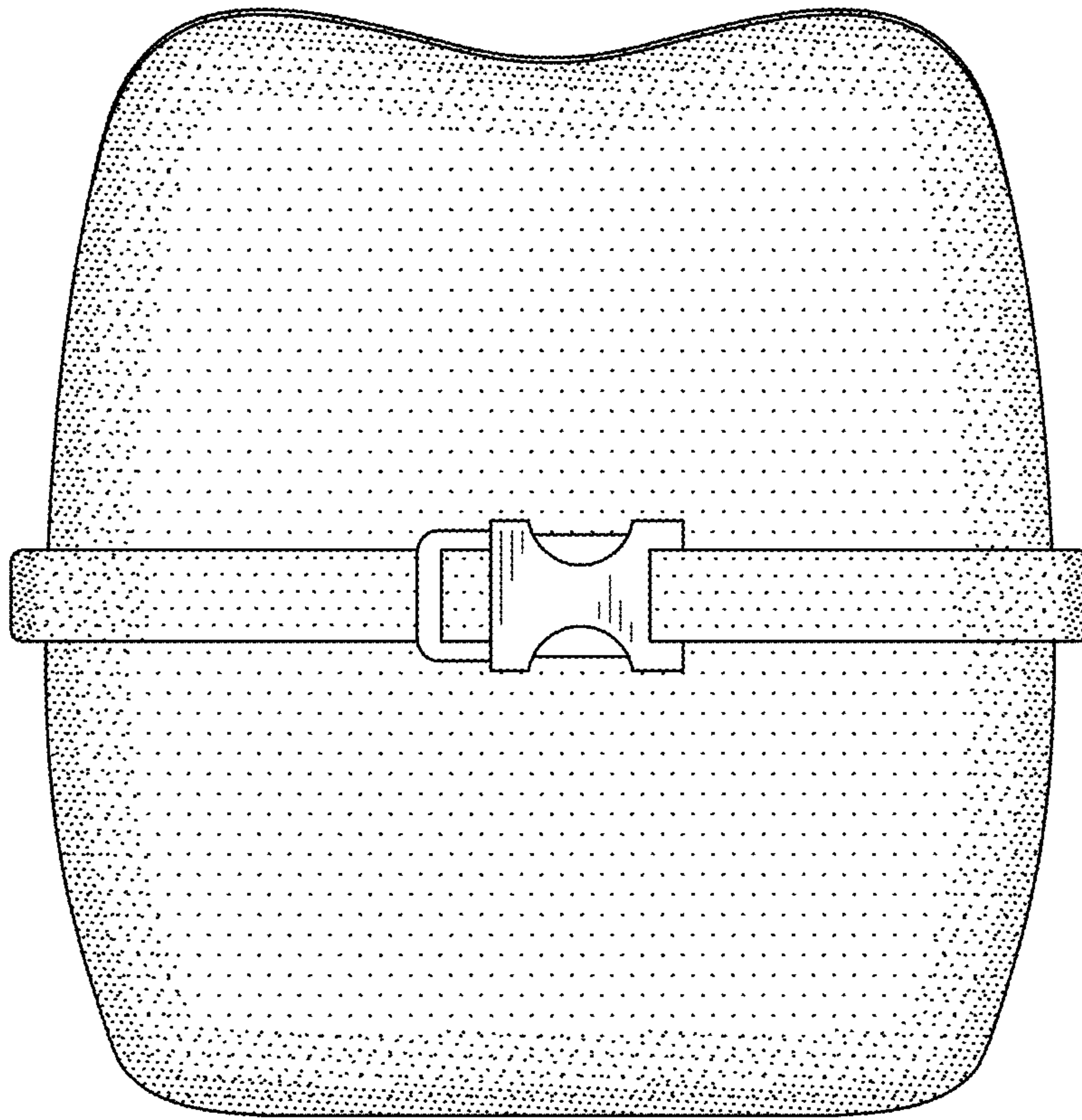

FIG. 3

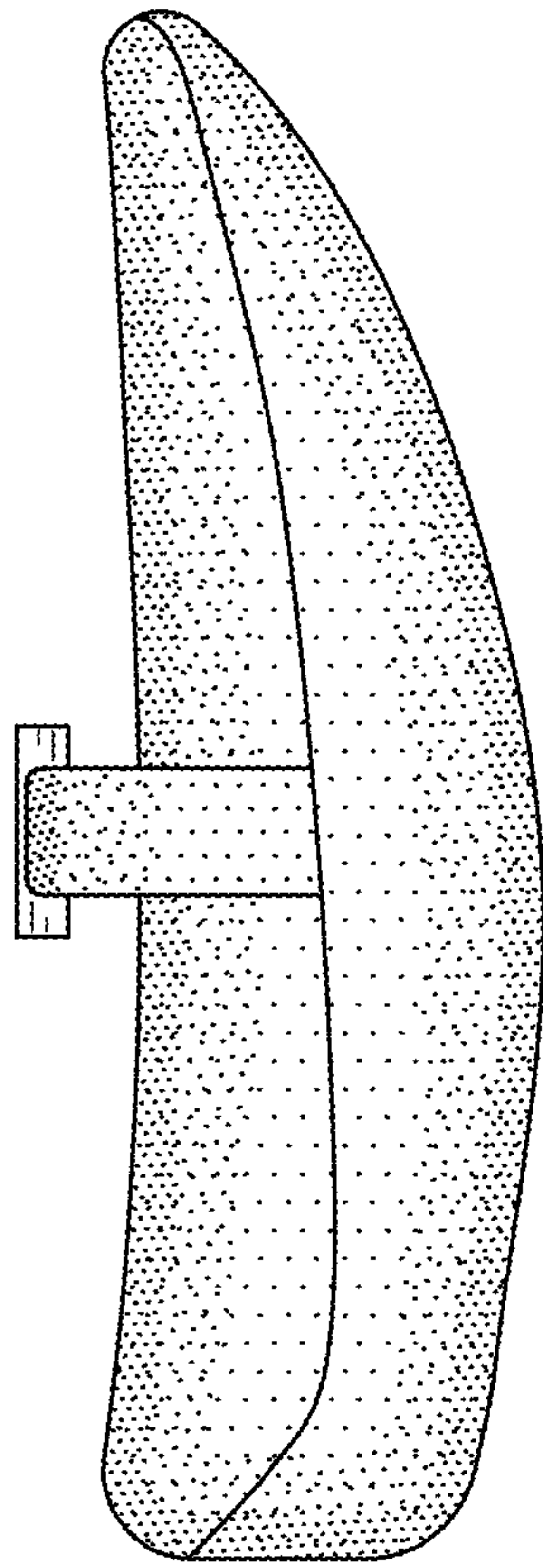

FIG.4

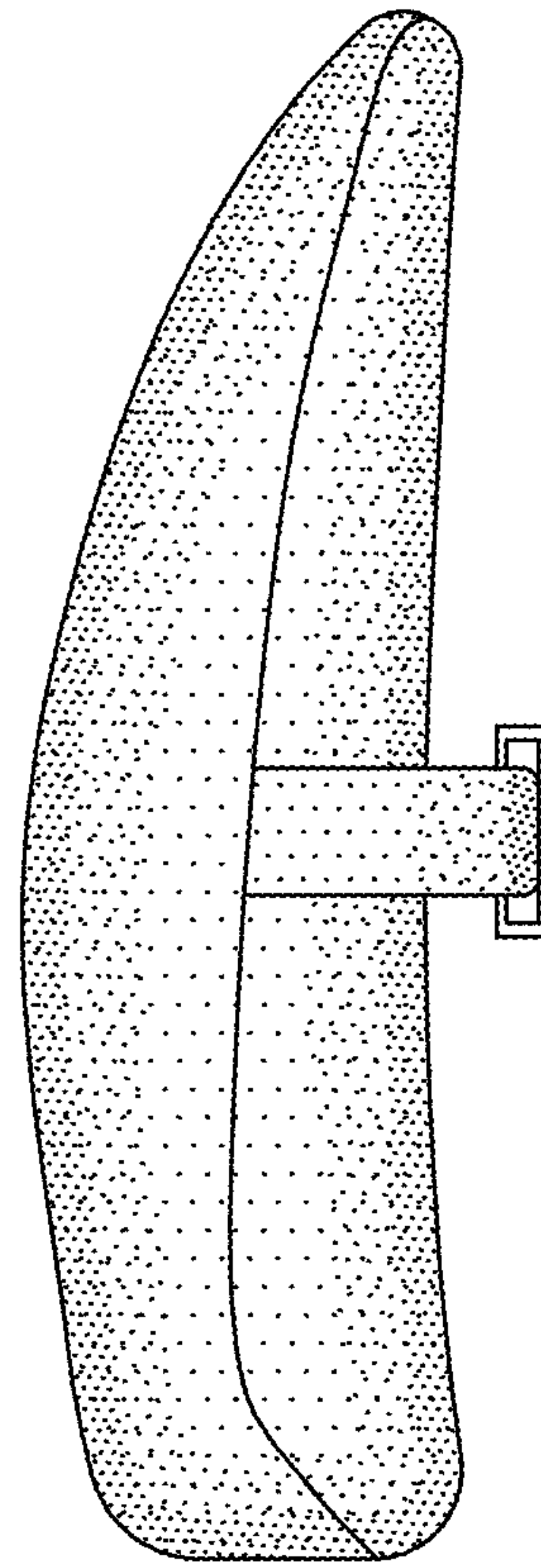

FIG.5

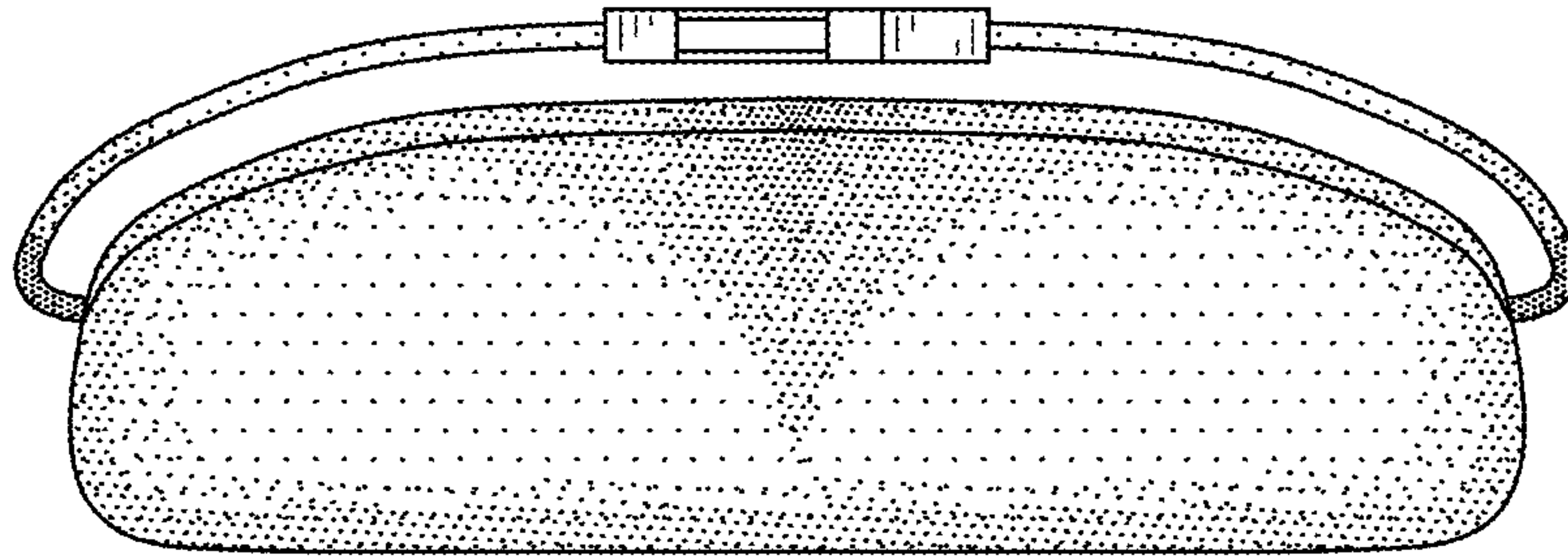

FIG. 6

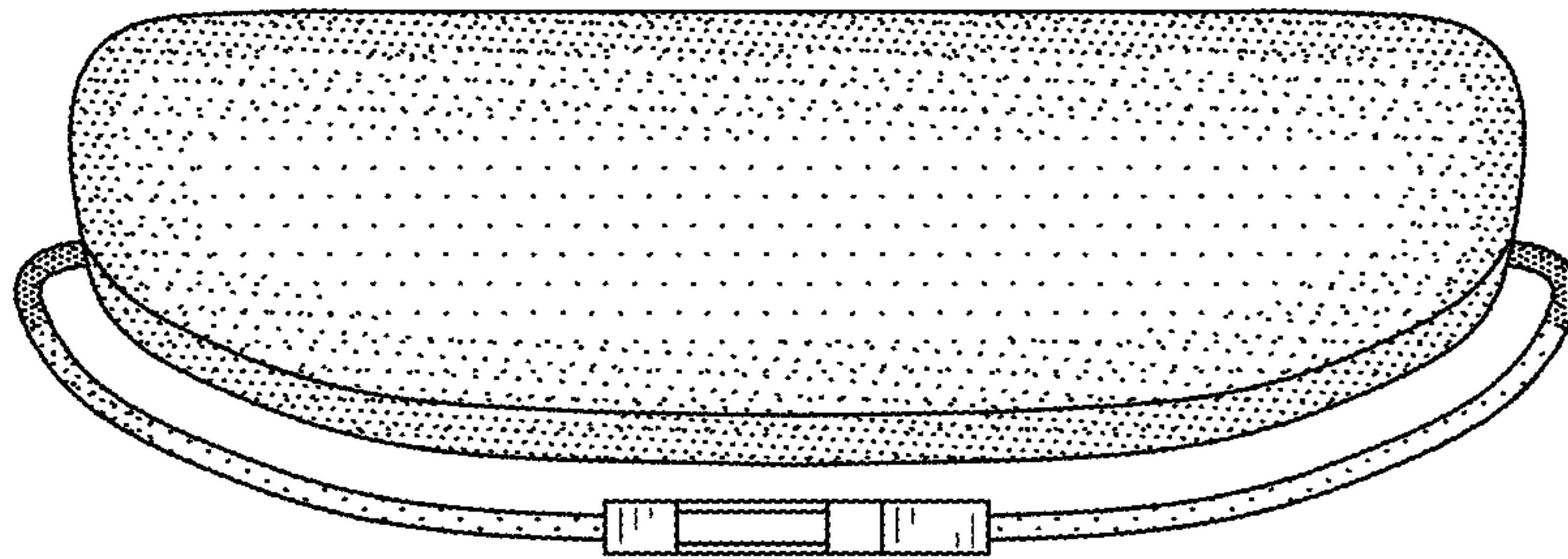

FIG. 7