



US00D790250S

(12) **United States Design Patent** (10) **Patent No.:** **US D790,250 S**
Hsu (45) **Date of Patent:** **** Jun. 27, 2017**

(54) **SOAP DISPENSER**

D560,087 S * 1/2008 Sellers D6/542
D622,526 S * 8/2010 Dai D6/542
D703,968 S * 5/2014 Hardy D6/542

(71) Applicant: **HOKWANG INDUSTRIES CO., LTD.**, New Taipei (TW)

* cited by examiner

(72) Inventor: **Chi-Chin Hsu**, New Taipei (TW)

Primary Examiner — Wan Laymon

(73) Assignee: **Hokwang Industries Co., Ltd.**, New Taipei (TW)

Assistant Examiner — Mark Booker

(74) *Attorney, Agent, or Firm* — Muncy, Geissler, Olds & Lowe, P.C.

(**) Term: **15 Years**

(21) Appl. No.: **29/562,922**

(57) **CLAIM**

(22) Filed: **Apr. 29, 2016**

The ornamental design for a “soap dispenser,” as shown and described.

(51) **LOC (10) Cl.** **23-02**

(52) **U.S. Cl.**
USPC **D6/542**

DESCRIPTION

(58) **Field of Classification Search**
USPC D6/542, 512, 524, 543, 544, 545, 538;
D9/291, 448, 449, 682, 688, 690, 691;
221/282; 222/14, 173, 146.3, 628, 251,
222/181.1, 181.3
CPC A47G 19/24; B67D 3/0029; B65D 23/003;
B65D 83/40; B65D 50/045; B05B
11/3001; F16N 3/10
See application file for complete search history.

FIG. 1 is a perspective view of a “soap dispenser” showing my new design;
FIG. 2 is a front side elevation view thereof;
FIG. 3 is a rear side elevation view thereof;
FIG. 4 is a left side elevation view thereof;
FIG. 5 is a right side elevation view thereof;
FIG. 6 is a top plan view thereof;
FIG. 7 is a bottom plan view thereof;
FIG. 8 is another perspective view thereof; and,
FIG. 9 is the illustration for the reference.
The broken line showing in the figures is included for the purpose of illustrating portions of the soap dispenser and form no part of the claimed design.

(56) **References Cited**

U.S. PATENT DOCUMENTS

D458,494 S * 6/2002 Cascio D6/538
D547,099 S * 7/2007 Williams D6/542

1 Claim, 9 Drawing Sheets

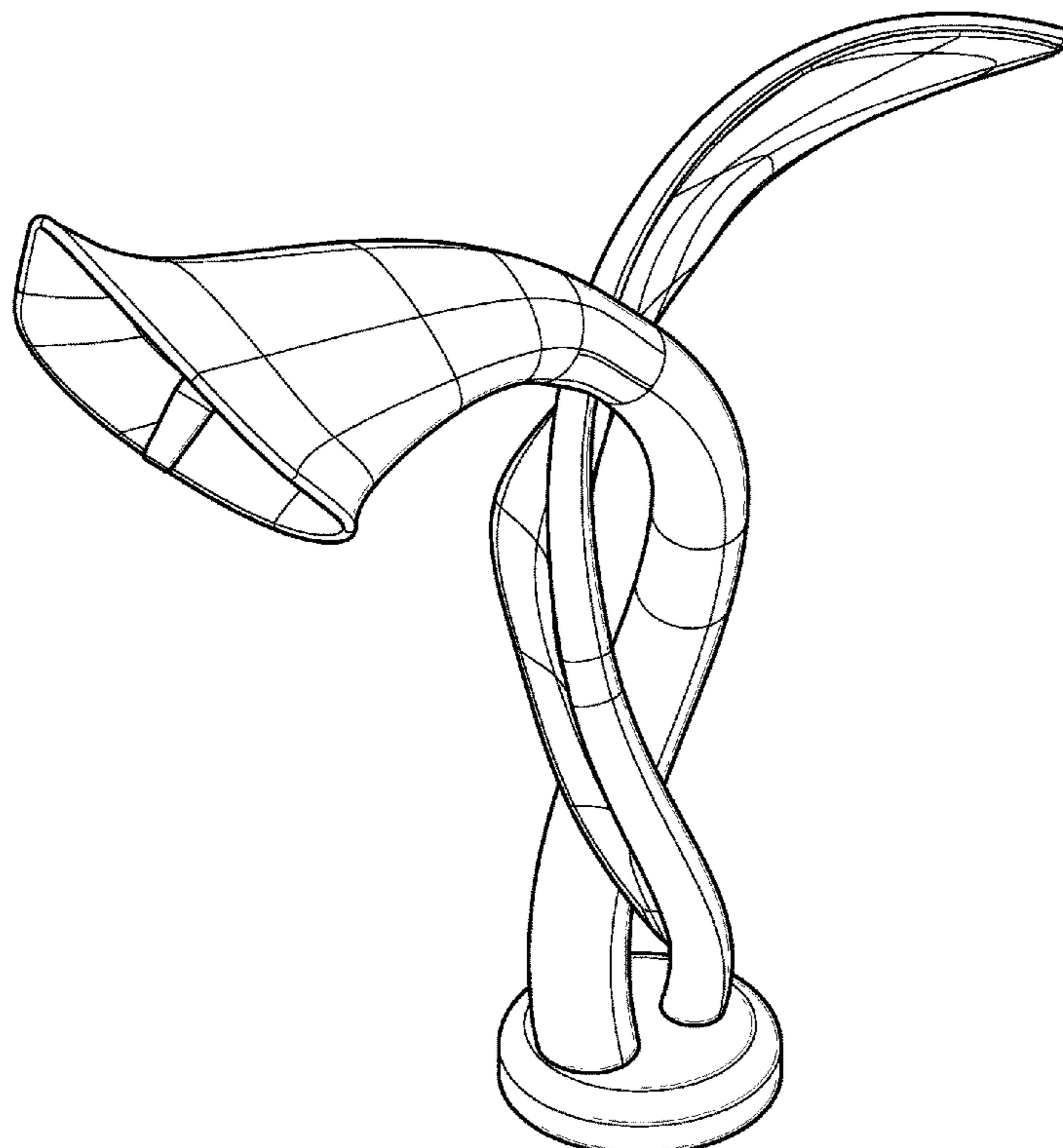

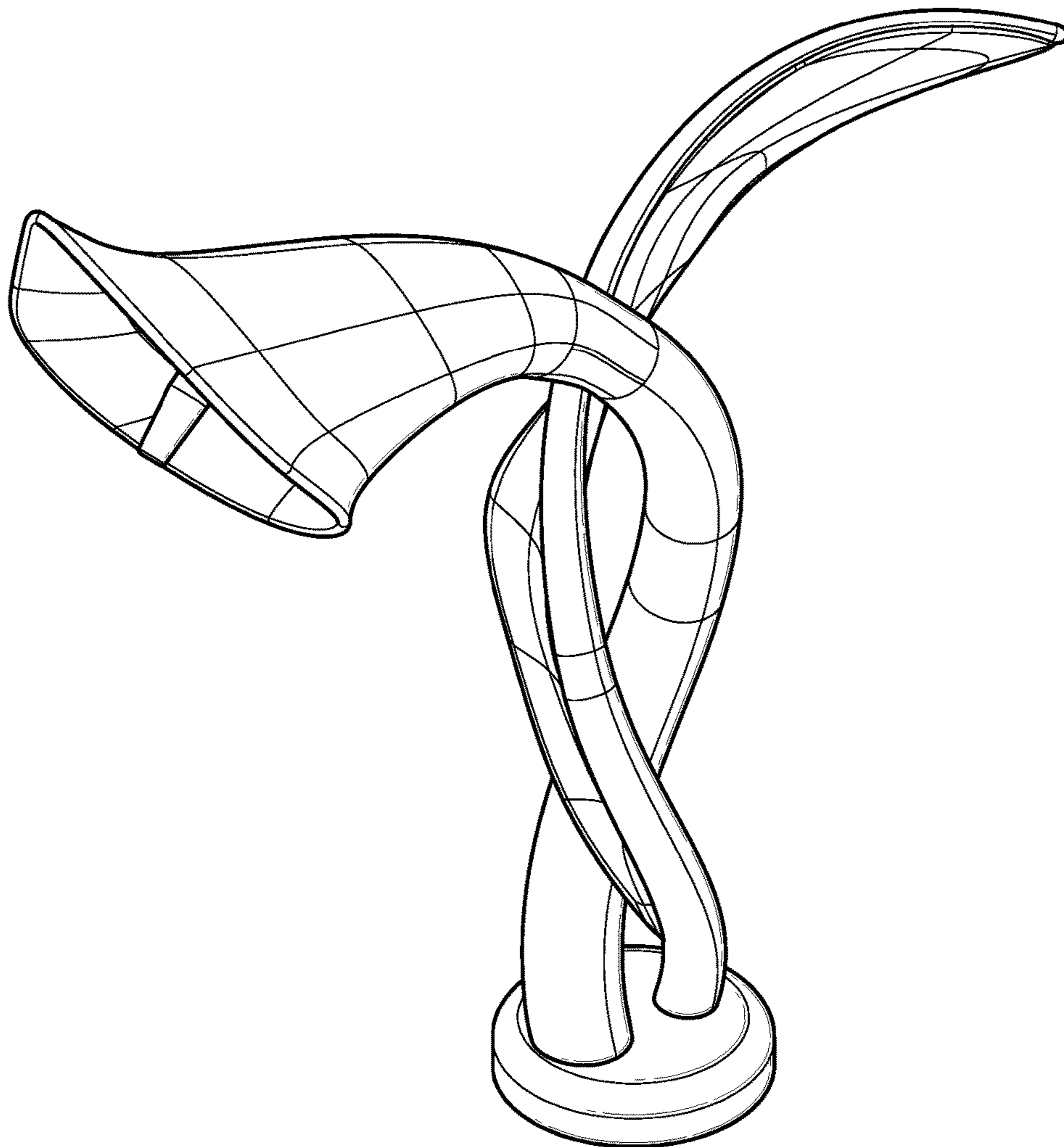

Fig. 1

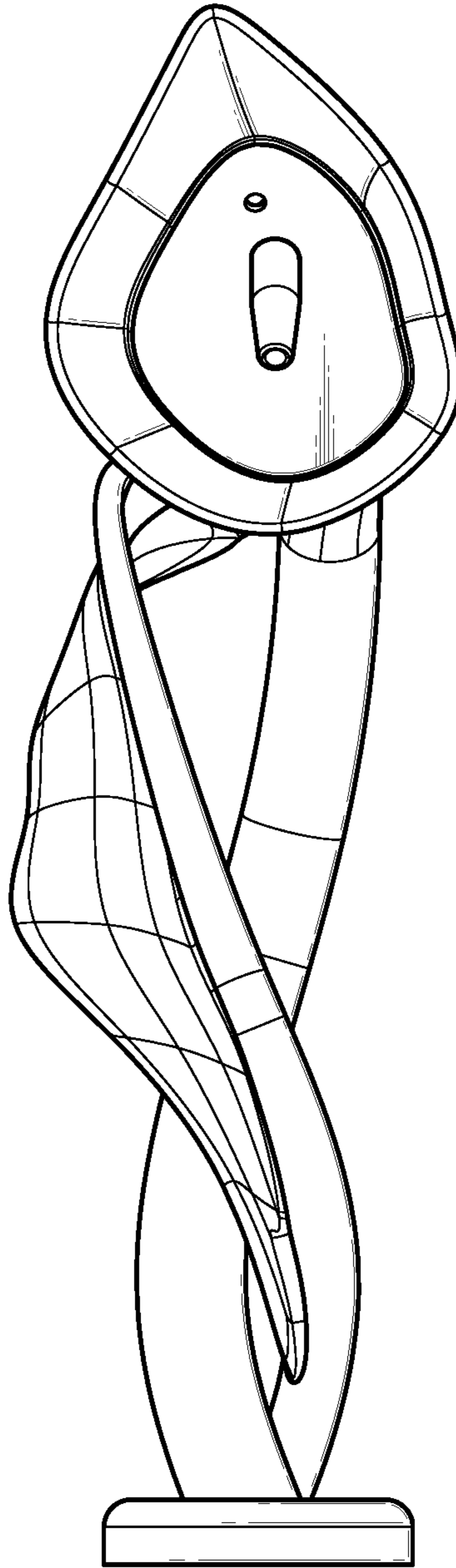

Fig. 2

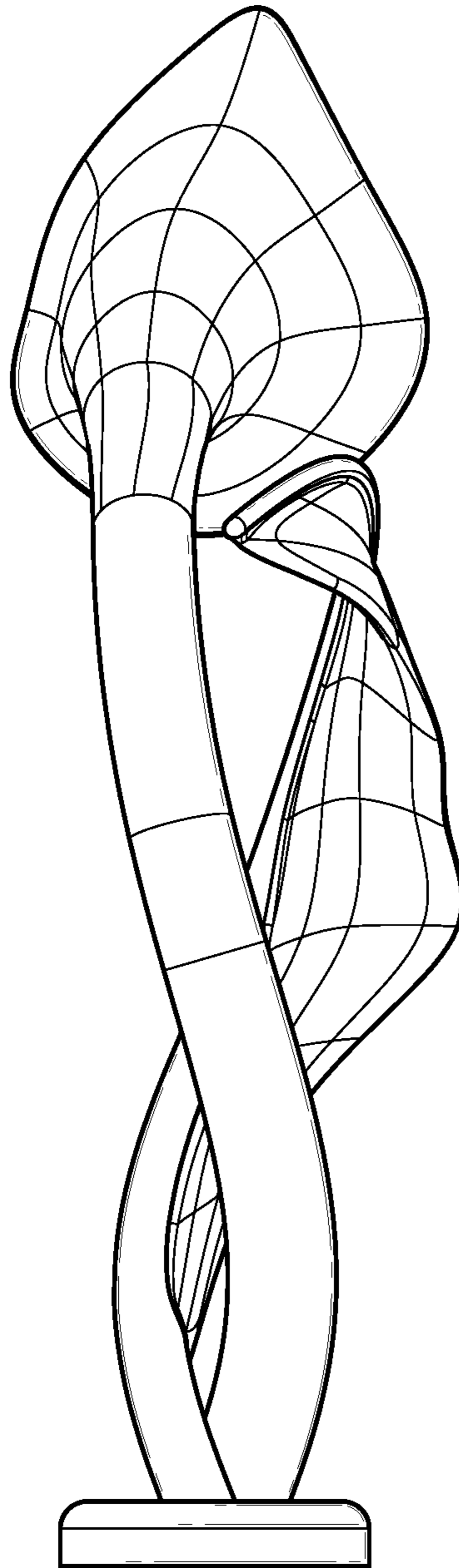

Fig. 3

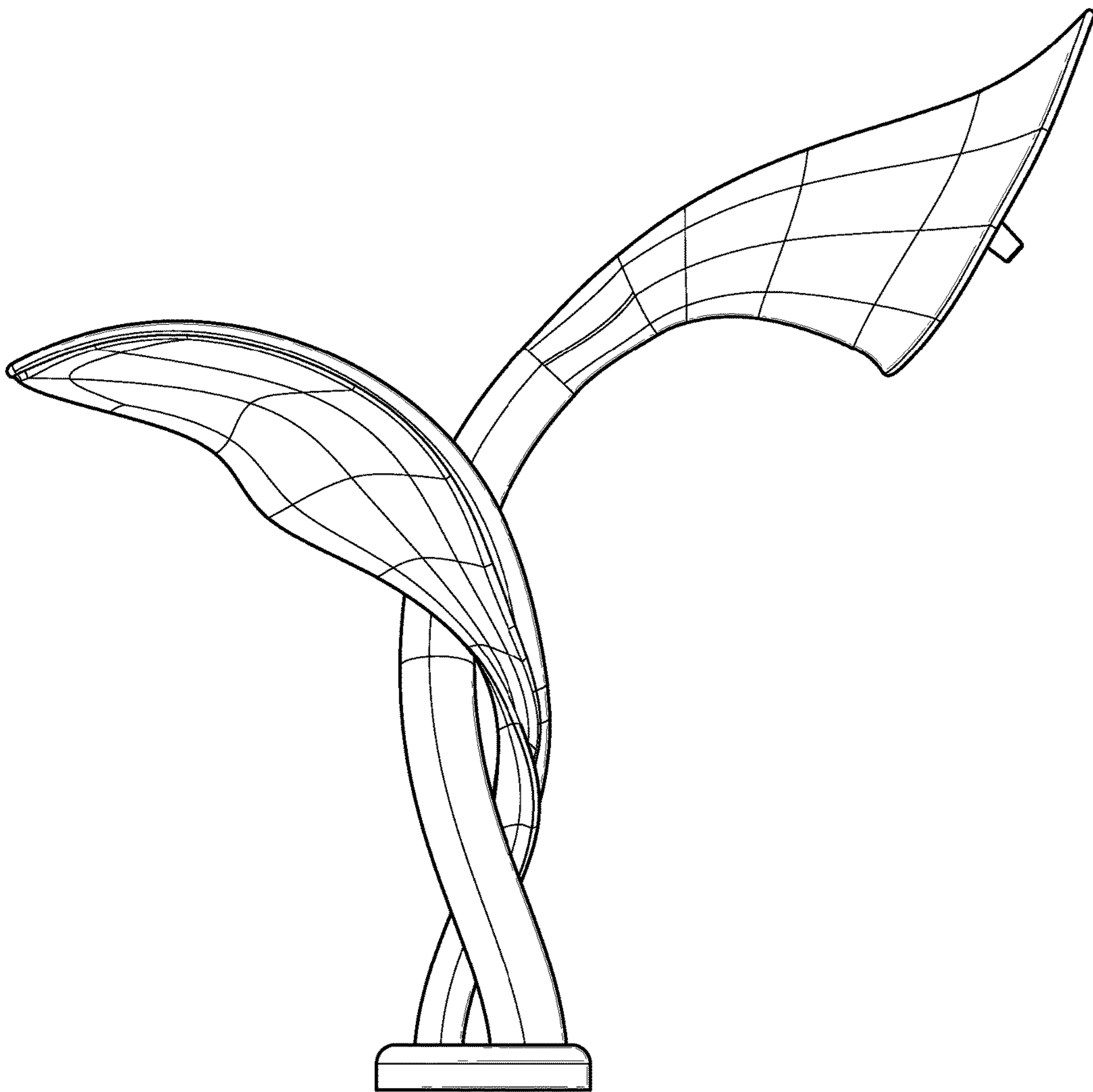

Fig. 4

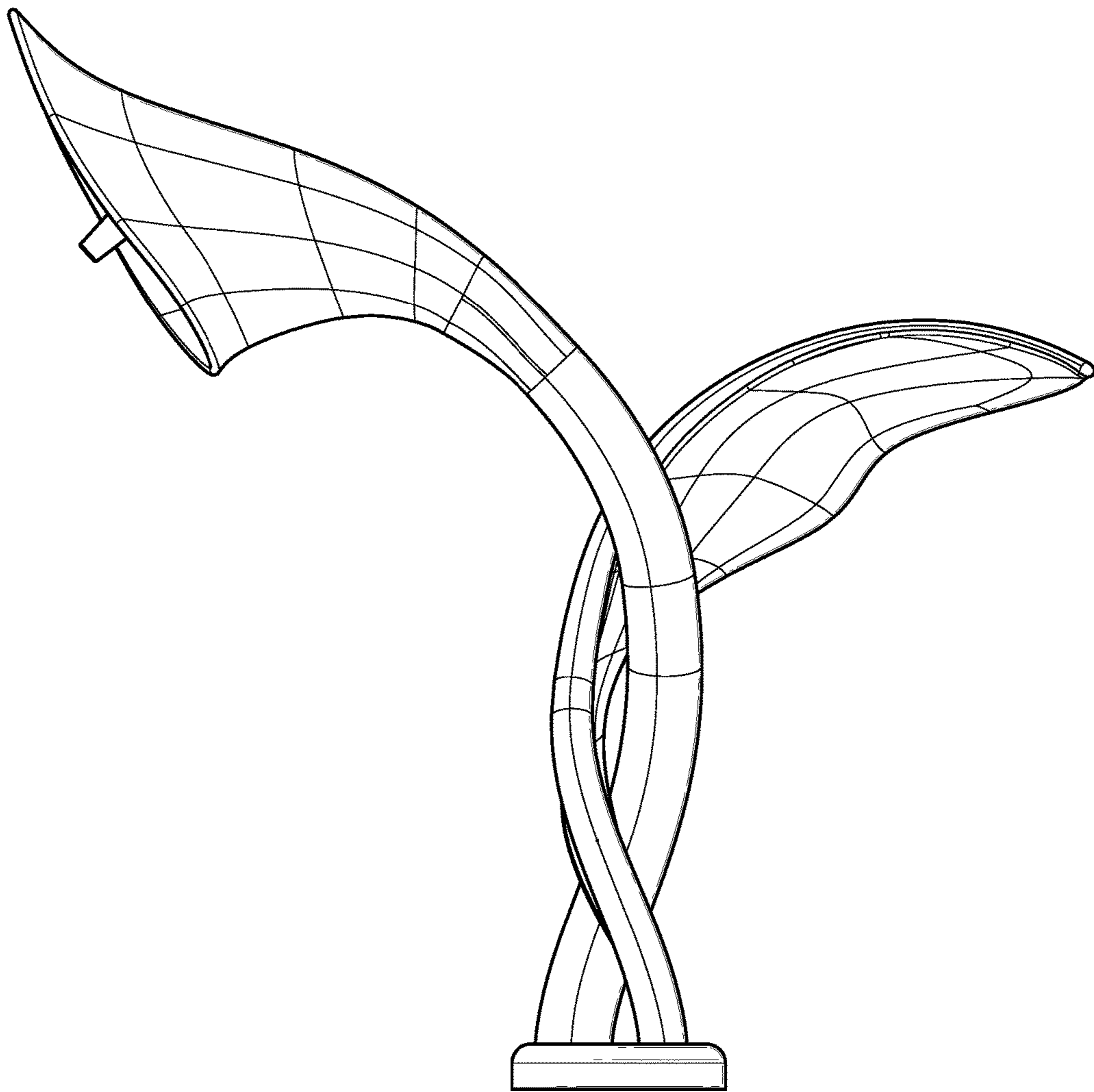

Fig. 5

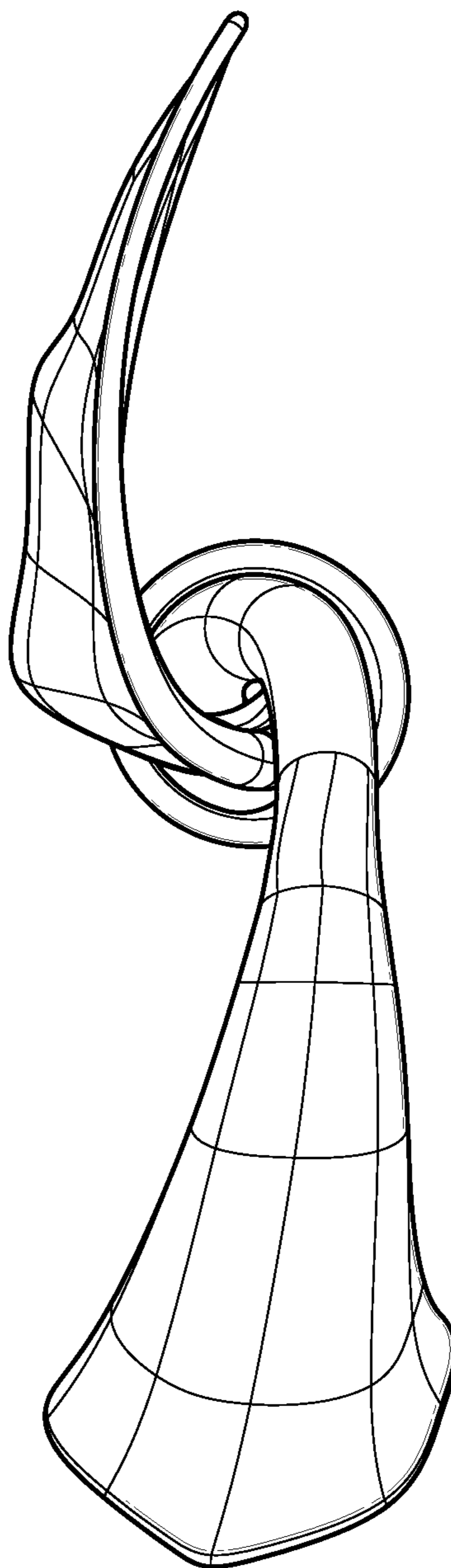

Fig. 6

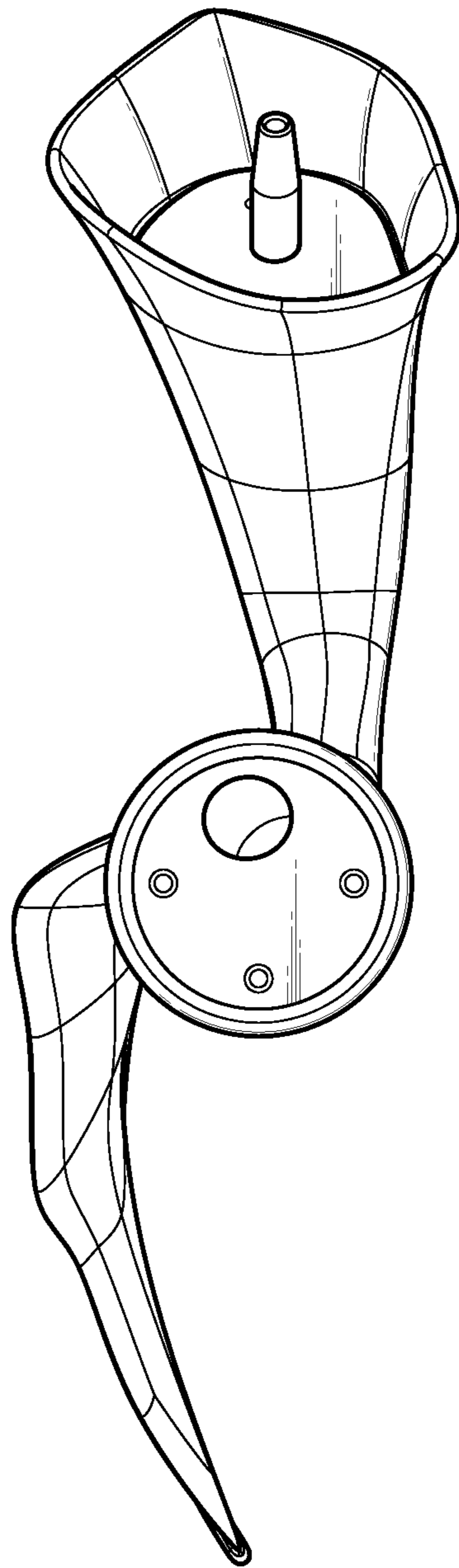

Fig. 7

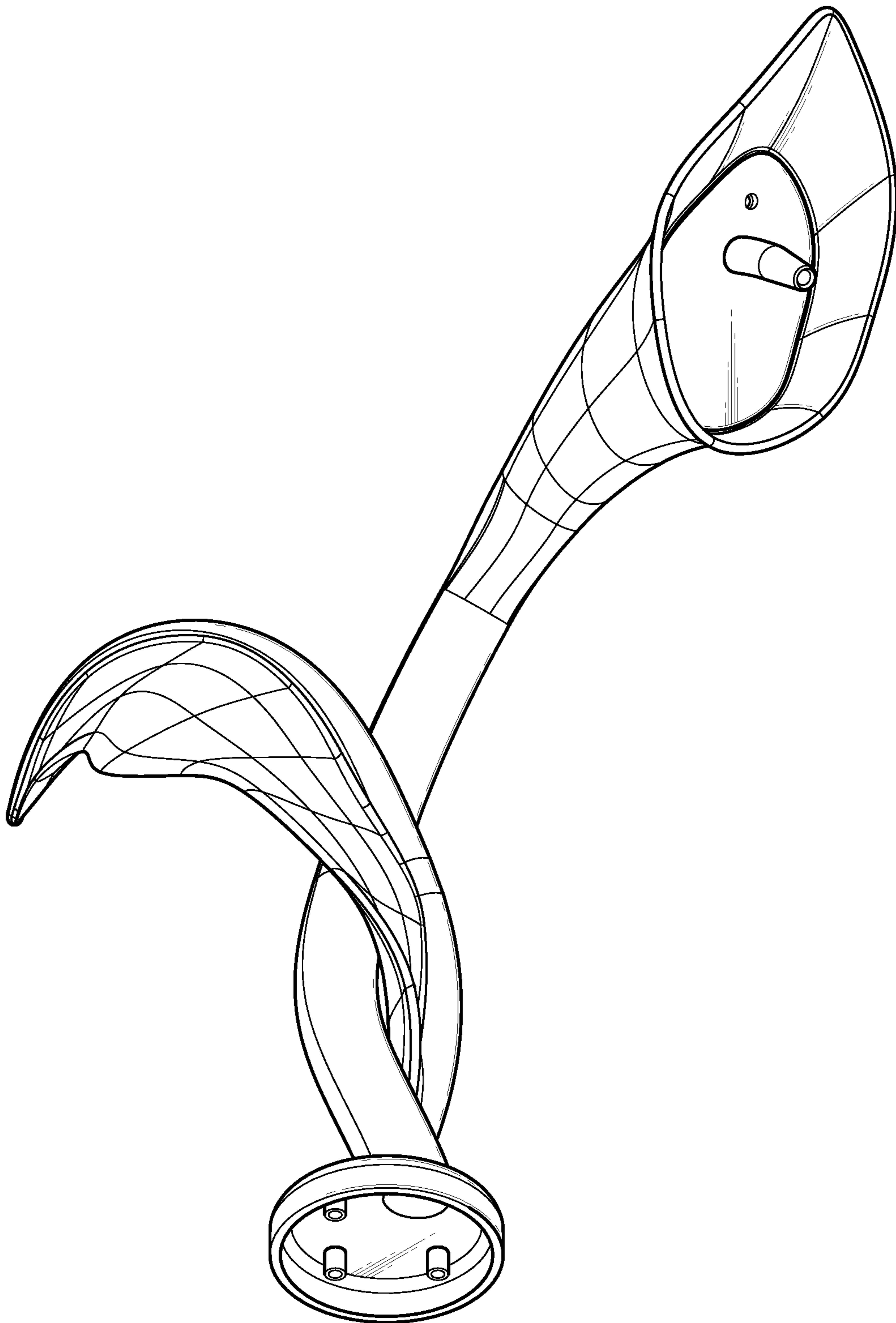

Fig. 8

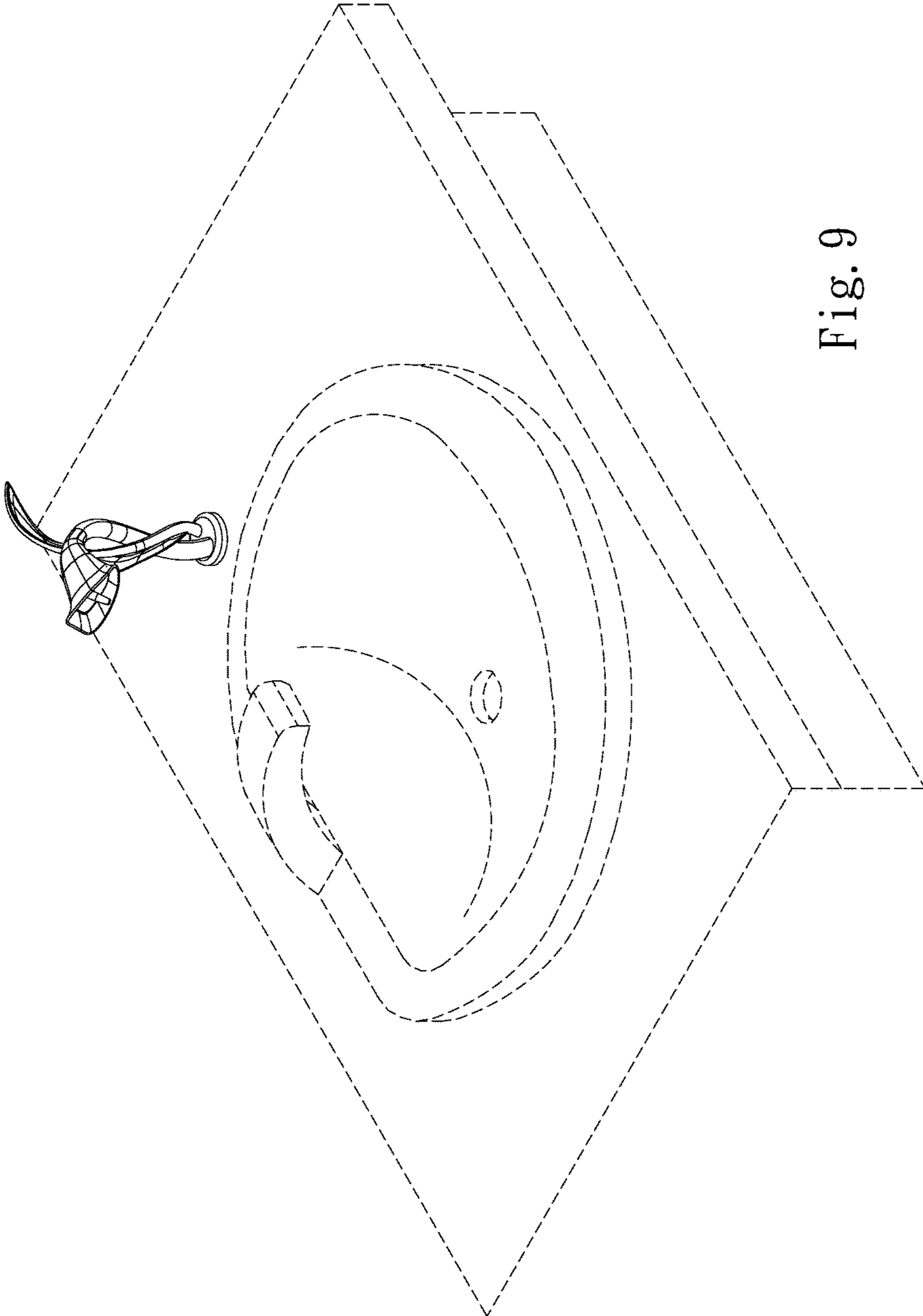

Fig. 9