



US00D790223S

(12) **United States Design Patent**  
**Drew et al.**

(10) **Patent No.:** **US D790,223 S**  
(45) **Date of Patent:** **\*\* Jun. 27, 2017**

(54) **BACKPACK STRAP**

(71) Applicant: **Target Brands, Inc.**, Minneapolis, MN (US)

(72) Inventors: **Jason V. Drew**, Shorewood, MN (US);  
**Christopher E. Svensrud**, Minneapolis, MN (US)

(73) Assignee: **Target Brands, Inc.**, Minneapolis, MN (US)

(\*\*) Term: **14 Years**

(21) Appl. No.: **29/523,801**

(22) Filed: **Apr. 14, 2015**

(51) **LOC (10) Cl.** ..... **03-01**

(52) **U.S. Cl.**  
USPC ..... **D3/327**

(58) **Field of Classification Search**  
USPC ..... D3/301, 318, 327, 213–217; 224/101,  
224/153, 578, 604–607, 616–618, 627  
(Continued)

(56) **References Cited**

U.S. PATENT DOCUMENTS

3,549,064 A 12/1970 Wilson  
4,066,195 A \* 1/1978 Dickler ..... A45C 13/18  
190/101

(Continued)

*Primary Examiner* — Susan Bennett Hattan

*Assistant Examiner* — Rebecca Tsehaye

(74) *Attorney, Agent, or Firm* — Leanne Taveggia Farrell;  
Westman, Champlin & Koehler, P.A.

(57) **CLAIM**

The ornamental design for a backpack strap, as shown and described.

**DESCRIPTION**

FIG. 1 is a perspective view of a first embodiment of a backpack strap with environment showing our new design;

FIG. 2 is an enlarged perspective view of FIG. 1 with a portion of environment removed;  
FIG. 3 is a left side view of FIG. 2;  
FIG. 4 is a right side view of FIG. 2;  
FIG. 5 is a front view of FIG. 2;  
FIG. 6 is a back view of FIG. 2;  
FIG. 7 is a top view of FIG. 2;  
FIG. 8 is a bottom view of FIG. 2;  
FIG. 9 is a perspective view of an alternate position of the first embodiment with environment;  
FIG. 10 is an enlarged perspective view of FIG. 9 with a portion of environment removed;  
FIG. 11 is a left side view of FIG. 10;  
FIG. 12 is a right side view of FIG. 10;  
FIG. 13 is a front view of FIG. 10;  
FIG. 14 is a back view of FIG. 10;  
FIG. 15 is a top view of FIG. 10;  
FIG. 16 is a bottom view of FIG. 10;  
FIG. 17 is a perspective view of a second embodiment of a backpack strap with environment;  
FIG. 18 is an enlarged perspective view of FIG. 17 with a portion of environment removed;  
FIG. 19 is a left side view of FIG. 17;  
FIG. 20 is a right side view of FIG. 17;  
FIG. 21 is a front view of FIG. 17;  
FIG. 22 is a back view of FIG. 17;  
FIG. 23 is a top view of FIG. 17;  
FIG. 24 is a bottom view of FIG. 17;  
FIG. 25 is a perspective view of an alternate position of the second embodiment with environment;  
FIG. 26 is an enlarged perspective view of FIG. 25 with a portion of environment removed;  
FIG. 27 is a left side view of FIG. 25;  
FIG. 28 is a right side view of FIG. 25;  
FIG. 29 is a front view of FIG. 25;  
FIG. 30 is a back view of FIG. 25;  
FIG. 31 is a top view of FIG. 25;  
FIG. 32 is a bottom view of FIG. 25;  
FIG. 33 is a perspective view of a third embodiment of a backpack strap with environment;  
FIG. 34 is an enlarged perspective view of FIG. 33 with a portion of environment removed;  
FIG. 35 is a left side view of FIG. 34;  
FIG. 36 is a right side view of FIG. 34;

(Continued)

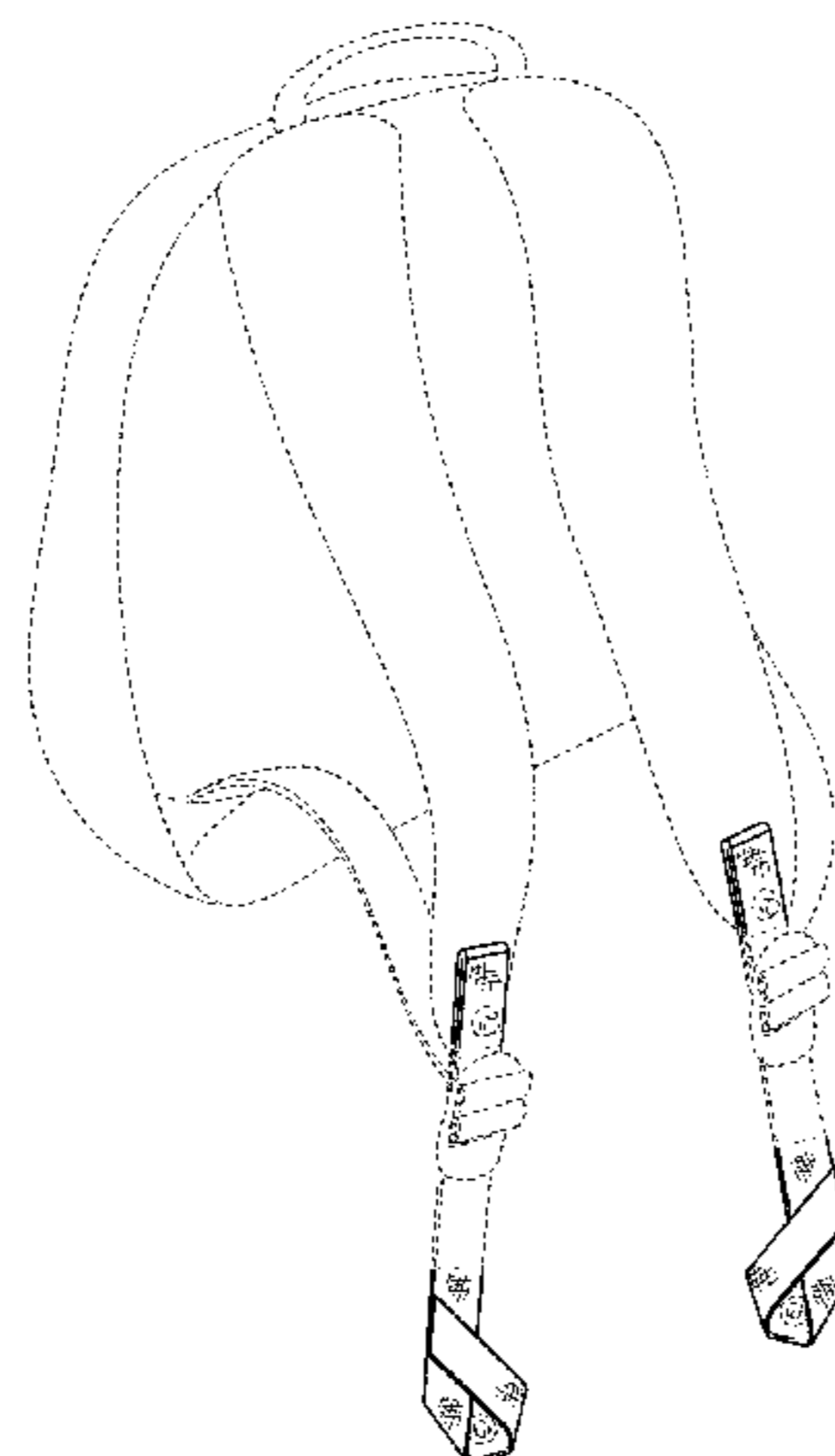

FIG. 37 is a front view of FIG. 34;  
 FIG. 38 is a back view of FIG. 34;  
 FIG. 39 is a top view of FIG. 34;  
 FIG. 40 is a bottom view of FIG. 34;  
 FIG. 41 is a perspective view of an alternate position of the third embodiment with environment;  
 FIG. 42 is an enlarged perspective view of FIG. 41 with a portion of environment removed;  
 FIG. 43 is a left side view of FIG. 42;  
 FIG. 44 is a right side view of FIG. 42;  
 FIG. 45 is a front view of FIG. 42;  
 FIG. 46 is a back view of FIG. 42;  
 FIG. 47 is a top view of FIG. 42; and,  
 FIG. 48 is a bottom view of FIG. 42.  
 The broken lines illustrate environment or portions of the backpack strap and form no part of the claimed design.

**1 Claim, 40 Drawing Sheets**

(58) **Field of Classification Search**  
 CPC ..... A45C 13/18; A45C 13/30; B63C 11/30;  
 A45F 3/04; A45F 3/047; A45F 3/042  
 See application file for complete search history.

(56)

**References Cited**

U.S. PATENT DOCUMENTS

4,982,885	A	1/1991	Severson et al.	
5,458,267	A	10/1995	Curtis et al.	
5,632,429	A *	5/1997	Cantwell .....	A45C 13/30 224/264
6,318,612	B1	11/2001	MacNeil	
6,431,315	B1	8/2002	Lewis	
6,557,218	B2	5/2003	Kipperman	
6,592,012	B2 *	7/2003	Godshaw .....	A45F 3/04 190/115
6,779,201	B1	8/2004	Pfrommer	
7,195,529	B1	3/2007	Crandall	
D576,789	S *	9/2008	Mayer .....	D3/215
7,465,125	B1 *	12/2008	Carmichael .....	B63C 11/30 2/311
D632,887	S *	2/2011	Jones .....	D3/214
D635,761	S *	4/2011	Hedaya .....	D3/216
D669,257	S *	10/2012	Hedaya .....	D3/216
D745,263	S *	12/2015	Tagle .....	D3/213
D772,577	S *	11/2016	Muchin .....	D3/327
D774,769	S *	12/2016	Guthrie .....	D3/318
2004/0000570	A1	1/2004	Forsman	
2008/0127461	A1	6/2008	Linden et al.	
2014/0131401	A1	5/2014	Workman	

\* cited by examiner

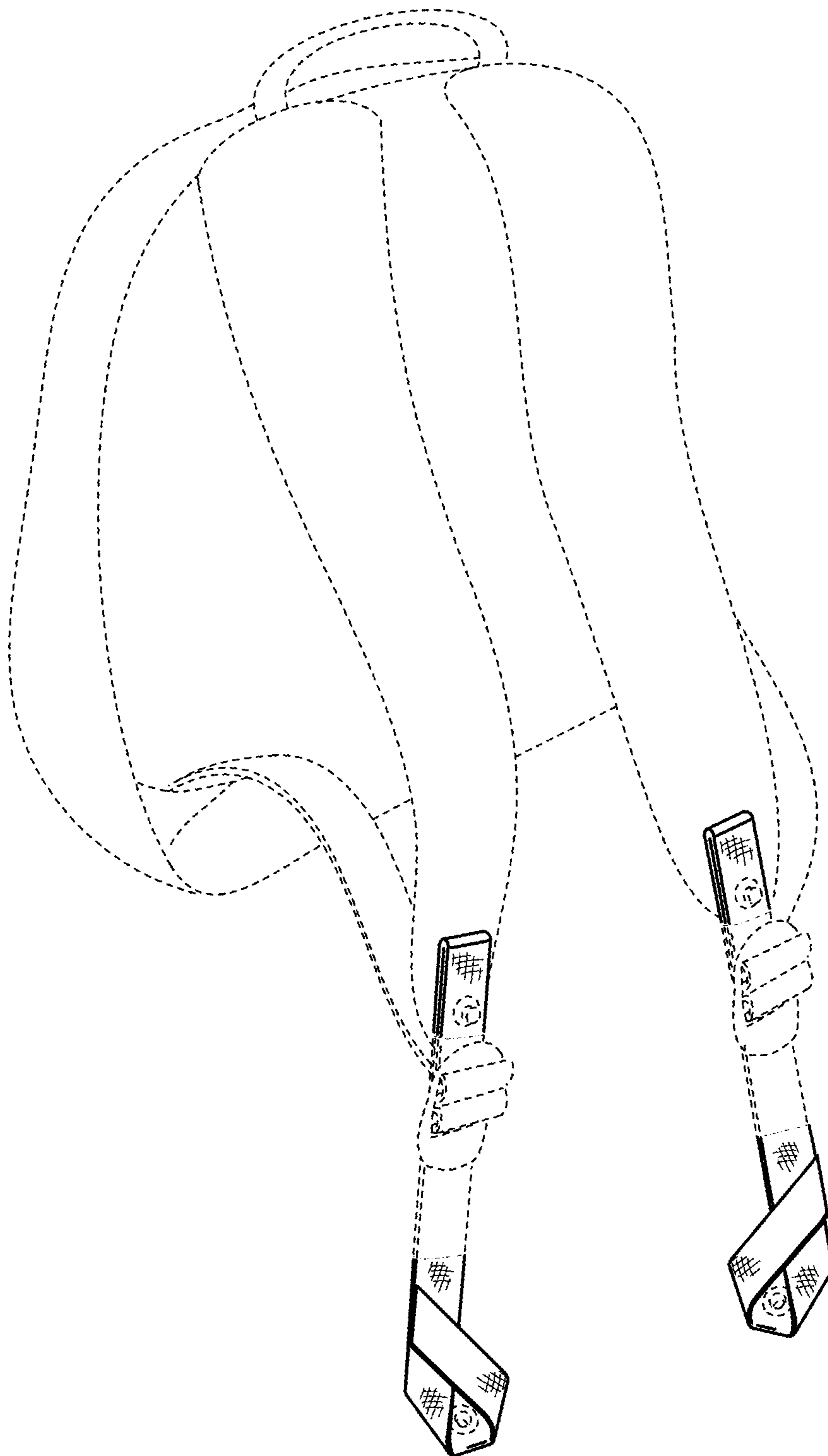

FIG. 1

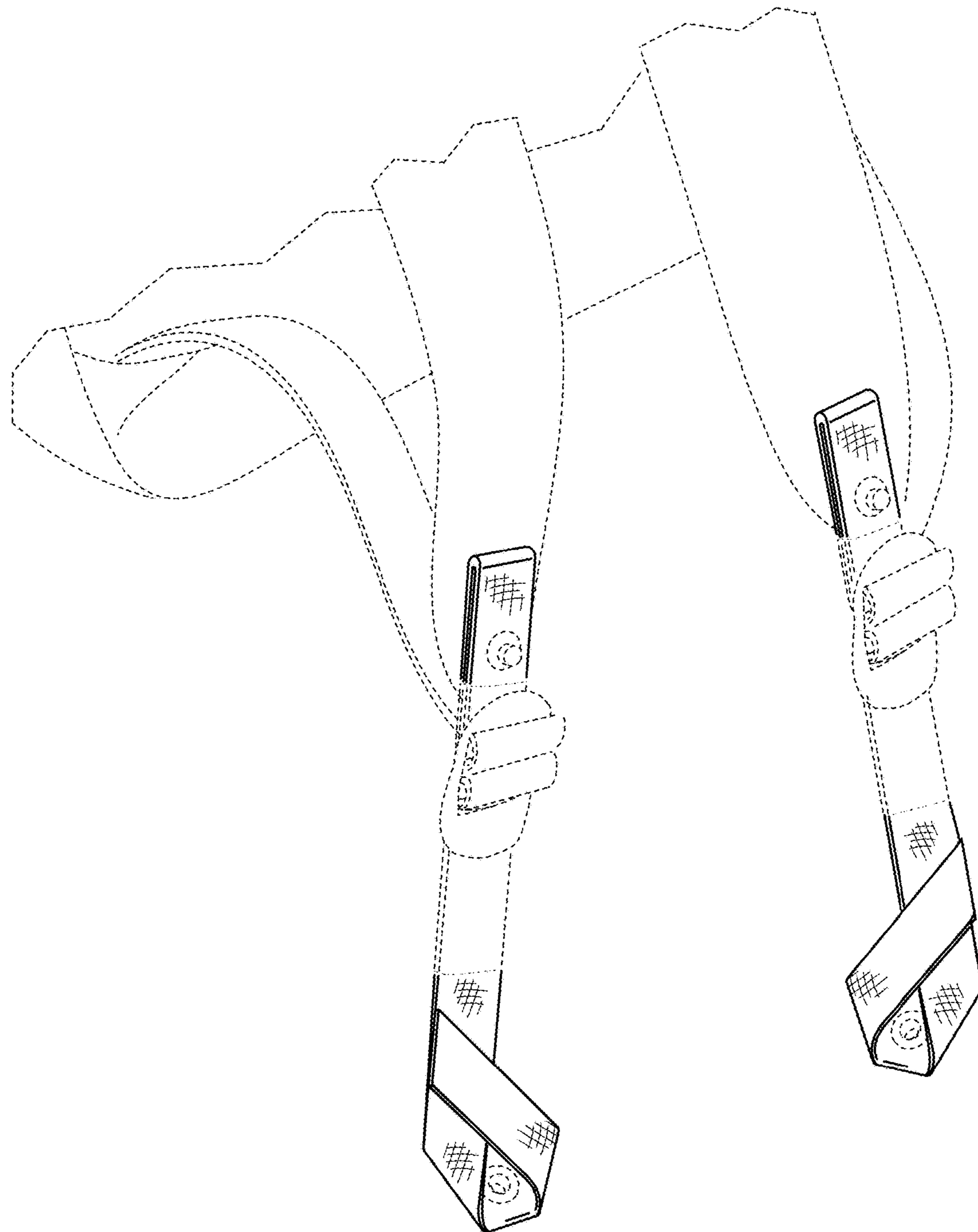

FIG. 2

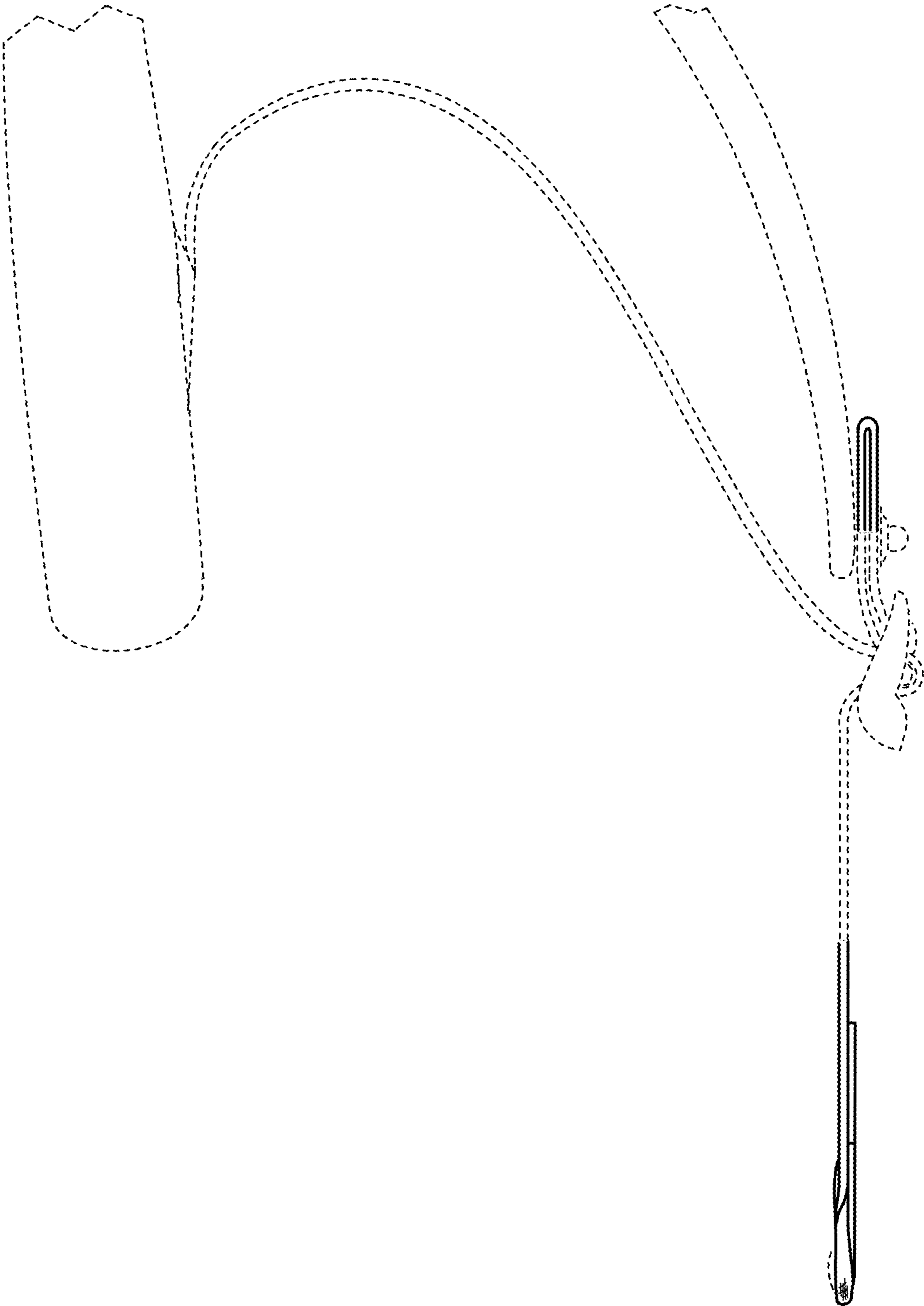

FIG. 3

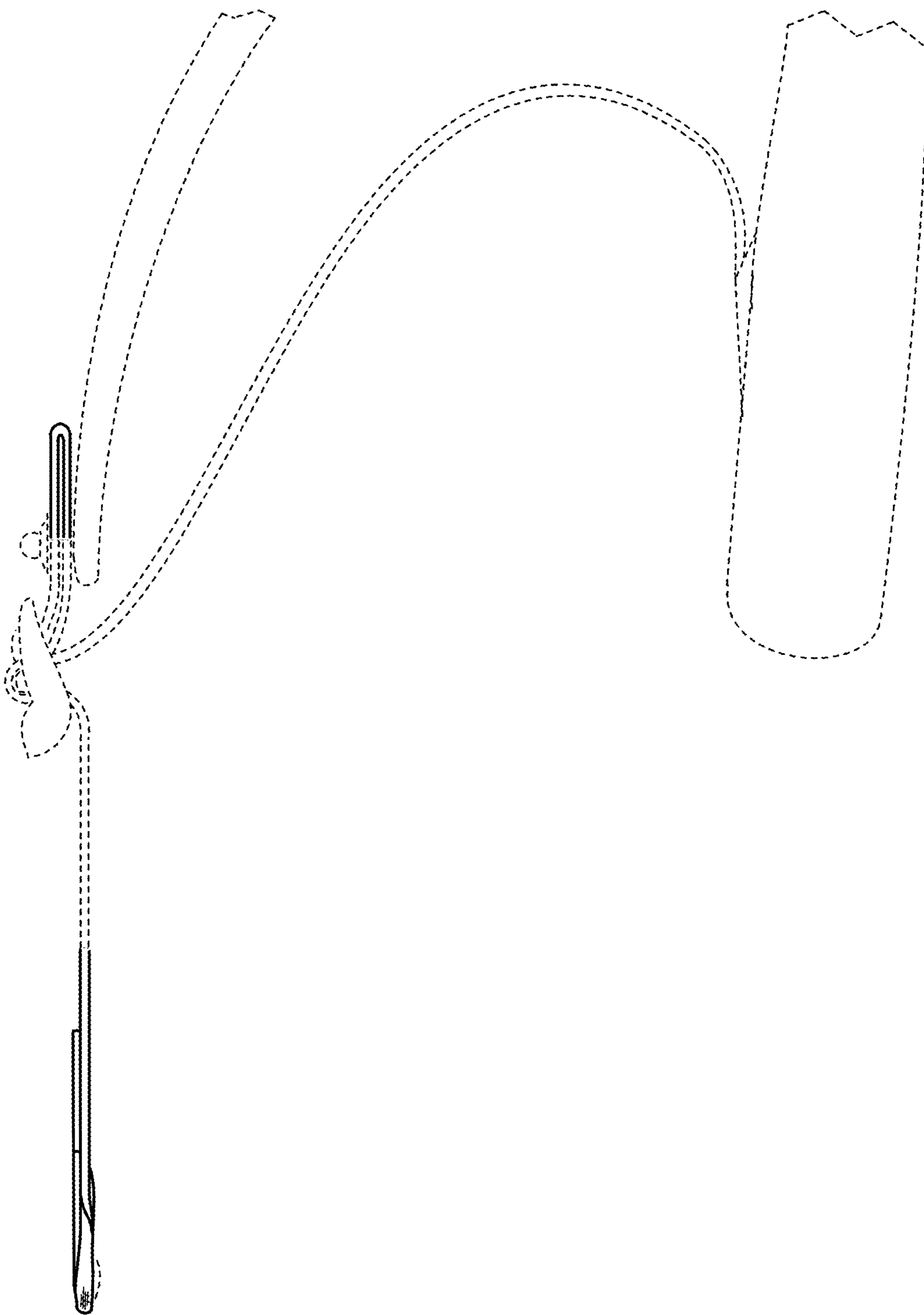

FIG. 4

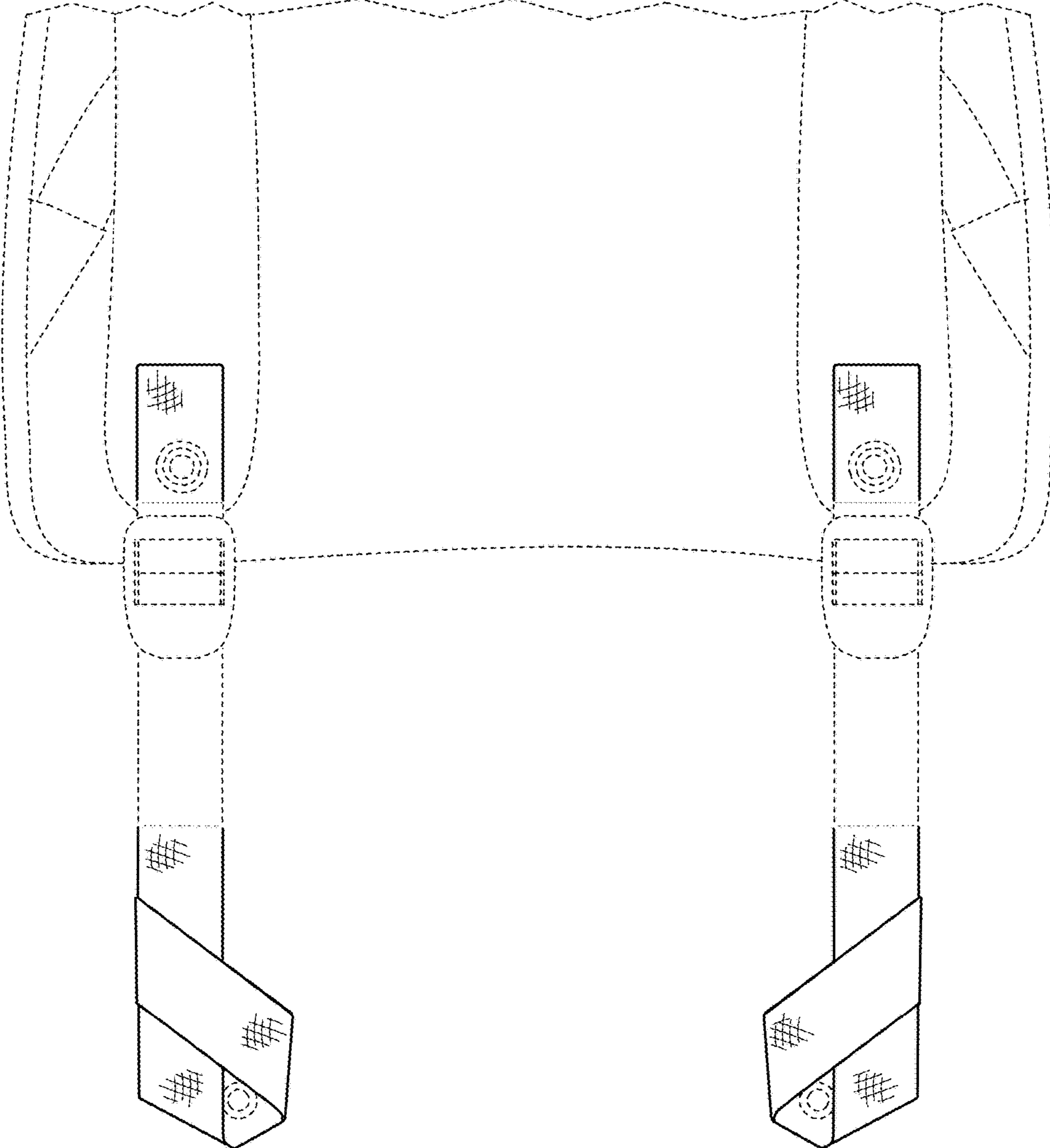

FIG. 5

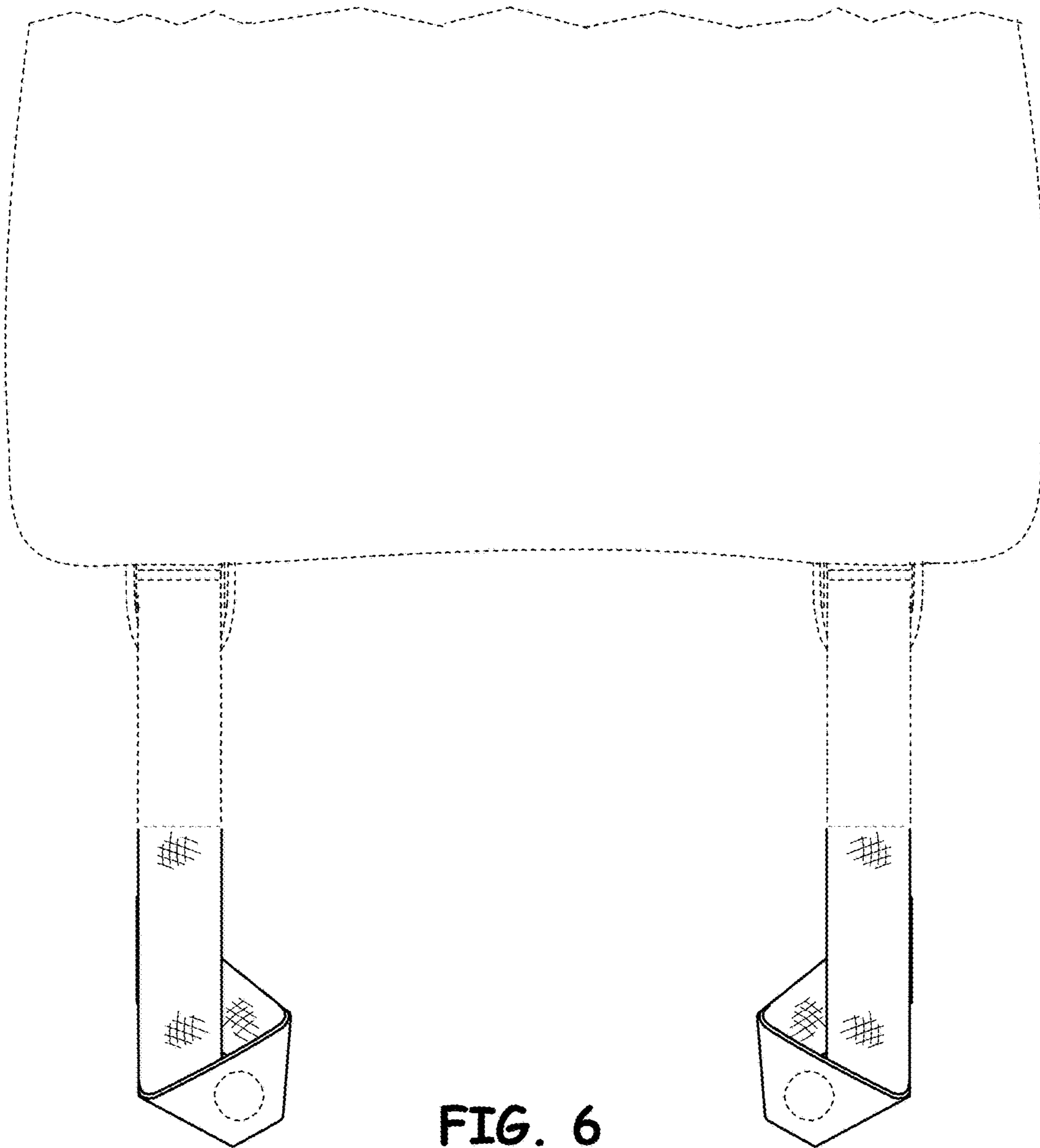

FIG. 6



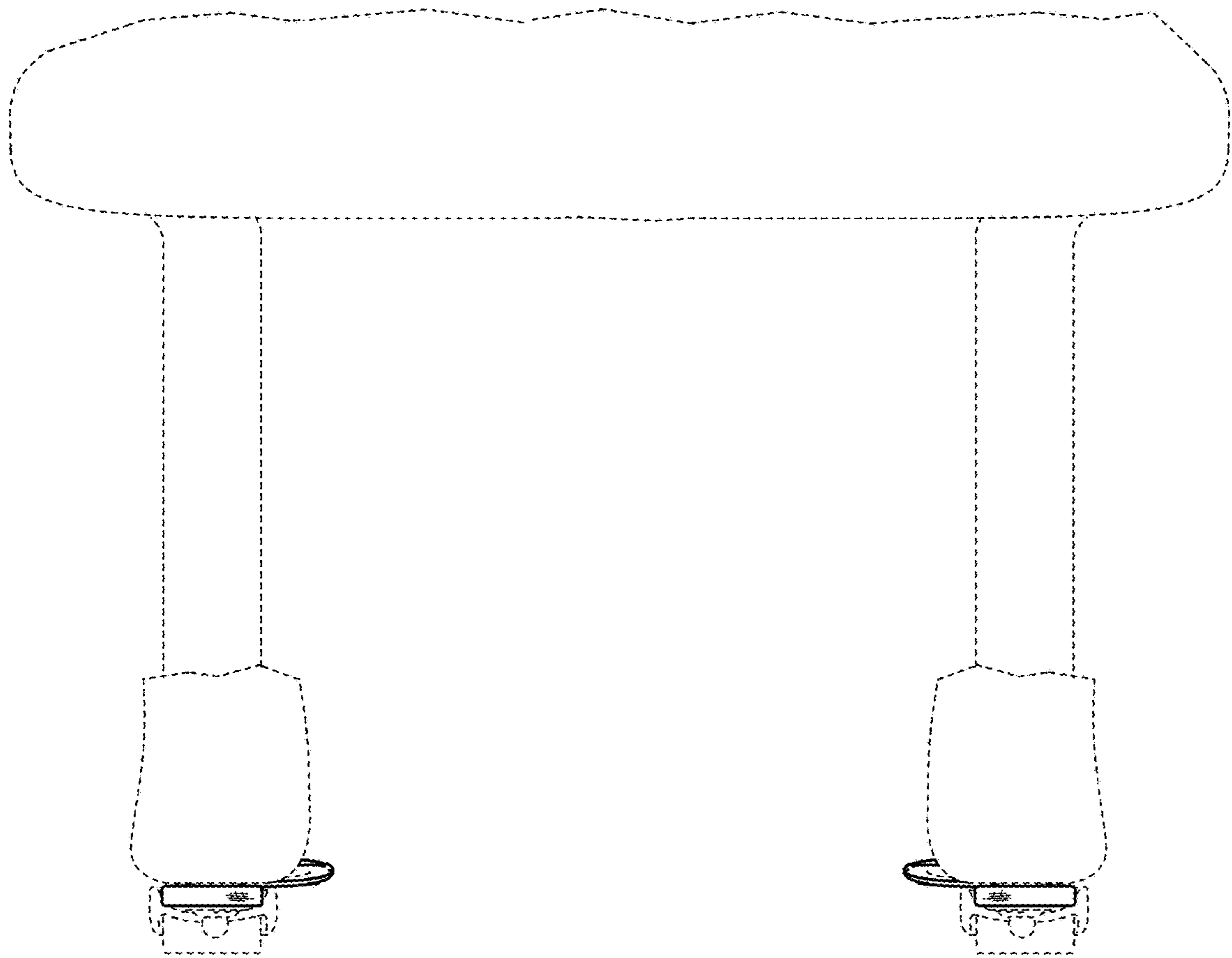

FIG. 7

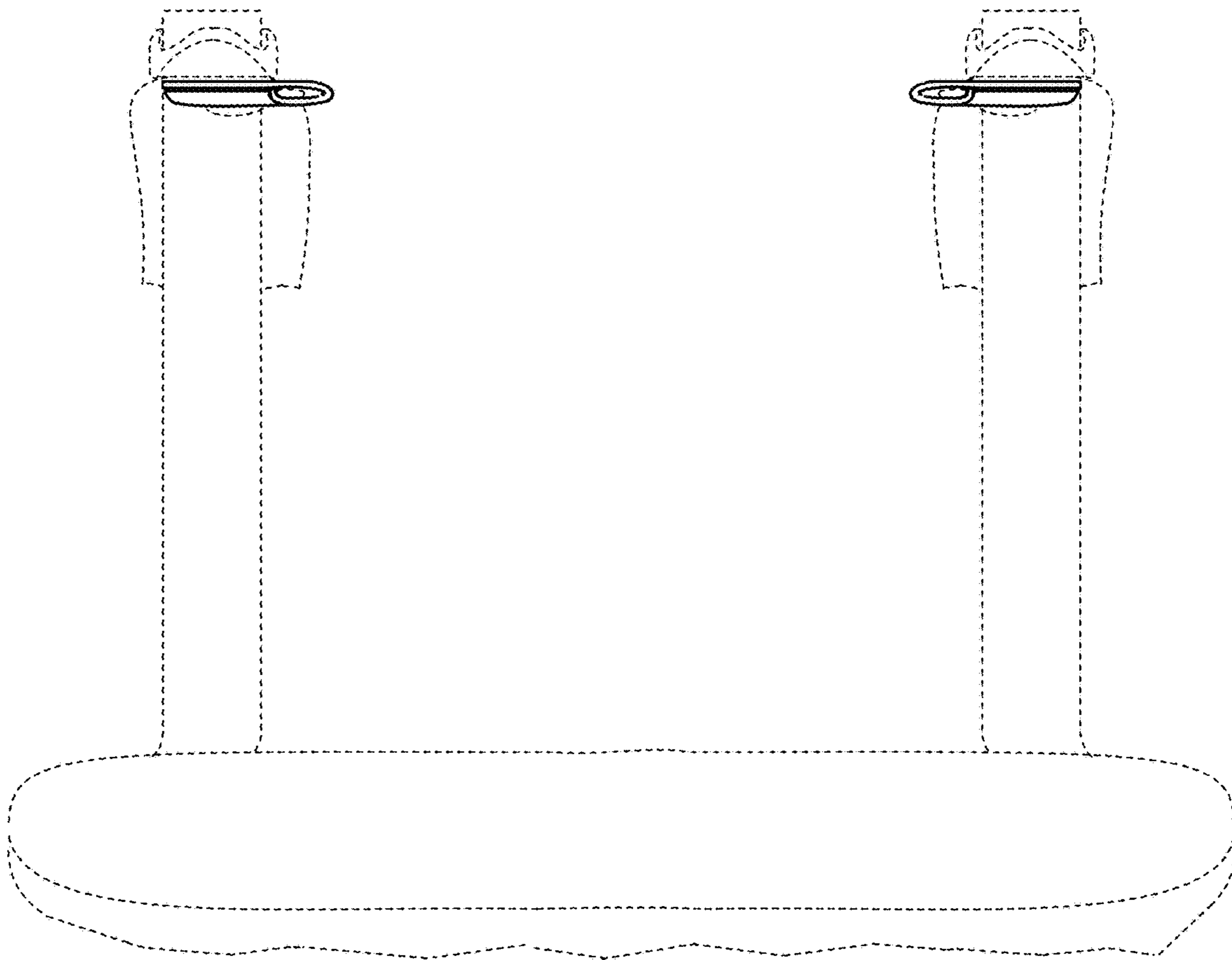

FIG. 8

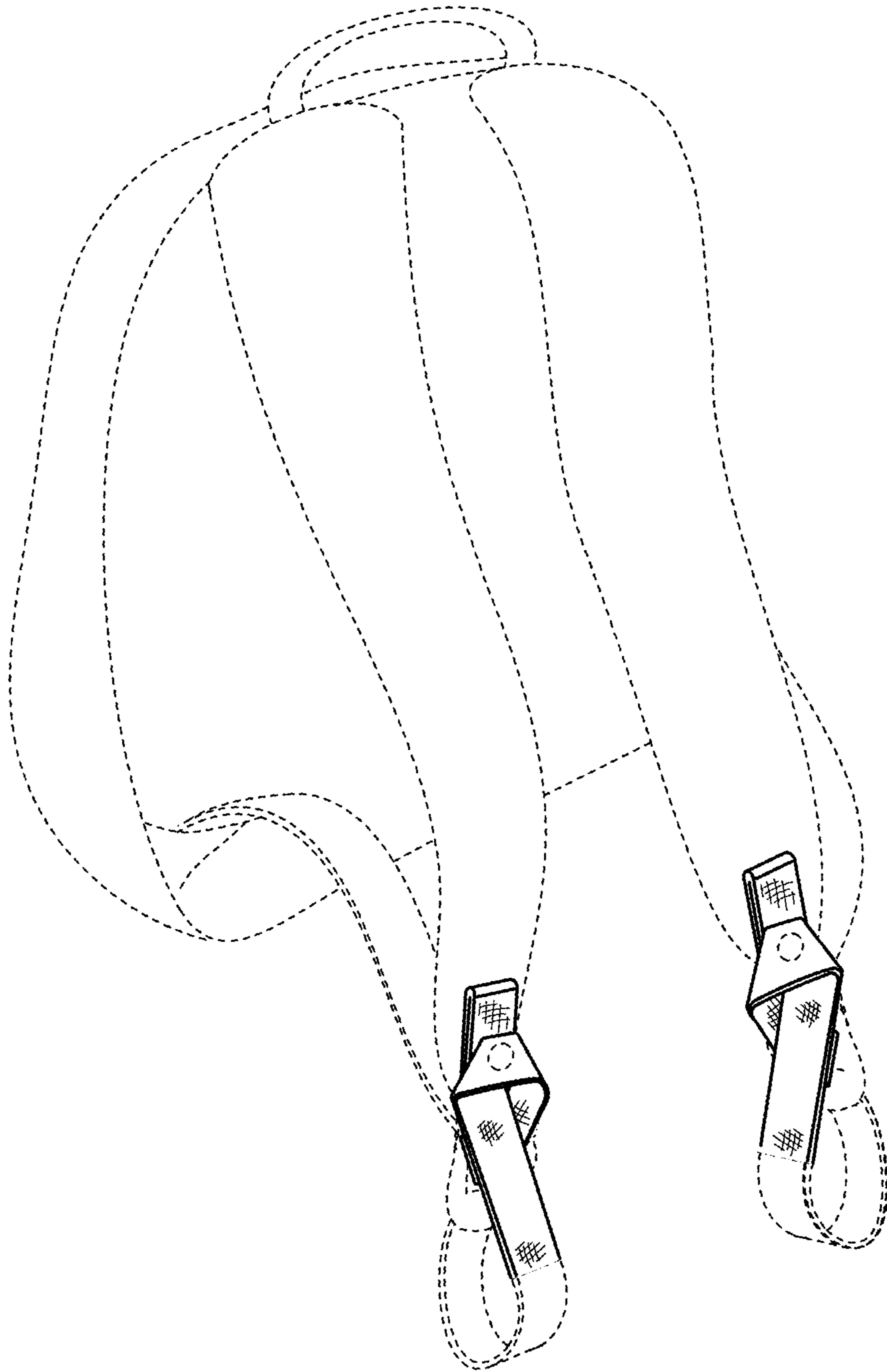

FIG. 9

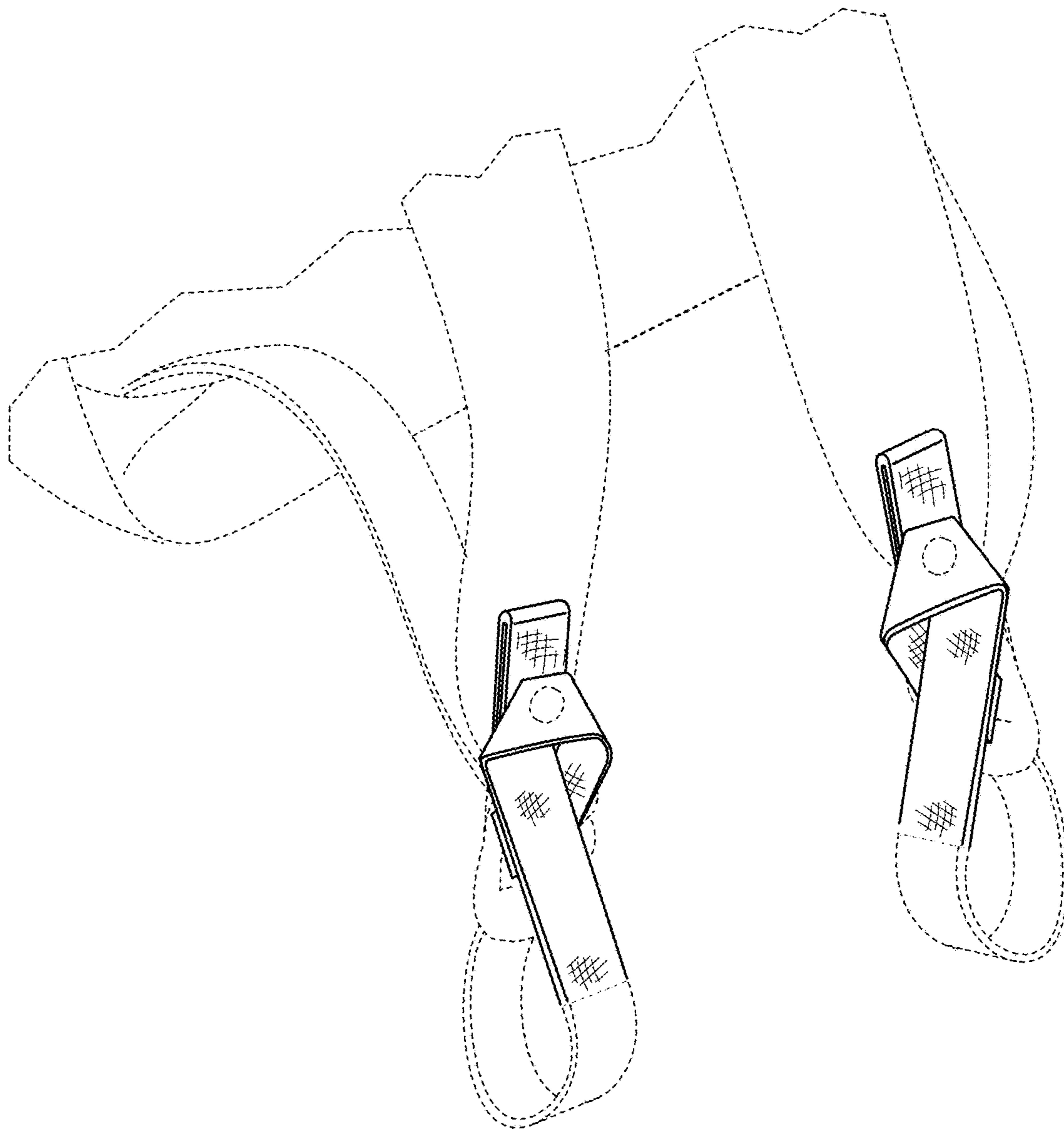
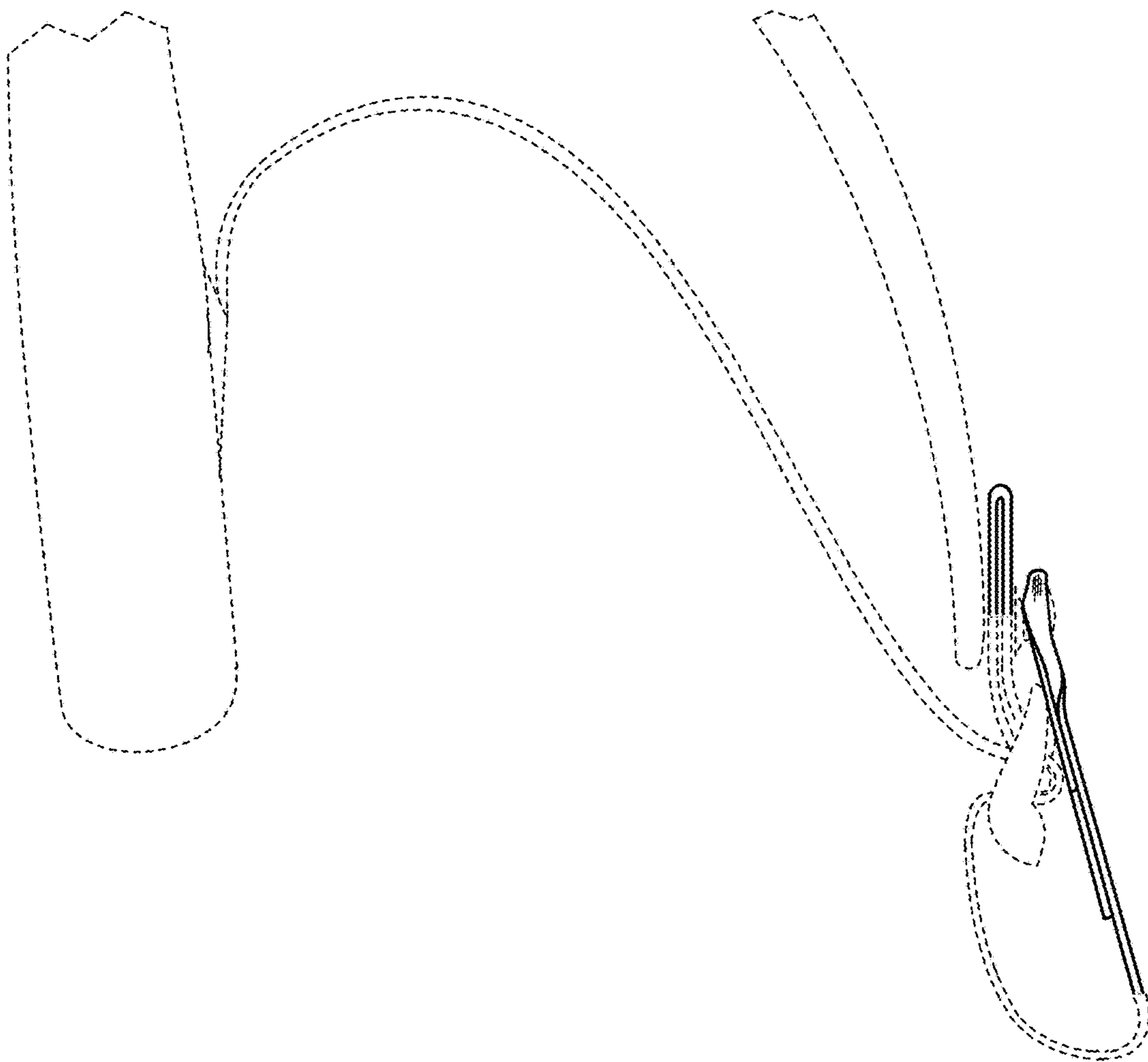

FIG. 10



**FIG. 11**

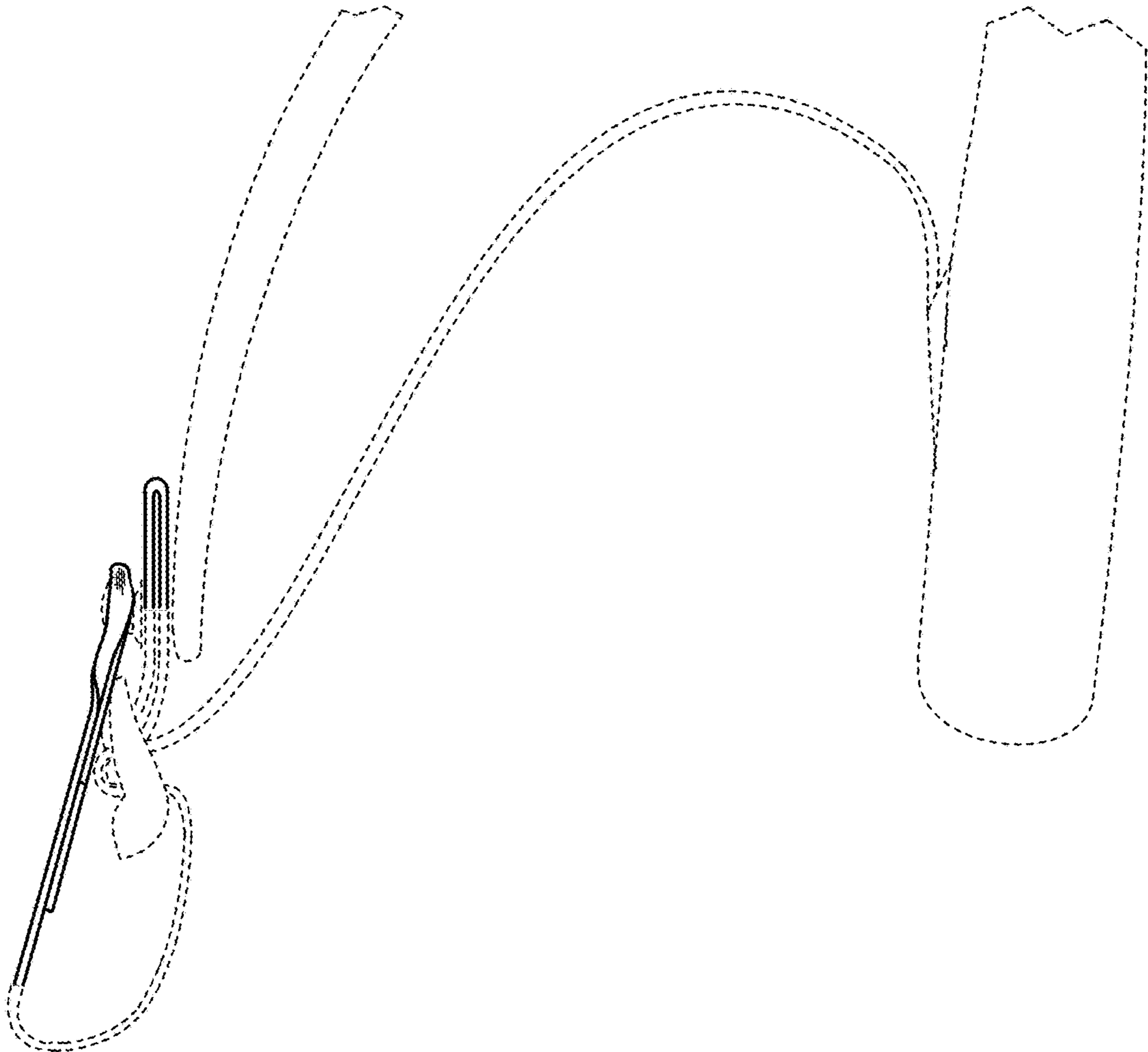

FIG. 12

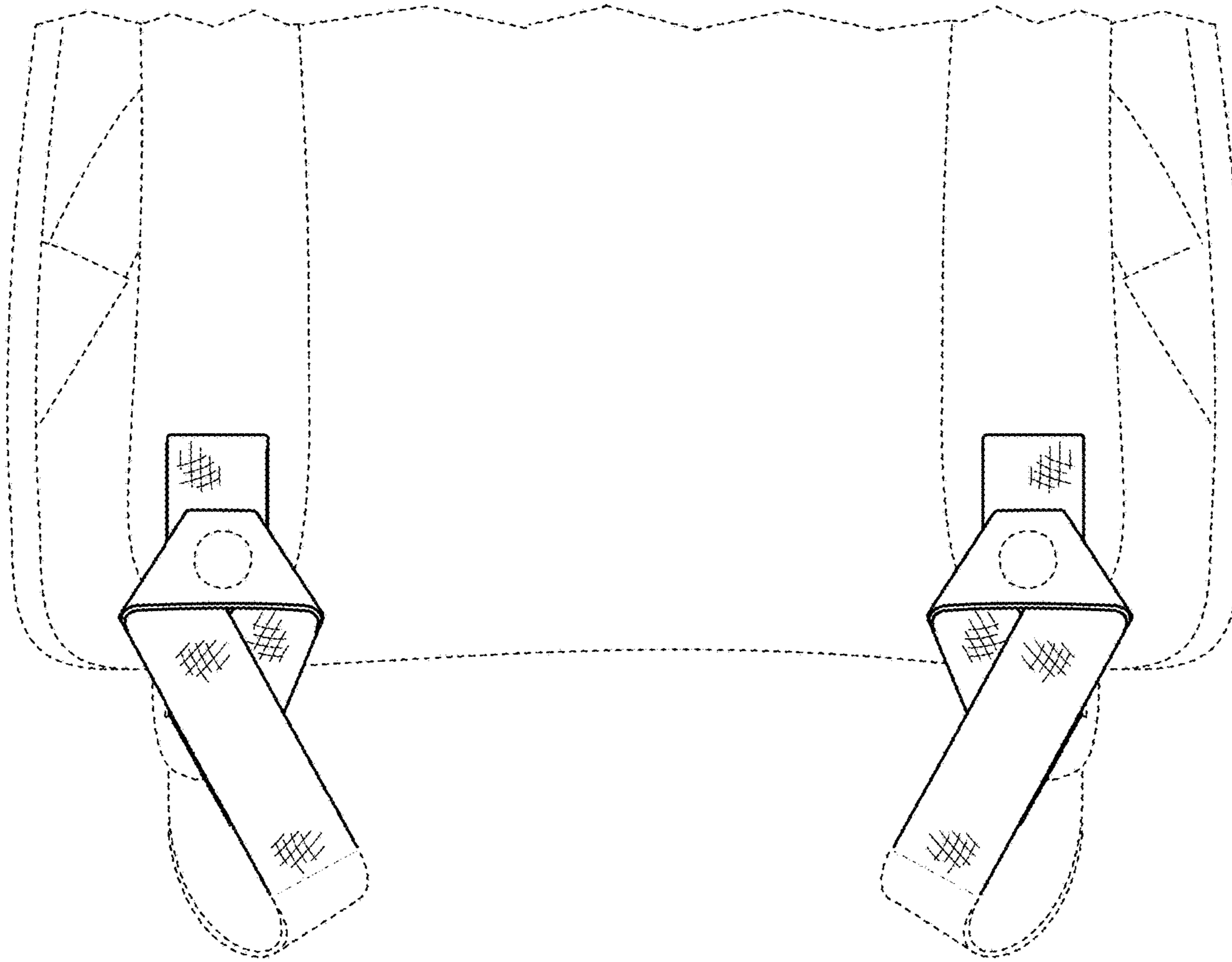

FIG. 13

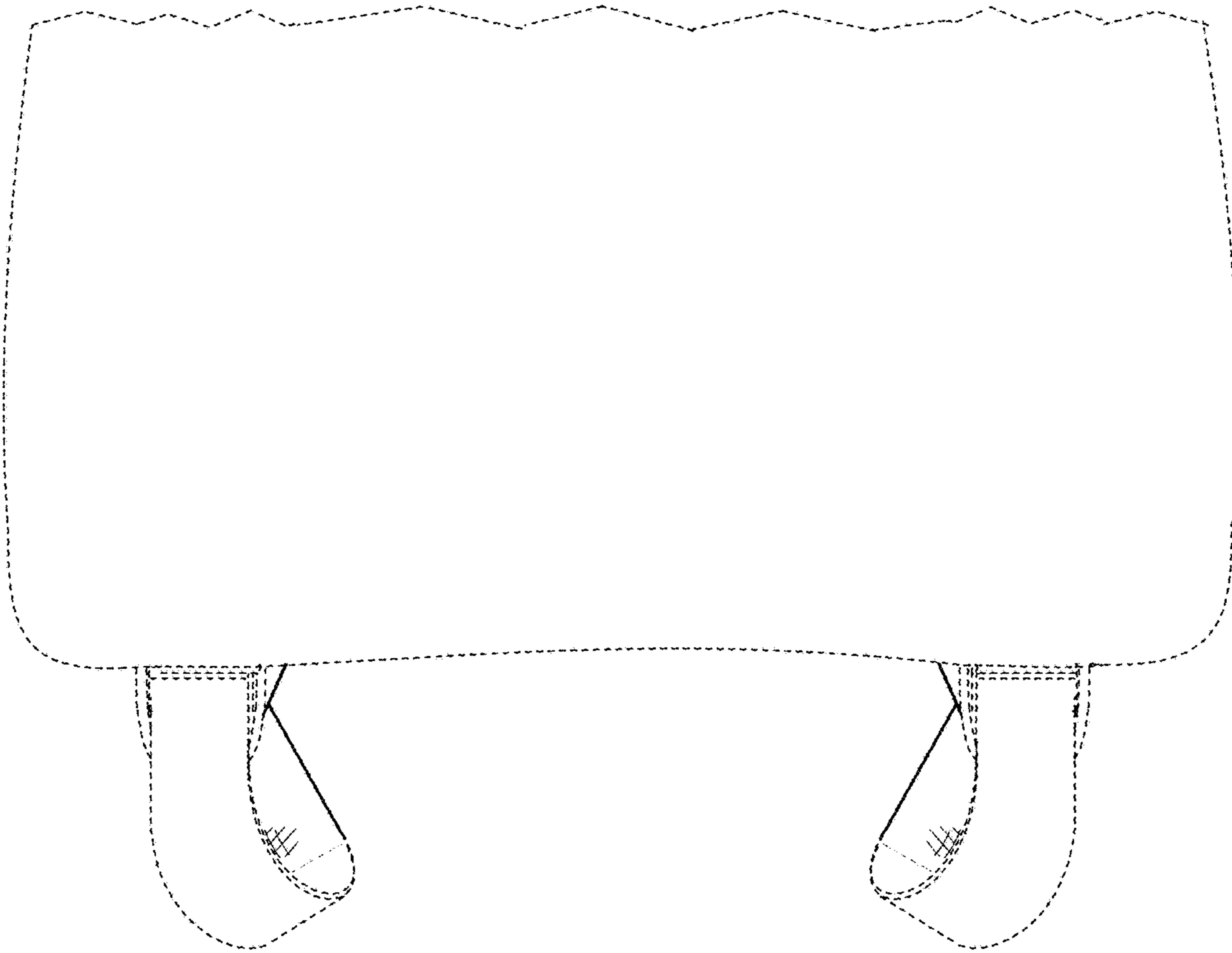

FIG. 14



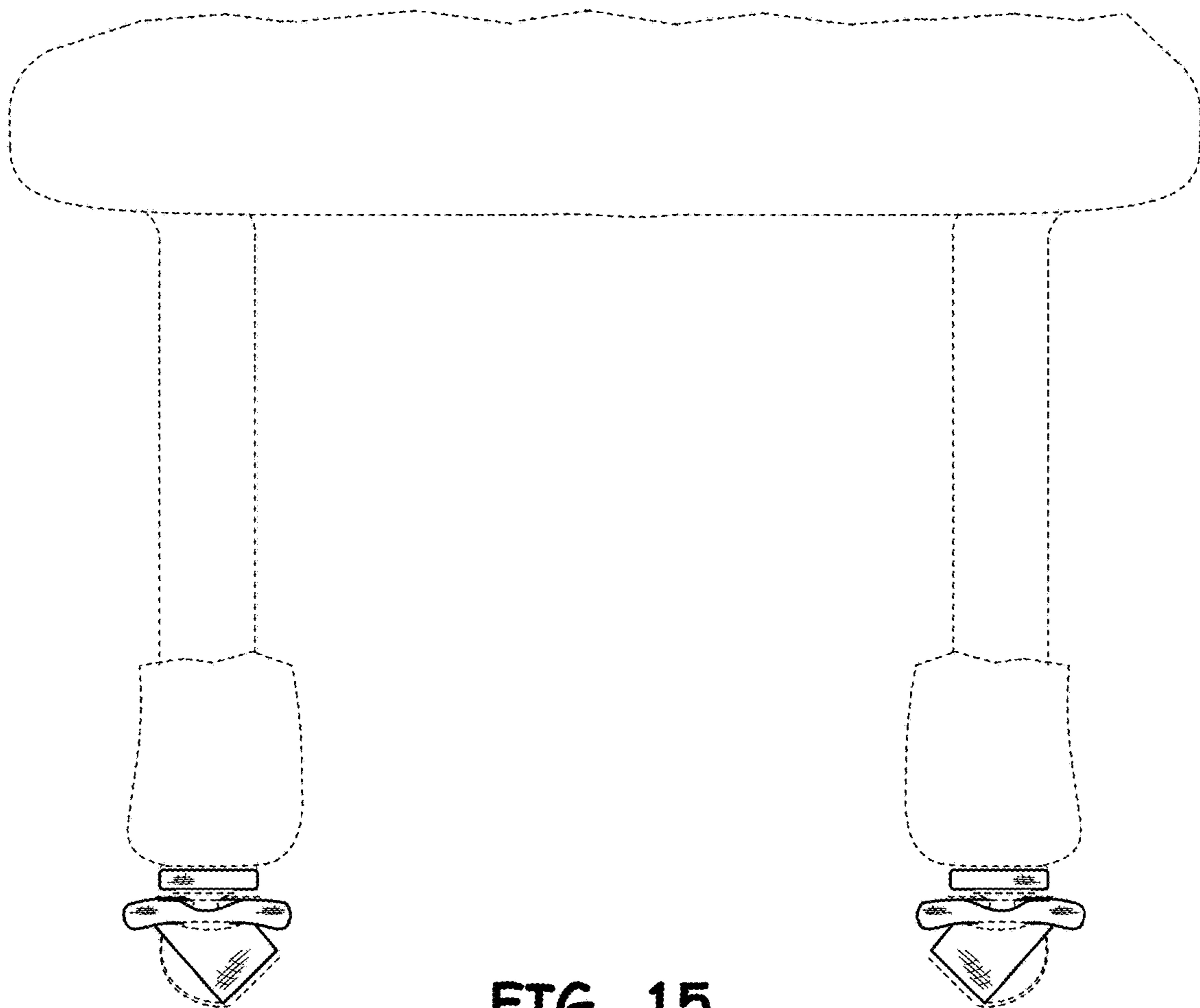

FIG. 15

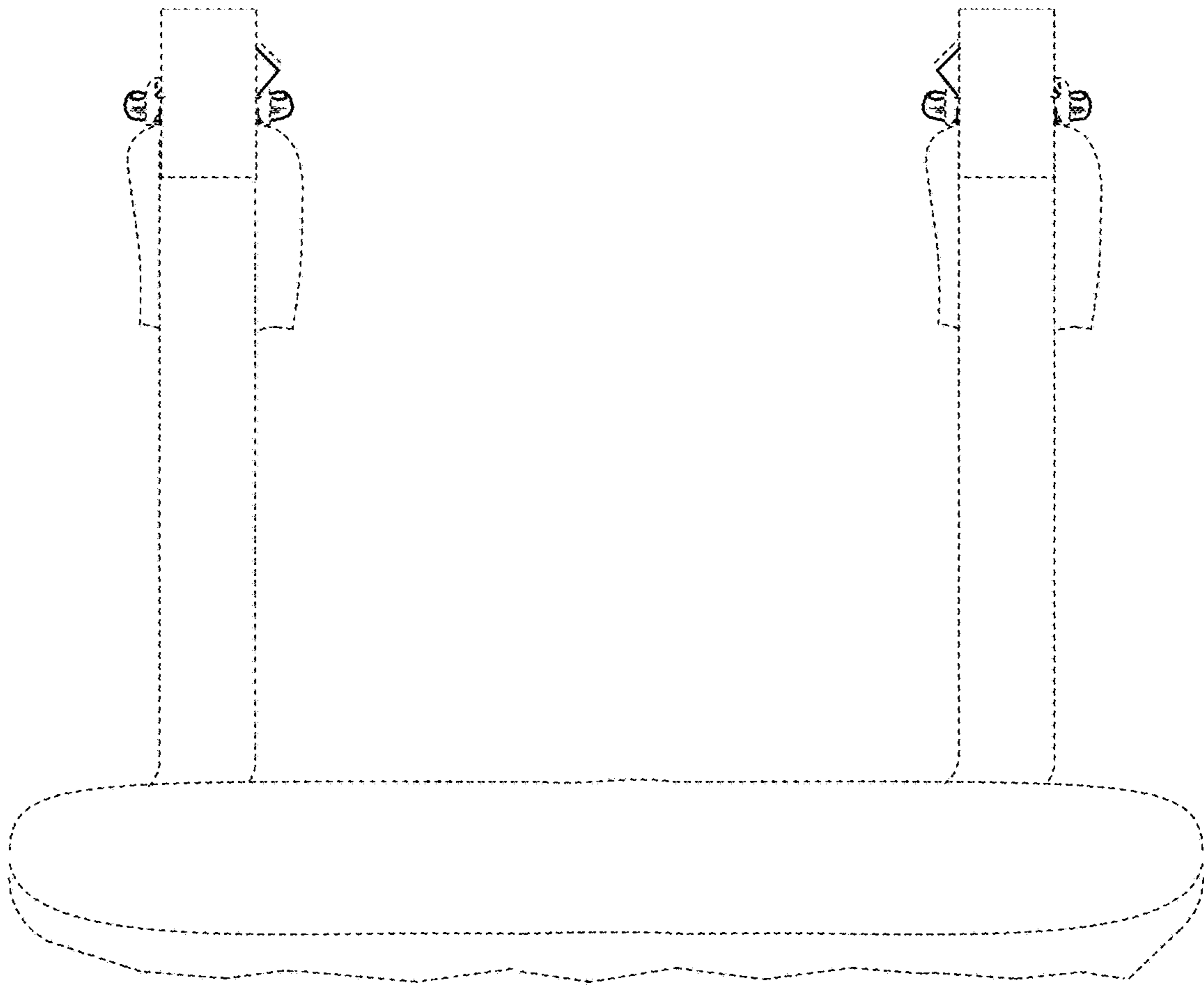

FIG. 16

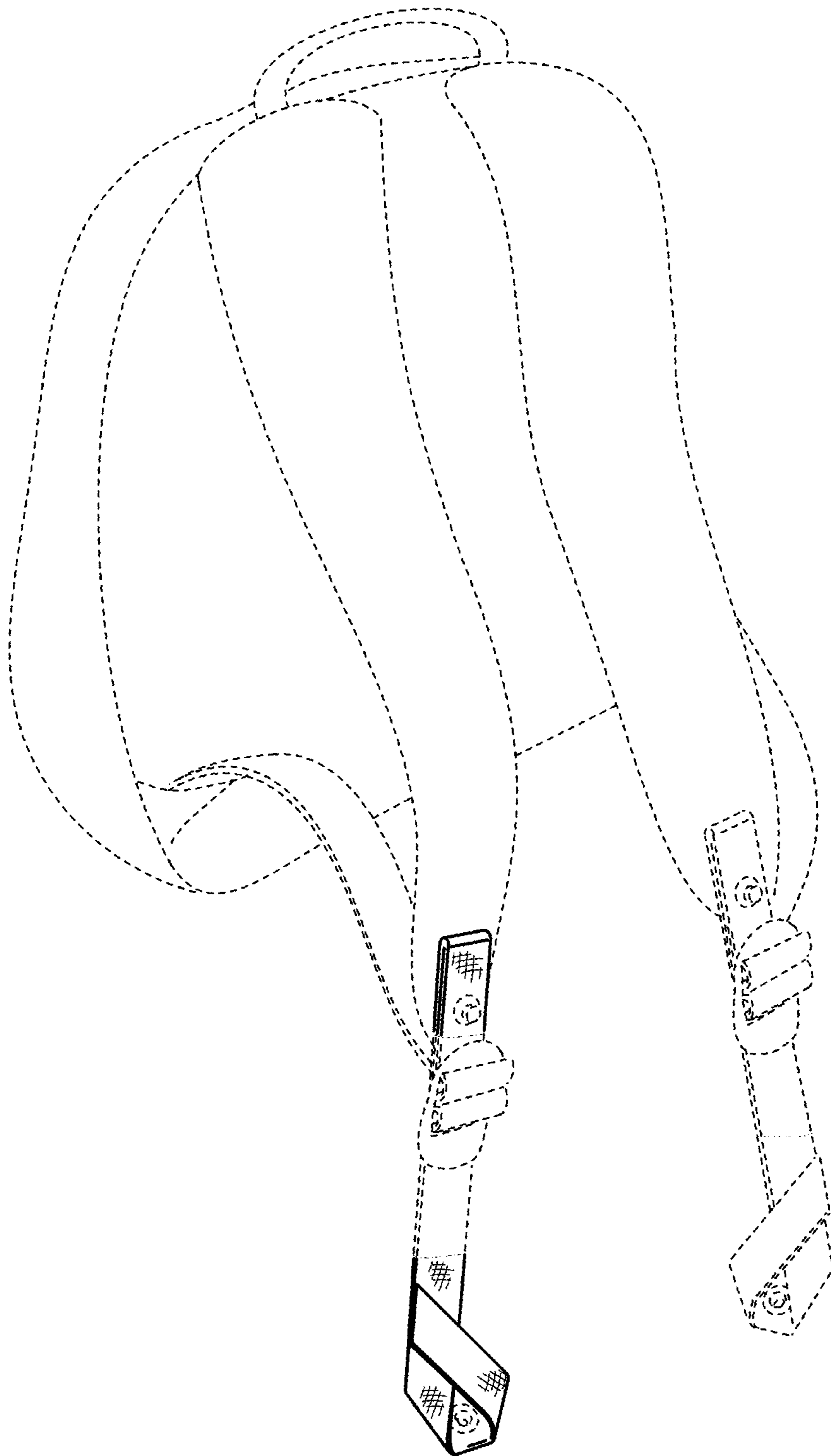

FIG. 17

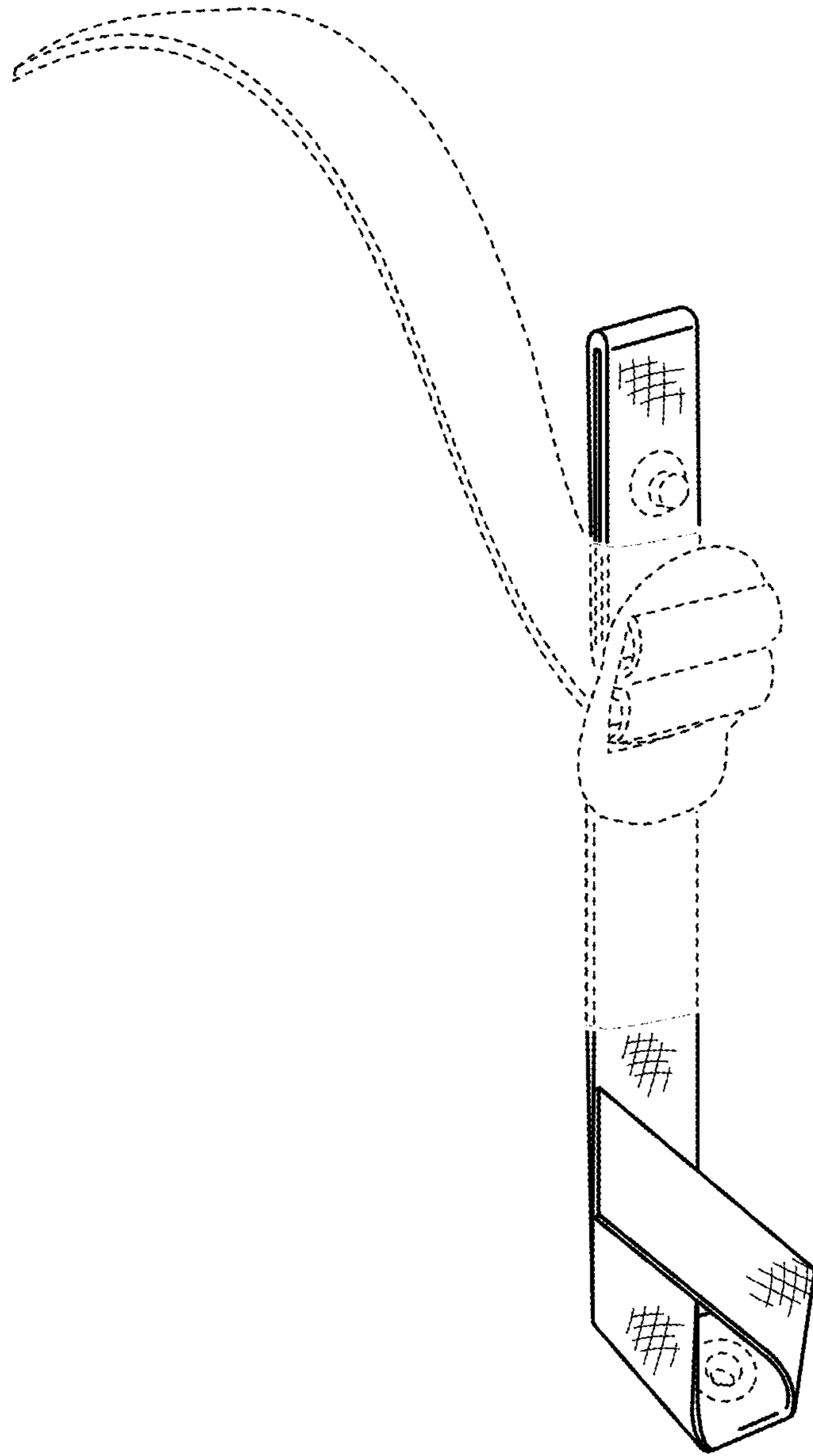

FIG. 18

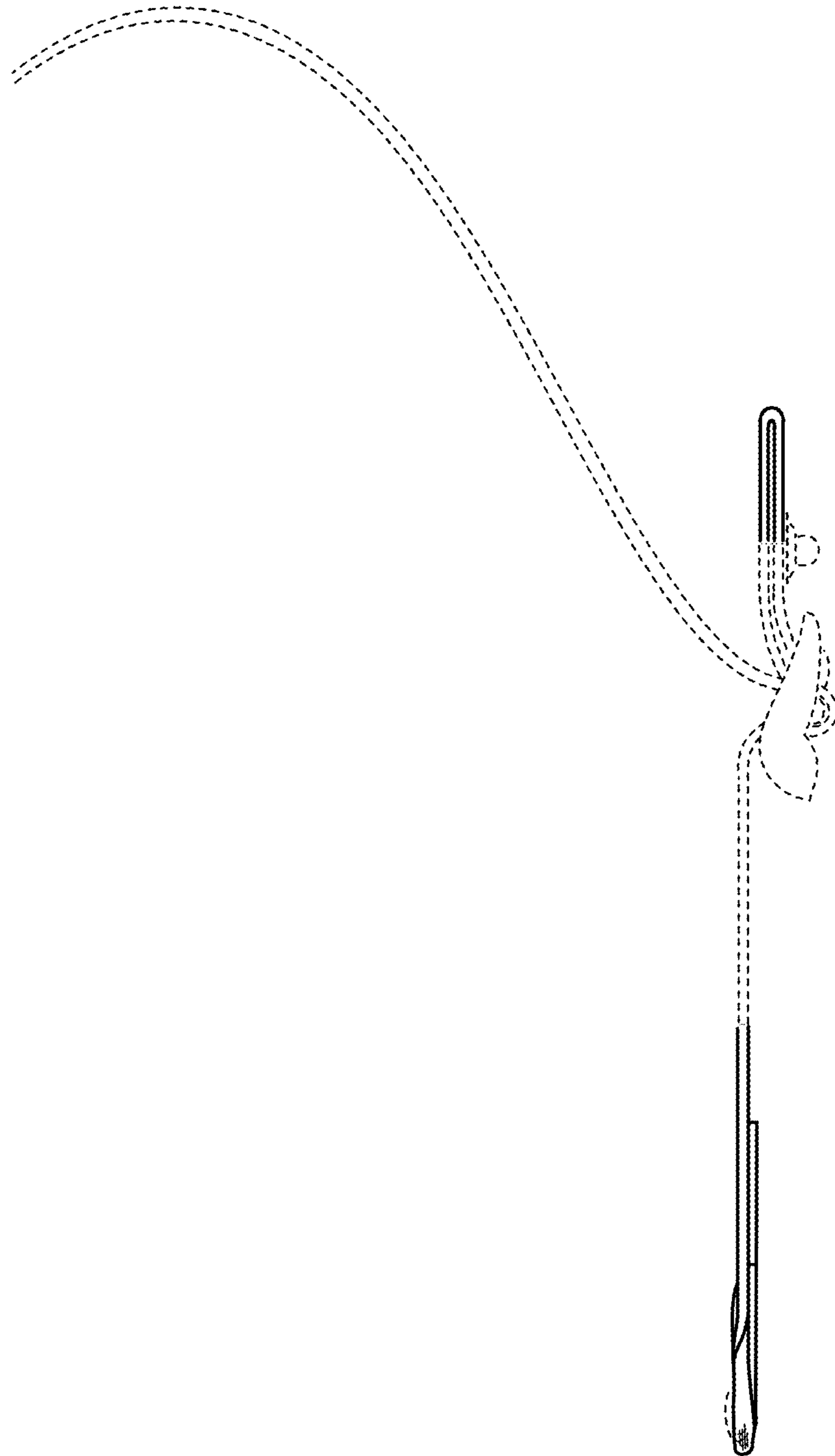

FIG. 19

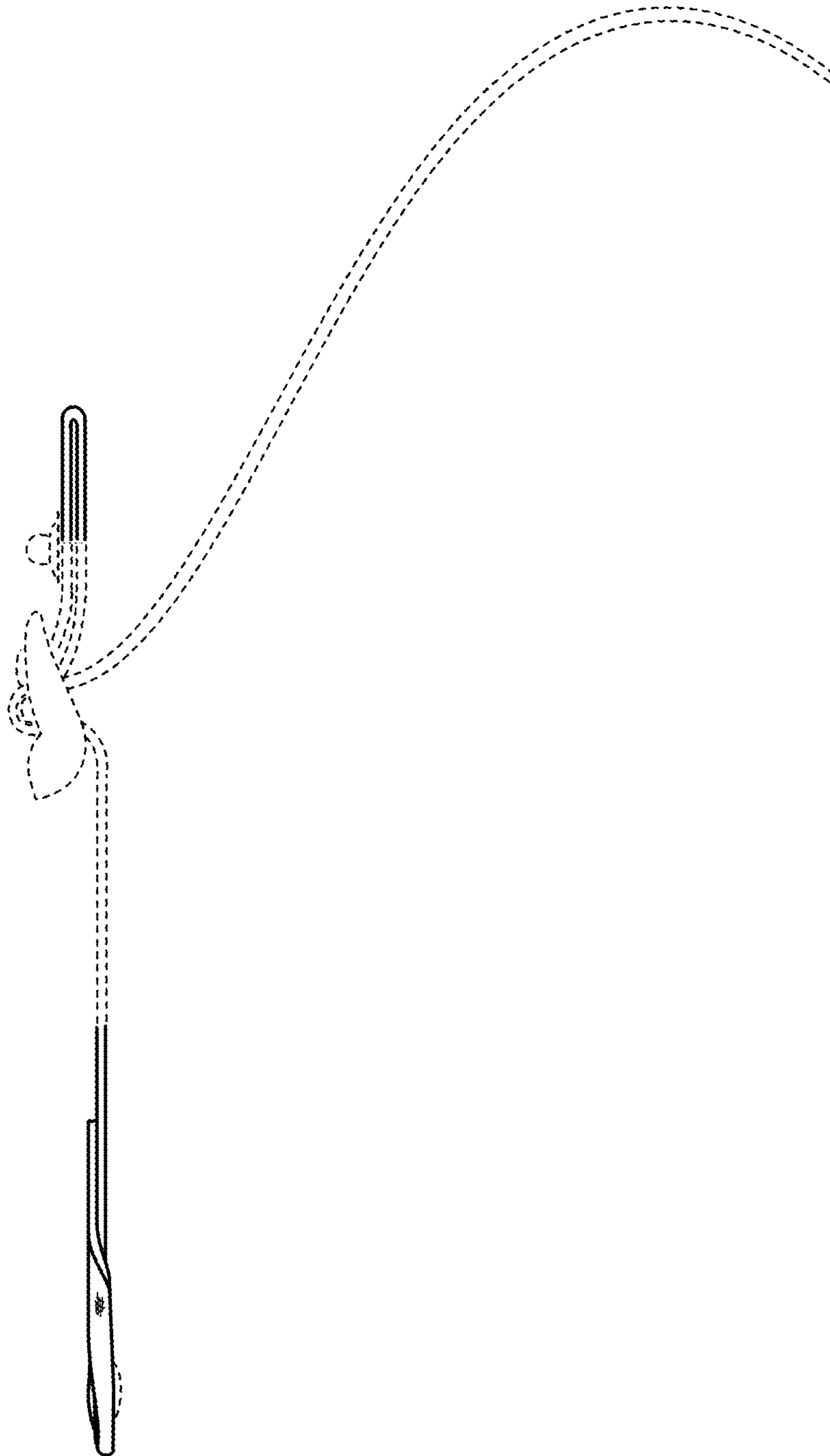

FIG. 20

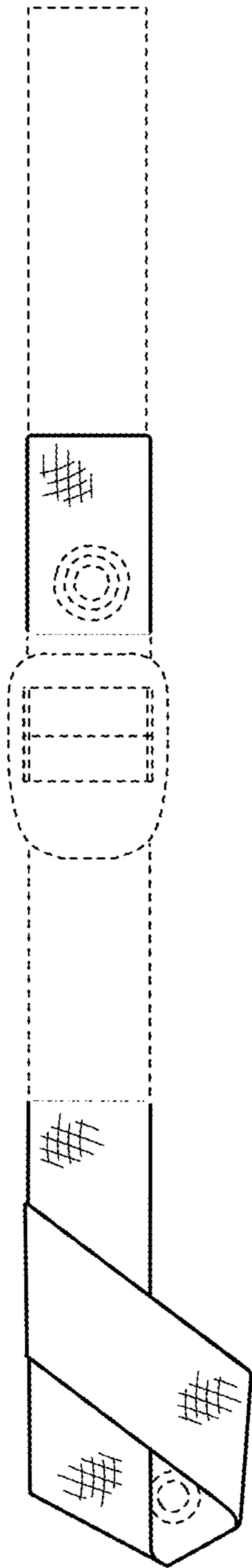

FIG. 21

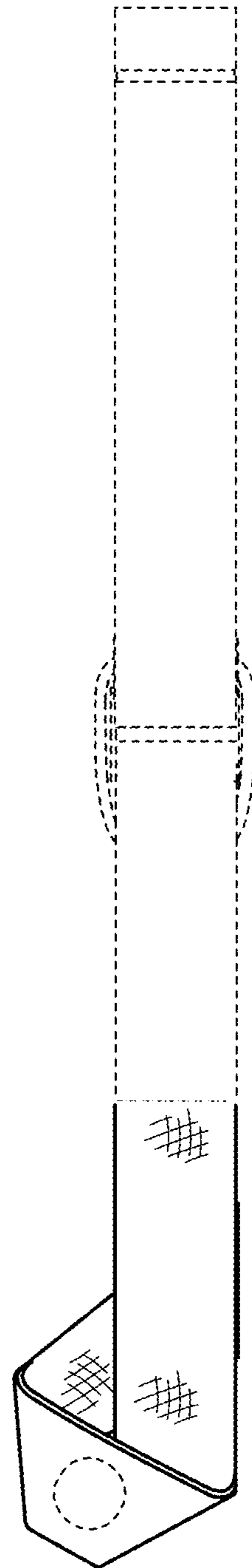

FIG. 22

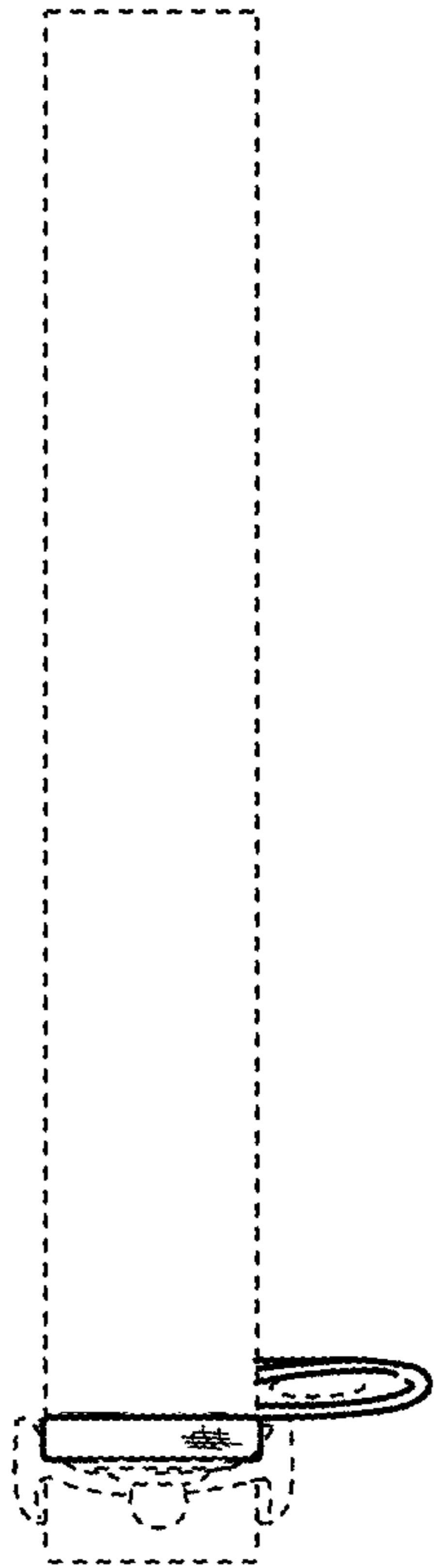

FIG. 23

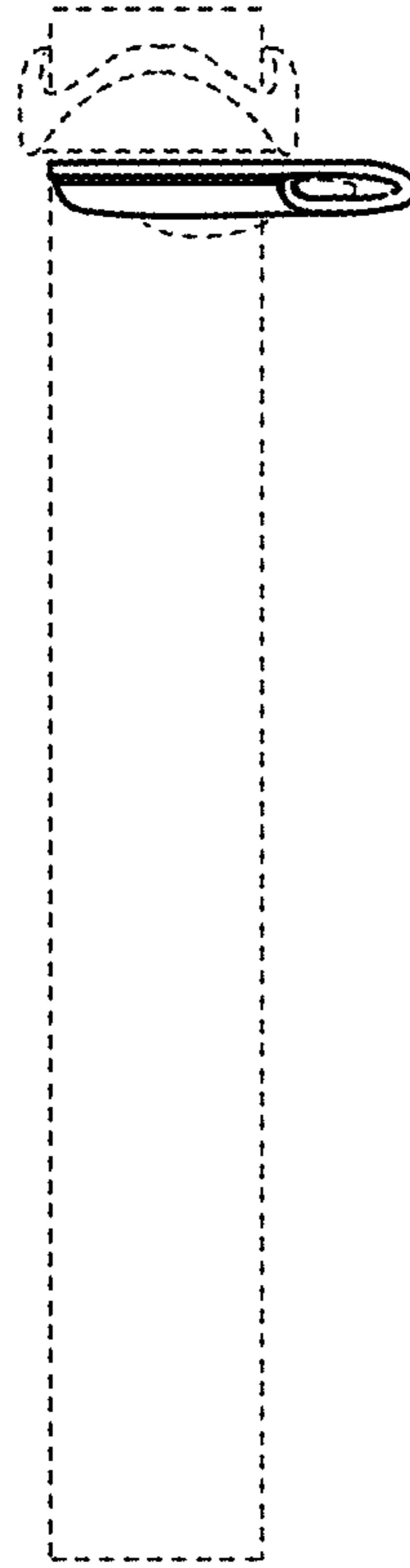

FIG. 24



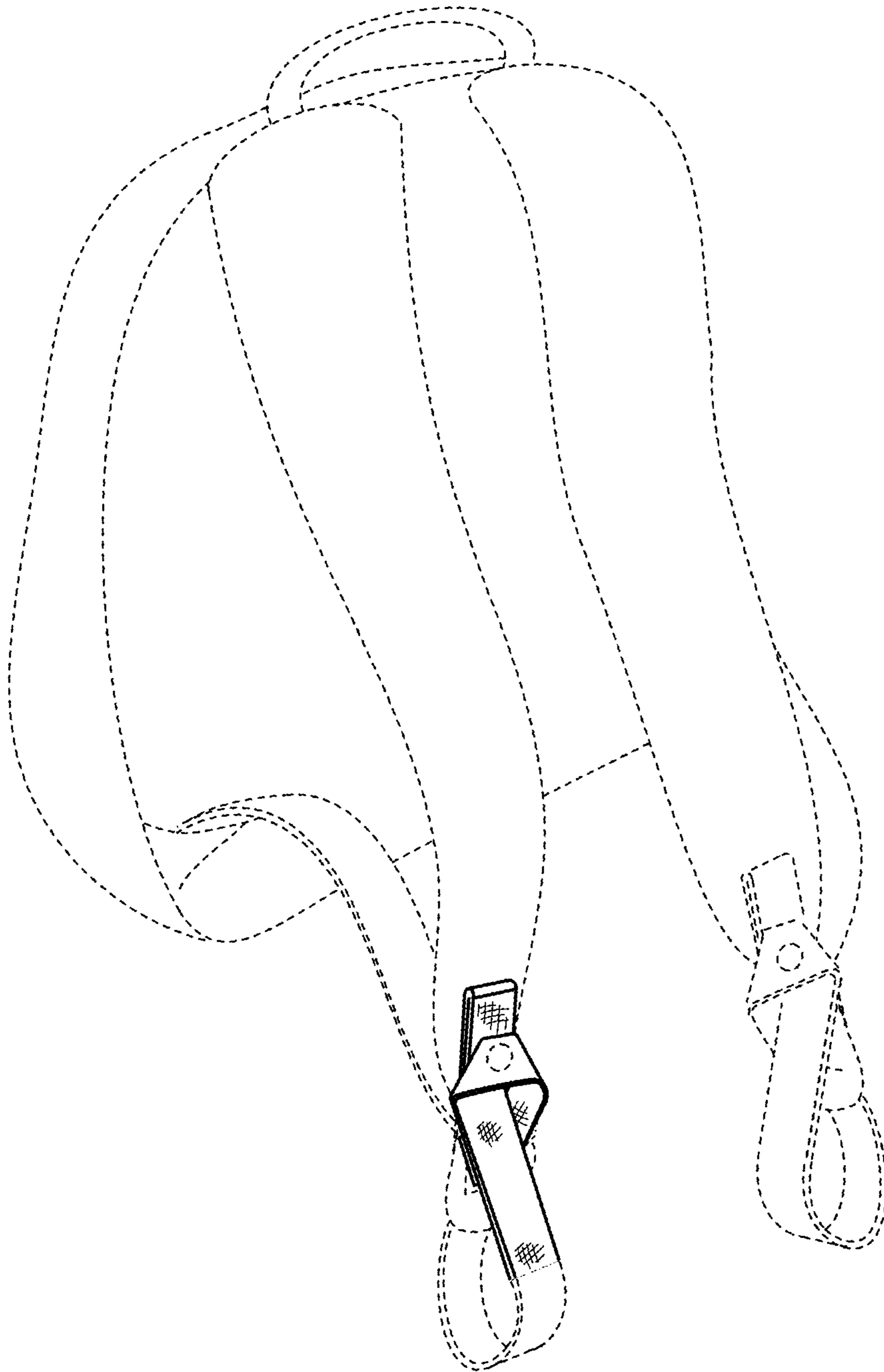

FIG. 25

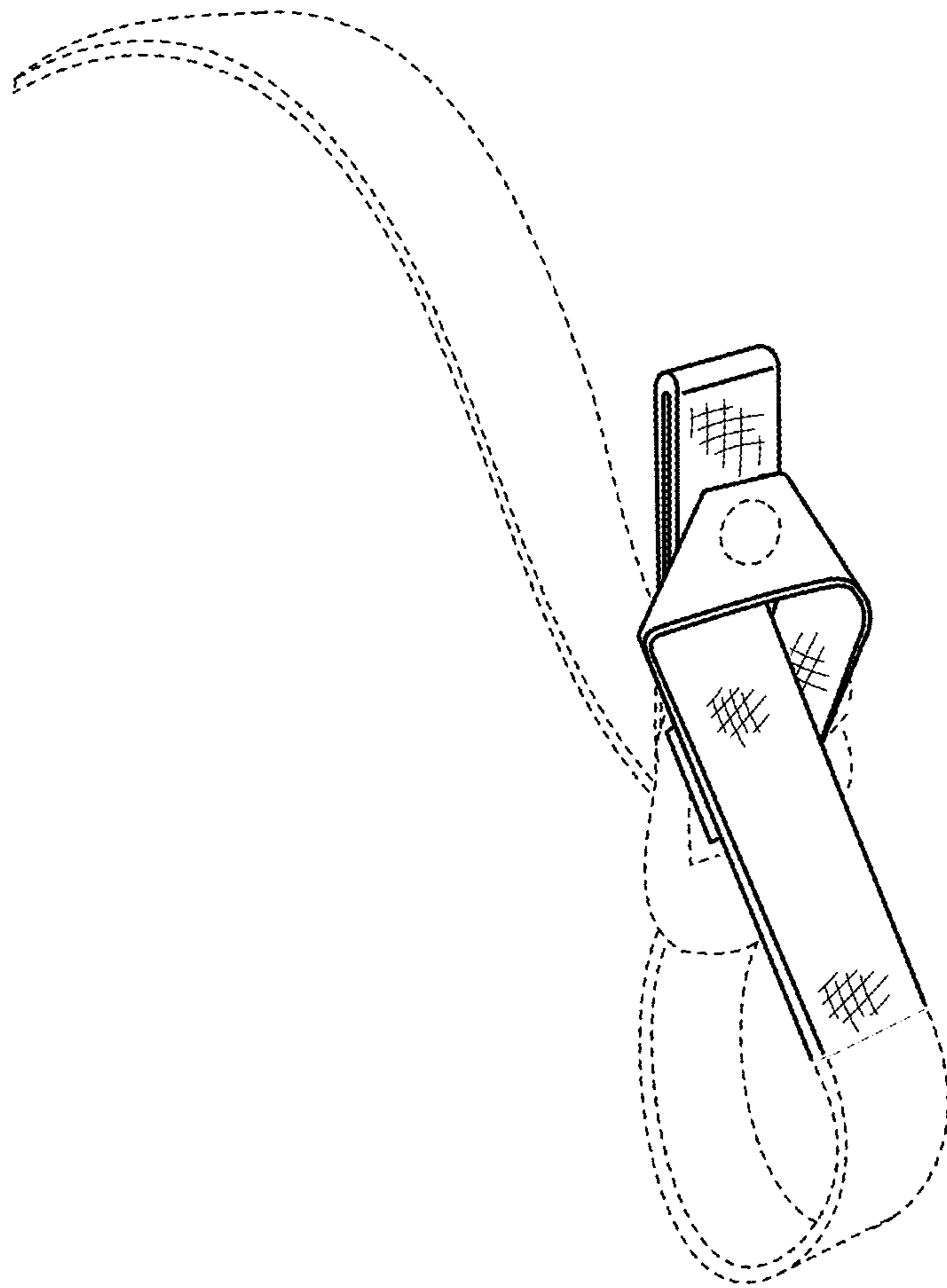
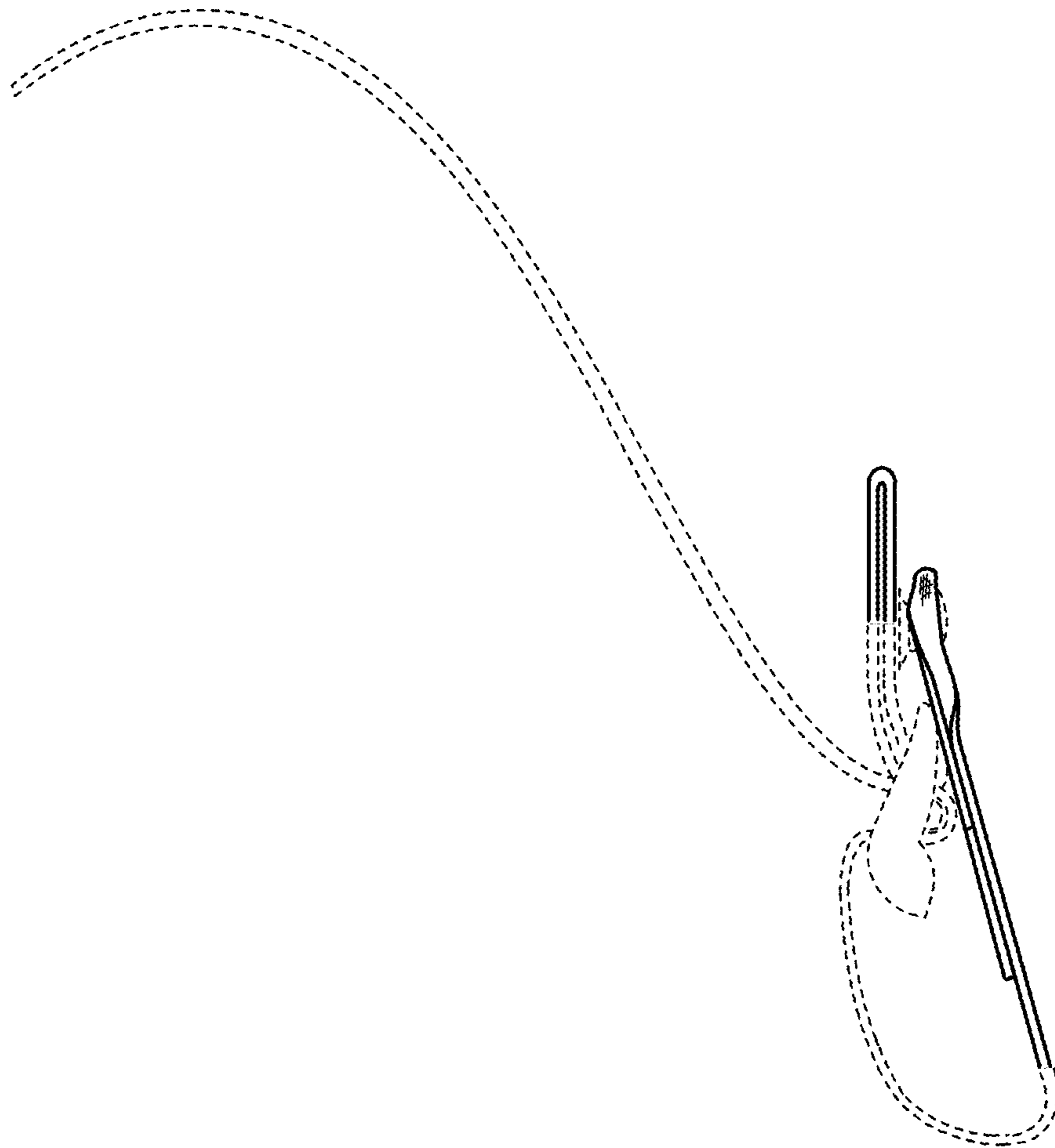

FIG. 26



**FIG. 27**

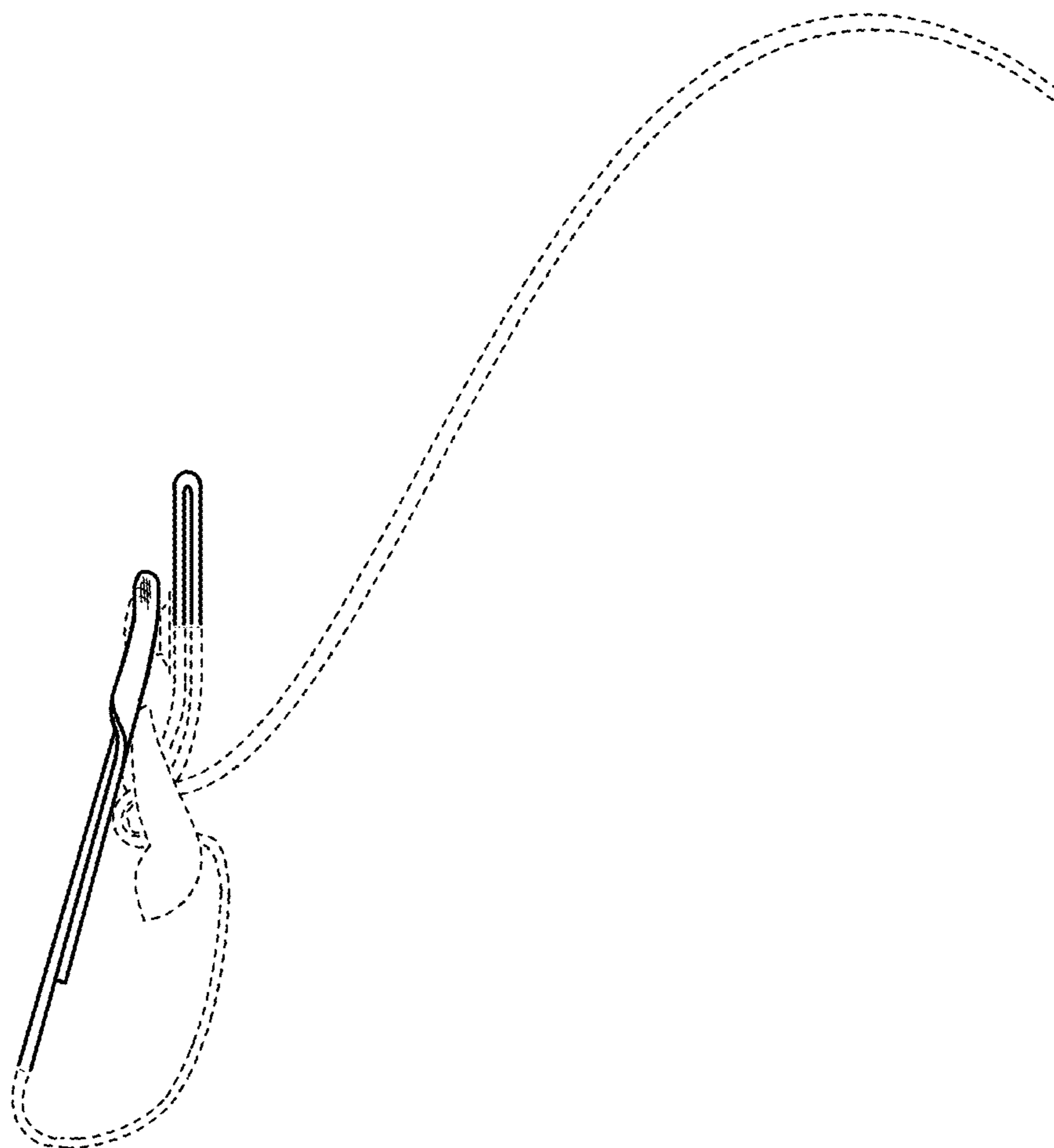
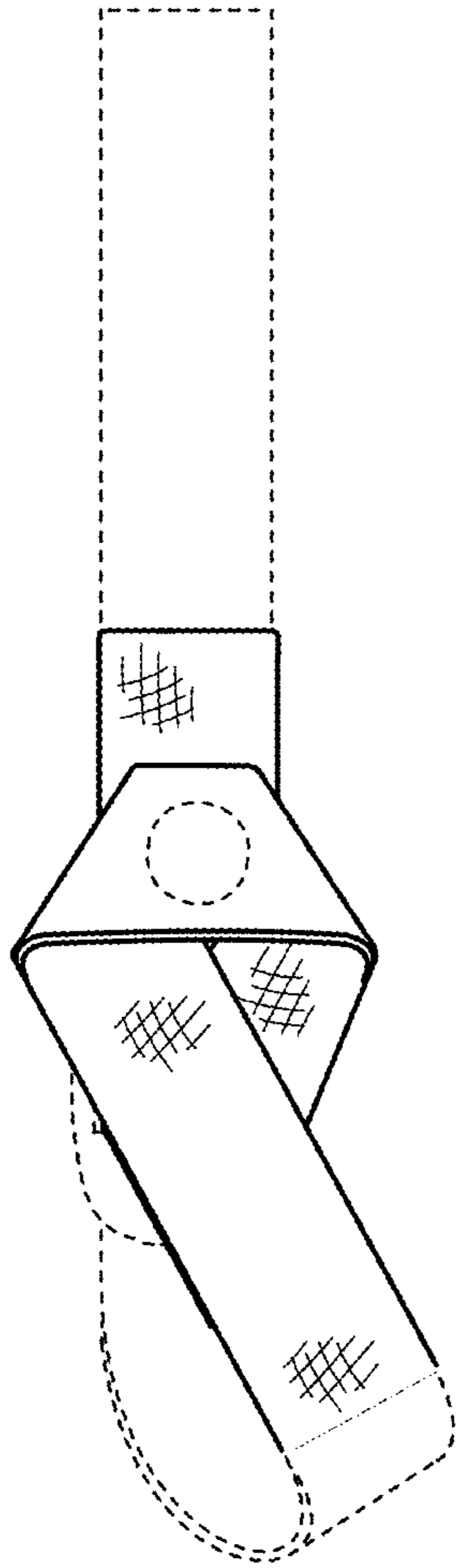
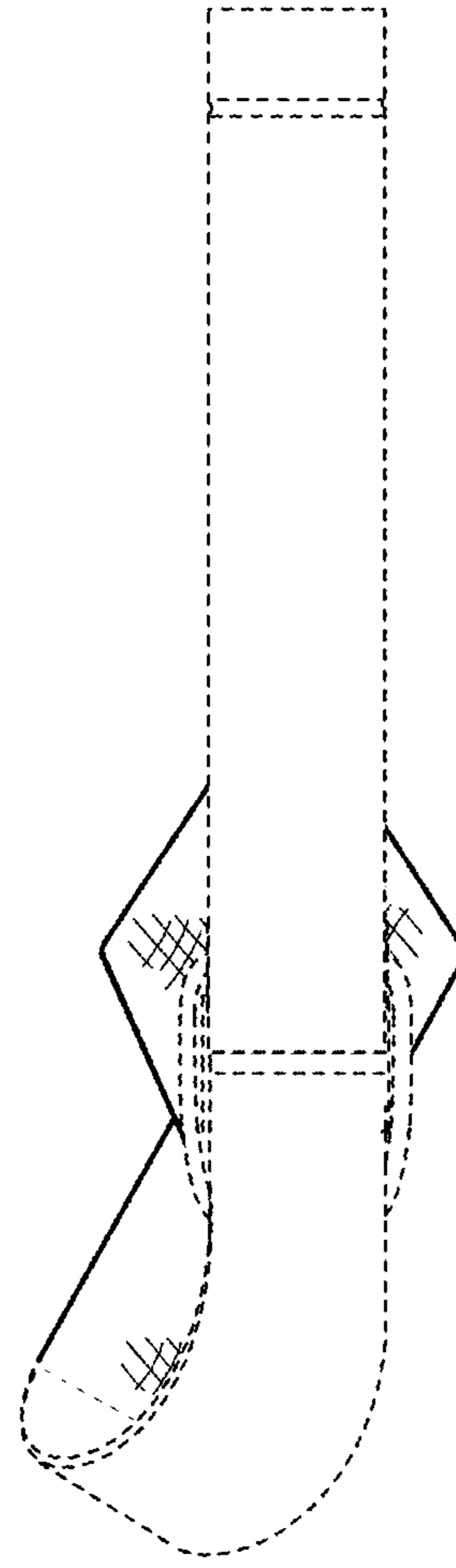

FIG. 28



**FIG. 29**



**FIG. 30**

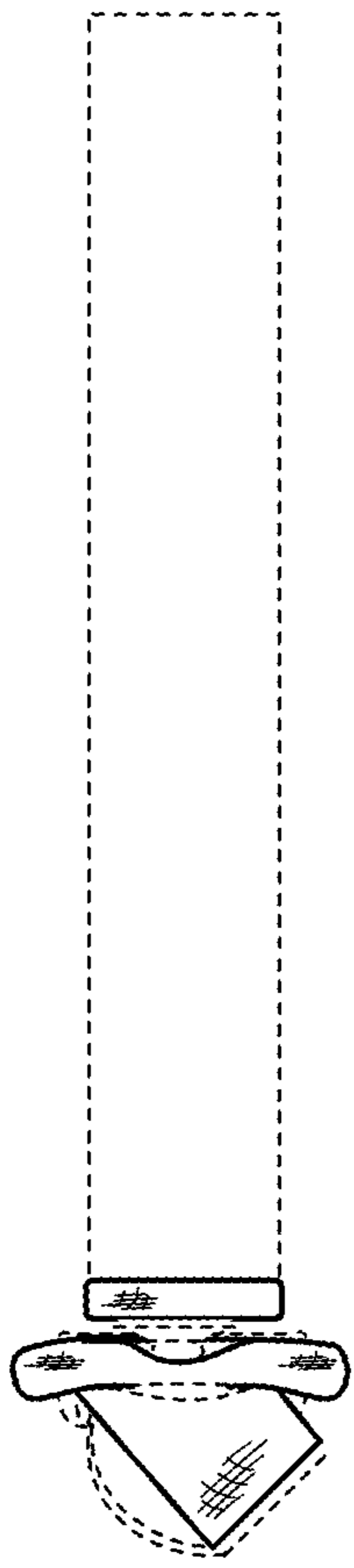

FIG. 31

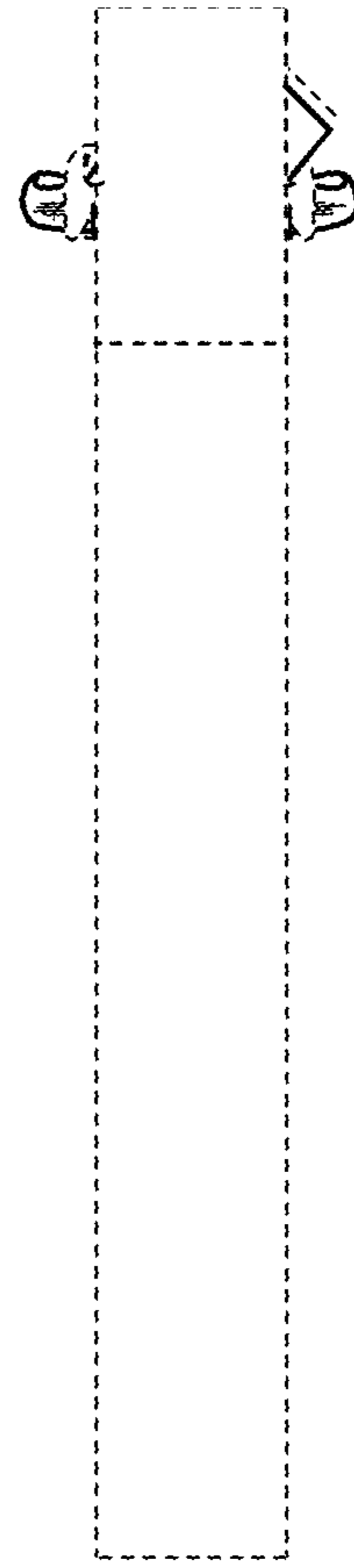

FIG. 32

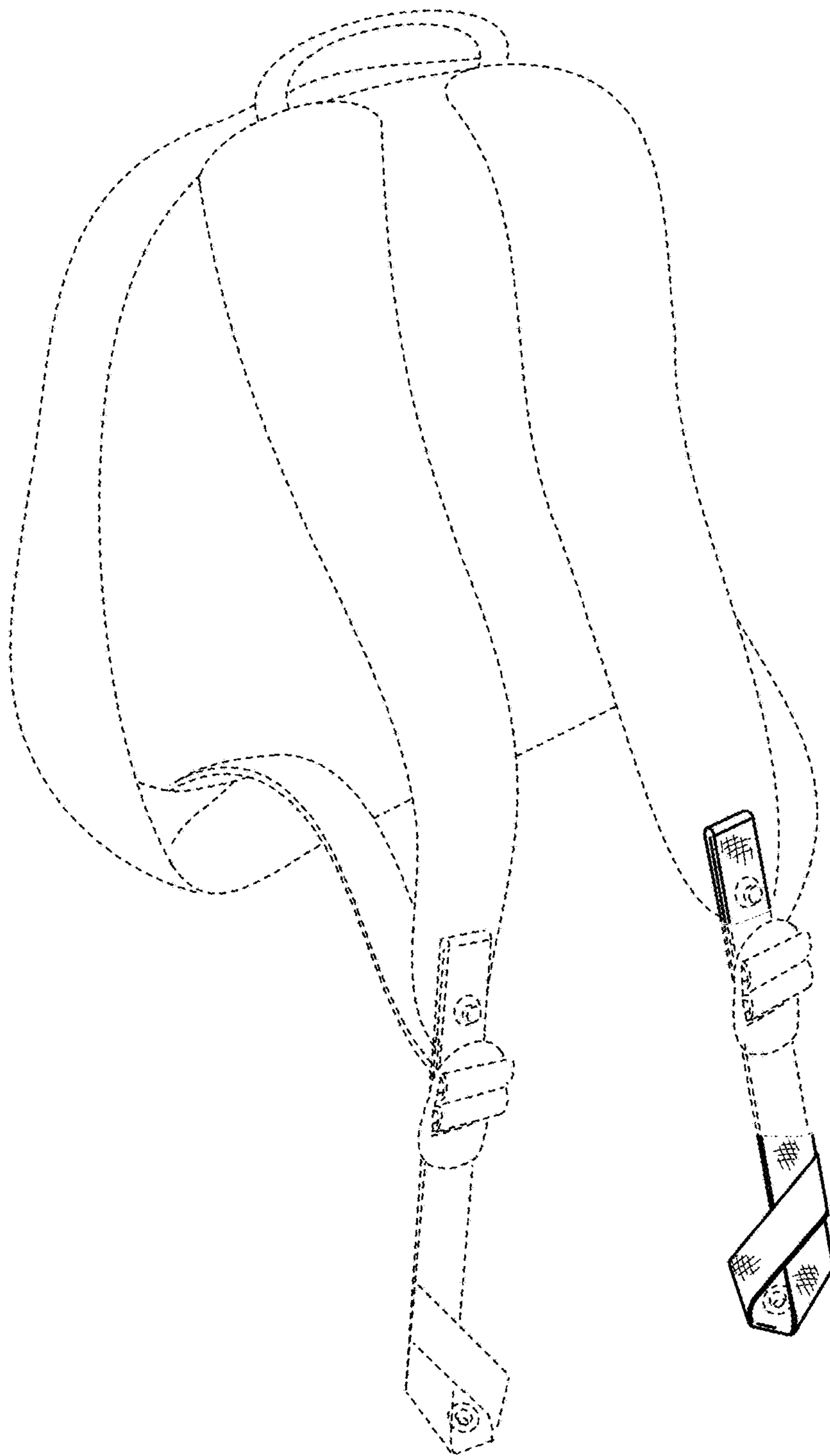

FIG. 33

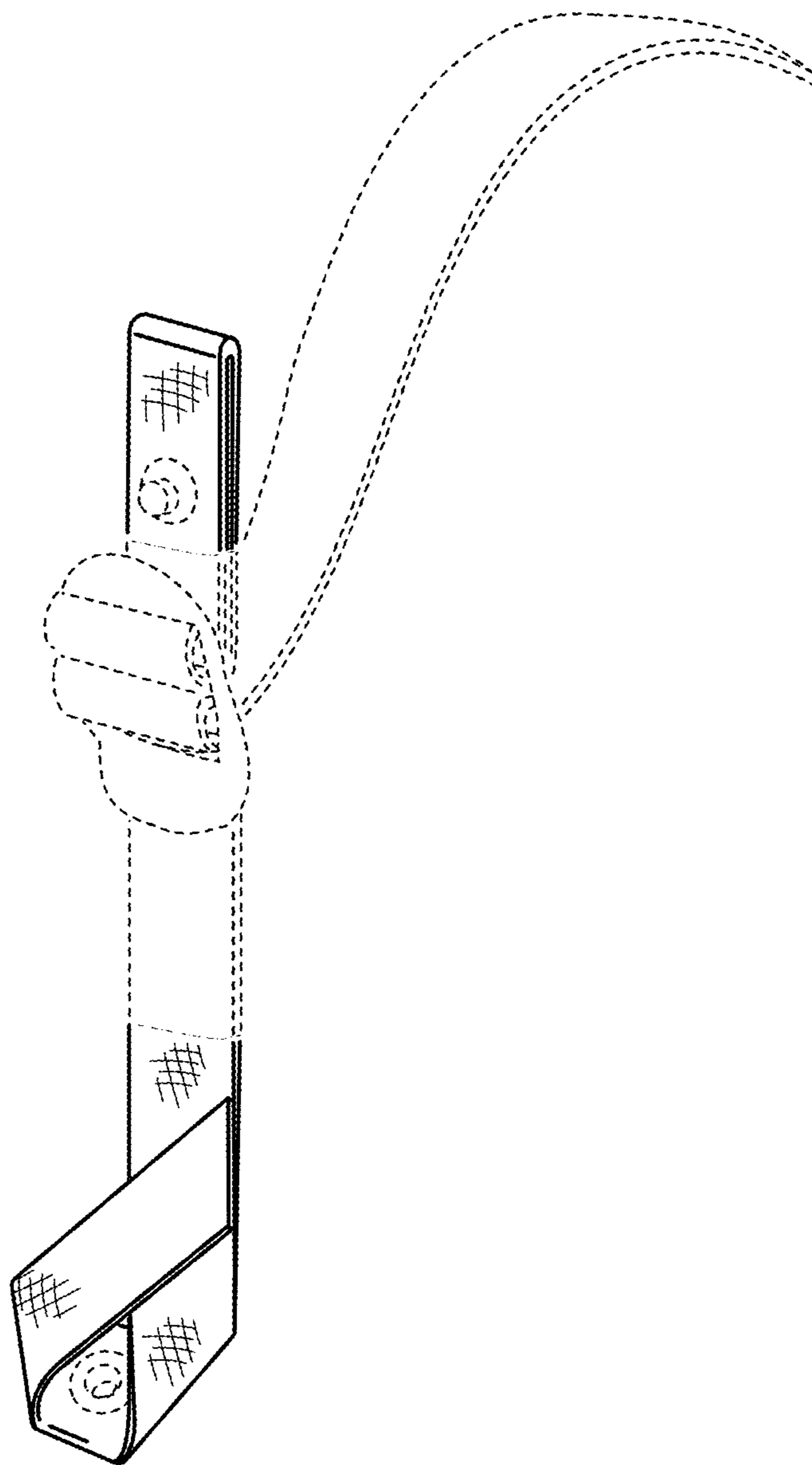

FIG. 34



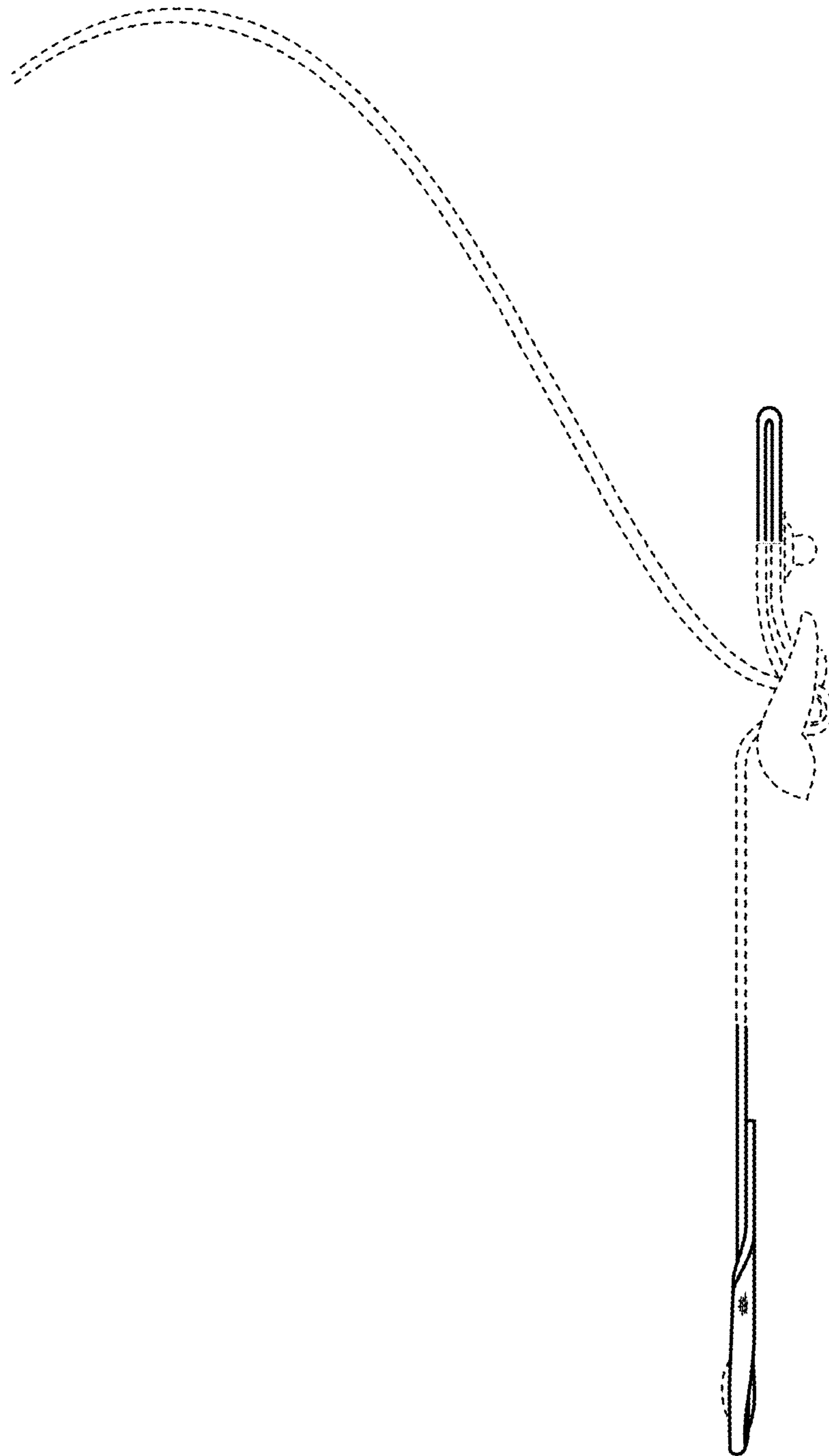

FIG. 35

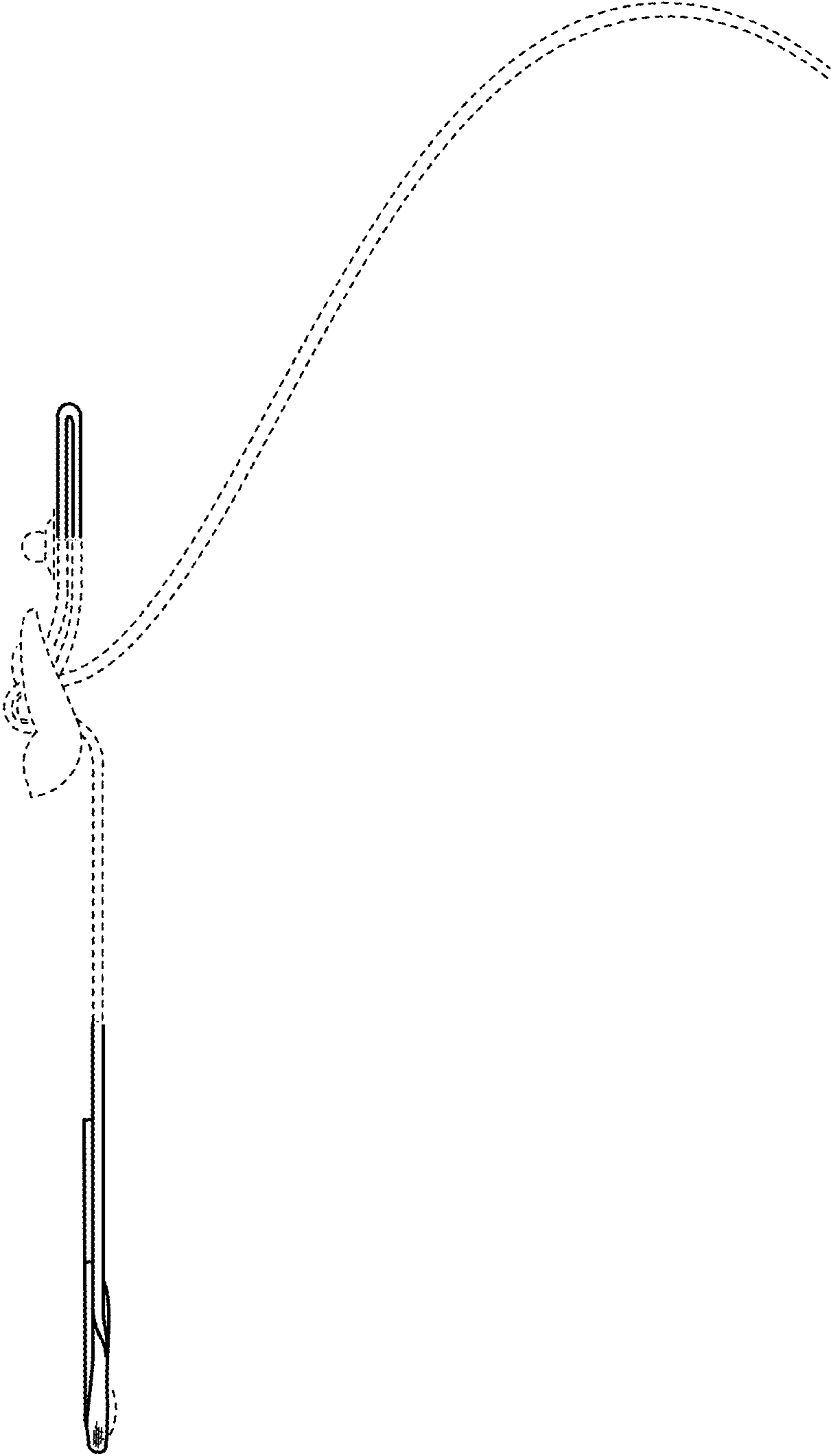

FIG. 36

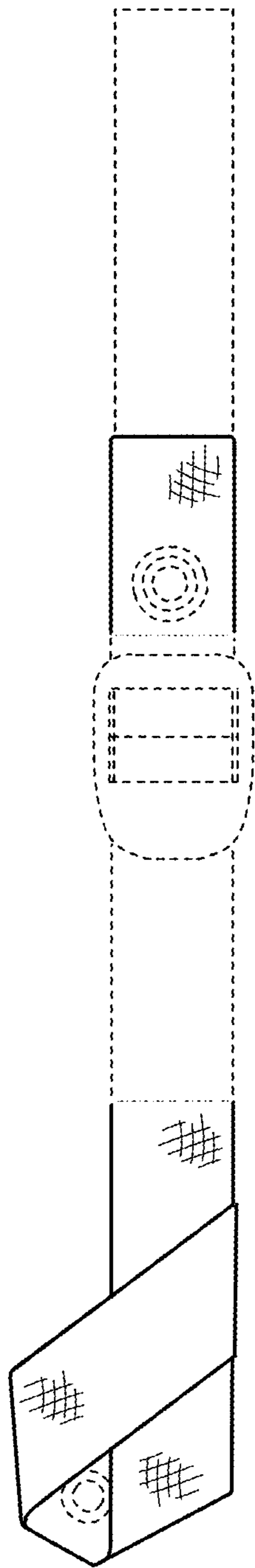

FIG. 37

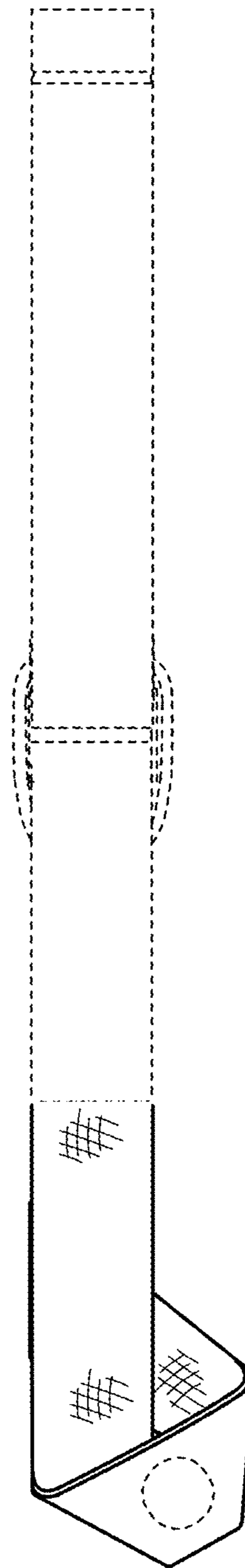

FIG. 38

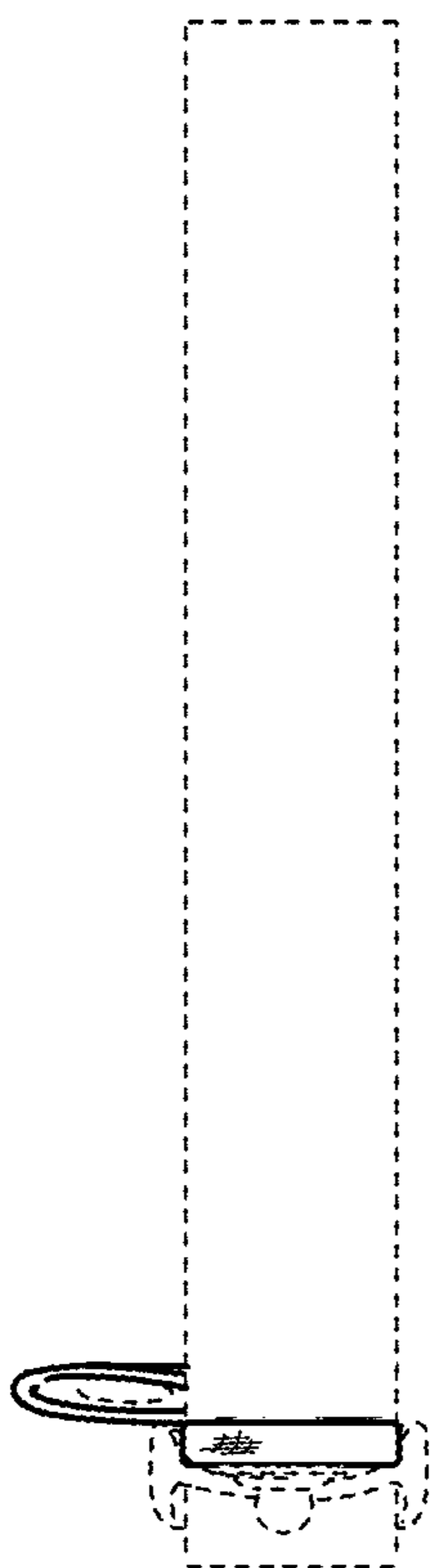

FIG. 39

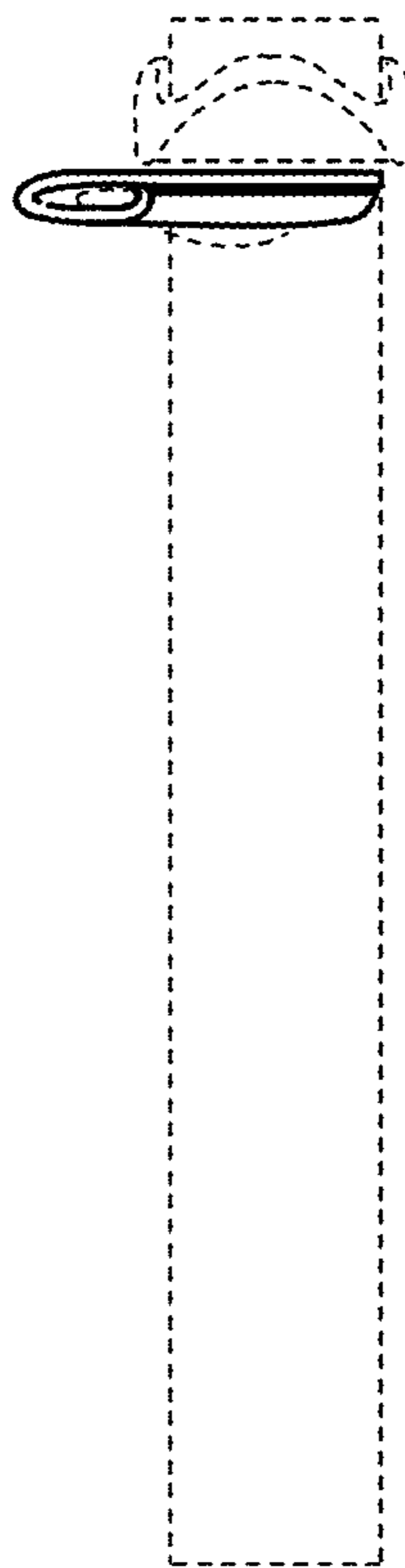
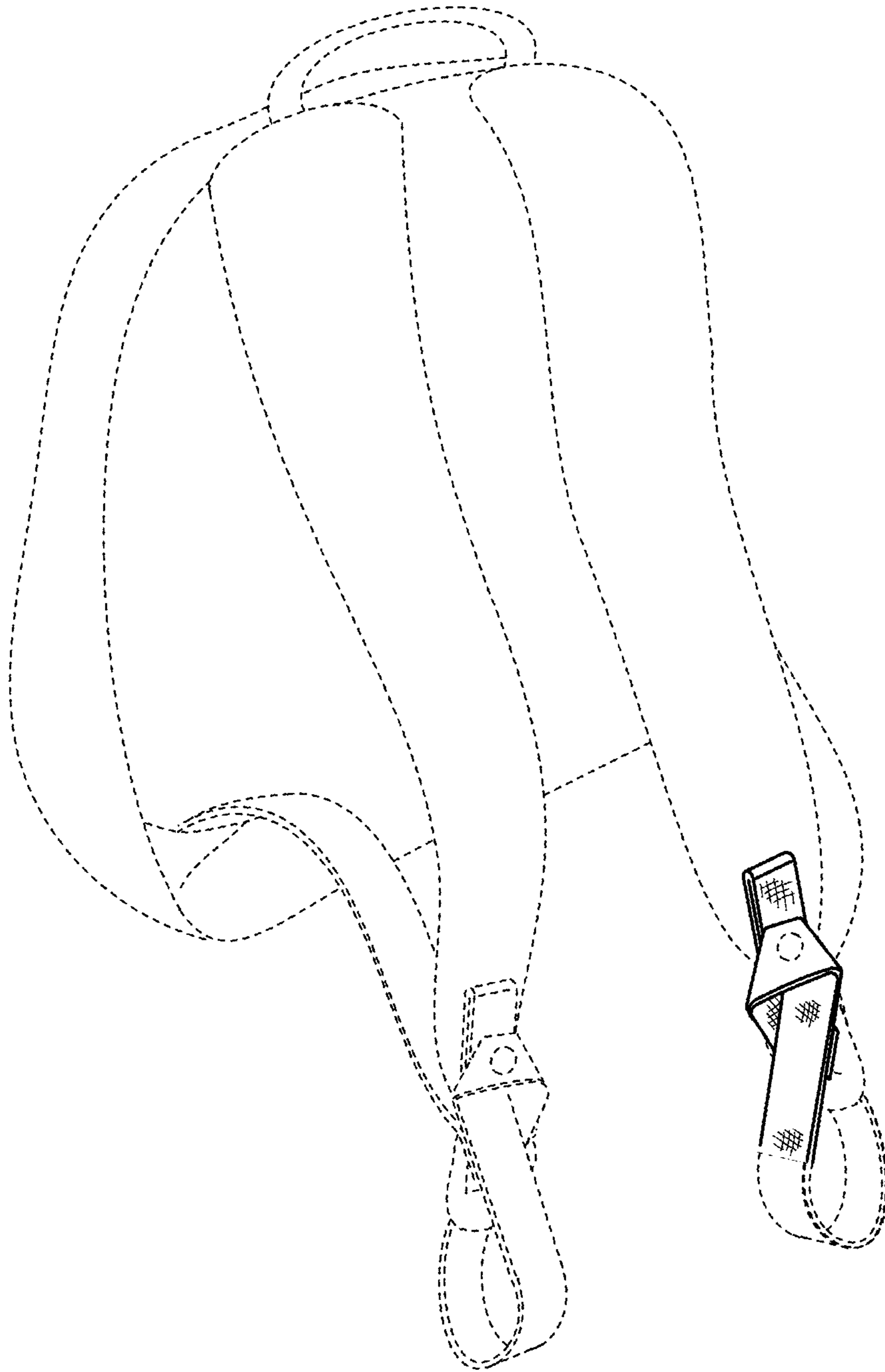
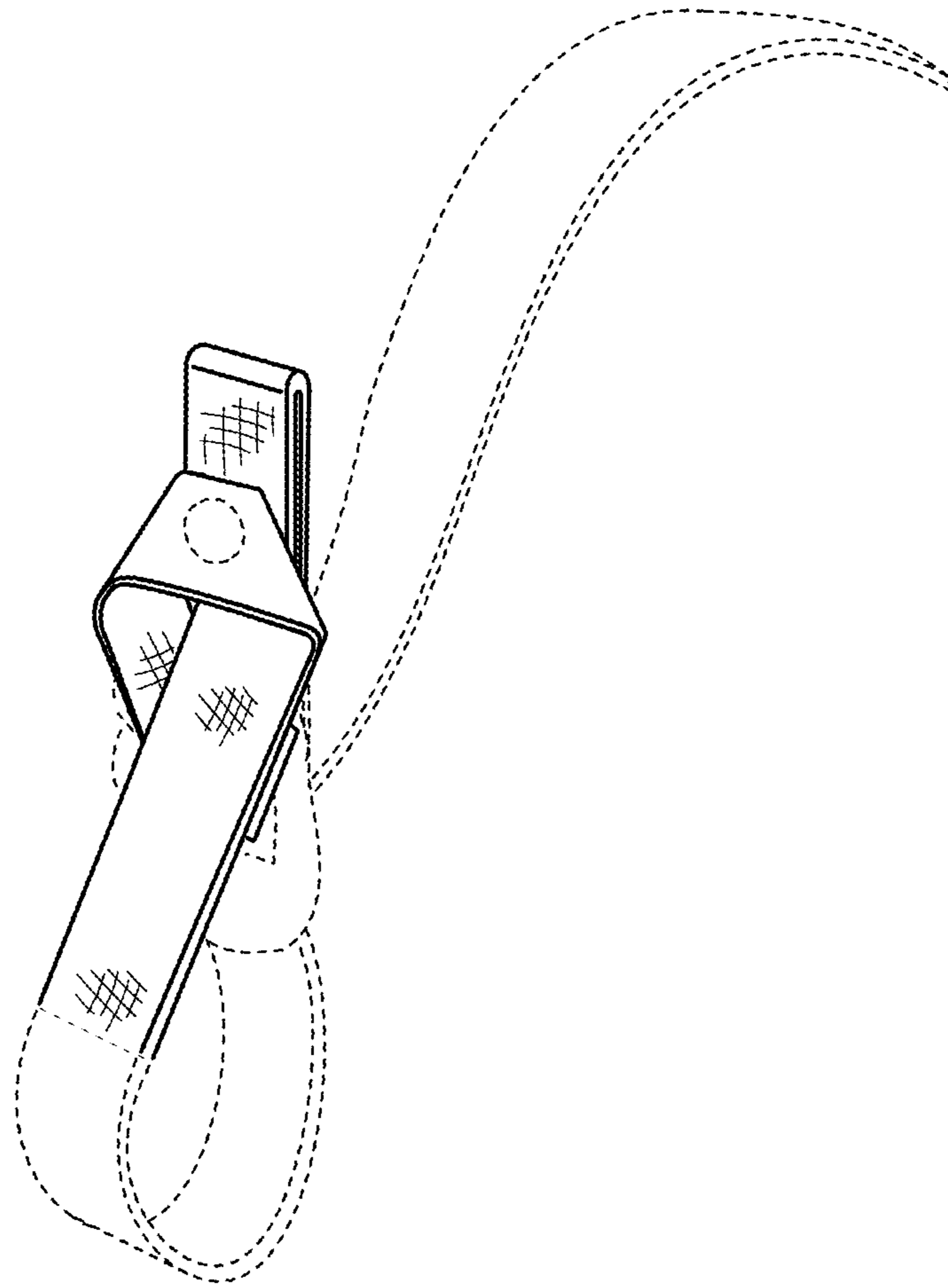

FIG. 40



**FIG. 41**



**FIG. 42**

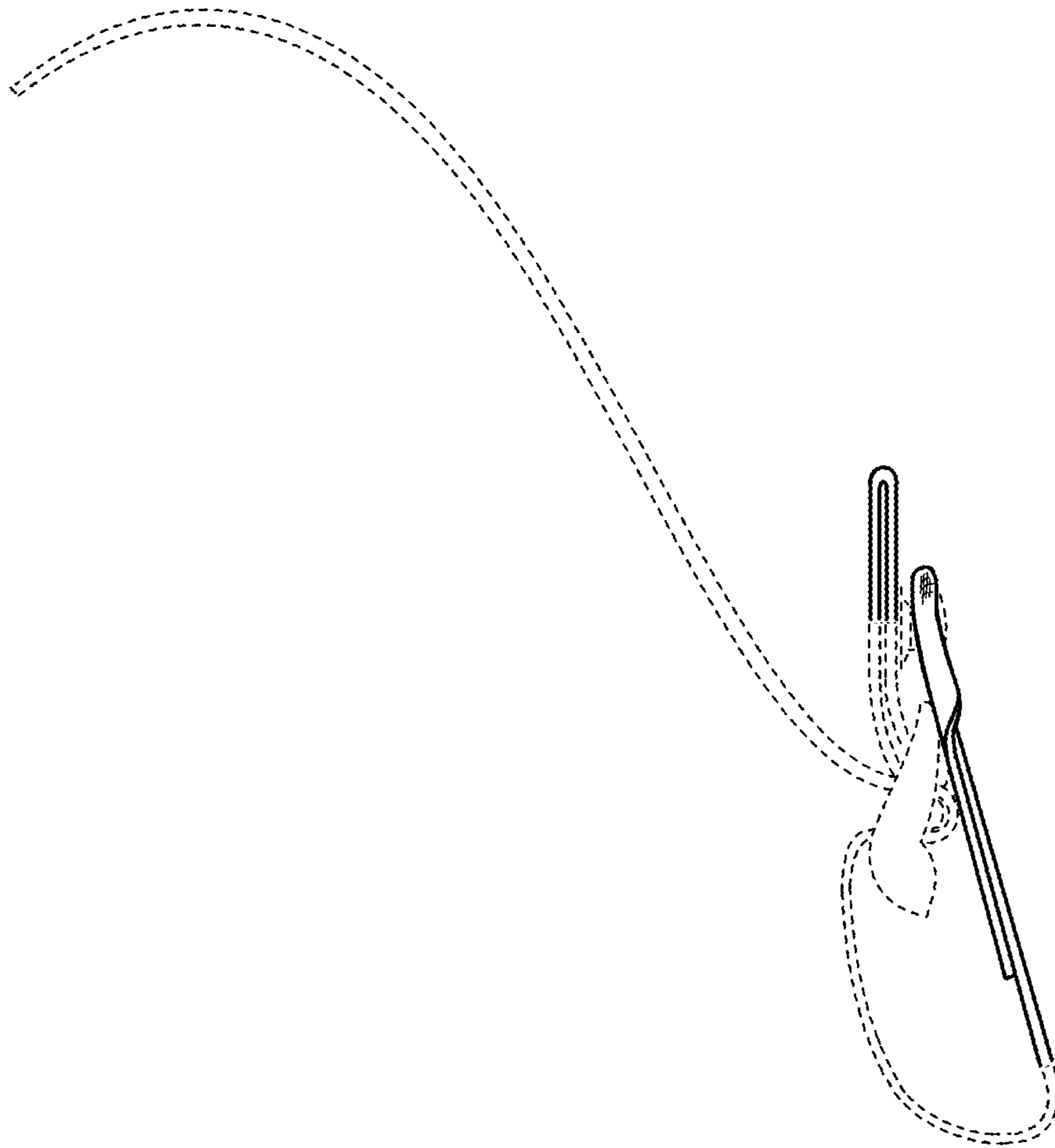
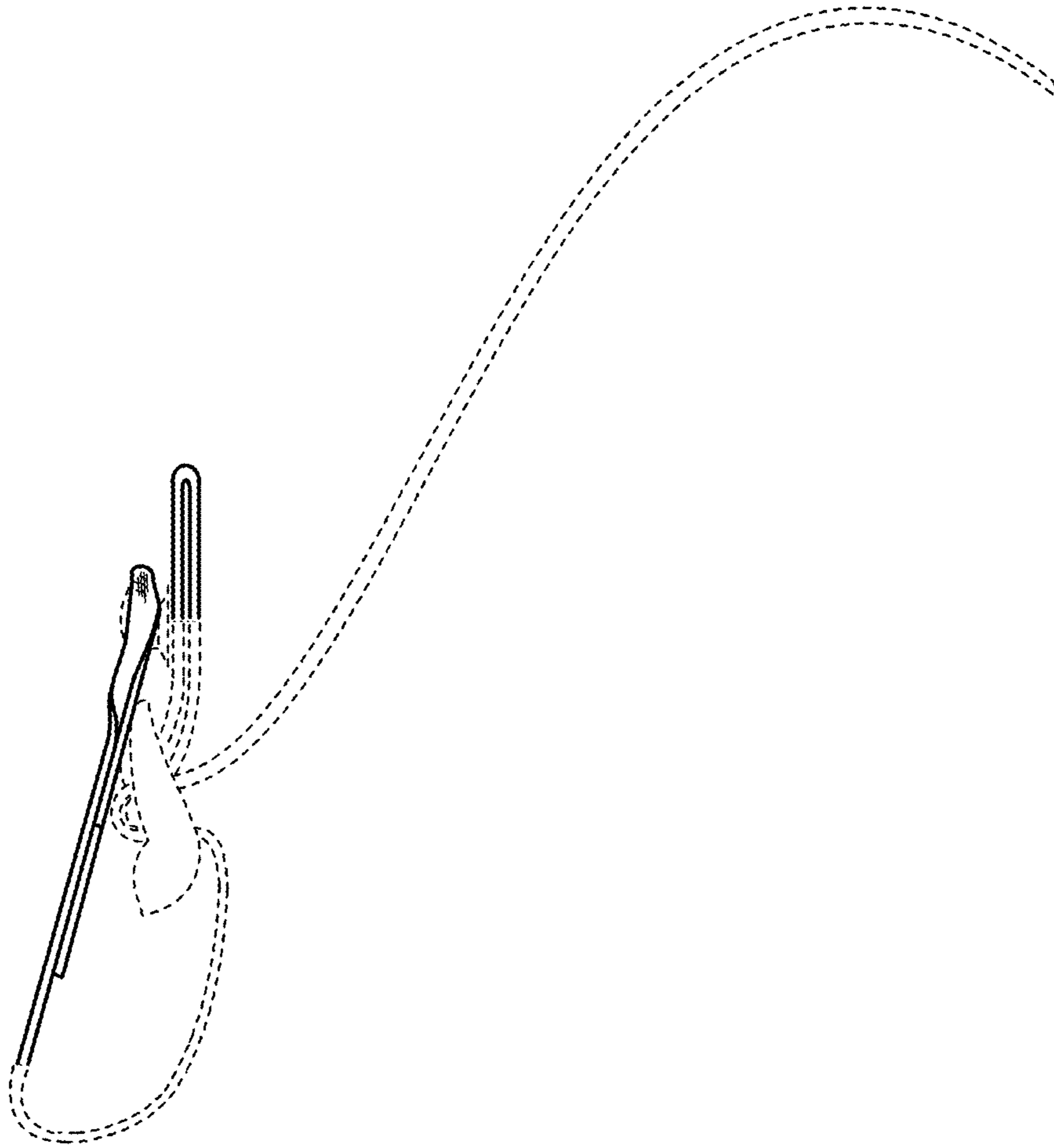

FIG. 43



**FIG. 44**



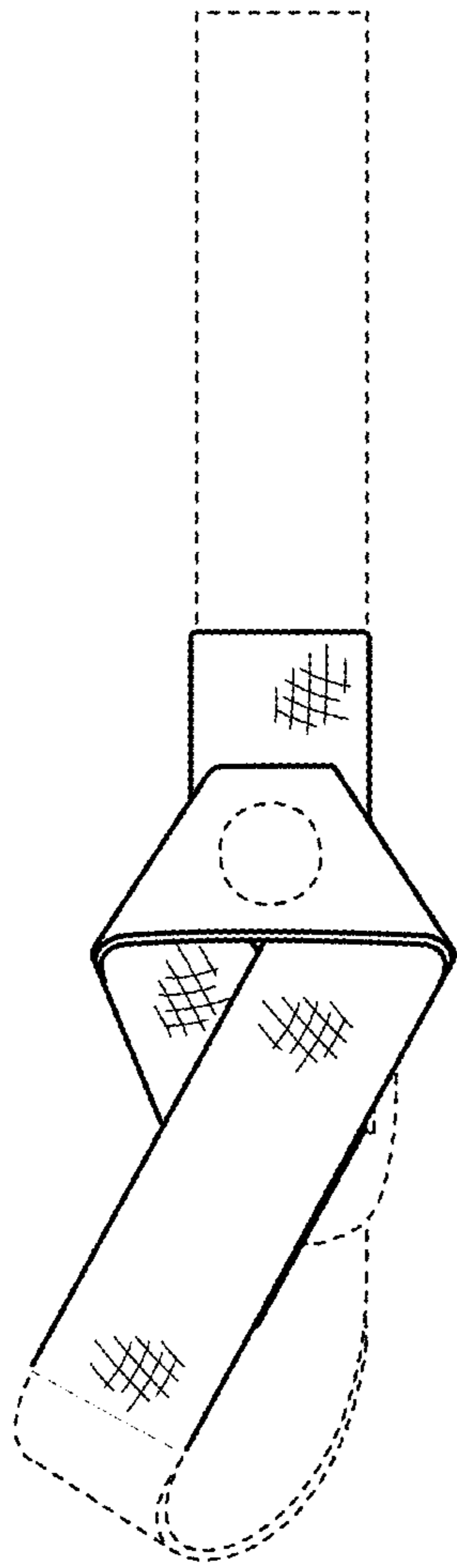

FIG. 45

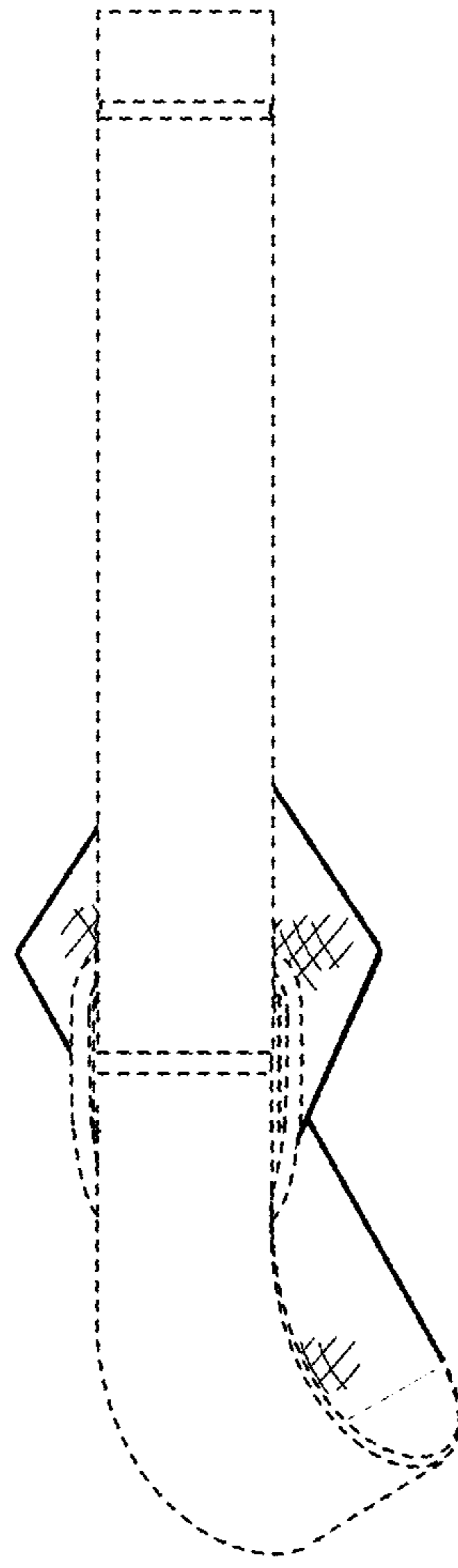

FIG. 46



FIG. 47

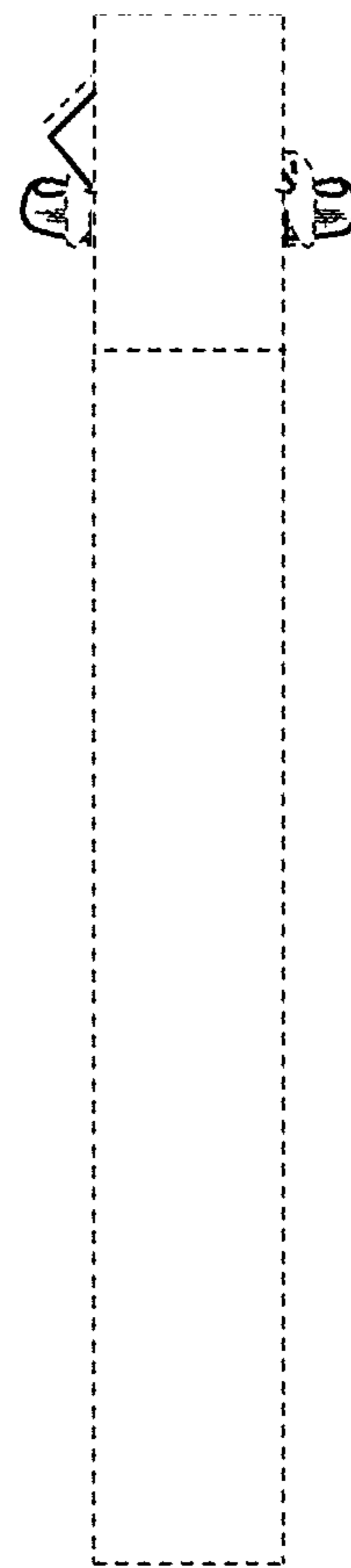

FIG. 48