



US00D790219S

(12) **United States Design Patent**
Huang

(10) **Patent No.: US D790,219 S**
(45) **Date of Patent: ** Jun. 27, 2017**

- (54) **TOOL BOX**
- (71) Applicant: **HUNG TAI PACKING DESIGN CO., LTD.**, Kaohsiung (TW)
- (72) Inventor: **Shou-Chi Huang**, Kaohsiung (TW)
- (73) Assignee: **Hung Tai Packing Design Co., Ltd.**, Kaohsiung (TW)

D536,171 S * 2/2007 Dong B65D 25/32
D3/273
D593,269 S * 5/2009 Weiler D32/53
D610,878 S * 3/2010 Kim D7/629
D614,949 S * 5/2010 Schmidt D9/424
D696,075 S * 12/2013 Mashike D7/605
D734,991 S * 7/2015 Carlson D7/602
D763,629 S * 8/2016 Swartz D7/629

- (**) Term: **15 Years**
- (21) Appl. No.: **29/551,945**
- (22) Filed: **Jan. 19, 2016**
- (51) **LOC (10) Cl.** **03-01**
- (52) **U.S. Cl.**
USPC **D3/276; D3/905**
- (58) **Field of Classification Search**
USPC D3/201, 203.1, 203.2, 203.6, 203.7,
D3/203.8, 202, 204, 205, 206, 247, 272,
D3/273, 276, 281, 282, 292, 294, 315,
D3/901, 903, 904, 905, 309, 304, 318;
D9/600, 643, 644, 645, 651, 655, 657,
D9/420, 423, 424, 425, 430, 431, 432,
D9/414; D14/480.1, 480.2, 480.3, 480.5;
D7/602, 605, 629, 538, 542; D32/53
CPC B65D 25/32; B65D 25/325; A45C 5/00;
A45C 5/04; B25H 3/00; B25H 3/02;
B25H 3/04; B25H 3/06
See application file for complete search history.

(56) **References Cited**
U.S. PATENT DOCUMENTS

D284,255 S * 6/1986 Carlson D7/605
4,989,744 A * 2/1991 Tominaga B65D 25/325
119/497
D330,161 S * 10/1992 Schuh D9/423
D373,021 S * 8/1996 Breen D3/276
D381,512 S * 7/1997 Green D3/273
D407,878 S * 4/1999 Carlson D32/53

OTHER PUBLICATIONS

Ebay.com. "6L Square Plastic Food Storage Container with Handle Lid Cannister Food Tub Box." Retrieved Dec. 15, 2016. (<http://www.ebay.co.uk/itm/6LSQUAREPLASTICFOODSTORAGECONTAINERWITHHANDLELIDCANNISTERFOODTUBBOX/220795115711>).*
Alibaba.com. "Square Plastic Handle Container with Lid Packaging Box." Retrieved Dec. 21, 2016. (https://www.alibaba.com/productdetail/SquarePlasticHandleContainerwithLid_60487981058.html).*

(Continued)

Primary Examiner — Jennifer Rivard
Assistant Examiner — Jerry Hsu
(74) *Attorney, Agent, or Firm* — Rosenberg, Klein & Lee

(57) **CLAIM**

The ornamental design for a tool box, as shown and described.

DESCRIPTION

FIG. 1 is a perspective view of a tool box showing my new design;
FIG. 2 is a front elevational view thereof;
FIG. 3 is a rear elevational view thereof;
FIG. 4 is a left side elevational view thereof;
FIG. 5 is a right side elevational view thereof;
FIG. 6 is a top plan view thereof; and,
FIG. 7 is a bottom plan view thereof.
The broken lines illustrate portions of the article and form no part of the claimed design.

1 Claim, 7 Drawing Sheets

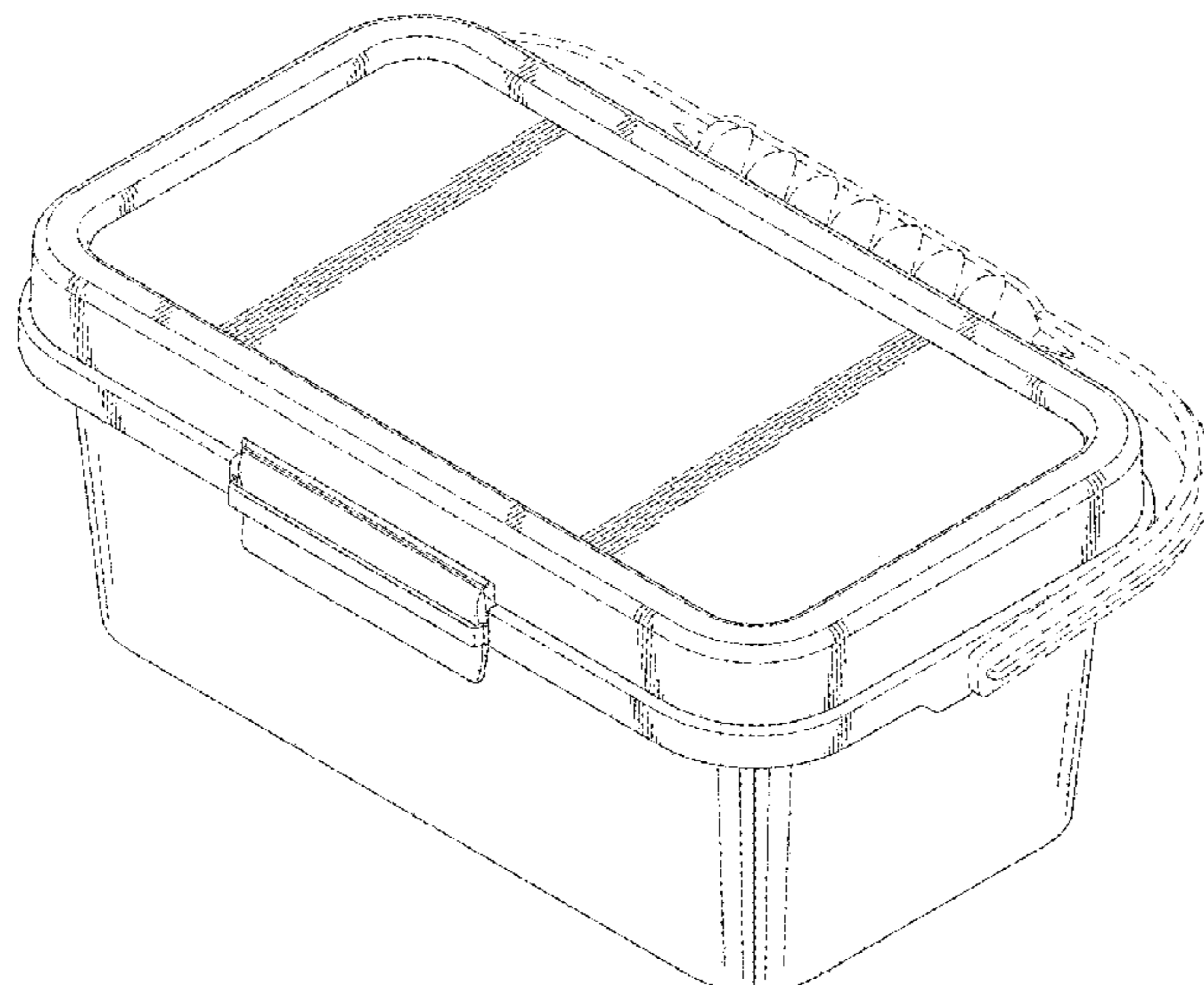

(56)

References Cited

OTHER PUBLICATIONS

Alibabab.com. "9L customized PP Square Plastic Bucket with Handle and Lid." Retrieved Dec. 21, 2016. (https://www.alibaba.com/productdetail/9LcustomizedPPsquareplasticbucket_60435873018.html).*

Trimplastics.co.za. "5LT PP Rectangular Plastic Bucket with White Lid." Retrieved Dec. 22, 2016. (<http://www.trimplastics.co.za/node/8>).*

* cited by examiner

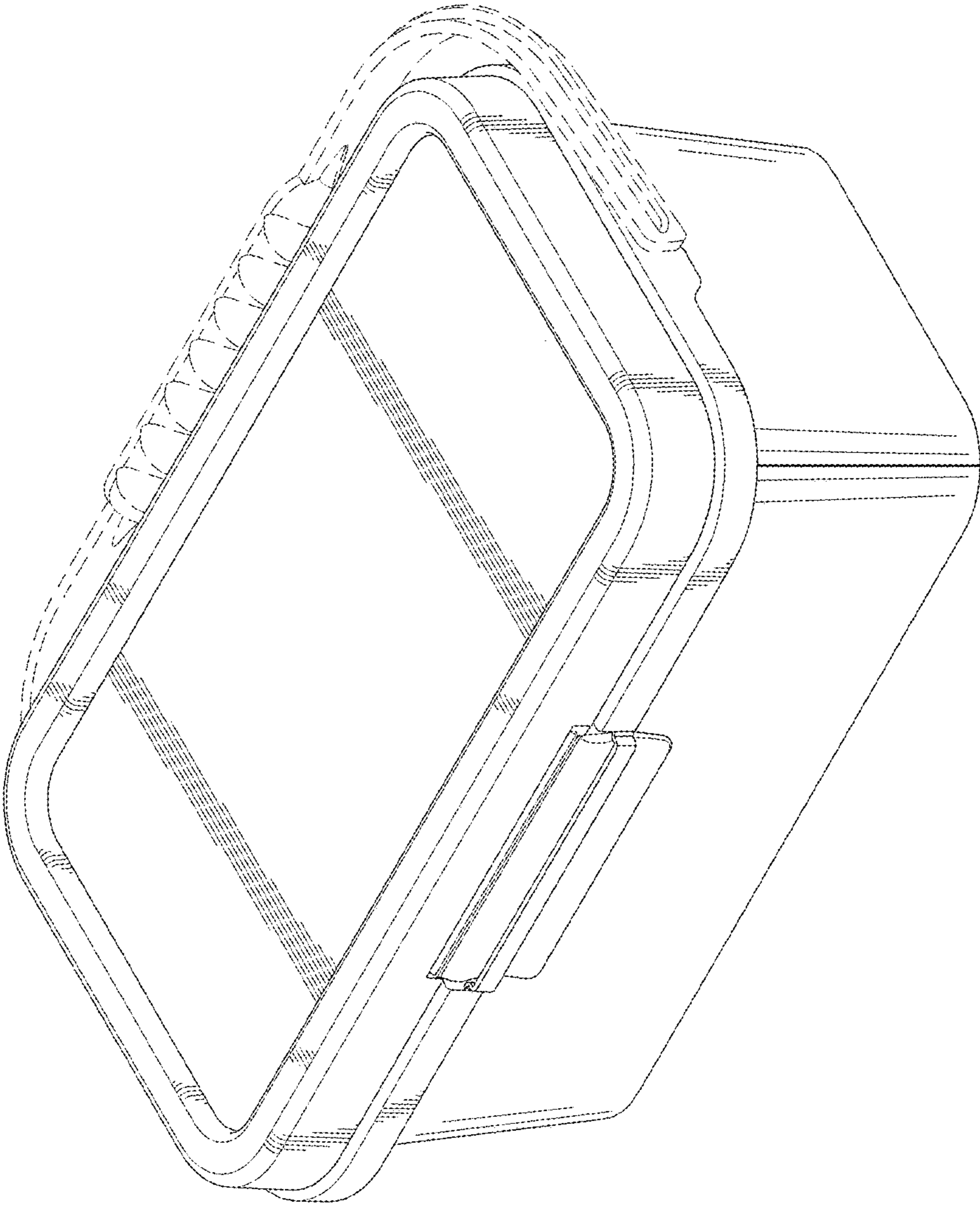

FIG. 1

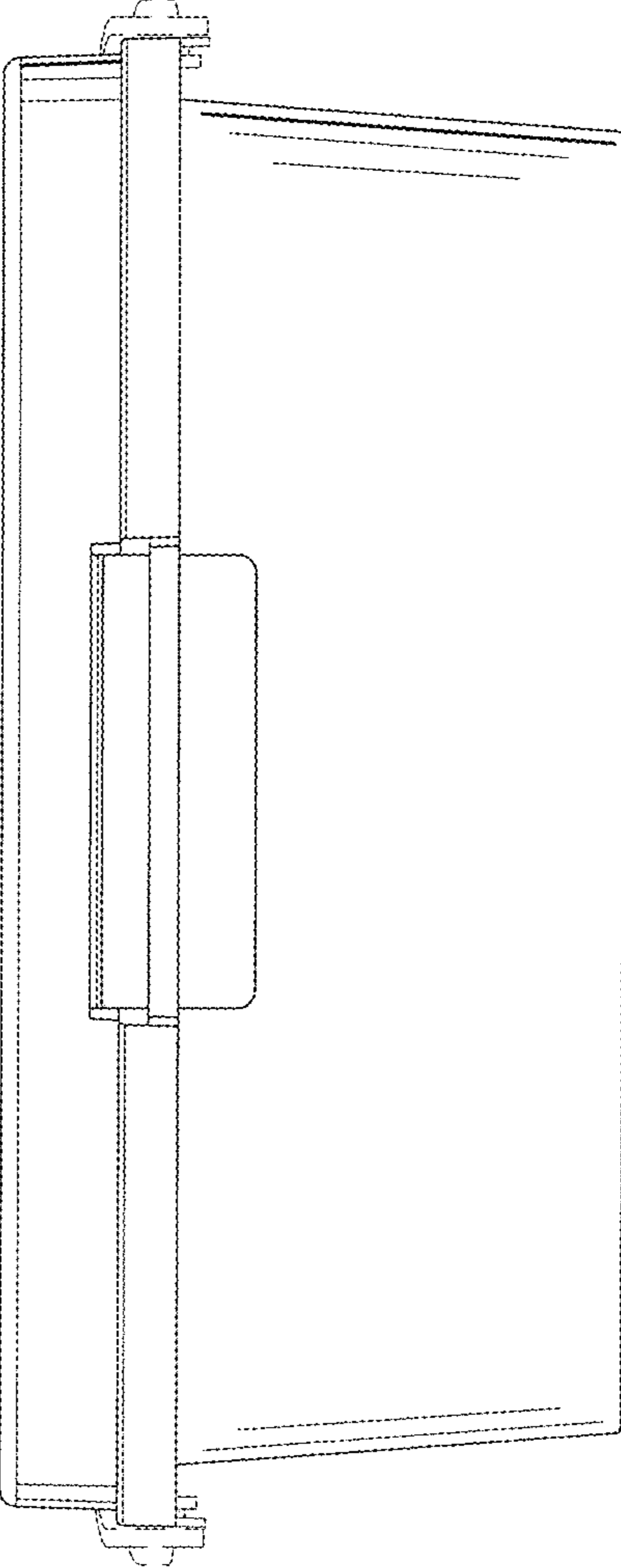

FIG. 2

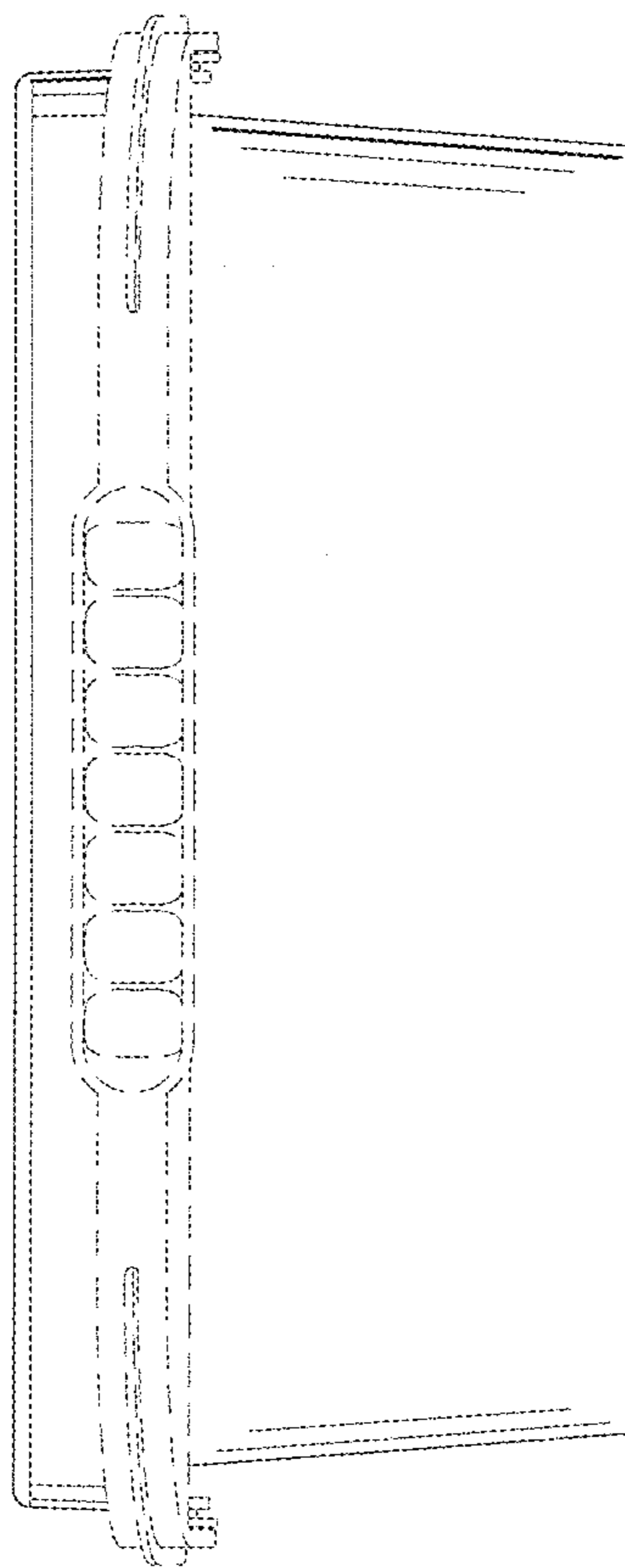

FIG. 3

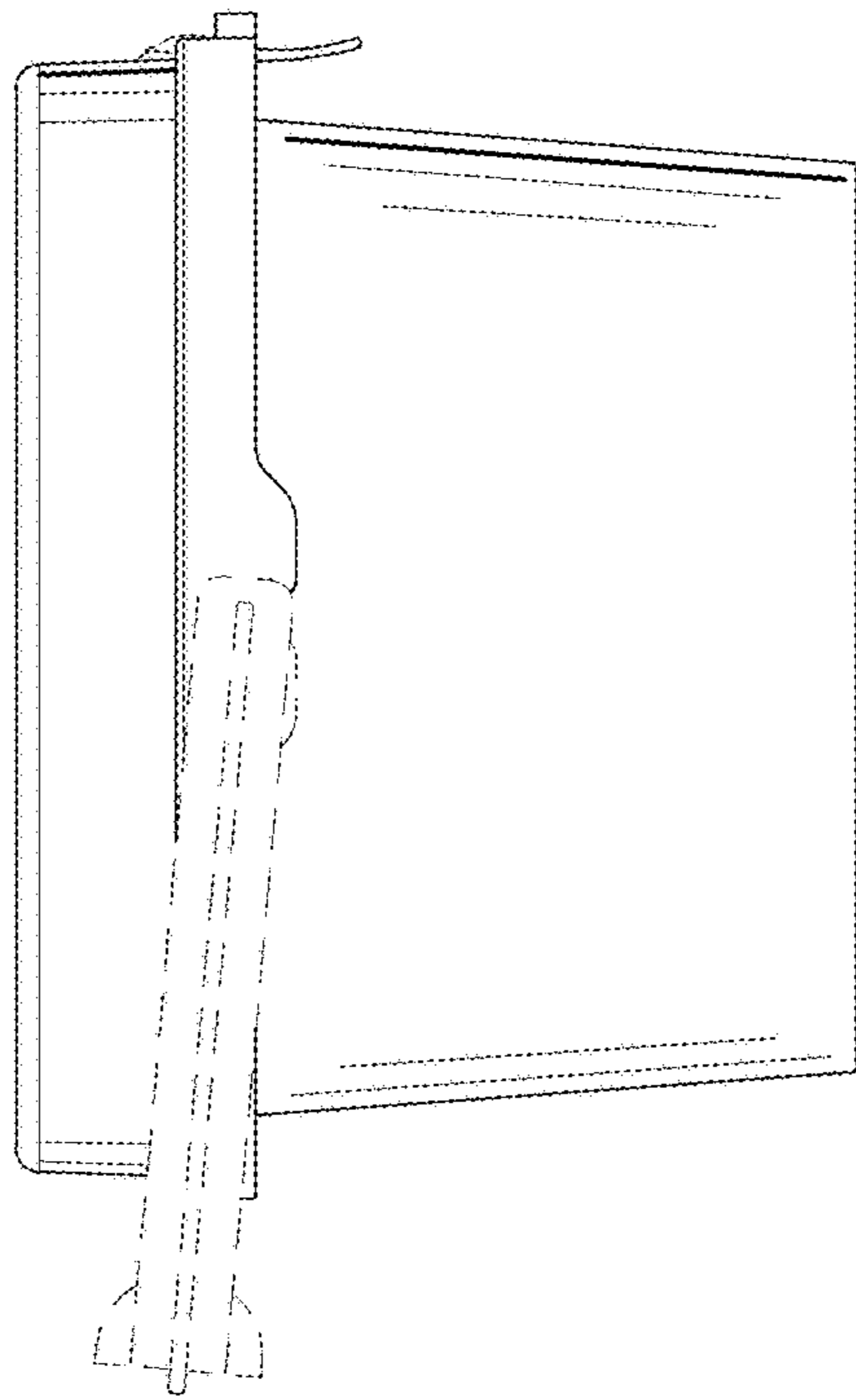

FIG. 4

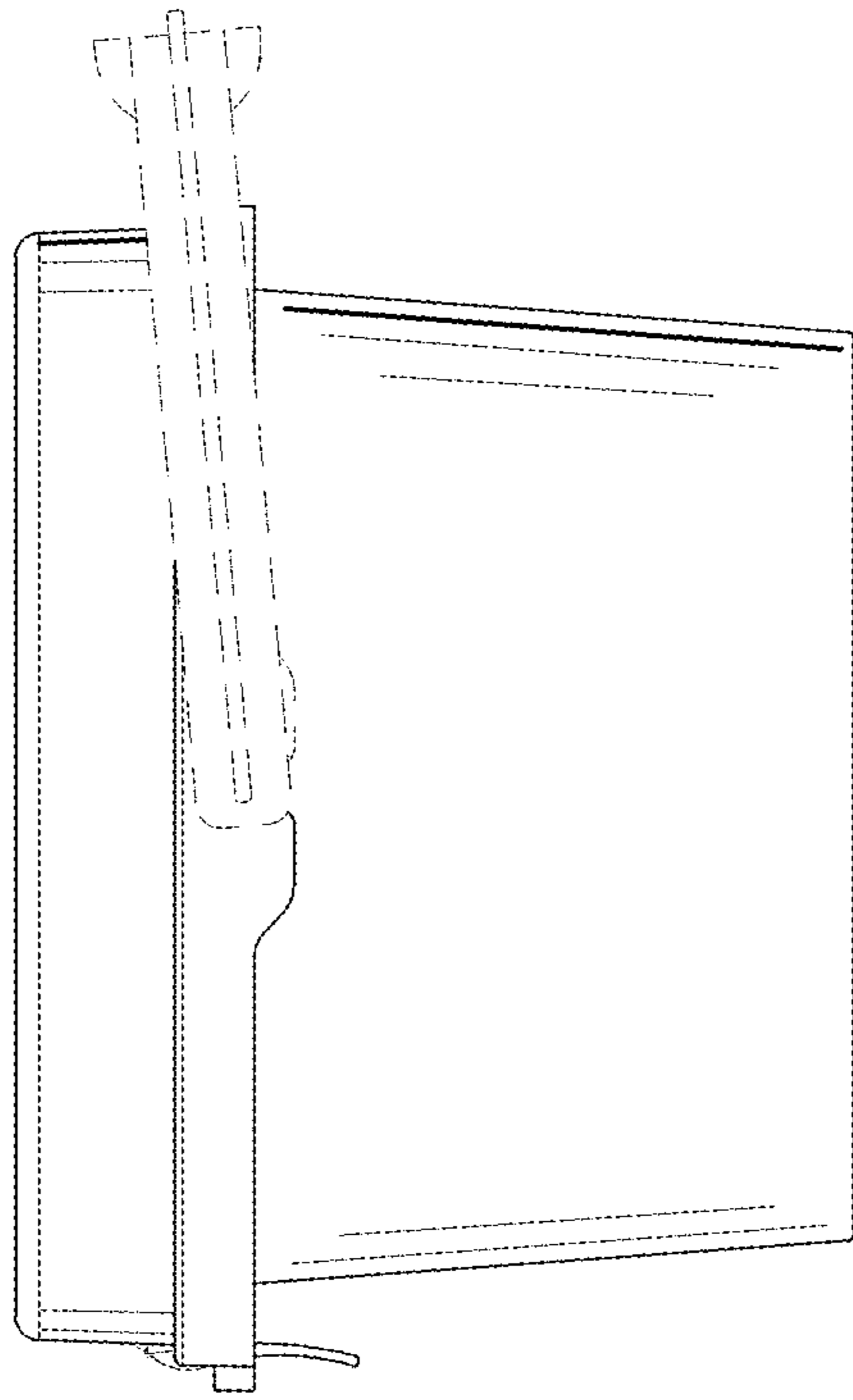

FIG. 5

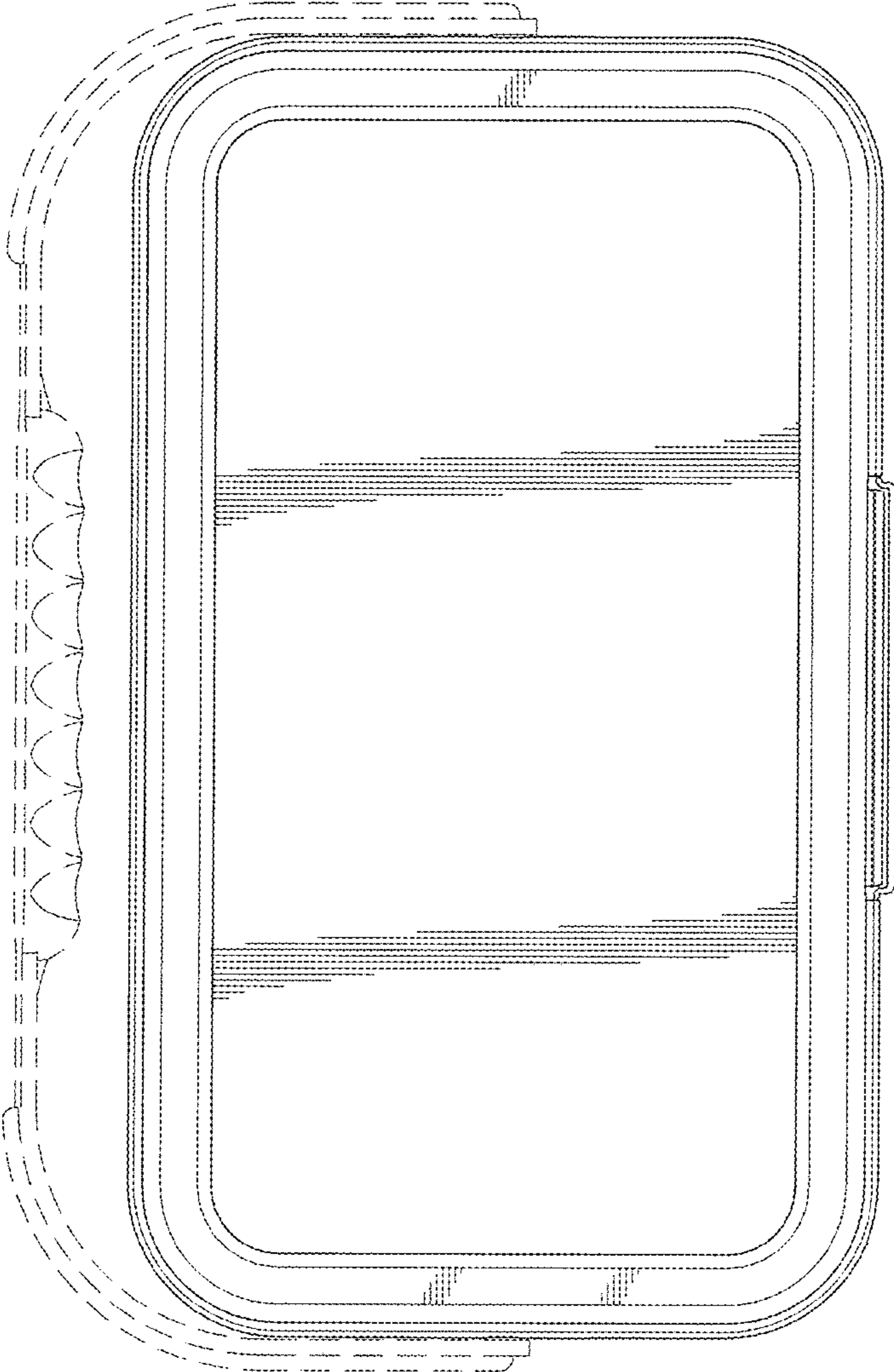

FIG. 6

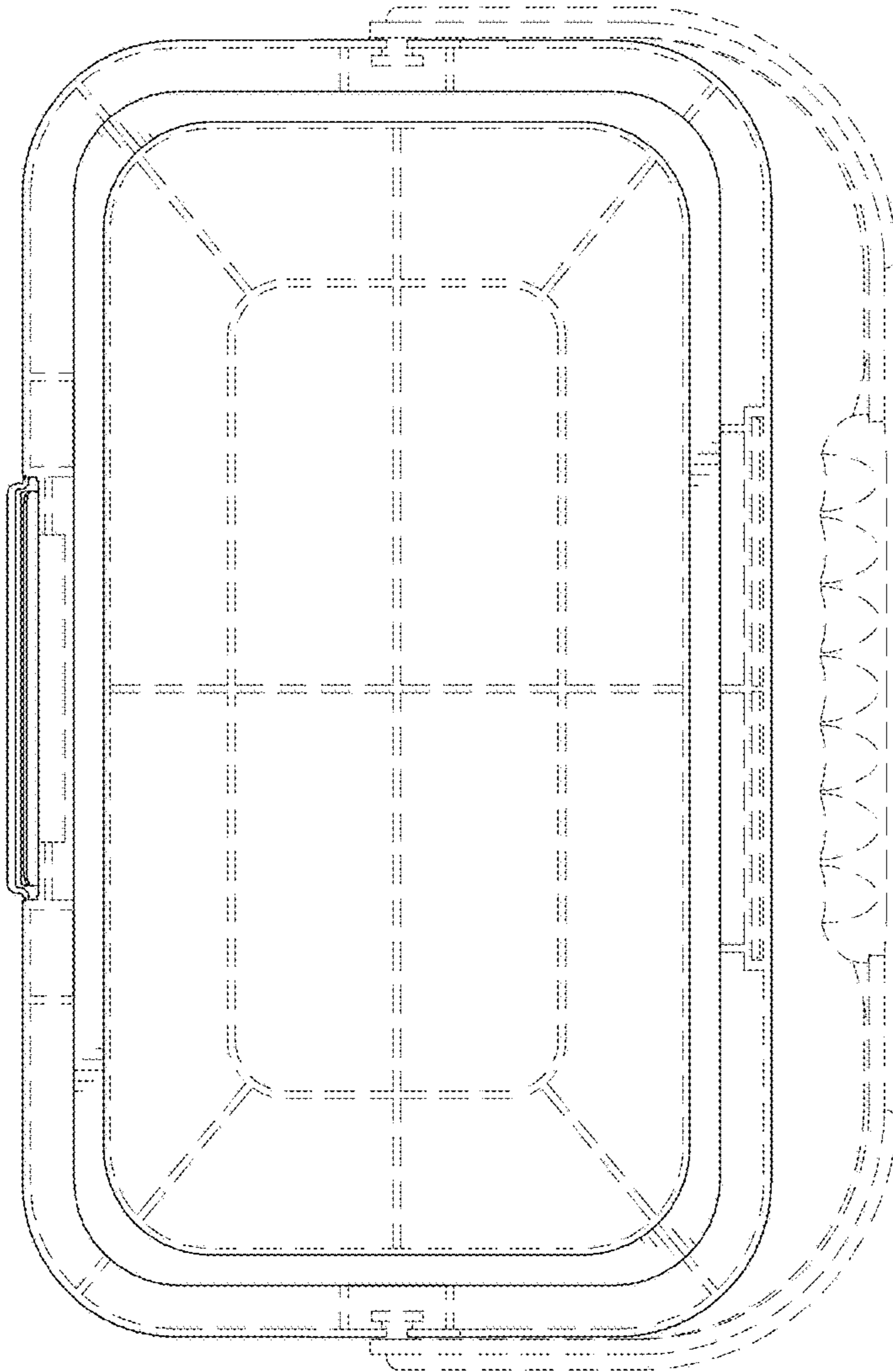

FIG. 7