



US00D790142S

(12) **United States Design Patent**
Carr et al.

(10) **Patent No.:** **US D790,142 S**

(45) **Date of Patent:** **** Jun. 20, 2017**

(54) **VACUUM CLEANER UPRIGHT PORTION**

(71) Applicant: **BISSELL Homecare, Inc.**, Grand Rapids, MI (US)

(72) Inventors: **Adam G. Carr**, Ada, MI (US); **Drew A. Johnson**, Coopersville, MI (US)

(73) Assignee: **BISSELL Homecare, Inc.**, Grand Rapids, MI (US)

(**) Term: **15 Years**

(21) Appl. No.: **29/548,881**

(22) Filed: **Dec. 17, 2015**

(51) **LOC (10) Cl.** **15-05**

(52) **U.S. Cl.**
USPC **D32/31**

(58) **Field of Classification Search**
USPC D32/17-18, 22, 31, 34, 45, 50-51;
D8/374, 323, 325

CPC A47L 5/24; A47L 5/28; A47L 5/34; A47L 7/0038; A47L 9/325; A47L 9/02; A47L 11/34; A47L 11/4086; A47L 13/26; A47L 13/225; A47L 13/22; B08B 9/0323; A23C 3/031

See application file for complete search history.

(56) **References Cited**

U.S. PATENT DOCUMENTS

D521,699 S * 5/2006 Greene D32/22
D662,271 S * 6/2012 Conrad D32/31

D662,272 S * 6/2012 Conrad D32/31
D685,961 S * 7/2013 Bilger D32/31
D739,620 S * 9/2015 Johnson D32/22
D740,505 S * 10/2015 Gidwell D32/31
D769,557 S * 10/2016 Johnson D32/22
D770,106 S * 10/2016 Johnson D32/22

* cited by examiner

Primary Examiner — Ruth McInroy

(74) *Attorney, Agent, or Firm* — McGarry Bair PC

(57) **CLAIM**

The ornamental design for a vacuum cleaner upright portion, as shown and described.

DESCRIPTION

FIG. 1 is a front and right-side perspective view of a vacuum cleaner upright portion showing our new design; FIG. 2 is a front view thereof; FIG. 3 is a rear view thereof; FIG. 4 is a left side view thereof; FIG. 5 is a right side view thereof; and, FIG. 6 is an enlarged top view thereof. The broken lines are shown for the purpose of illustrating unclaimed portions of the vacuum cleaner upright portion and form no part of the claimed design.

1 Claim, 4 Drawing Sheets

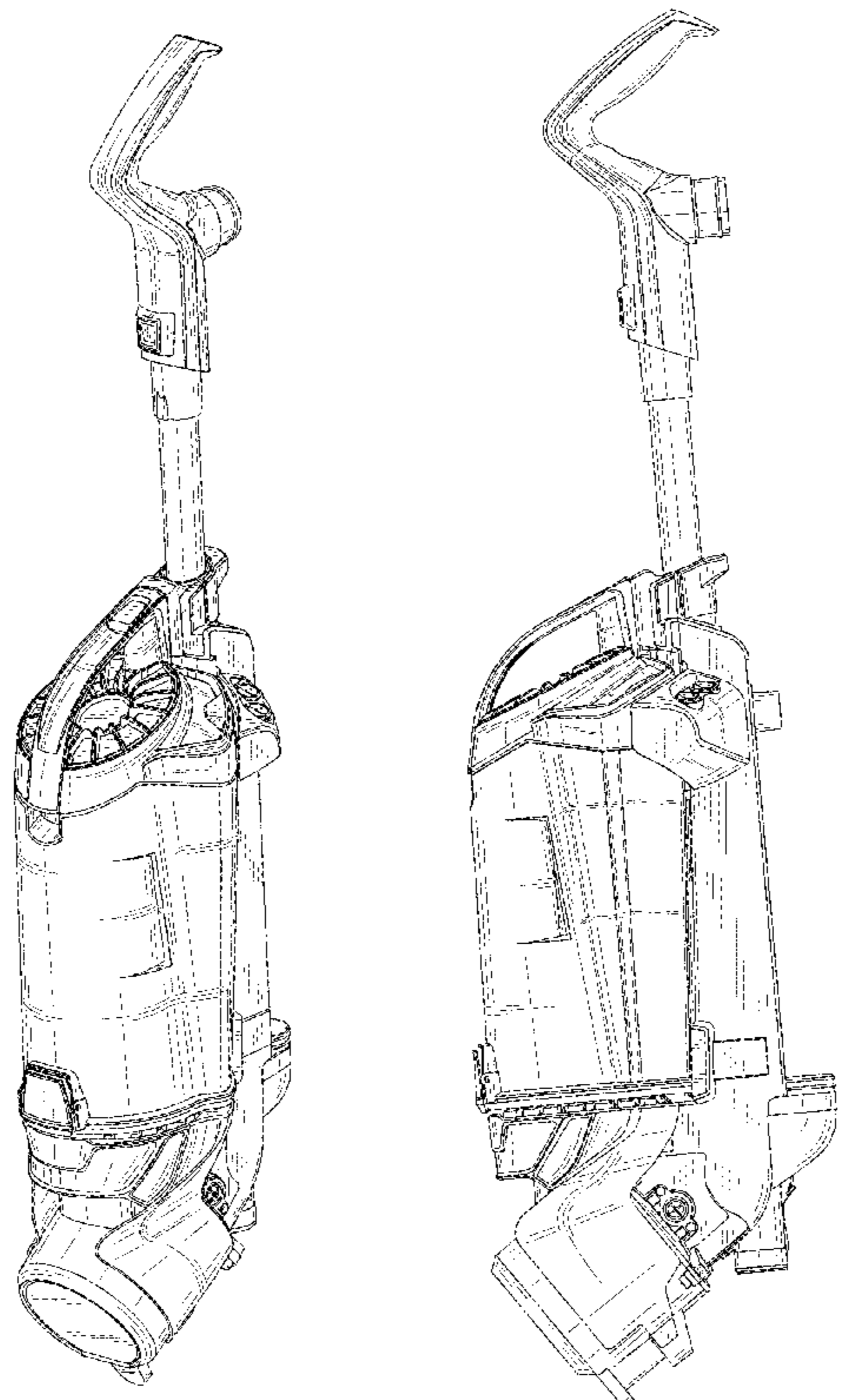

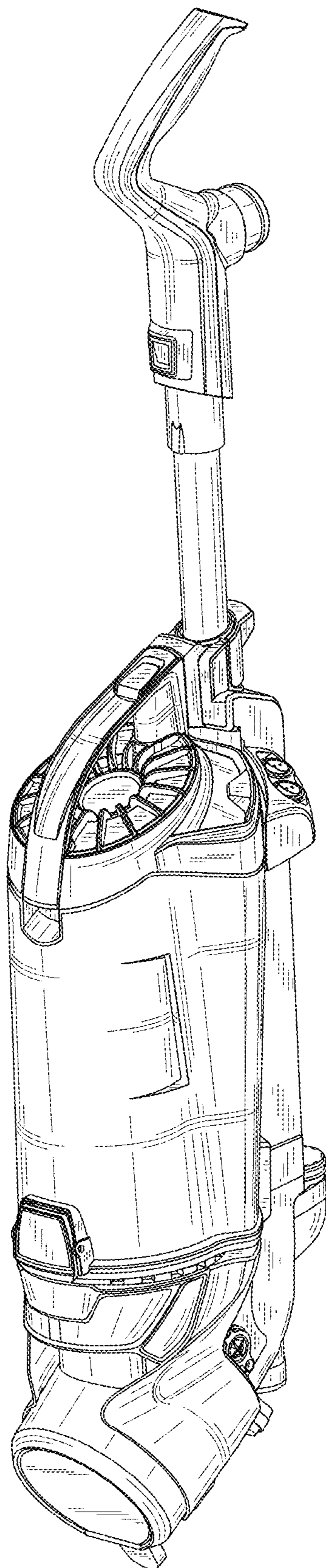

FIG. 1

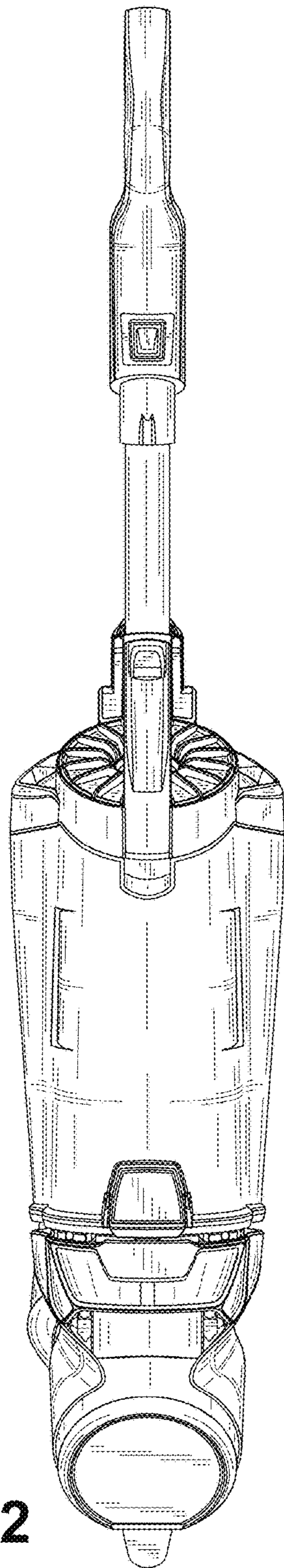

FIG. 2

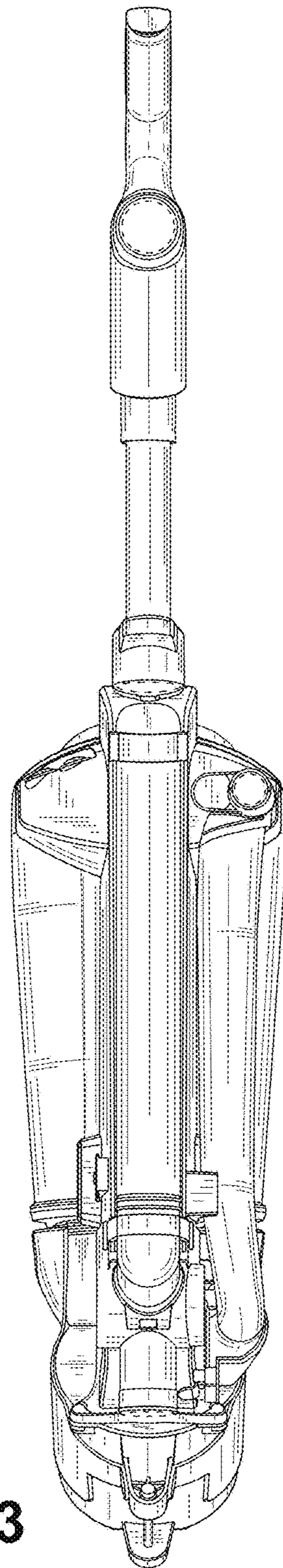

FIG. 3

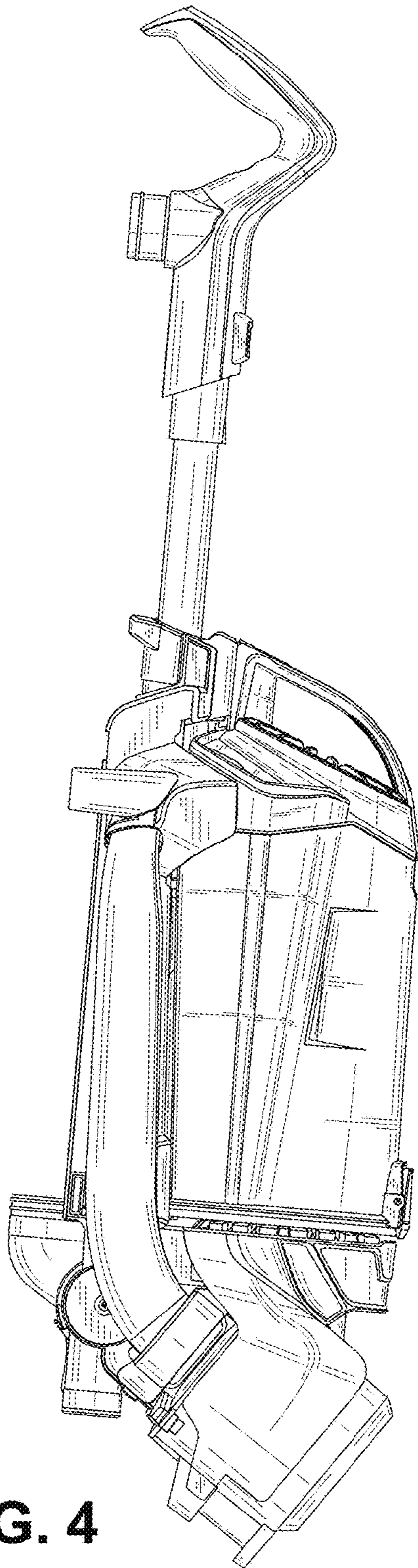

FIG. 4

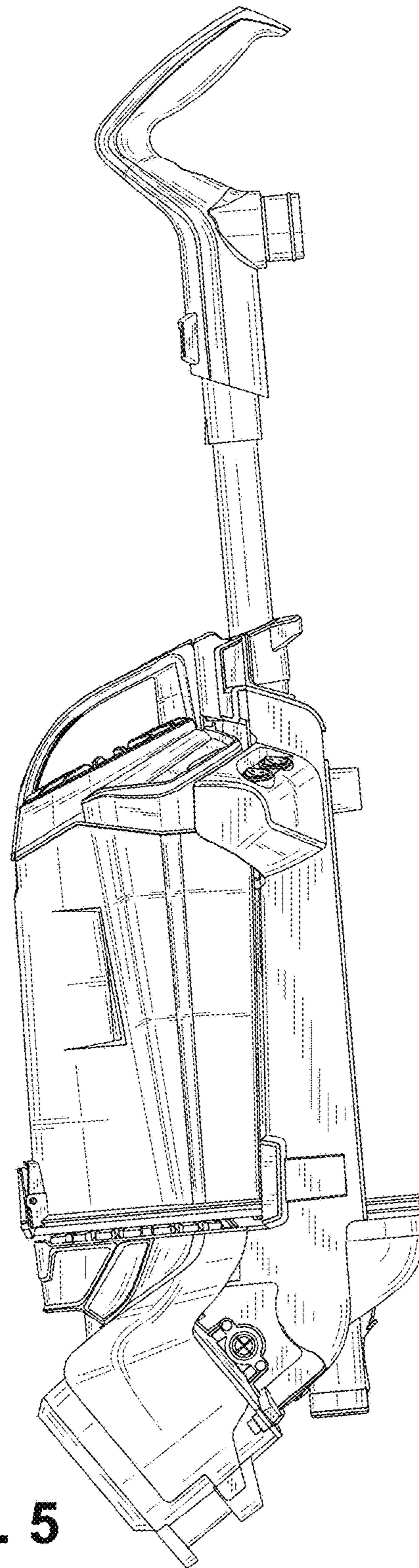

FIG. 5

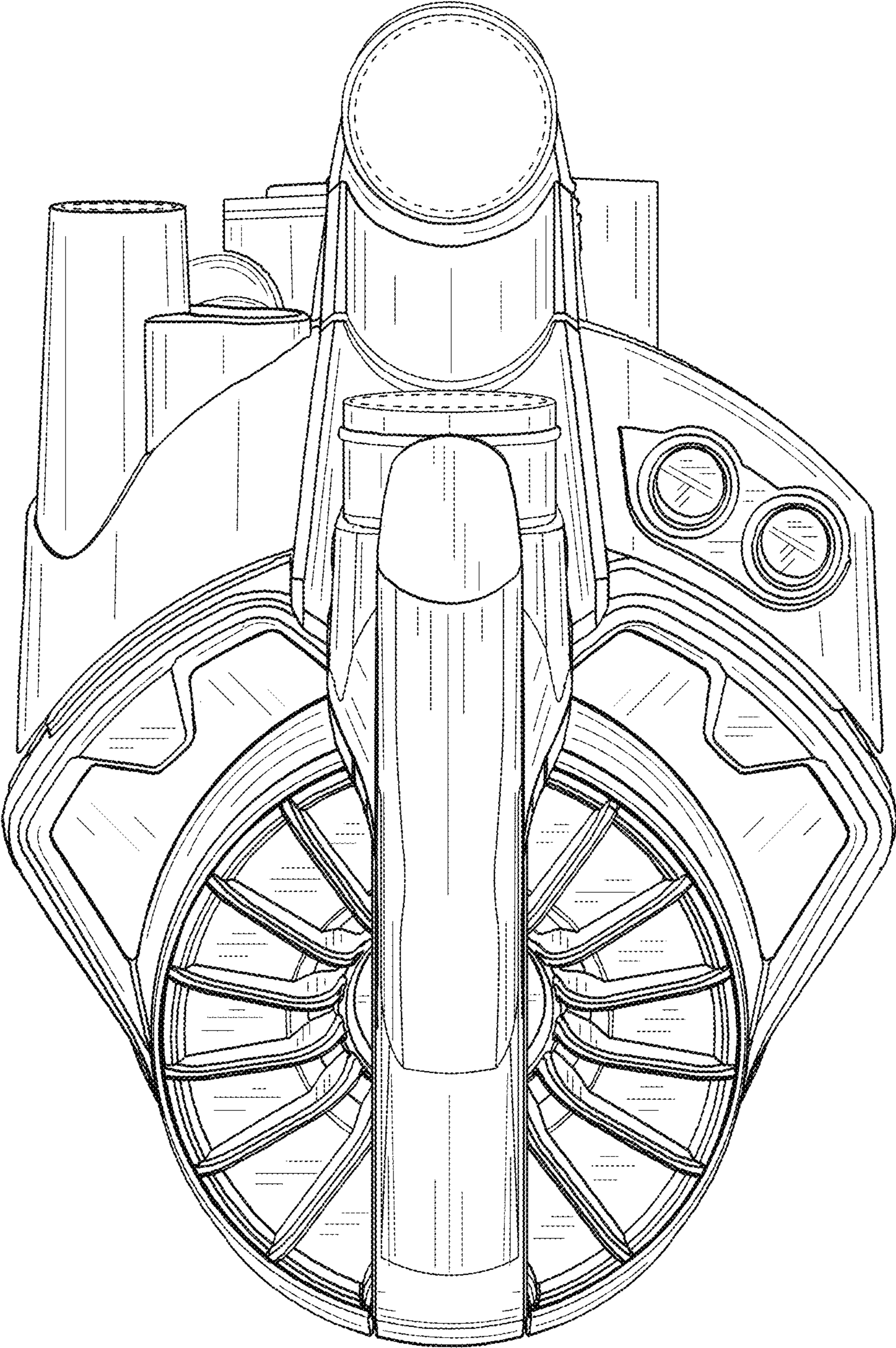

FIG. 6