



US00D790029S

(12) **United States Design Patent** (10) **Patent No.:** **US D790,029 S**  
**Geissele** (45) **Date of Patent:** **\*\* Jun. 20, 2017**

(54) **FIREARM RAIL**

(71) Applicant: **WHG Properties, LLC**, North Wales, PA (US)

(72) Inventor: **William H. Geissele**, Lower Gwynedd, PA (US)

(73) Assignee: **WHG Properties, LLC**, North Wales, PA (US)

(\*\*) Term: **15 Years**

(21) Appl. No.: **29/554,079**

(22) Filed: **Feb. 8, 2016**

**Related U.S. Application Data**

(62) Division of application No. 29/510,028, filed on Nov. 24, 2014, now Pat. No. Des. 754,274.

(51) **LOC (10) Cl.** ..... **22-01**

(52) **U.S. Cl.**  
USPC ..... **D22/108**

(58) **Field of Classification Search**  
USPC ..... D22/103, 108  
CPC ..... F41C 23/16; F41A 35/02  
See application file for complete search history.

(56) **References Cited**

**U.S. PATENT DOCUMENTS**

D607,958 S *	1/2010	Swan	.....	D22/108
8,464,457 B2 *	6/2013	Troy	.....	F41C 23/16 42/71.01
D709,582 S *	7/2014	Geissele	.....	D22/108
D716,902 S	11/2014	Nason		
D717,908 S	11/2014	Montes		
D721,407 S	1/2015	Chu		
D745,104 S	12/2015	Eitan		
D745,621 S	12/2015	Huang		

D754,274 S *	4/2016	Geissele	.....	D22/108
D770,590 S *	11/2016	Sui	.....	D22/108
D773,590 S *	12/2016	Wingate	.....	D22/108
2012/0198990 A1 *	8/2012	Brittin	.....	F41A 5/26 89/191.01
2014/0115939 A1 *	5/2014	Troy	.....	F41C 23/16 42/72
2014/0130390 A1 *	5/2014	Geissele	.....	F41C 23/16 42/71.01
2014/0144059 A1	5/2014	Geissele		
2015/0266168 A1	9/2015	Geissele		
2015/0316347 A1 *	11/2015	Shea	.....	F41C 23/16 42/75.02

\* cited by examiner

*Primary Examiner* — Michael A Pratt

(74) *Attorney, Agent, or Firm* — Merchant & Gould, P.C.

(57) **CLAIM**

The ornamental design for a firearm rail, as shown and described.

**DESCRIPTION**

FIG. 1 is a front left isometric view of a firearm rail according to the present disclosure;  
FIG. 2 is an enlarged front elevation view of the firearm rail of FIG. 1;  
FIG. 3 is an enlarged rear elevation view of the firearm rail of FIG. 1;  
FIG. 4 is a right side elevation view of the firearm rail of FIG. 1;  
FIG. 5 is a left side elevation view of the firearm rail of FIG. 1;  
FIG. 6 is a top view of the firearm rail of FIG. 1; and,  
FIG. 7 is a bottom view of the firearm rail of FIG. 1.  
The broken lines in the Figures are for illustrative purposes only and form no part of the claimed design.

**1 Claim, 4 Drawing Sheets**

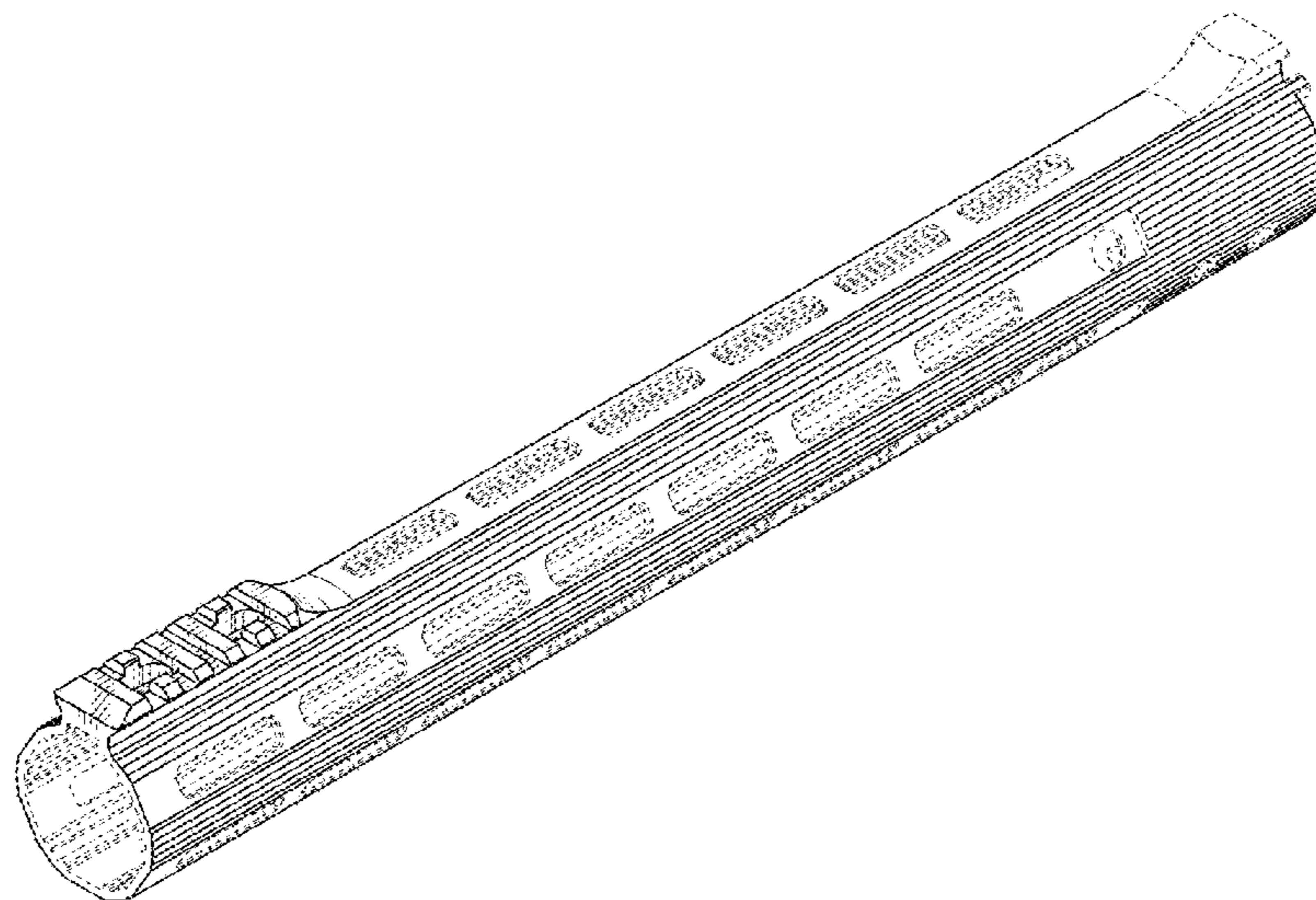

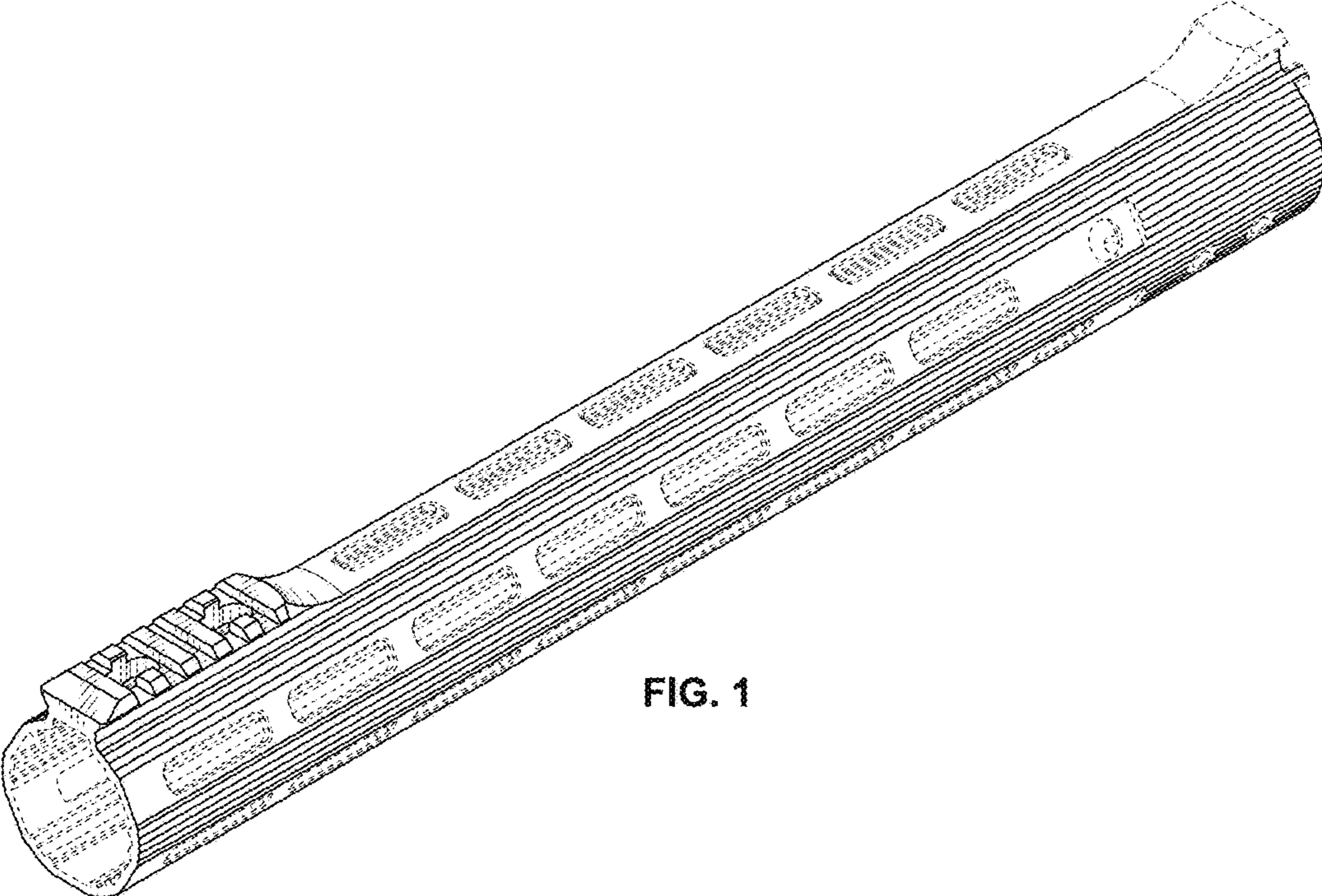

FIG. 1

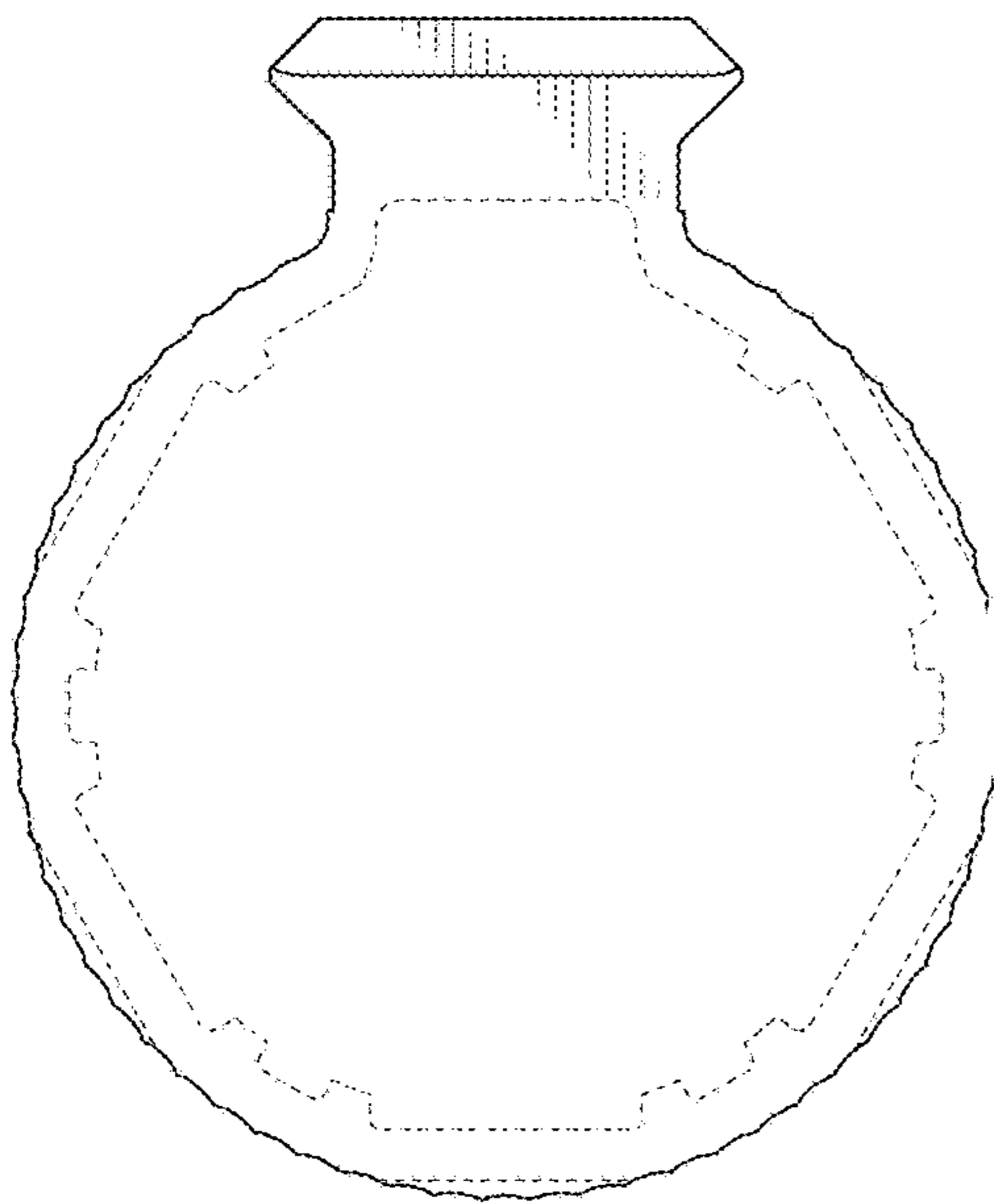

FIG. 2

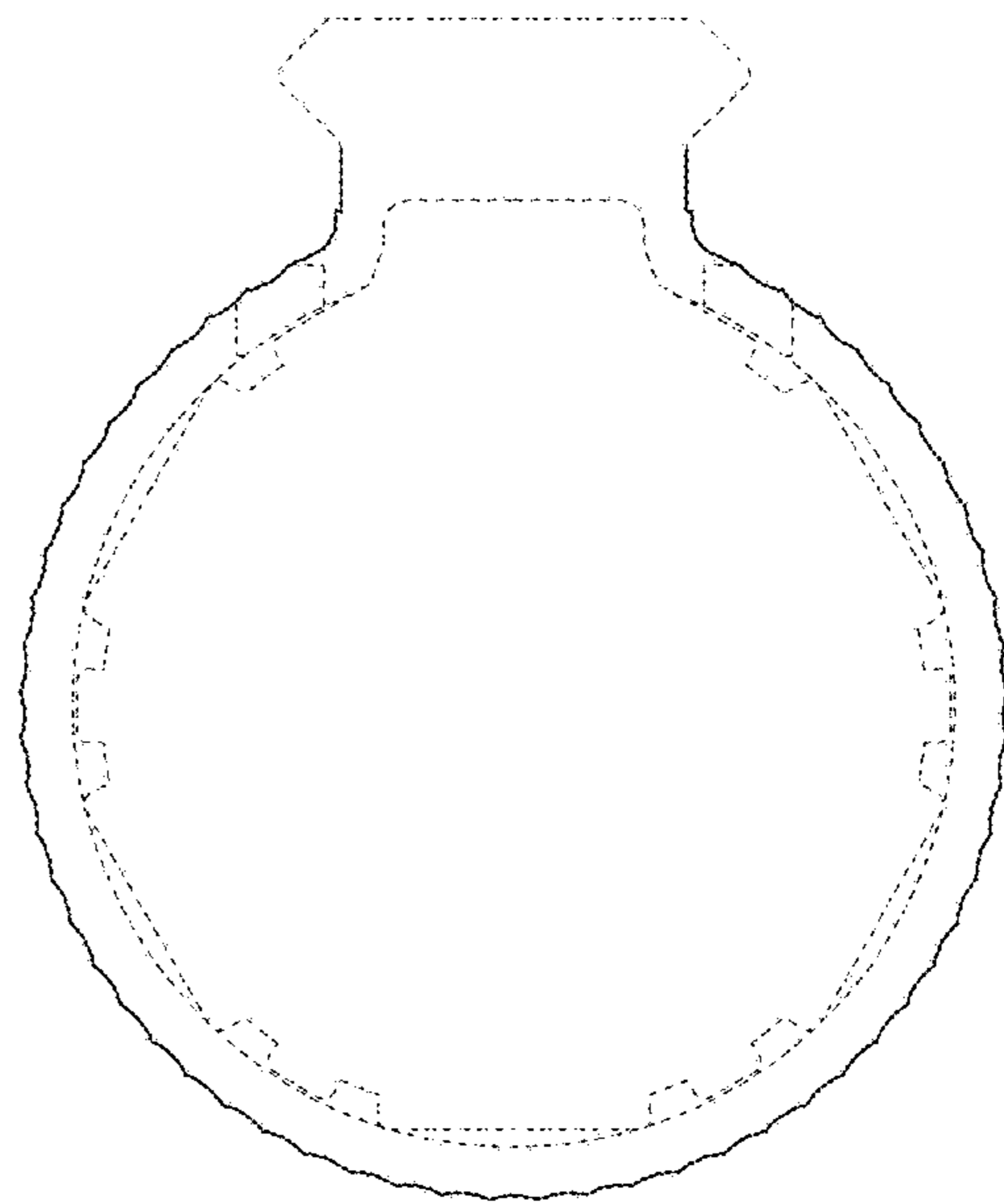

FIG. 3

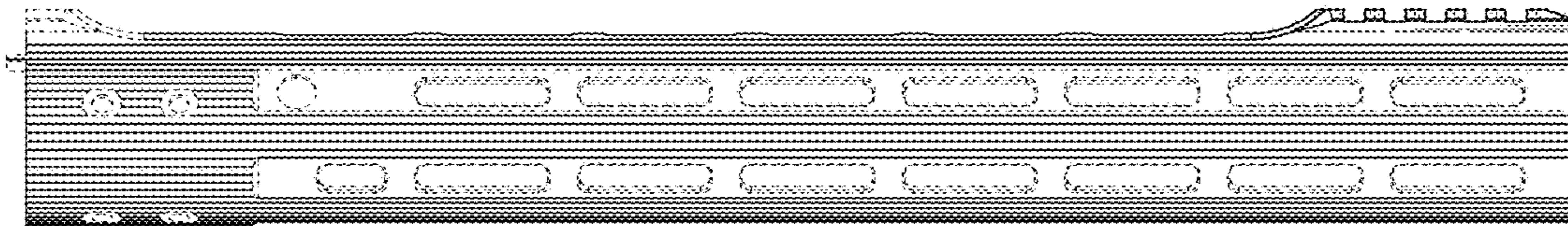

FIG. 4

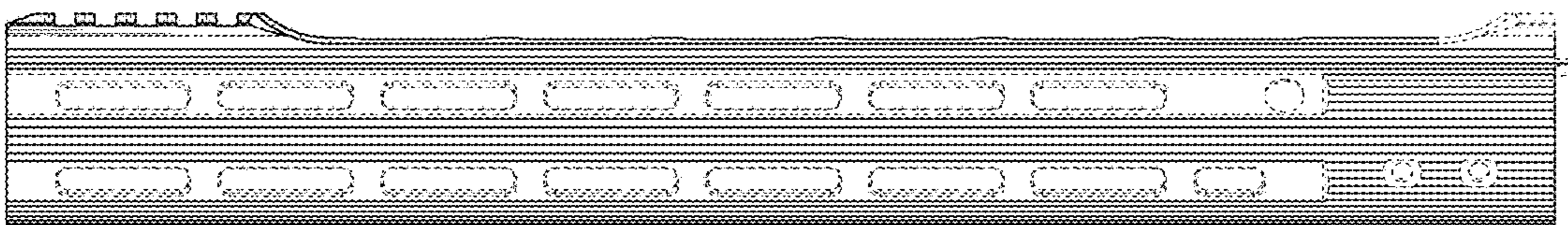

FIG. 5

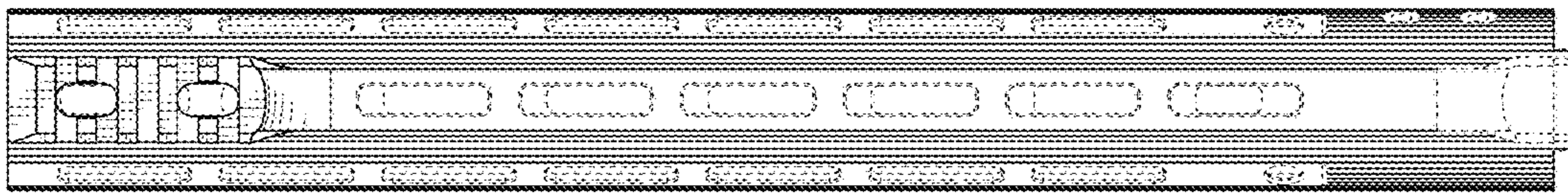

FIG. 6

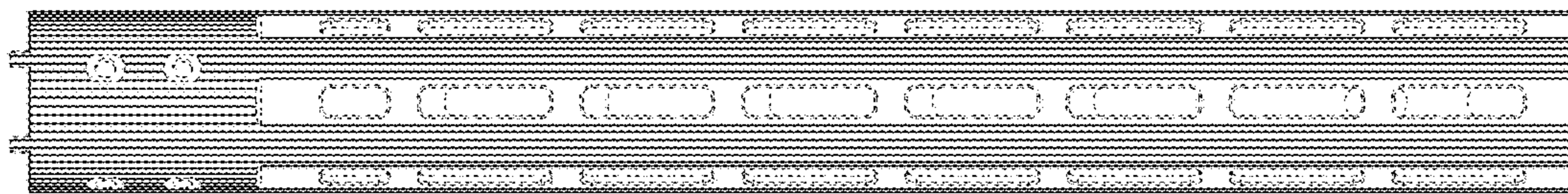

FIG. 7