



US00D790015S

(12) **United States Design Patent**
Tan

(10) **Patent No.:** **US D790,015 S**

(45) **Date of Patent:** **** Jun. 20, 2017**

(54) **SKATEBOARD**

(71) Applicant: **DYNAMIC LABS, LLC**, Los Angeles, CA (US)

(72) Inventor: **Andrew Paolo Belandres Tan**, Los Angeles, CA (US)

(73) Assignee: **Dynamic Labs, LLC**, Los Angeles, CA (US)

(**) Term: **15 Years**

(21) Appl. No.: **29/558,766**

(22) Filed: **Mar. 21, 2016**

(51) **LOC (10) Cl.** **21-02**

(52) **U.S. Cl.**
USPC **D21/765**

(58) **Field of Classification Search**

USPC D21/419, 421, 423, 426, 662, 760, 765, D21/766, 769, 771, 776, 803; D12/1; 280/7.14, 11.115, 11.19, 11.27, 11.28, 280/14.21, 79.11, 79.2, 87.01, 87.021, 280/87.03, 87.041, 87.042, 607, 608, 609, 280/809; 180/180, 181; 434/247, 253, 434/258; D34/23, 28
CPC A63C 17/01; A63C 17/011; A63C 17/012; A63C 17/014; A63C 17/015; A63C 17/02; A63C 17/26; A63C 5/003; B60Q 1/326; B62K 3/001

See application file for complete search history.

(56) **References Cited**

U.S. PATENT DOCUMENTS

D422,662 S * 4/2000 Edwards D21/765
D583,006 S * 12/2008 Hennings, III D21/801
D607,525 S * 1/2010 Marciano D21/769
2012/0007331 A1* 1/2012 Hsieh A63C 17/0033
280/221

* cited by examiner

Primary Examiner — Cynthia M Chin

(74) *Attorney, Agent, or Firm* — Lewis Roca Rothgerber Christie LLP

(57) **CLAIM**

The ornamental design for a skateboard, as shown and described.

DESCRIPTION

FIG. 1 is an upper perspective view of a skateboard showing the claimed design;

FIG. 2 is a lower perspective view thereof;

FIG. 3 is a top view thereof;

FIG. 4 is a bottom view thereof;

FIG. 5 is a side view thereof;

FIG. 6 is a front view thereof; and,

FIG. 7 is a back view thereof.

The broken lines depict environmental structure that forms no part of the claimed design.

1 Claim, 5 Drawing Sheets

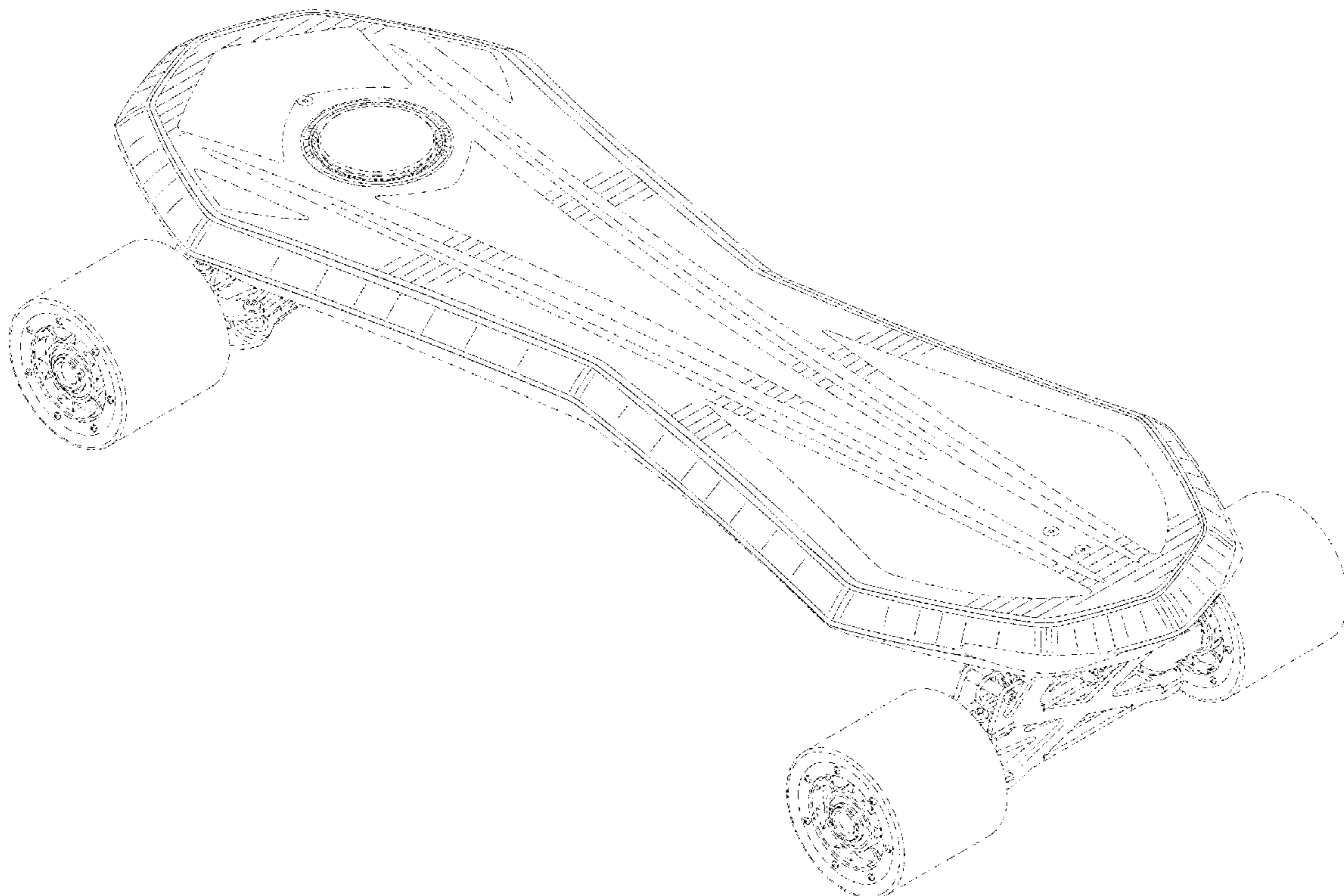
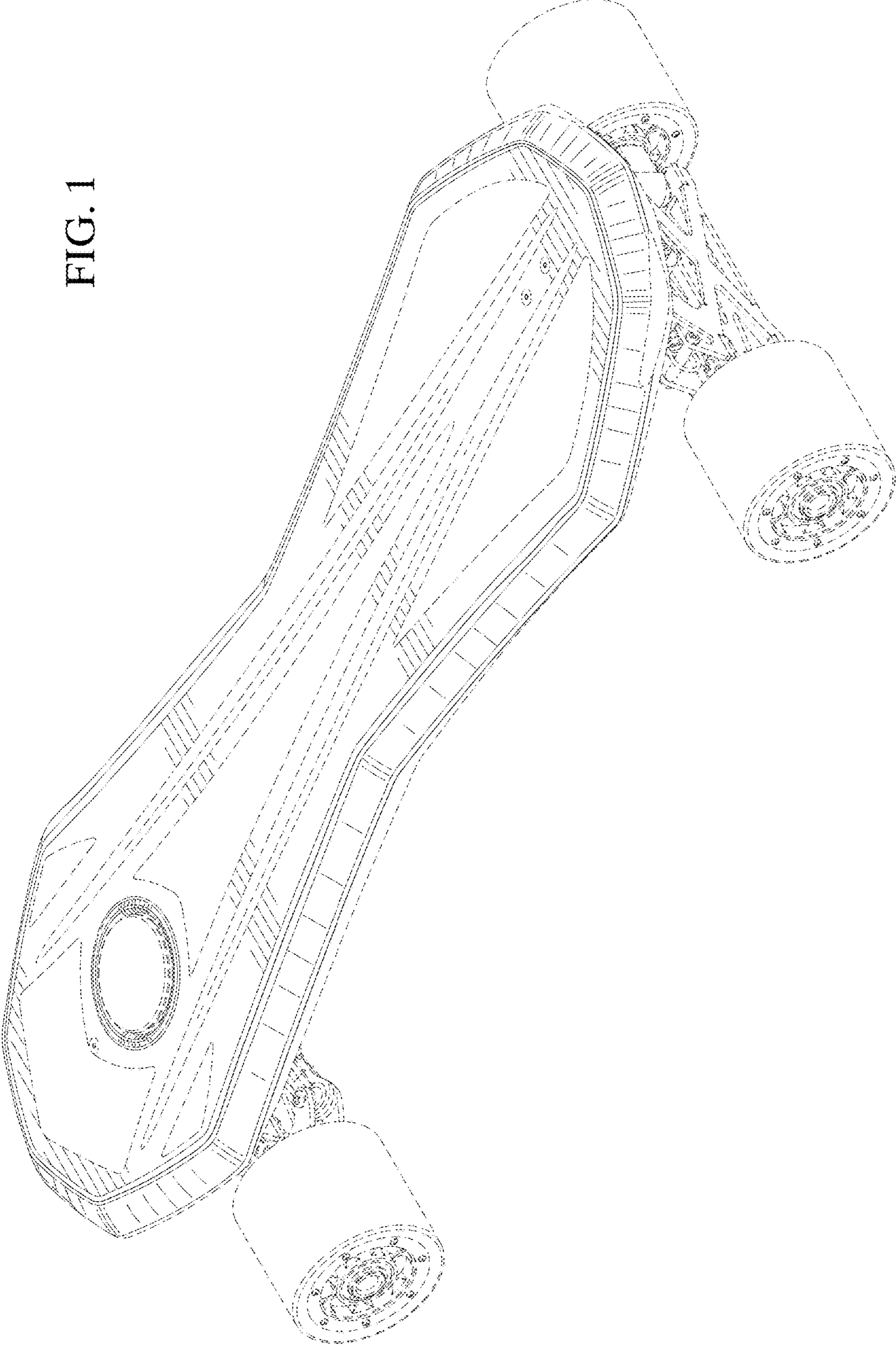

FIG. 1



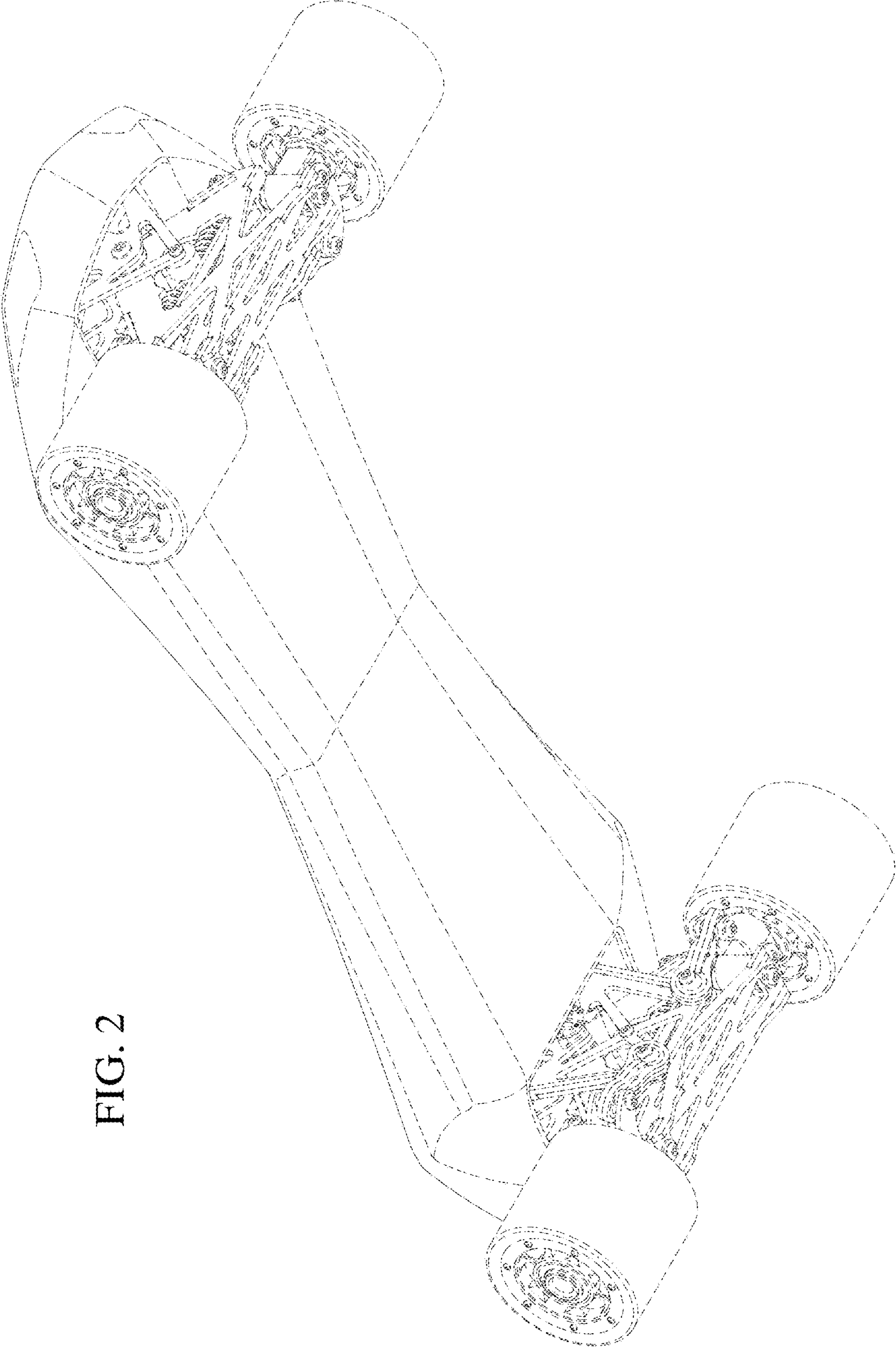

FIG. 2

FIG. 3

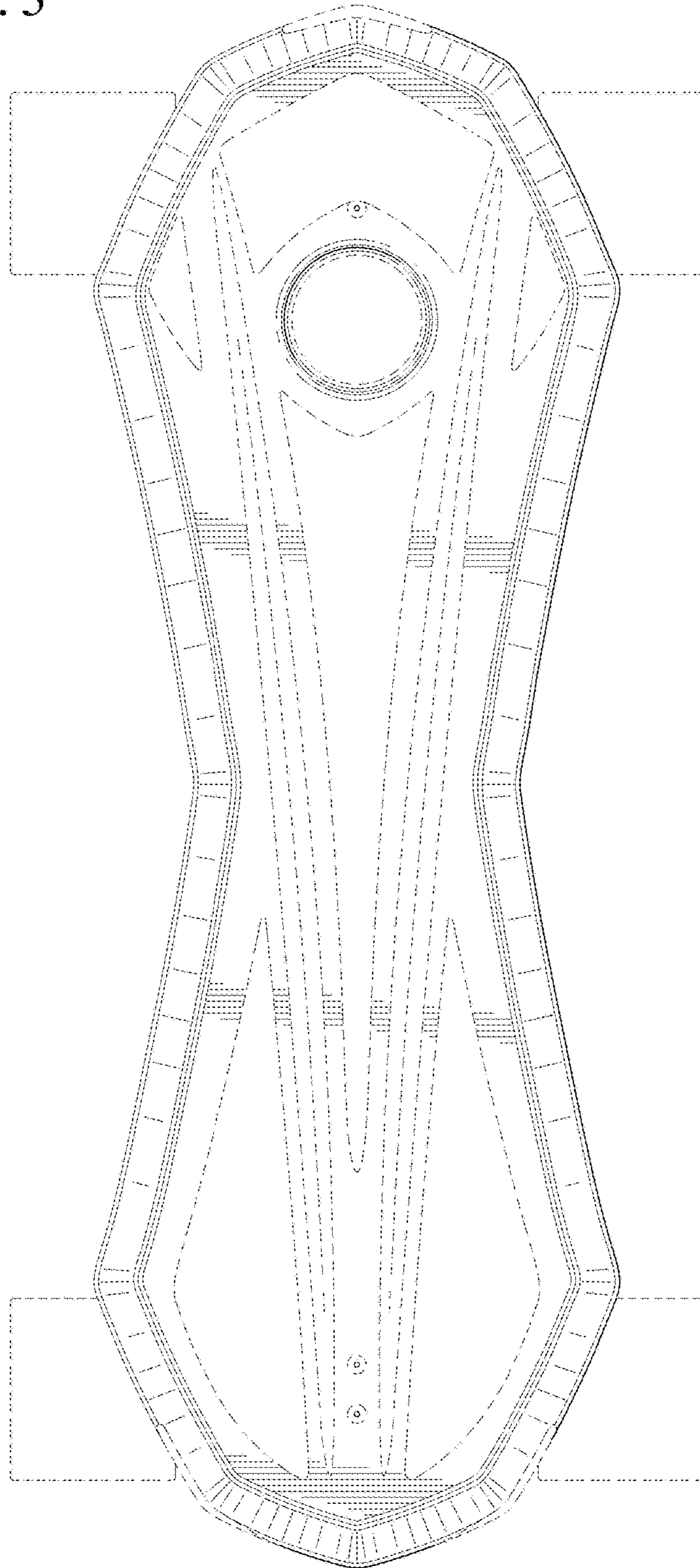

FIG. 4

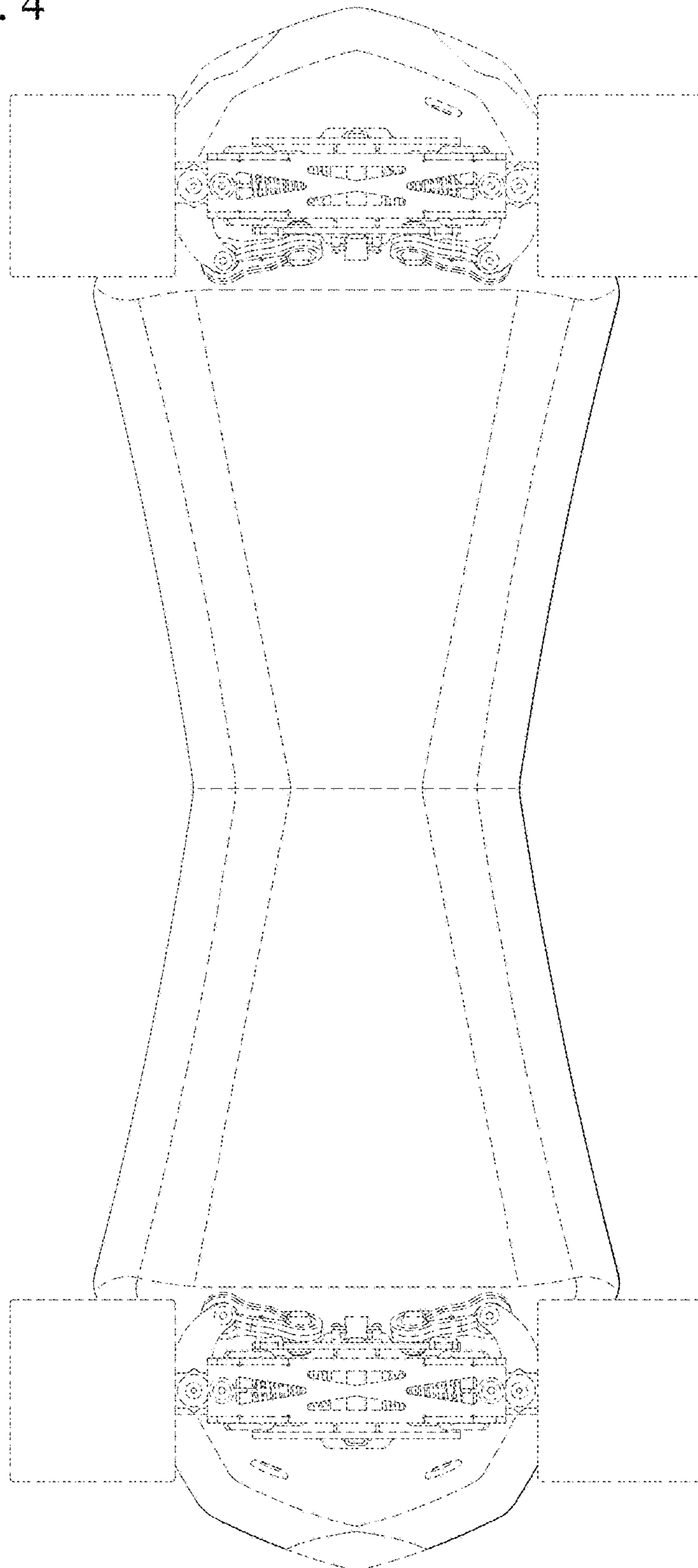

FIG. 5

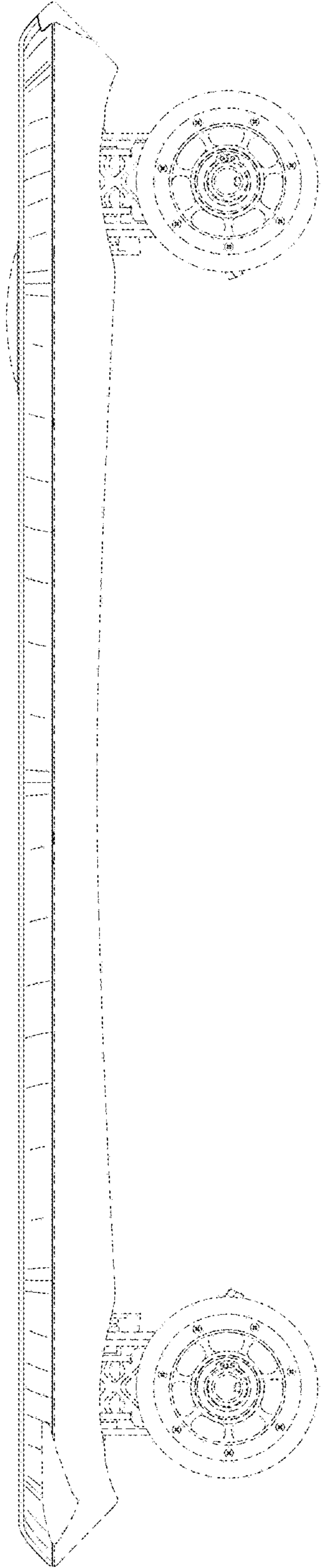

FIG. 6

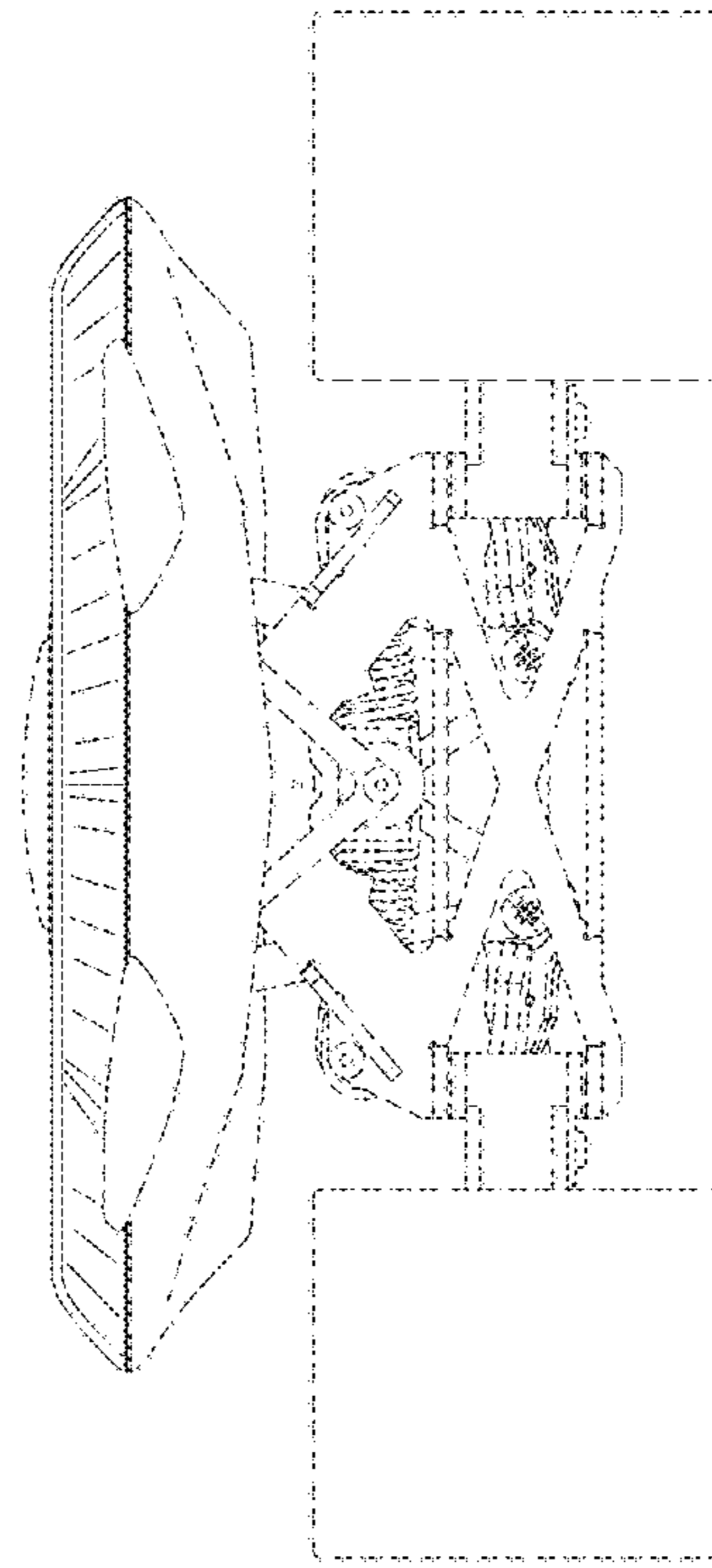

FIG. 7

