

US00D789814S

(12) **United States Design Patent** (10) **Patent No.:** **US D789,814 S**  
**Kodama et al.** (45) **Date of Patent:** **\*\* Jun. 20, 2017**

(54) **CLAMP METER**

FOREIGN PATENT DOCUMENTS

(71) Applicant: **HIOKI E.E. CORPORATION,**  
Nagano (JP)

JP D1302738 6/2007  
JP D1303574 6/2007

(72) Inventors: **Hikaru Kodama,** Ueda (JP); **Tetsuya Yoshiike,** Ueda (JP); **Takeaki Ohsawa,** Ueda (JP); **Seiji Onuma,** Ueda (JP)

*Primary Examiner* — George D. Kirschbaum  
(74) *Attorney, Agent, or Firm* — Greenblum & Bernstein, P.L.C.

(73) Assignee: **HIOKI E.E. CORPORATION,**  
Nagano (JP)

(57) **CLAIM**

The ornamental design for a clamp meter, as shown and described.

(\*\*) Term: **15 Years**

**DESCRIPTION**

(21) Appl. No.: **35/500,771**

(22) Filed: **Sep. 29, 2015**

(80) **Hague Agreement Data**

Int. Filing Date: **Sep. 29, 2015**  
Int. Reg. No.: **DM/088410**  
Int. Reg. Date: **Sep. 29, 2015**  
Int. Reg. Pub. Date: **Apr. 1, 2016**

(30) **Foreign Application Priority Data**

Apr. 7, 2015 (JP) ..... 2015-007875  
Apr. 7, 2015 (JP) ..... 2015-007879

(51) **LOC (10) Cl.** ..... **10-00**

(52) **U.S. Cl.**  
USPC ..... **D10/79**

(58) **Field of Classification Search**  
USPC ..... D10/78, 79  
See application file for complete search history.

(56) **References Cited**

U.S. PATENT DOCUMENTS

D396,657 S 8/1998 Nagai et al.  
D416,820 S 11/1999 Tanaka et al.  
D450,002 S \* 11/2001 Chang ..... D10/79  
D472,829 S \* 4/2003 Chang ..... D10/79

(Continued)

1.-2. Clamp meters  
1.1 : Front  
1.2 : Back  
1.3 : Left  
1.4 : Right  
1.5 : Top  
1.6 : Bottom  
1.7 : Perspective  
1.8 : Perspective view showing the clamp part open  
2.1 : Front  
2.2 : Back  
2.3 : Left  
2.4 : Right  
2.5 : Top  
2.6 : Bottom  
2.7 : Perspective  
2.8 : Perspective view showing the clamp part open  
Designs 1 and 2: each clamp meter measures any electric physical quantities of a measuring object in a state where the measuring objects has been clamped; on the front side of the main body unit, the upper operation unit, the display unit and the lower operation unit are arranged in this order from above; a pair connector capable of connecting measuring cable is disposed on the lower side of the lower operation unit; in addition, on the left side of the main body unit, open and close operation lever is provided for opening and closing the clamp unit.

**1 Claim, 16 Drawing Sheets**

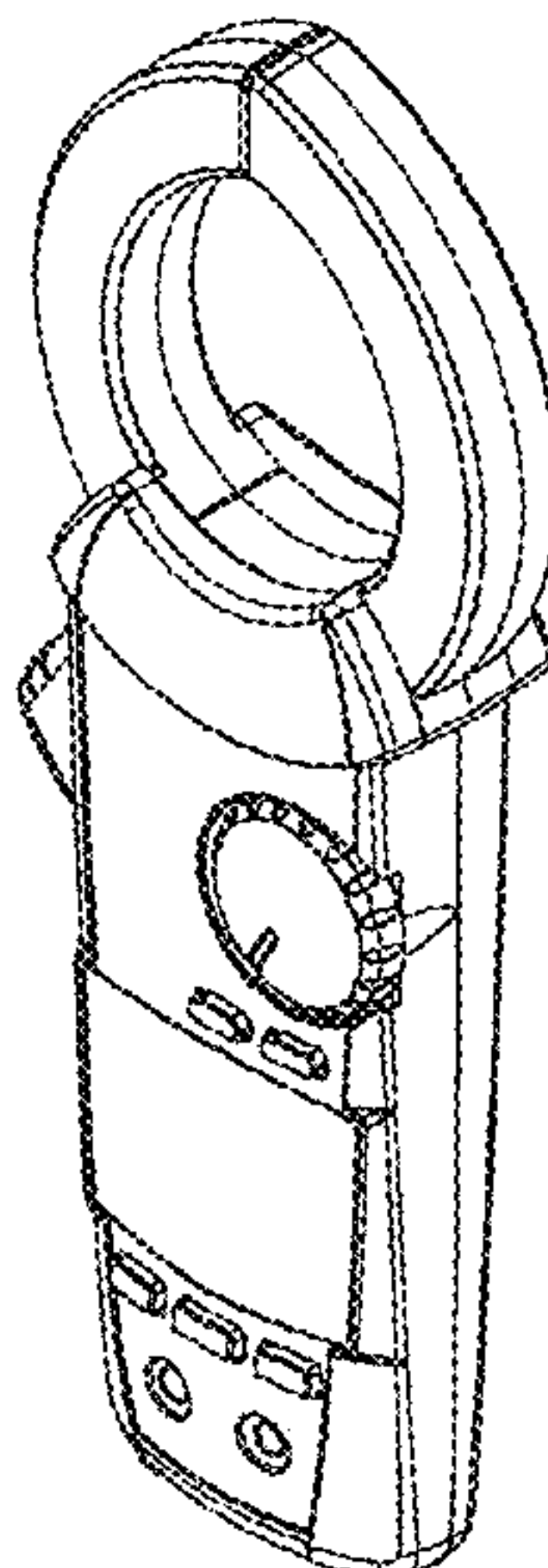

(56)

**References Cited**

U.S. PATENT DOCUMENTS

D472,830 S *	4/2003	Chang .....	D10/79
D514,005 S *	1/2006	Gregorec, Jr. ....	D10/79
D560,130 S	1/2008	Nagai et al.	
D567,687 S *	4/2008	Elrod .....	D10/79
D628,918 S *	12/2010	Chang .....	D10/79
D640,152 S *	6/2011	Laurino .....	D10/79
D683,640 S *	6/2013	Nagai .....	D10/79
D715,169 S *	10/2014	Chen .....	D10/79
D766,118 S *	9/2016	Wong .....	D10/79

\* cited by examiner

1.1

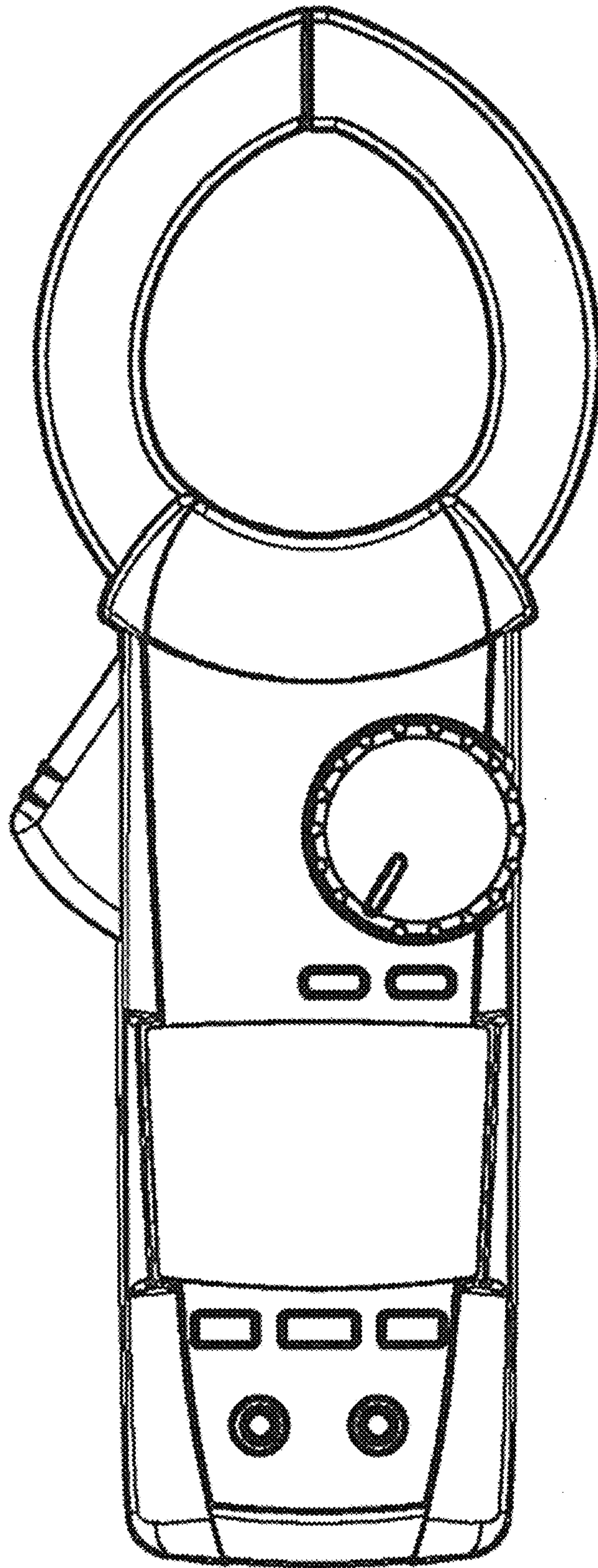



1.2

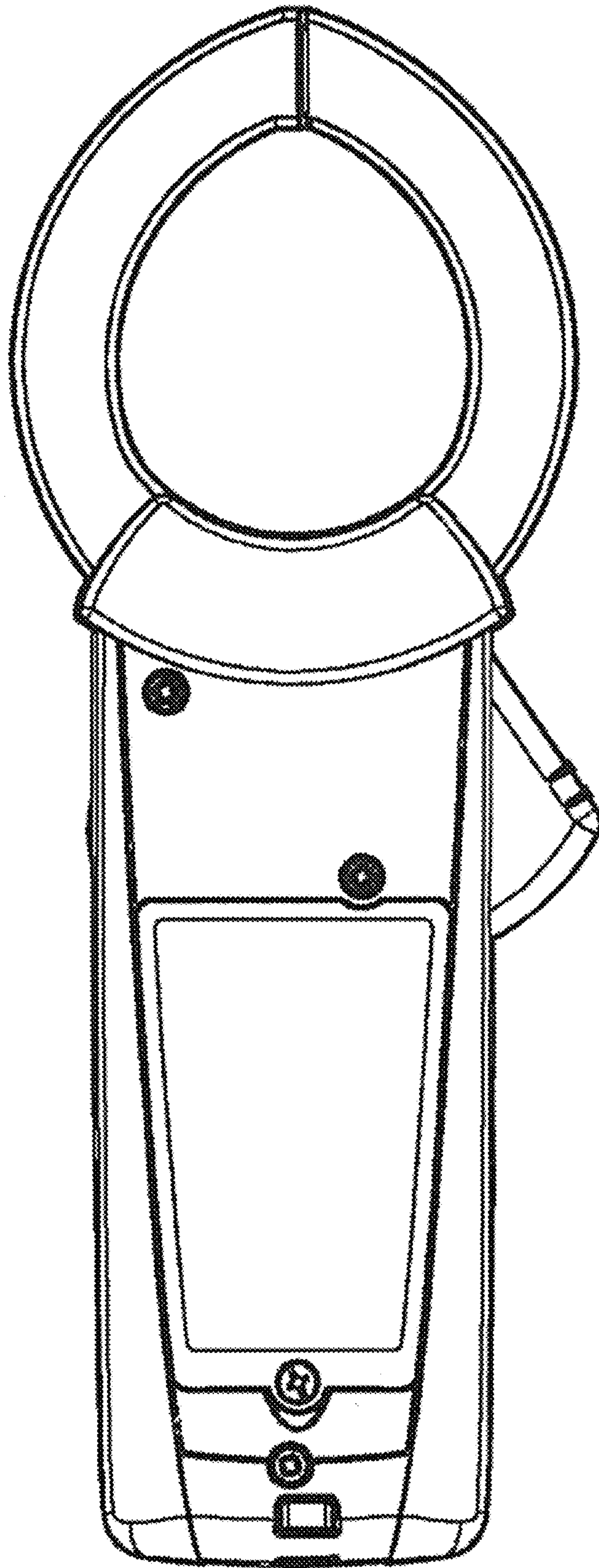

1.3

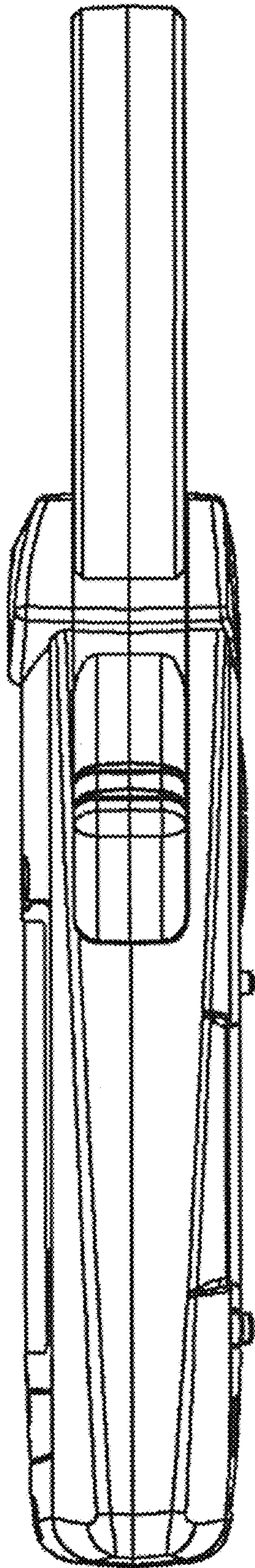

1.4

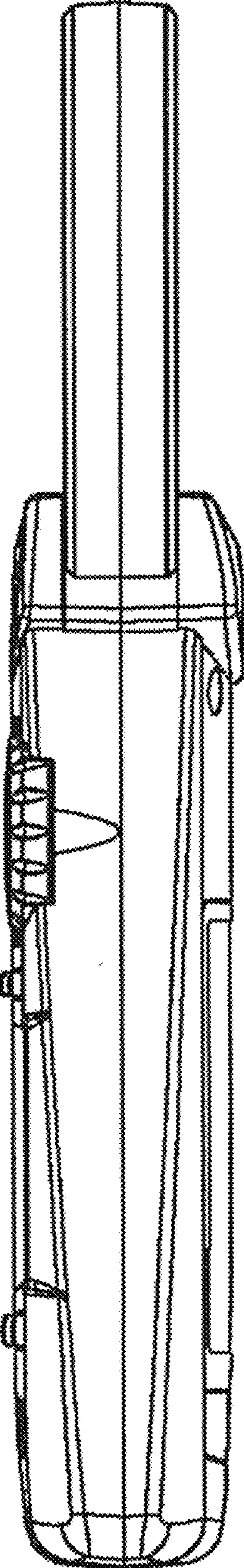

1.5

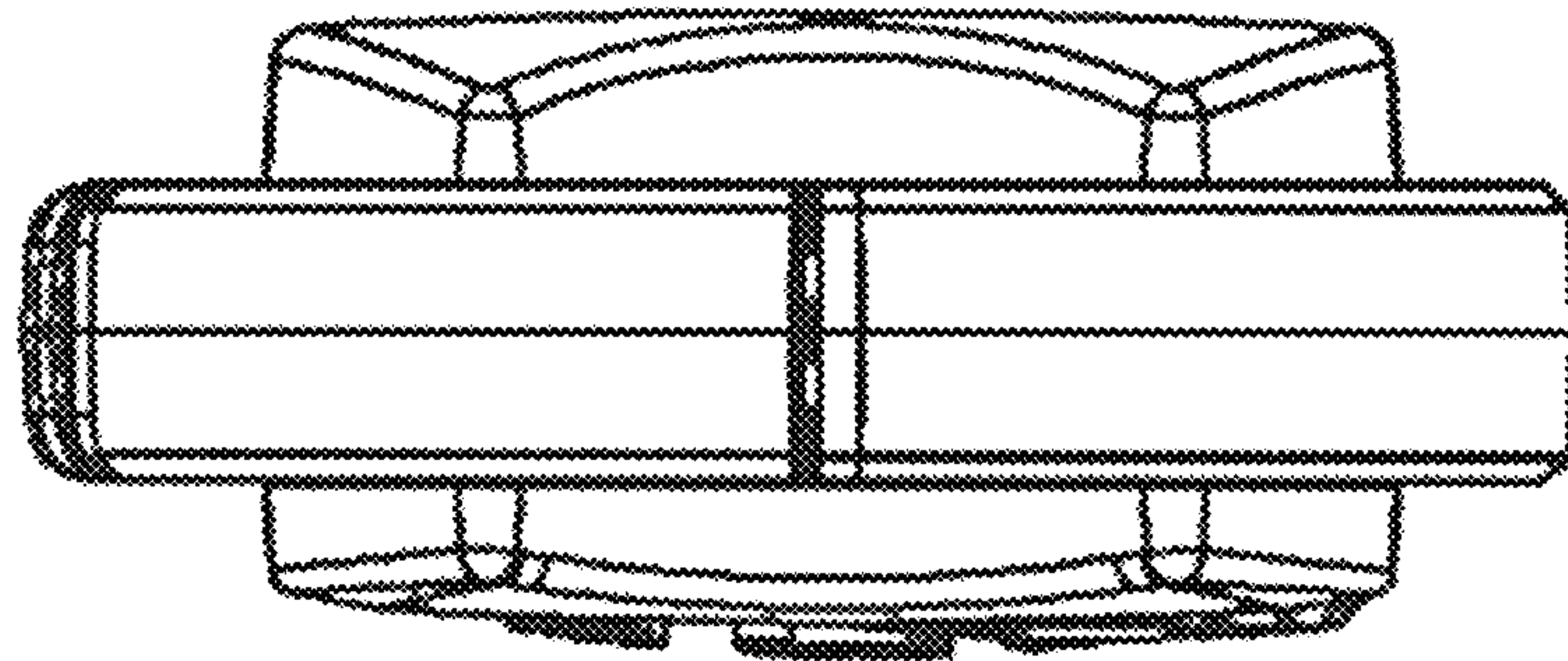



1.6

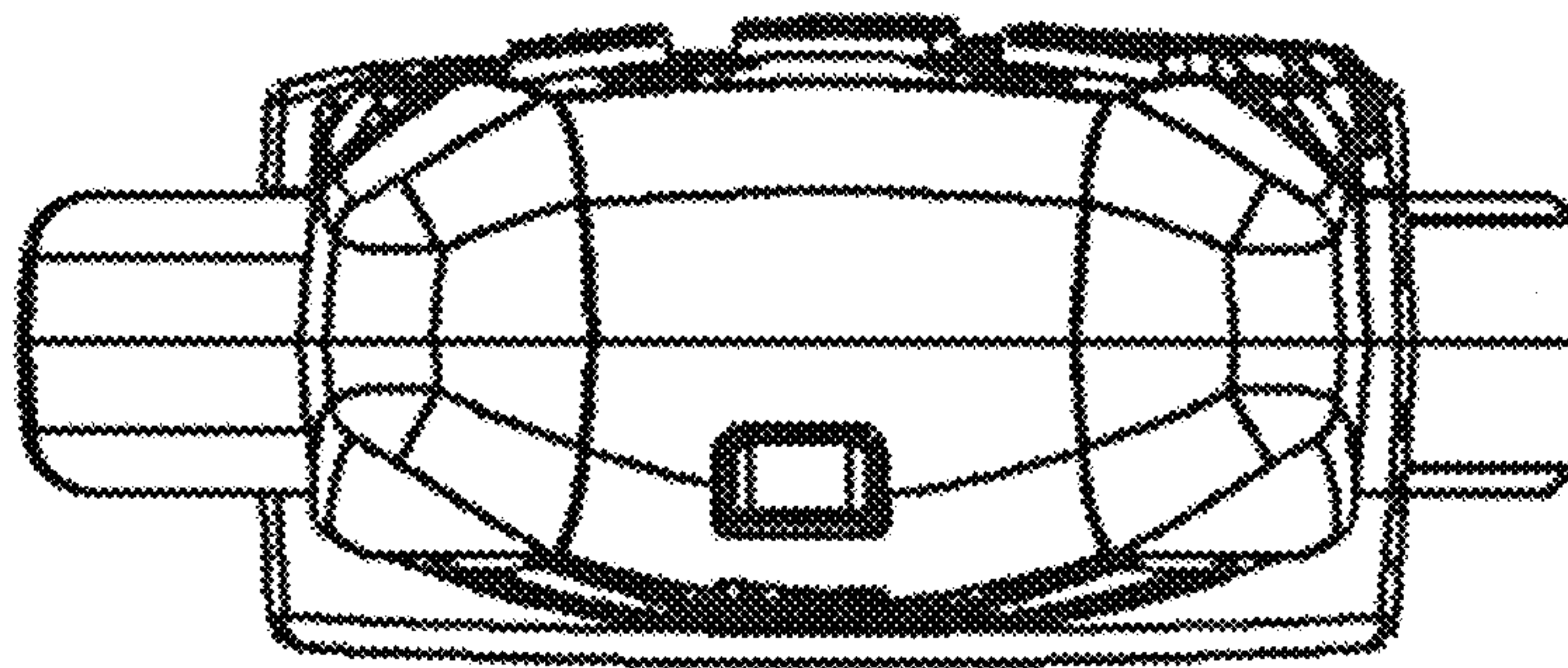



1.7

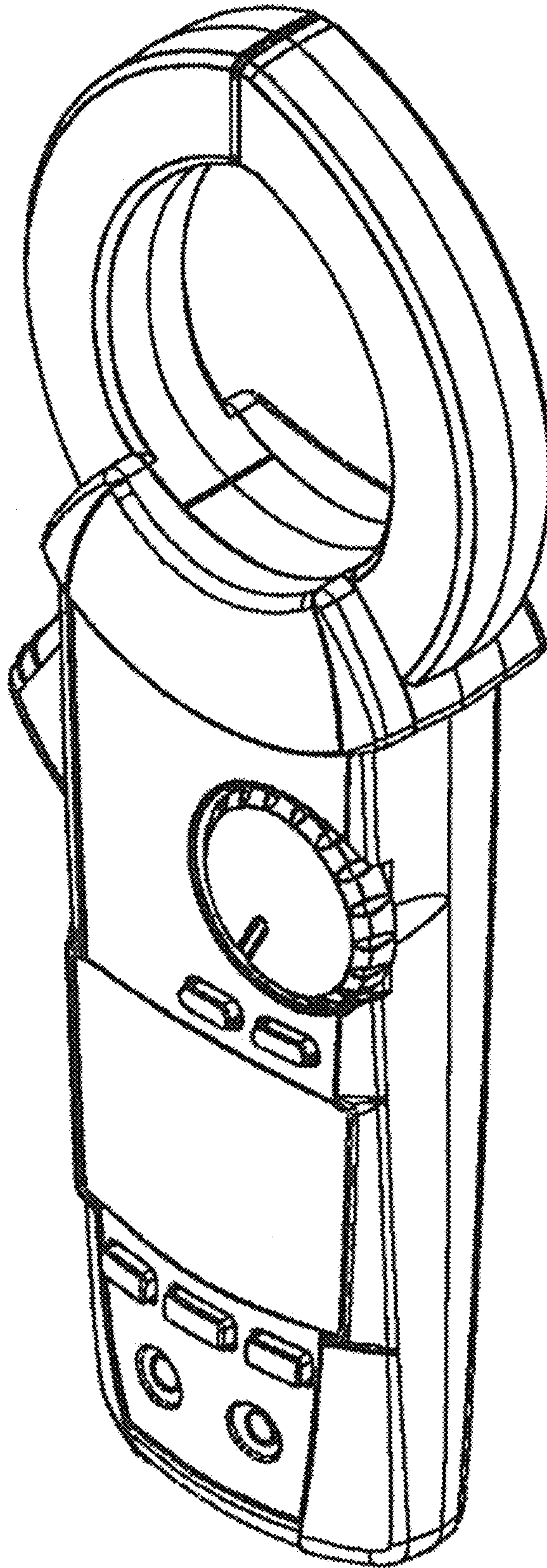

1.8

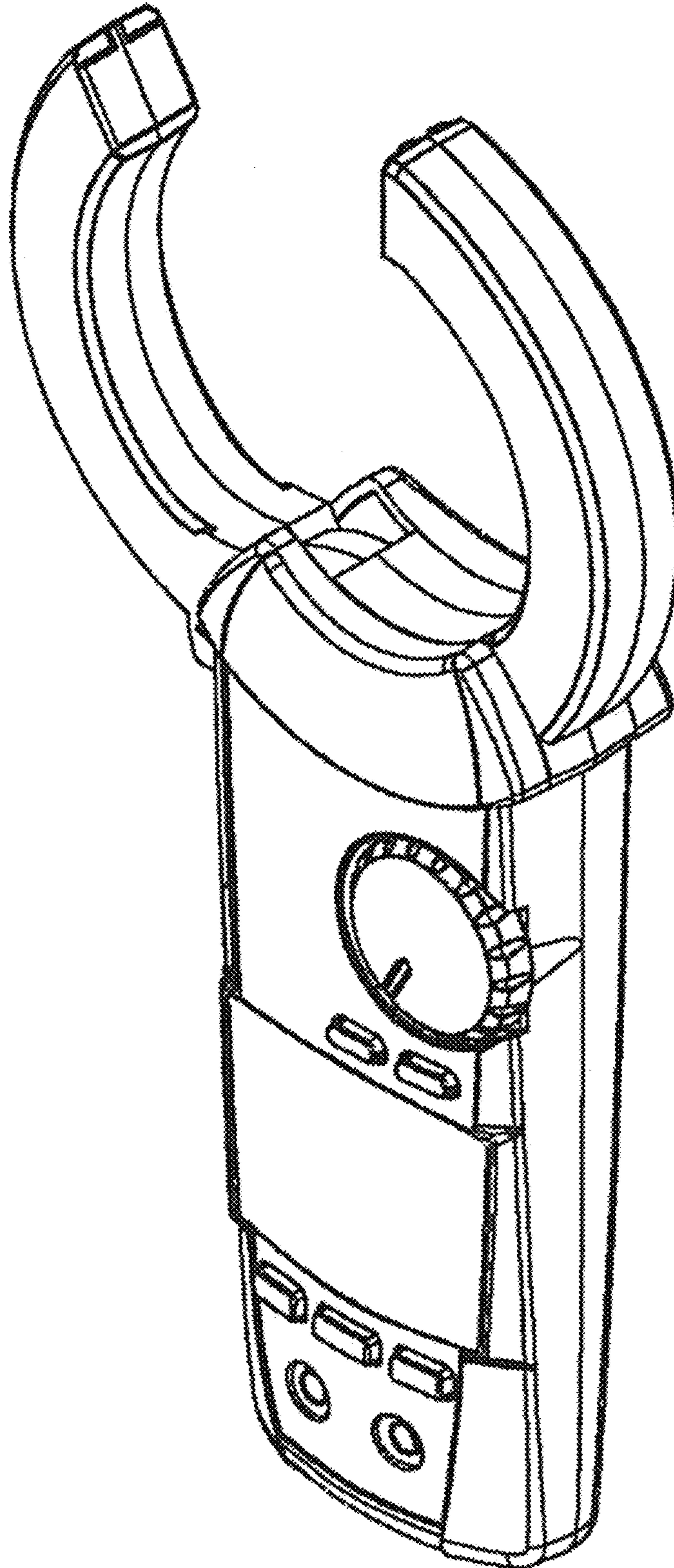



2.1

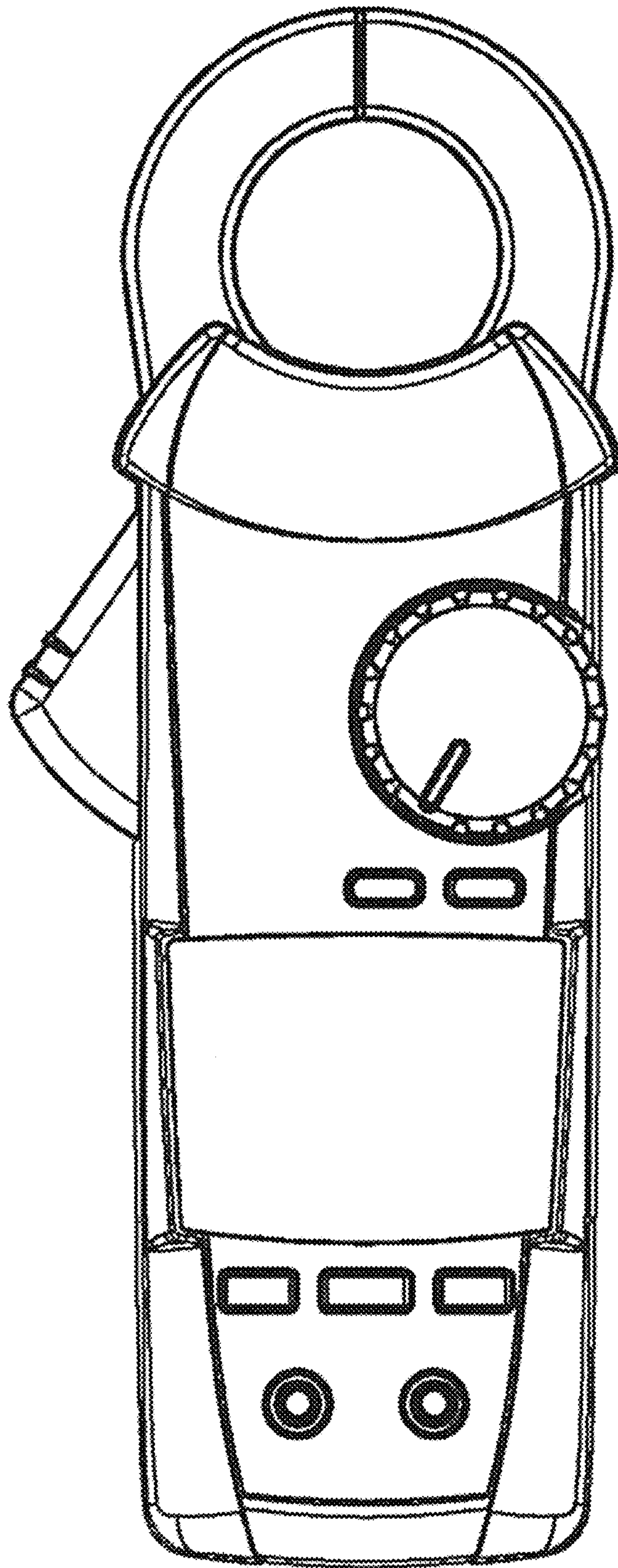

2.2

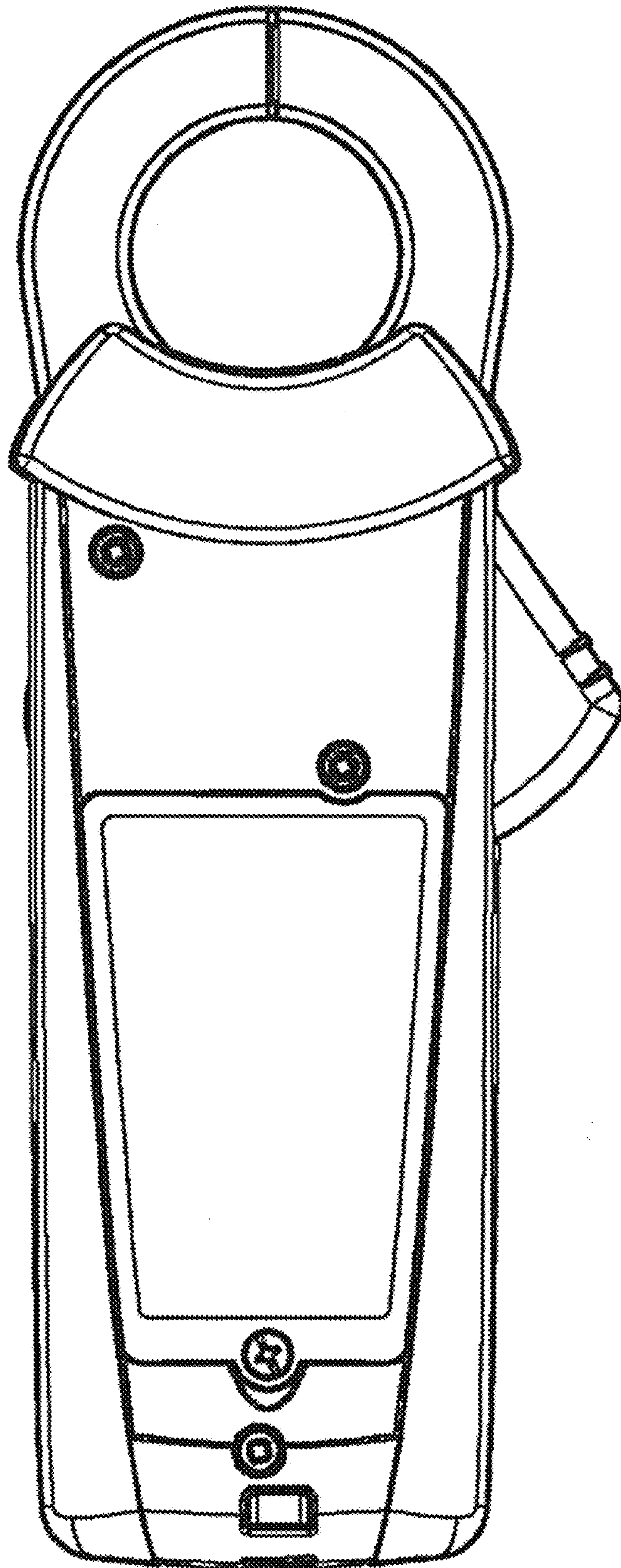



2.3

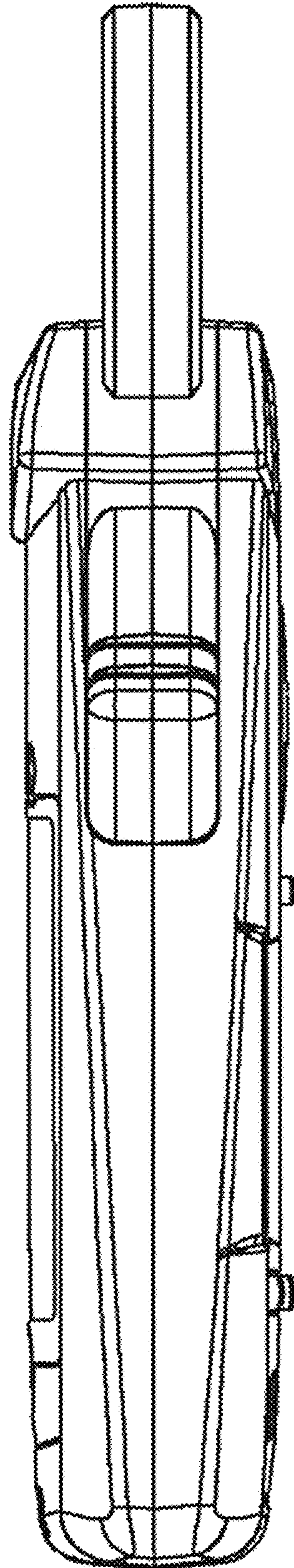

2.4

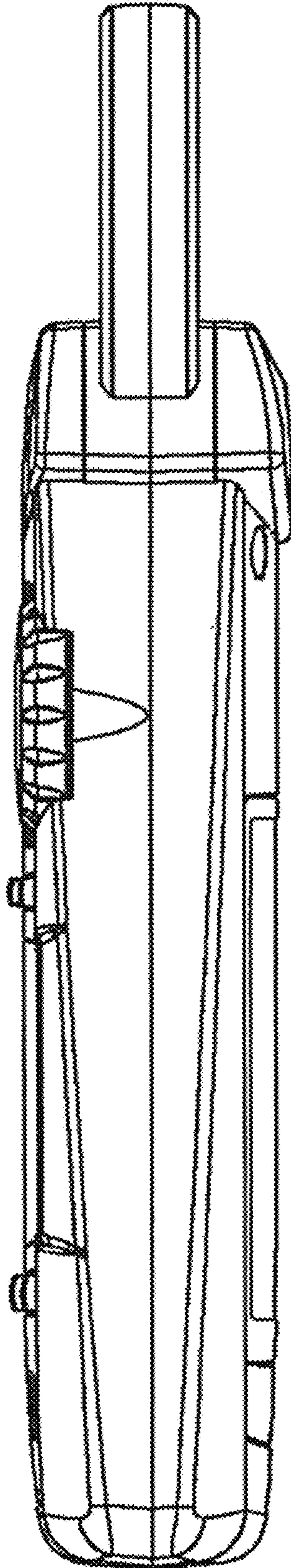

2.5

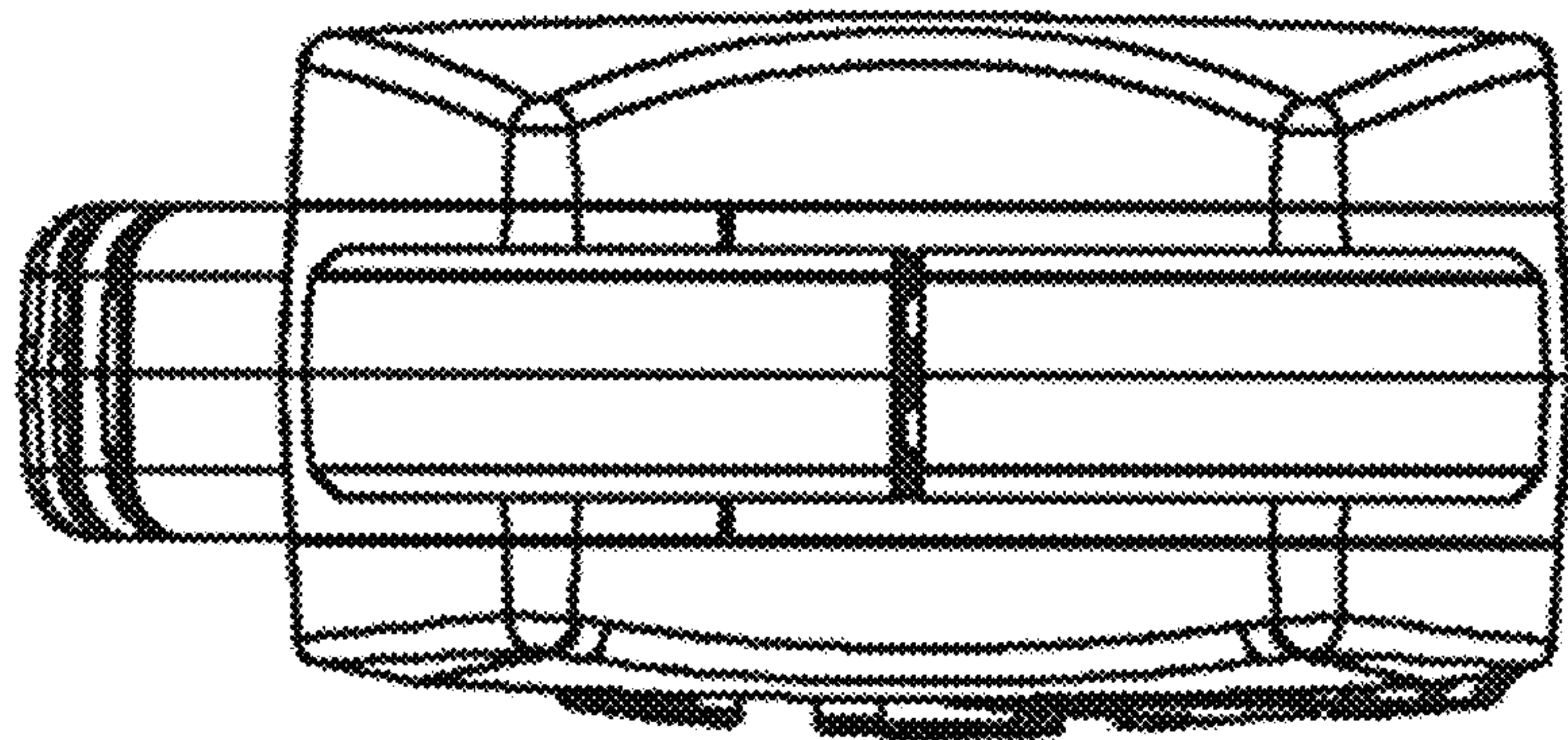

2.6

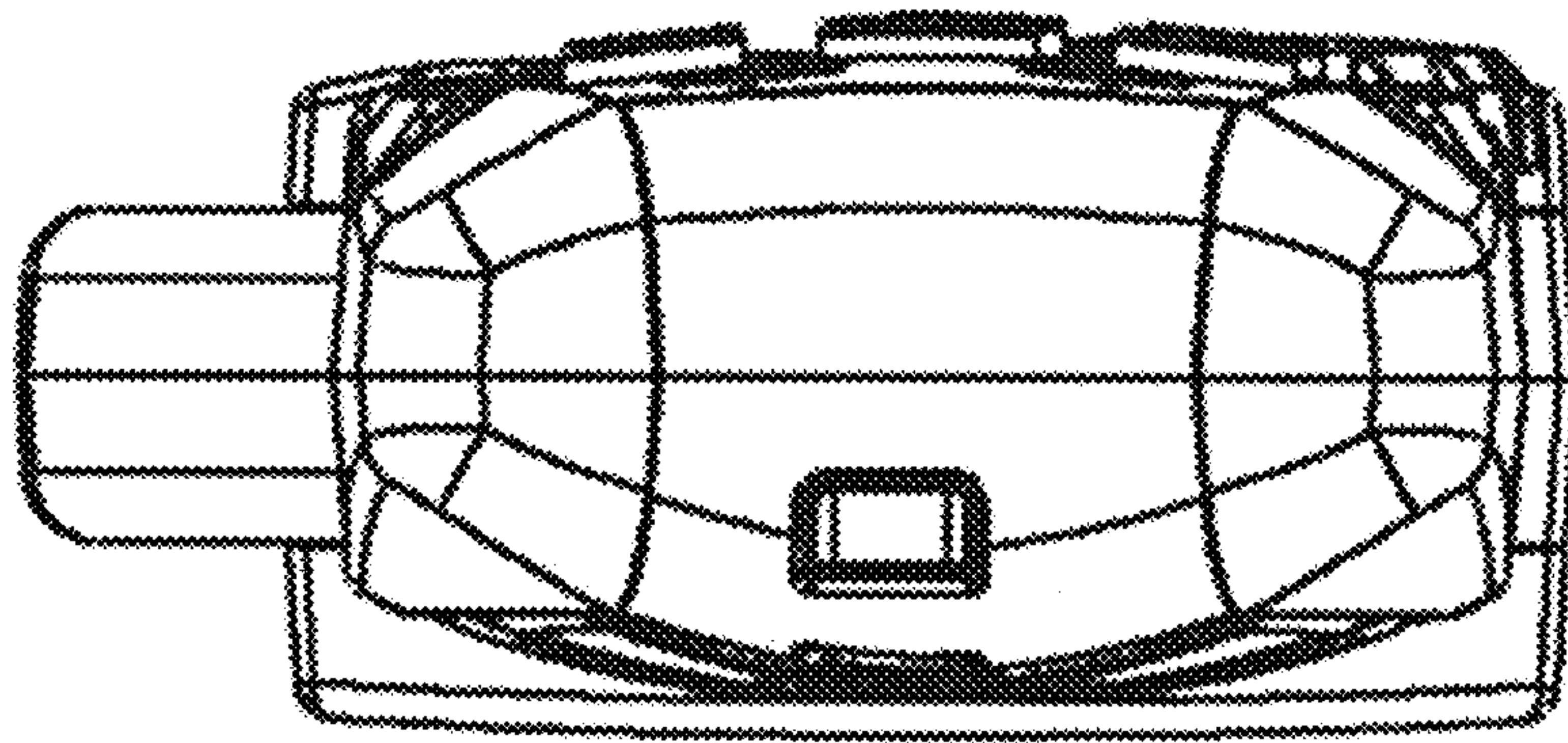



2.7

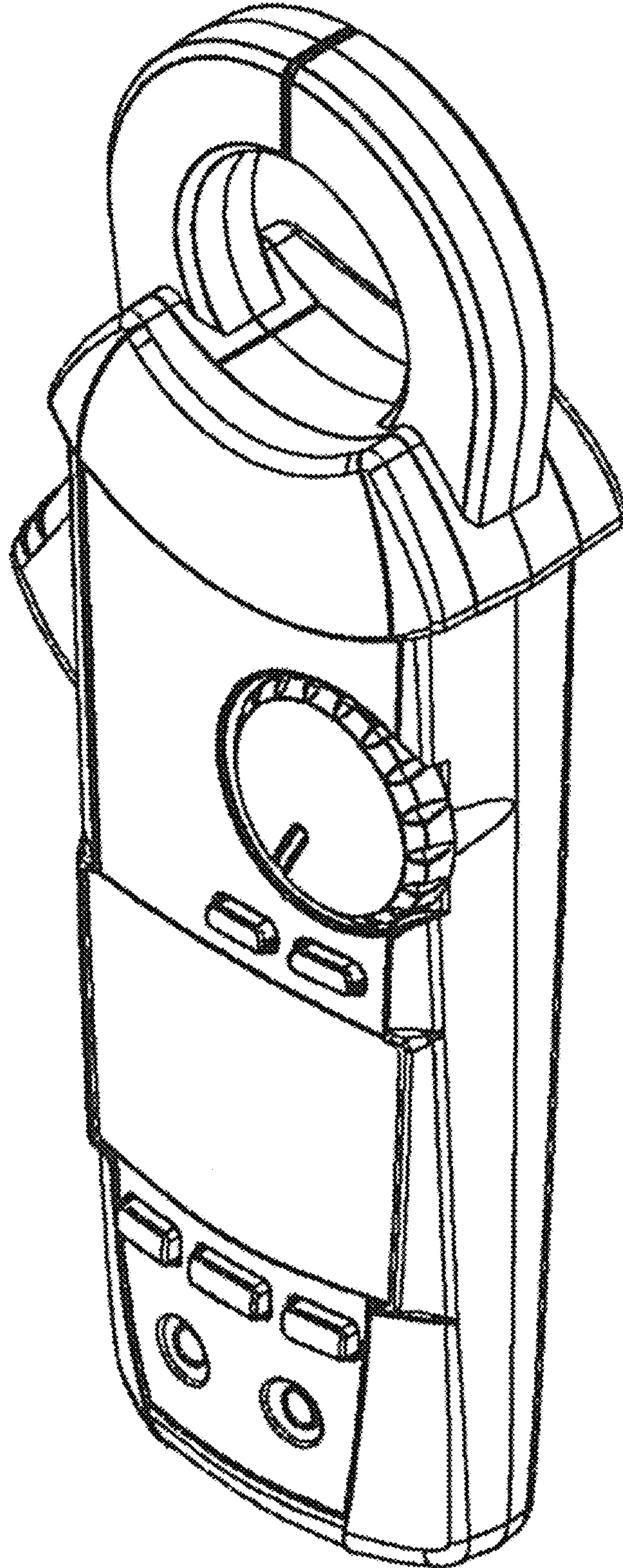

2.8

