



US00D789756S

(12) **United States Design Patent**  
**MacDonald**

(10) **Patent No.:** **US D789,756 S**  
(45) **Date of Patent:** **\*\* Jun. 20, 2017**

(54) **HOLDER FOR WINE BOTTLE AND GLASS**

D774,394 S \* 12/2016 Lloyd ..... D9/455  
2005/0017134 A1 1/2005 Hooper  
2010/0209662 A1 8/2010 Slade

(71) Applicant: **Kenneth MacDonald**, Saugus, MA  
(US)

**FOREIGN PATENT DOCUMENTS**

(72) Inventor: **Kenneth MacDonald**, Saugus, MA  
(US)

EP 1060698 A1 12/2000

(\*\*) Term: **15 Years**

**OTHER PUBLICATIONS**

(21) Appl. No.: **29/547,219**

Etsy. Wine, Wine Bottle, Wine Bottle Toppers, Two Glass Holder, Wood, Engraved, Personalized Engraving by WadeCreations. Dec. 17, 2016 [earliest online date], [site visited Feb. 24, 2017]. Available from Internet, <URL:https://www.etsy.com/listing/47305947/wine-wine-bottle-wine-bottle-toppers-two>.\*

(22) Filed: **Dec. 2, 2015**

Etsy. Oak Wine Bottle and Glass Holder by KRichardWoodworking. Dec. 14, 2016 [earliest online date], [site visited Feb. 24, 2017]. Available from Internet, <URL:https://www.etsy.com/listing/264789069/oak-wine-bottle-and-glass-holder?ref=market>.\*

(51) **LOC (10) Cl.** ..... **07-06**

(52) **U.S. Cl.**  
USPC ..... **D7/701**

Country Barn Woodworking. Wine Bottle Goblet Tree. Dec. 30, 2014 [earliest online date], [site visited Feb. 24, 2017]. Available from Internet, <URL:http://www.countrybarnwoodworking.com/products/wineaccessories/glassholder.htm>.\*

(58) **Field of Classification Search**  
USPC ..... D6/546, 552, 672; D7/701-708, 708.1;  
D9/434, 443, 455; D32/58  
CPC ..... A47G 23/0208; B32B 3/10; A47J 47/16;  
A47J 47/20

See application file for complete search history.

\* cited by examiner

(56) **References Cited**

*Primary Examiner* — Robert M Spear  
*Assistant Examiner* — Darcey E Heflin

**U.S. PATENT DOCUMENTS**

(57) **CLAIM**

- D159,141 S \* 6/1950 Conrad ..... 294/170
- D198,196 S \* 5/1964 Buchanan ..... D8/DIG. 1
- D260,472 S \* 9/1981 Turcotte, Jr. .... D7/708
- D364,806 S \* 12/1995 Cole ..... D9/434
- D380,670 S \* 7/1997 Blocker ..... D9/434
- D399,422 S \* 10/1998 Marley ..... D3/315
- D410,386 S \* 6/1999 Watkins ..... D9/434
- D423,349 S \* 4/2000 Lyons ..... D9/434
- D452,435 S \* 12/2001 Lichter ..... D9/434
- D463,279 S \* 9/2002 Piazza ..... D9/434
- 6,615,996 B1 9/2003 Ivey
- D486,642 S 2/2004 Tagliati
- D575,600 S \* 8/2008 Mayer ..... D7/553.1
- D614,926 S \* 5/2010 Cox ..... D7/708
- 7,984,813 B1 7/2011 Tapager
- 8,567,617 B1 10/2013 Tapager

I claim the ornamental design for a holder for wine bottle and glass, as shown and described.

**DESCRIPTION**

FIG. 1 is a top view of the holder for wine bottle and glass.  
FIG. 2 is a front view of the claimed design.  
FIG. 3 is a back view of the claimed design.  
FIG. 4 is a right view of the claimed design.  
FIG. 5 is a left view of the claimed design; and,  
FIG. 6 is a perspective view of the claimed design.

**1 Claim, 4 Drawing Sheets**

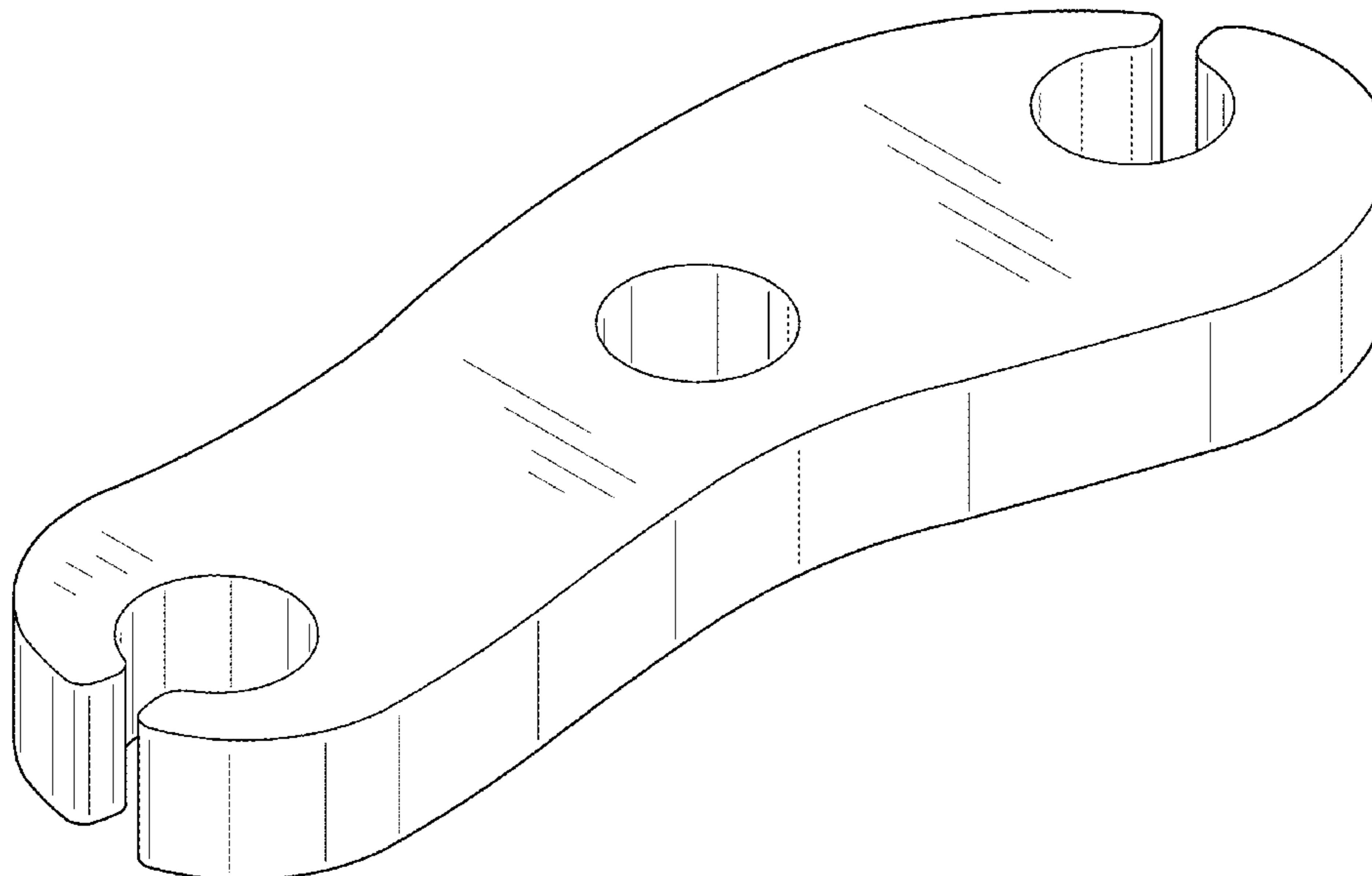

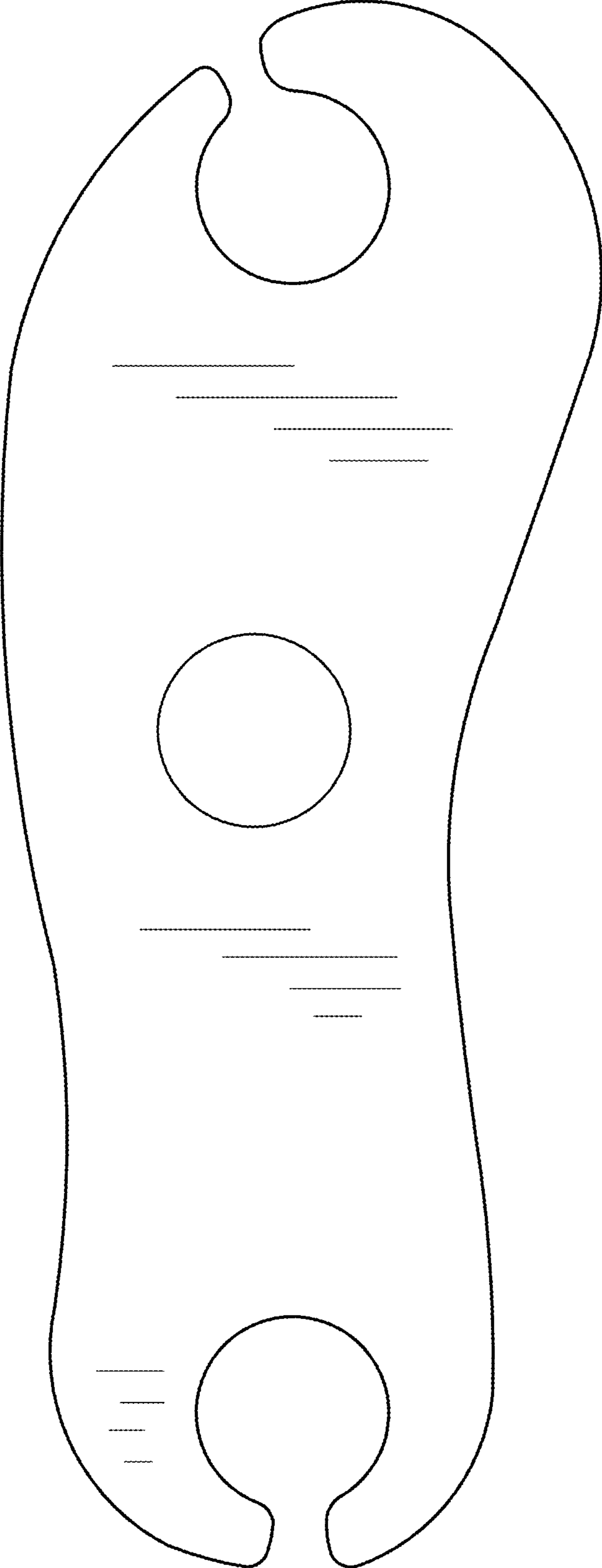

FIG. 1

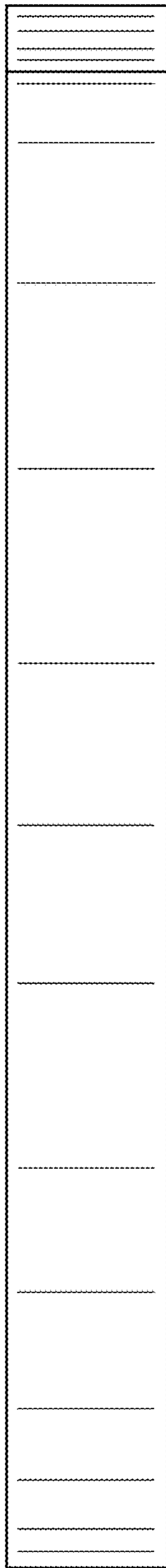

FIG. 2

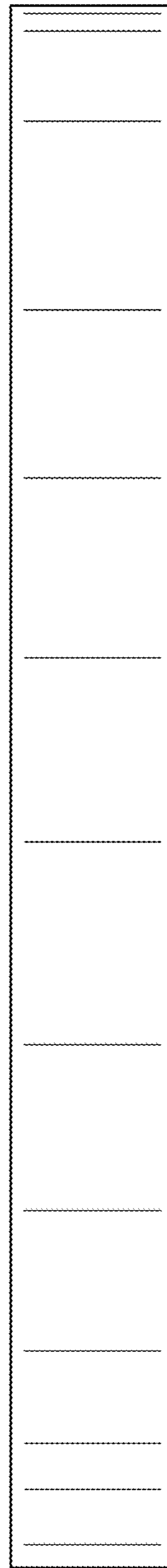

FIG. 3

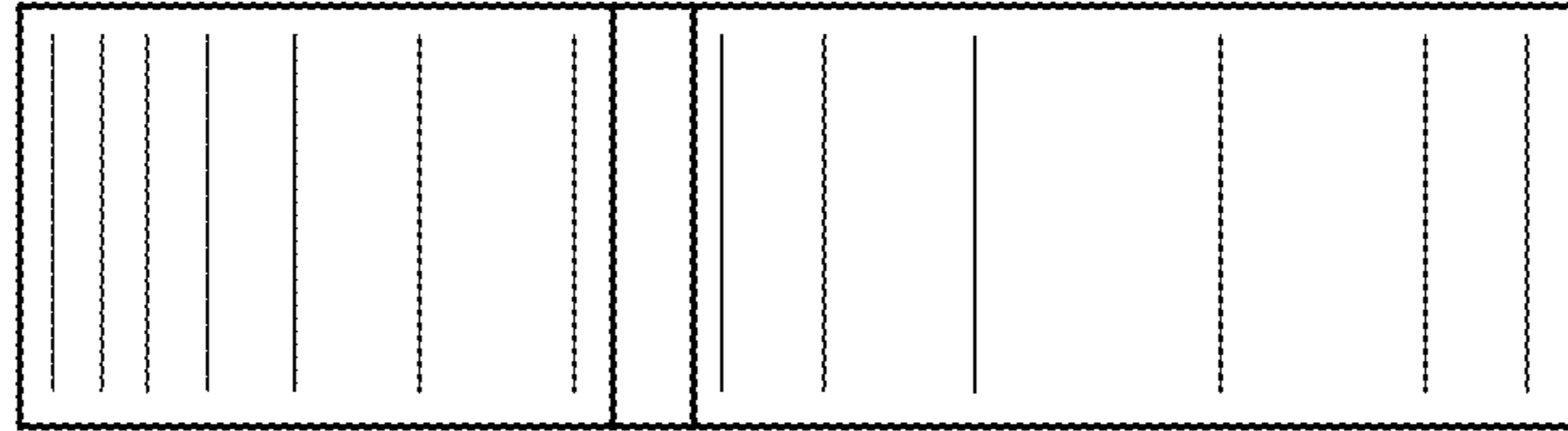

FIG. 4

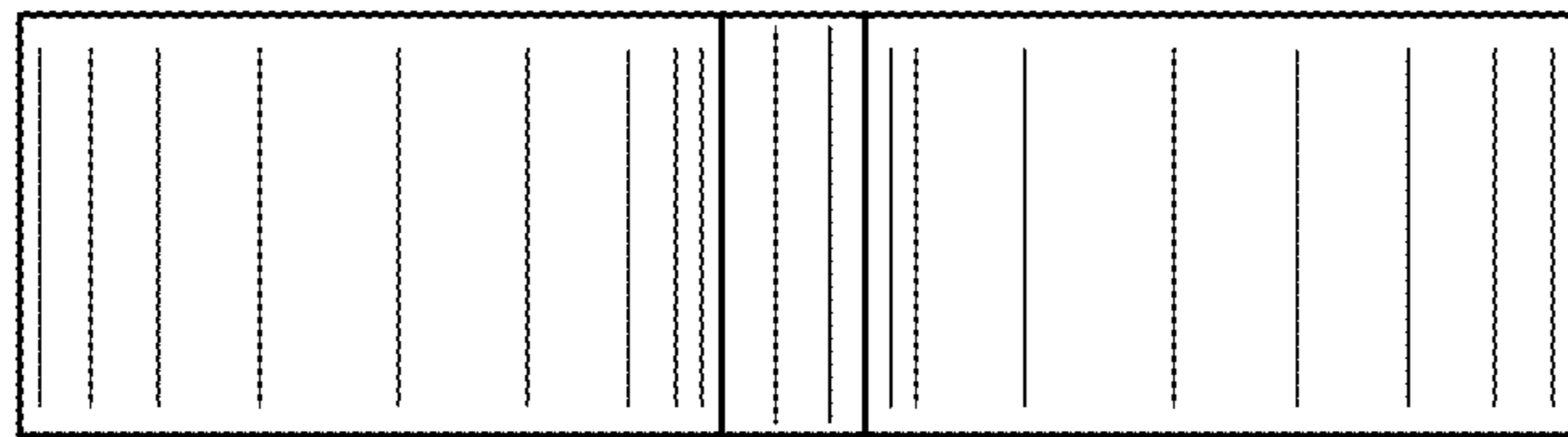

FIG. 5

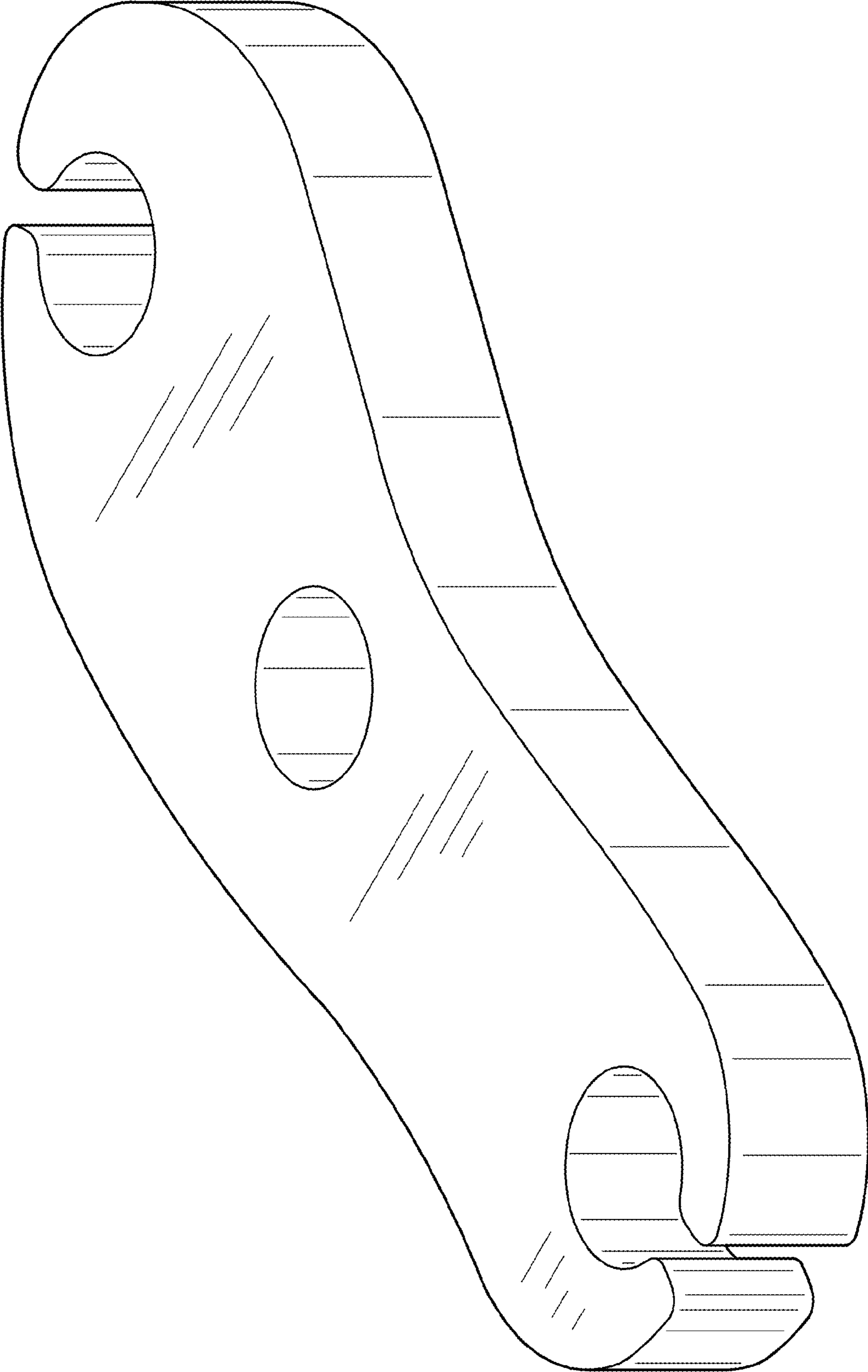

FIG. 6