



US00D789642S

(12) **United States Design Patent** (10) **Patent No.:** **US D789,642 S**
McMurtrey et al. (45) **Date of Patent:** **** Jun. 13, 2017**

(54) **SHOPPING CART BUMPER**

2008/0149649 A1* 6/2008 Knupfer B62B 5/0006
220/694

(71) Applicant: **Unarco Industries LLC**, Wagoner, OK (US)

* cited by examiner

(72) Inventors: **Wesley McMurtrey**, Bixby, OK (US);
Charlie Wagner, Coweta, OK (US)

Primary Examiner — Cynthia Ramirez

(74) *Attorney, Agent, or Firm* — Banner & Witcoff, Ltd.

(73) Assignee: **Unarco Industries, LLC**, Wagoner, OK (US)

(57) **CLAIM**

The ornamental design for a shopping cart bumper, as shown and described.

(**) Term: **15 Years**

DESCRIPTION

(21) Appl. No.: **29/547,625**

FIG. 1 is a front perspective view of a first embodiment of a shopping cart bumper showing our new design;

(22) Filed: **Dec. 4, 2015**

FIG. 2 is a rear perspective view thereof;

(51) **LOC (10) Cl.** **12-02**

FIG. 3 is a front view thereof;

(52) **U.S. Cl.**

FIG. 4 is a left side view thereof;

USPC **D34/27**

FIG. 5 is a rear view thereof;

(58) **Field of Classification Search**

USPC D34/27; 280/33.991, 33.992, 33.993;
224/273, 277

FIG. 6 is a right side view thereof;

CPC ... B62B 5/0006; B62B 3/1428; B62B 3/1444;
B62B 3/1416

FIG. 7 is a top view thereof;

See application file for complete search history.

FIG. 8 is a bottom view thereof;

(56) **References Cited**

U.S. PATENT DOCUMENTS

- 4,883,281 A * 11/1989 Waterman B62B 5/0006
248/345.1
- D333,900 S * 3/1993 Kinnamon D12/168
- D483,541 S * 12/2003 Liu D34/27
- D525,008 S * 7/2006 Hubbard D34/27
- D636,963 S * 4/2011 Walter D34/27
- D672,522 S * 12/2012 Taylor D34/27
- D707,009 S * 6/2014 Walter D34/27
- D728,889 S * 5/2015 Morin D34/27
- D732,260 S * 6/2015 Wiley D34/27
- D743,663 S * 11/2015 Hoffheimer D34/27

FIG. 9 is an alternate perspective view of FIG. 1 shown in an exemplary environment thereof;

FIG. 10 is a front perspective view of a second embodiment of a shopping cart bumper showing our new design;

FIG. 11 is a rear perspective view thereof;

FIG. 12 is a front view thereof;

FIG. 13 is a right side view thereof;

FIG. 14 is a rear view thereof;

FIG. 15 is a left side view thereof;

FIG. 16 is a top view thereof;

FIG. 17 is a bottom view thereof; and,

FIG. 18 is an alternate perspective view of FIG. 10 shown in an exemplary environment thereof.

The broken lines immediately adjacent to the shaded area represent unclaimed boundaries of the design. The broken lines showing the remainder of the shopping cart bumper are for environmental purposes only and form no part of the claimed design.

1 Claim, 10 Drawing Sheets

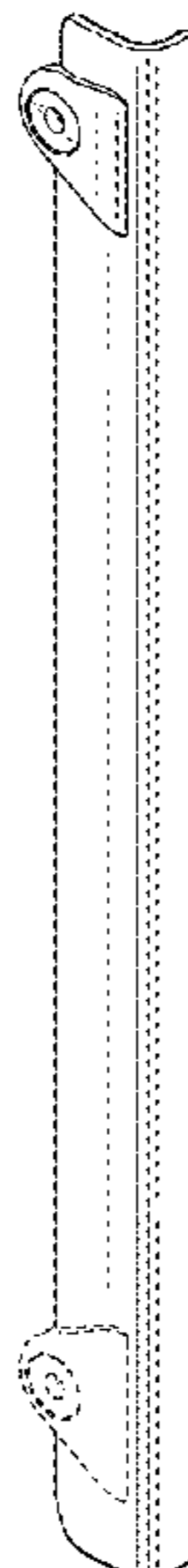

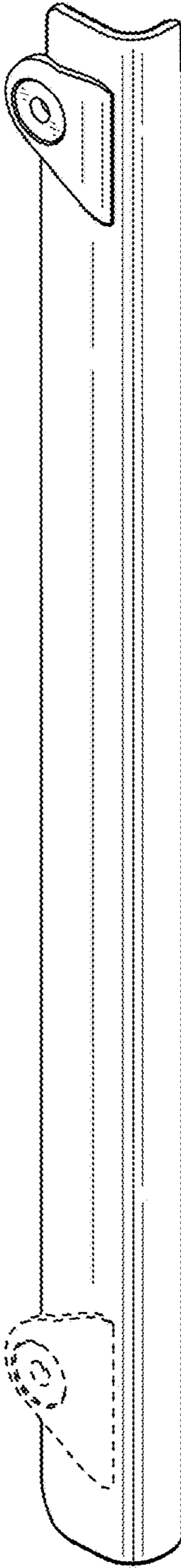

FIG. 1

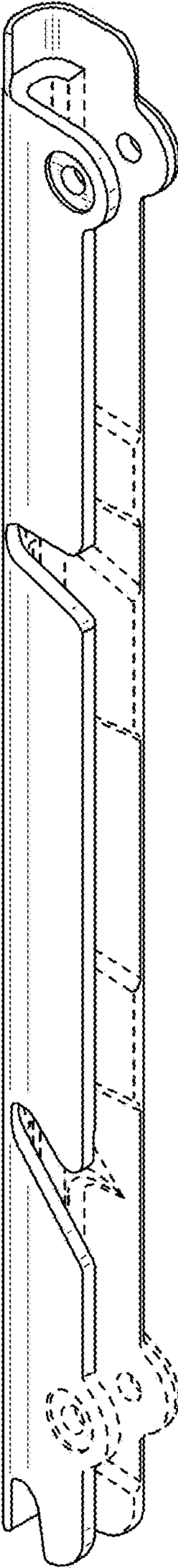

FIG. 2



FIG. 3

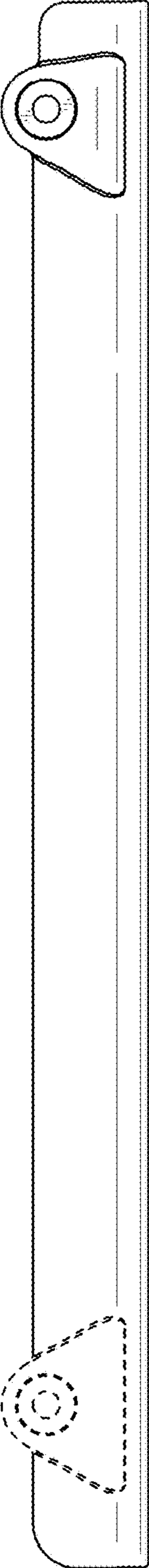

FIG. 4

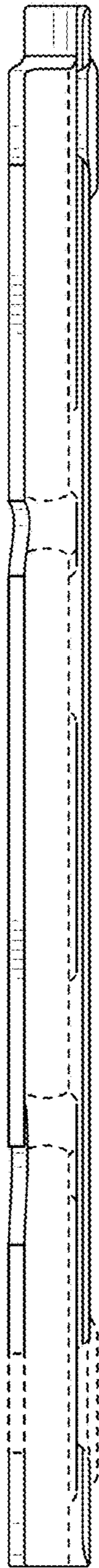

FIG. 5

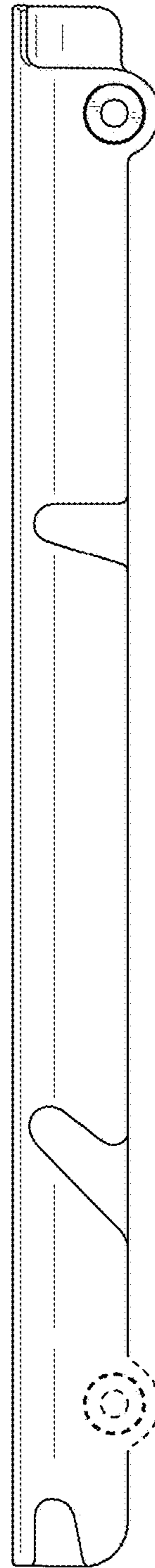

FIG. 6

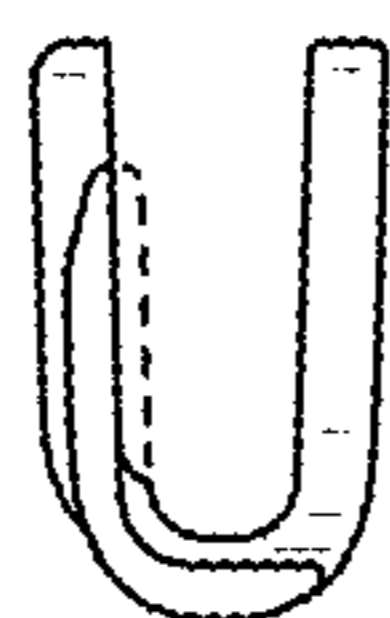

FIG. 7

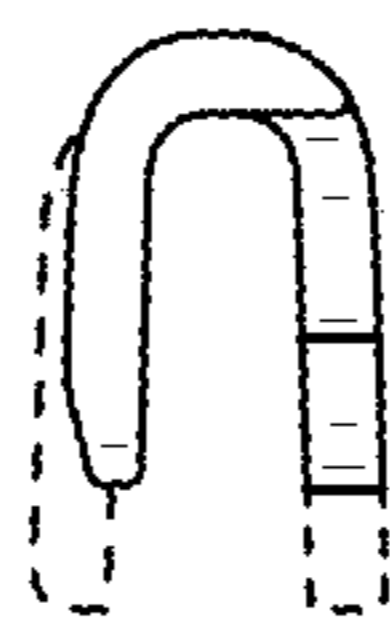

FIG. 8

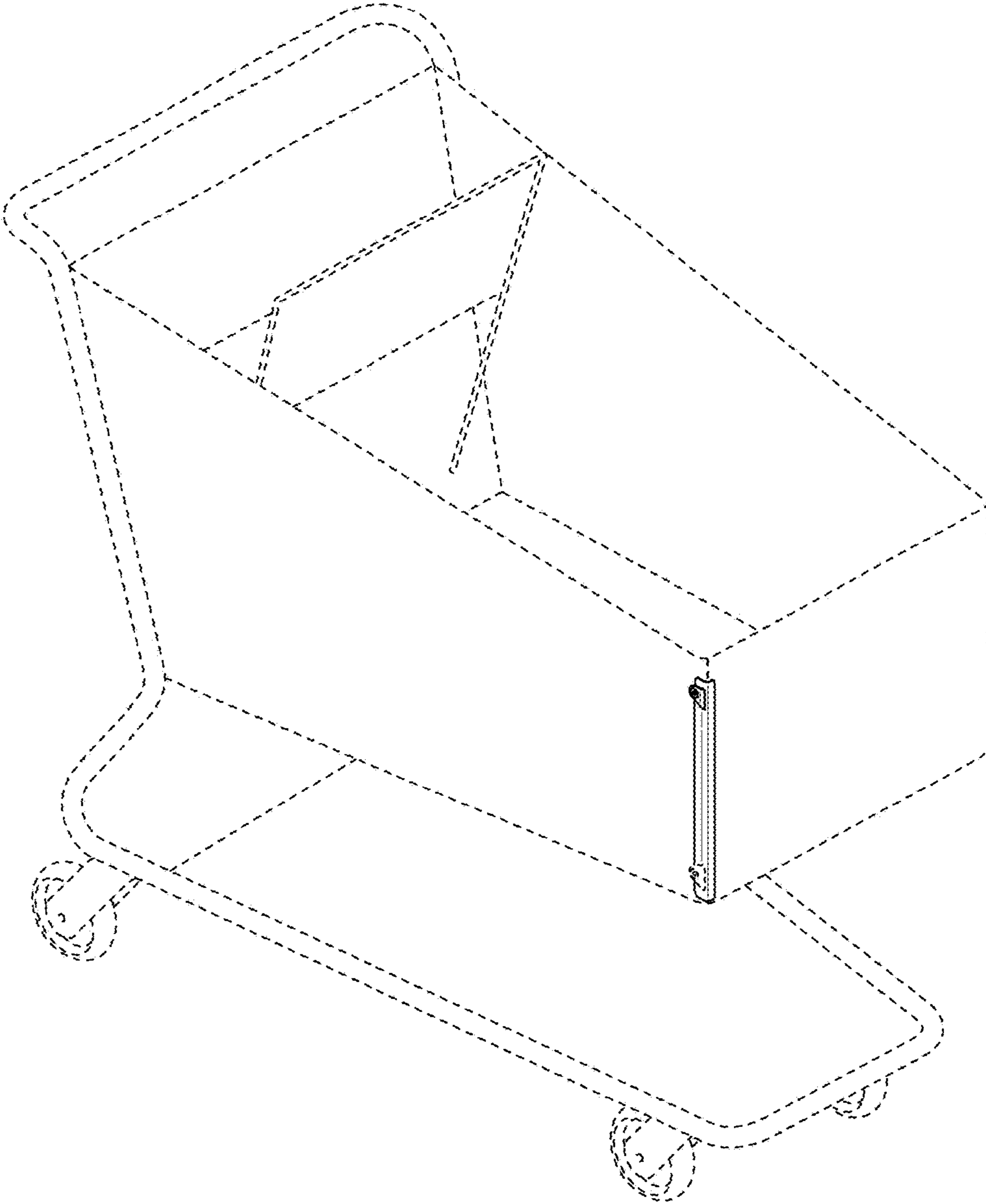

FIG. 9

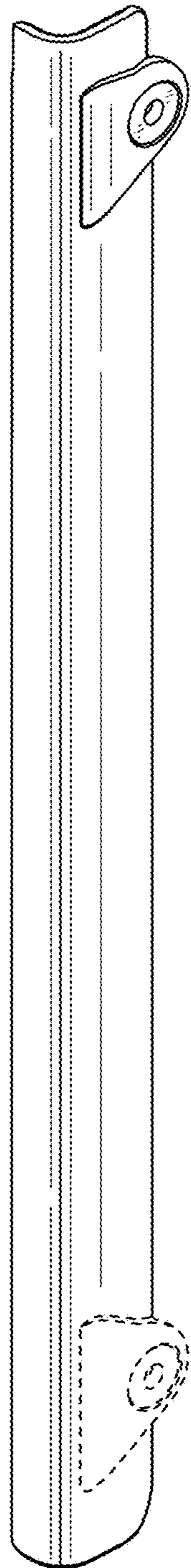

FIG. 10

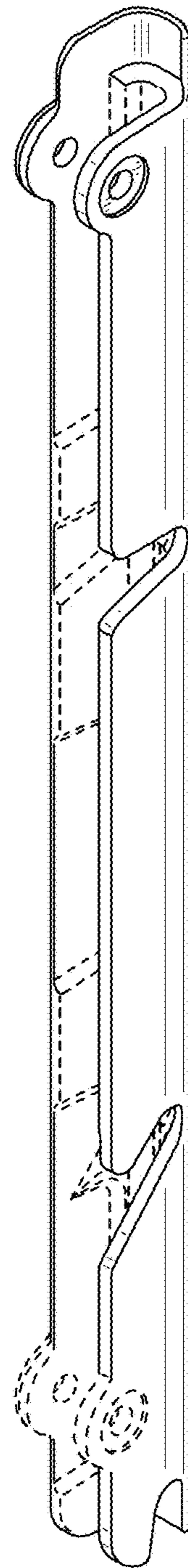

FIG. 11

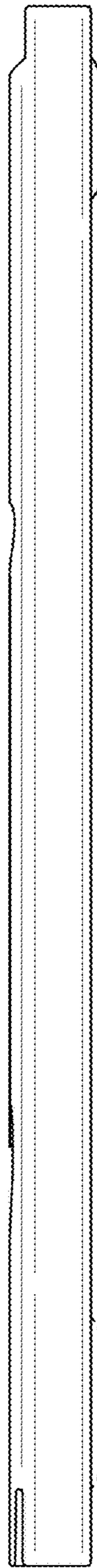

FIG. 12

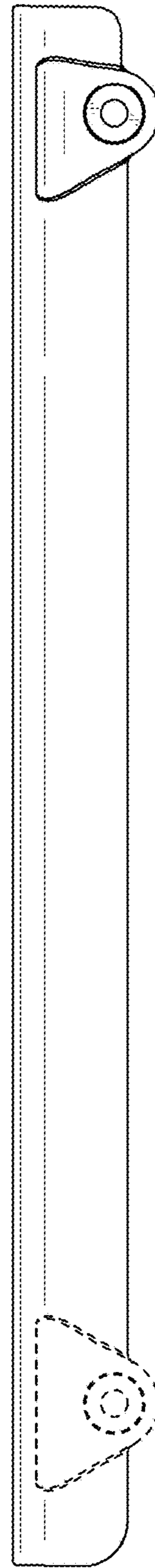

FIG. 13

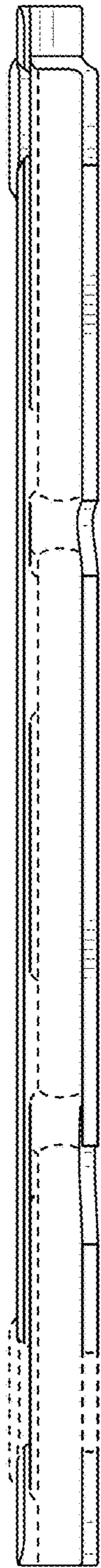

FIG. 14

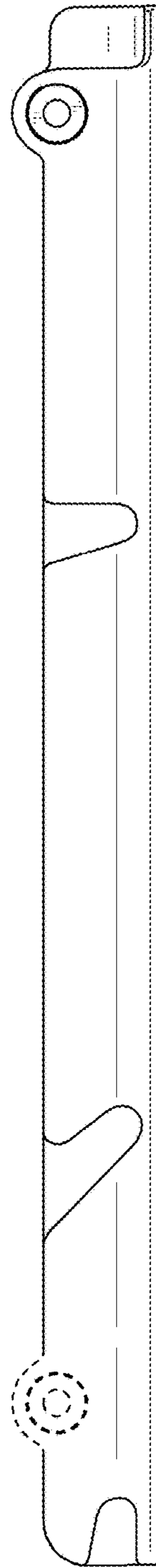

FIG. 15



FIG. 16

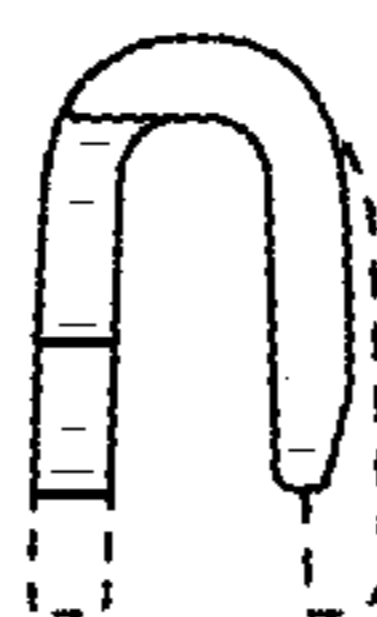

FIG. 17

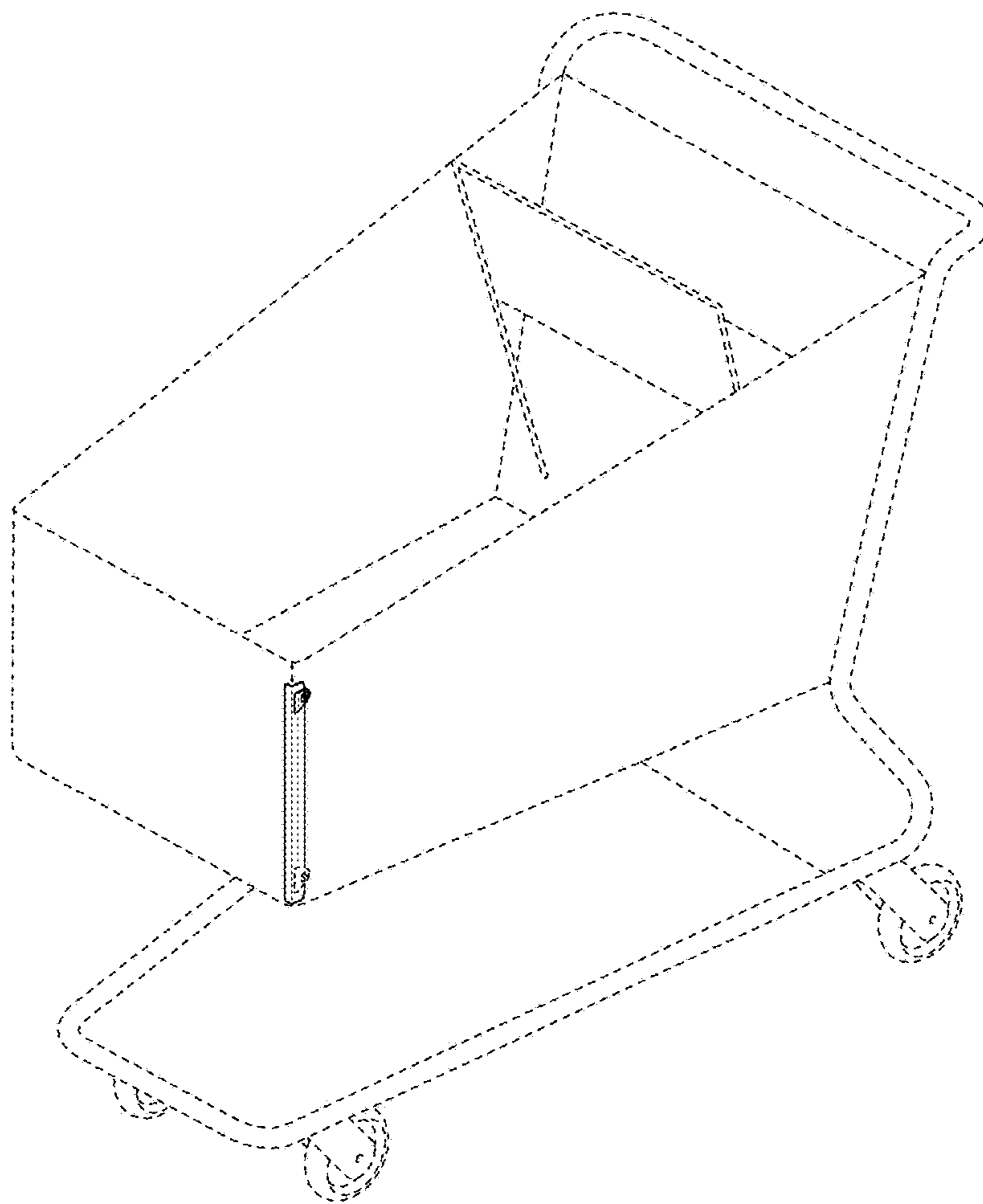

FIG. 18