



US00D789615S

(12) **United States Design Patent**
Pratley

(10) **Patent No.:** **US D789,615 S**
(45) **Date of Patent:** **** Jun. 13, 2017**

- (54) **EAR DEFENDER**
- (71) Applicant: **JSP Limited**, Oxford (GB)
- (72) Inventor: **David Lee Pratley**, Oxford (GB)
- (73) Assignee: **JSP LIMITED**, Oxford (GB)
- (**) Term: **15 Years**
- (21) Appl. No.: **29/547,657**
- (22) Filed: **Dec. 7, 2015**

(30) **Foreign Application Priority Data**

Jun. 23, 2015 (EM) 002724237

(51) **LOC (10) Cl.** **29-02**

(52) **U.S. Cl.**
USPC **D29/112**

(58) **Field of Classification Search**
USPC D29/100, 102, 105, 106, 108, 112, 122;
D14/205, 223, 249
CPC A42B 3/16; A42B 3/163; A42B 3/166;
A61F 11/06; A61F 11/08; A61F 11/10;
A61F 11/12; A61F 11/14; A61F
2011/085; H04R 1/10; H04R 1/1008;
H04R 1/1016; H04R 1/105; H04R
1/1058; H04R 1/1066; H04R 1/1075;
H04R 1/1083; H04R 5/0335; H04R
25/652; H04R 25/654; H04R 25/656;
A63B 71/10

See application file for complete search history.

(56) **References Cited**

U.S. PATENT DOCUMENTS

- 2,883,671 A * 4/1959 Hornickel A61F 11/14
128/866
- D298,670 S * 11/1988 Palmaer D14/205
- D313,092 S * 12/1990 Nilsson D14/205

- D375,584 S * 11/1996 Westerdal D29/112
- D403,126 S * 12/1998 Scanlon D29/112
- D411,200 S * 6/1999 Almqvist D14/192
- D413,413 S * 8/1999 Dillon D14/205
- D427,382 S * 6/2000 Leight D29/112
- 6,151,717 A * 11/2000 Lindgren A61F 11/14
128/867
- D465,616 S * 11/2002 Nilsson A61F 11/14
D29/112
- D509,323 S * 9/2005 Emilsson D29/112
- D541,483 S * 4/2007 Birgersson D29/112
- D663,900 S * 7/2012 Karlsson A61F 11/14
D29/112
- D735,419 S * 7/2015 Rose D29/112
- D736,475 S * 8/2015 Fletcher D29/112
- D747,557 S * 1/2016 Bonney D29/112
- D752,816 S * 3/2016 Fletcher D29/112
- D753,884 S * 4/2016 Bonney D29/112
- D763,518 S * 8/2016 Fletcher D29/112
- D764,717 S * 8/2016 Fletcher D29/112
- D766,520 S * 9/2016 Fletcher D29/112

* cited by examiner

Primary Examiner — Elizabeth J Oswecki

(74) *Attorney, Agent, or Firm* — King & Schickli, PLLC

(57) **CLAIM**

The ornamental design for an ear defender, as shown and described.

DESCRIPTION

FIG. 1 is a front view of an ear defender showing my new design;
FIG. 2 is a side view thereof;
FIG. 3 is a bottom view thereof;
FIG. 4 is a top view thereof;
FIG. 5 is a rear view thereof; and,
FIG. 6 is a perspective view thereof.
All surfaces not shown form no part of the claimed design.

1 Claim, 6 Drawing Sheets

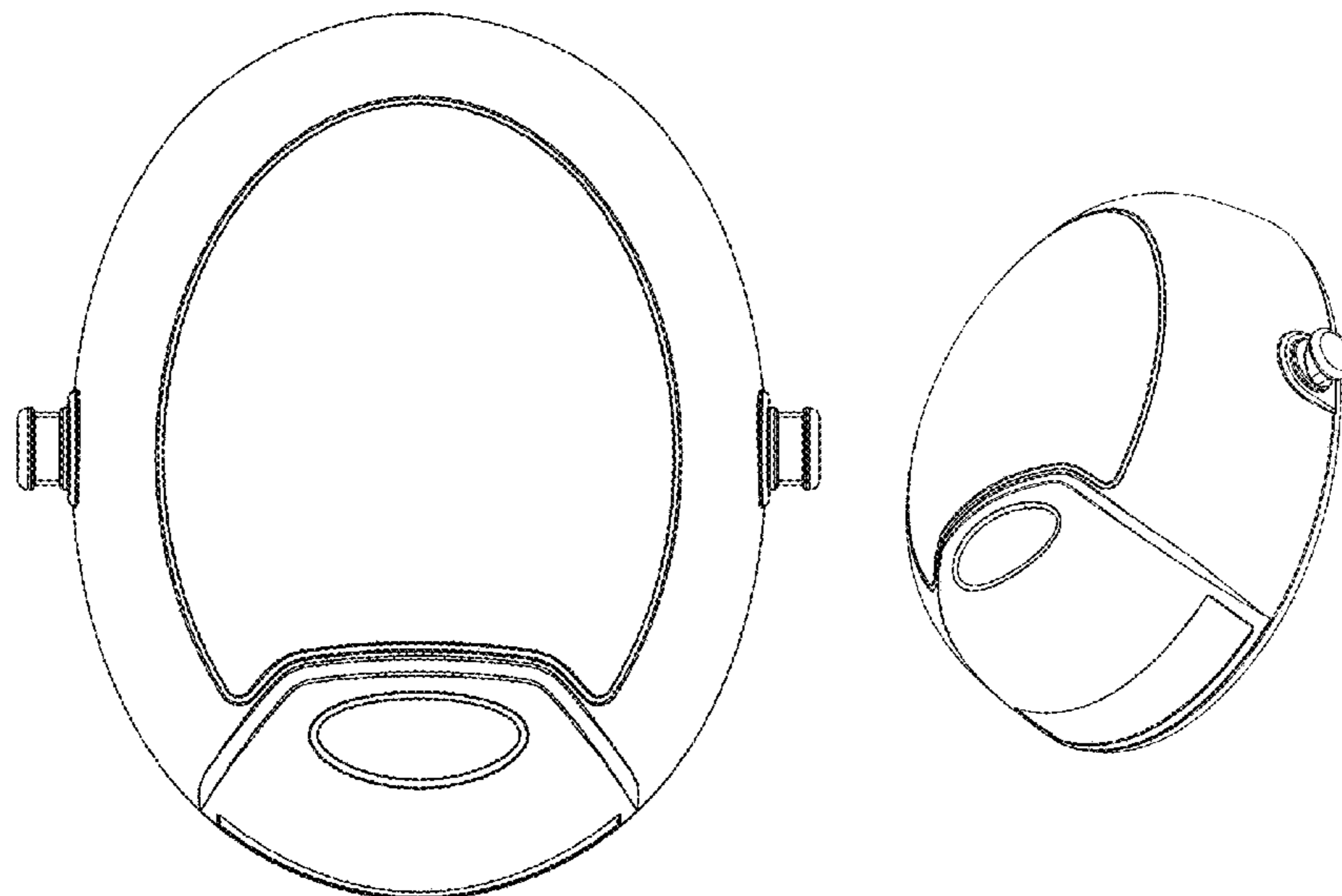

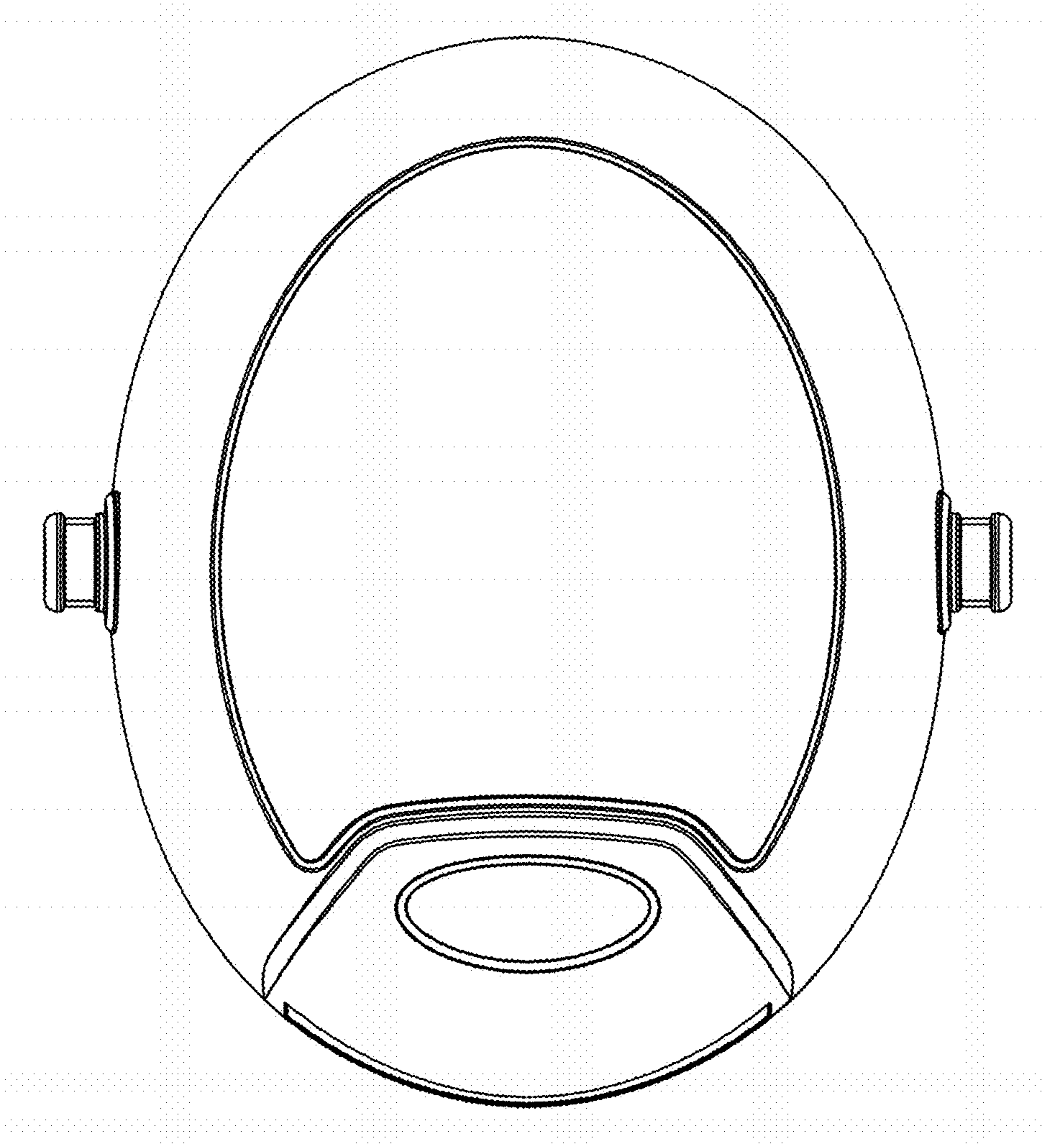

Fig. 1

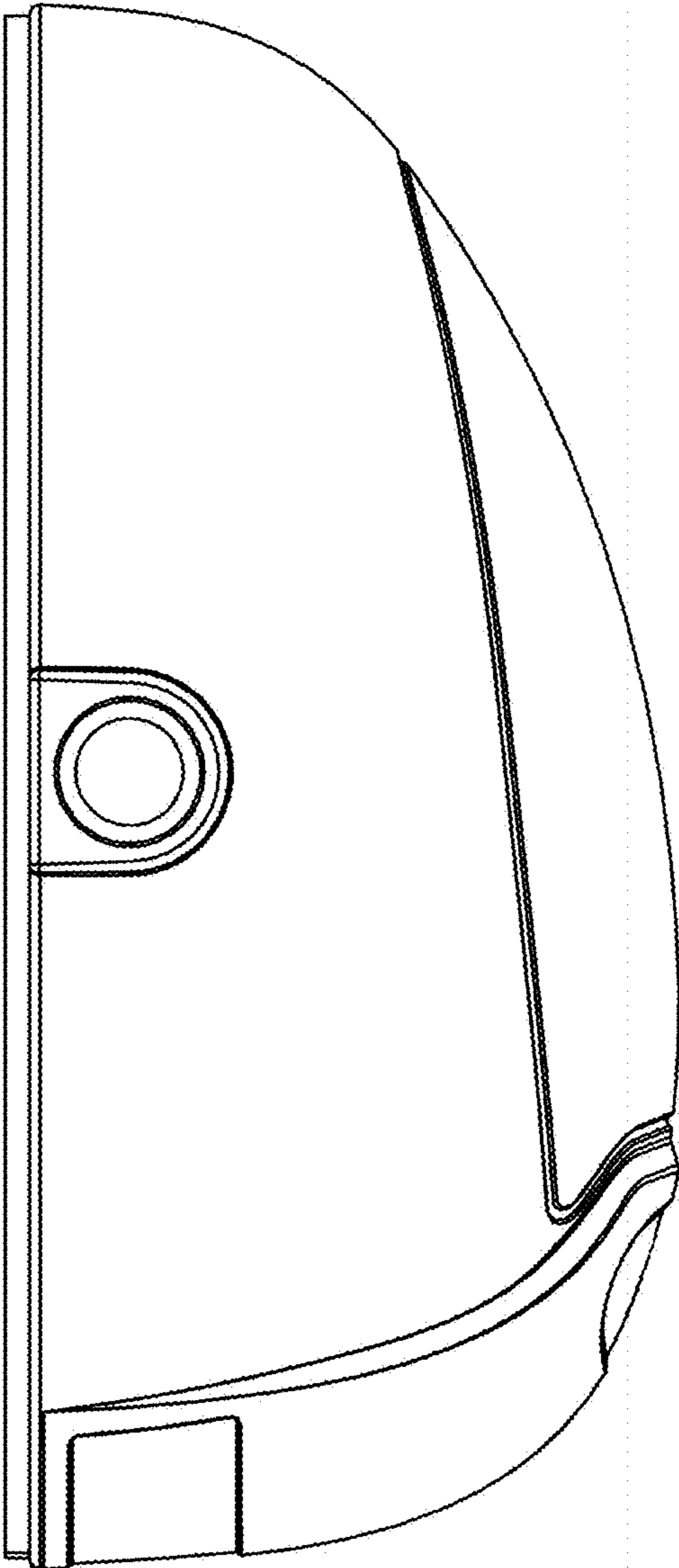

Fig. 2

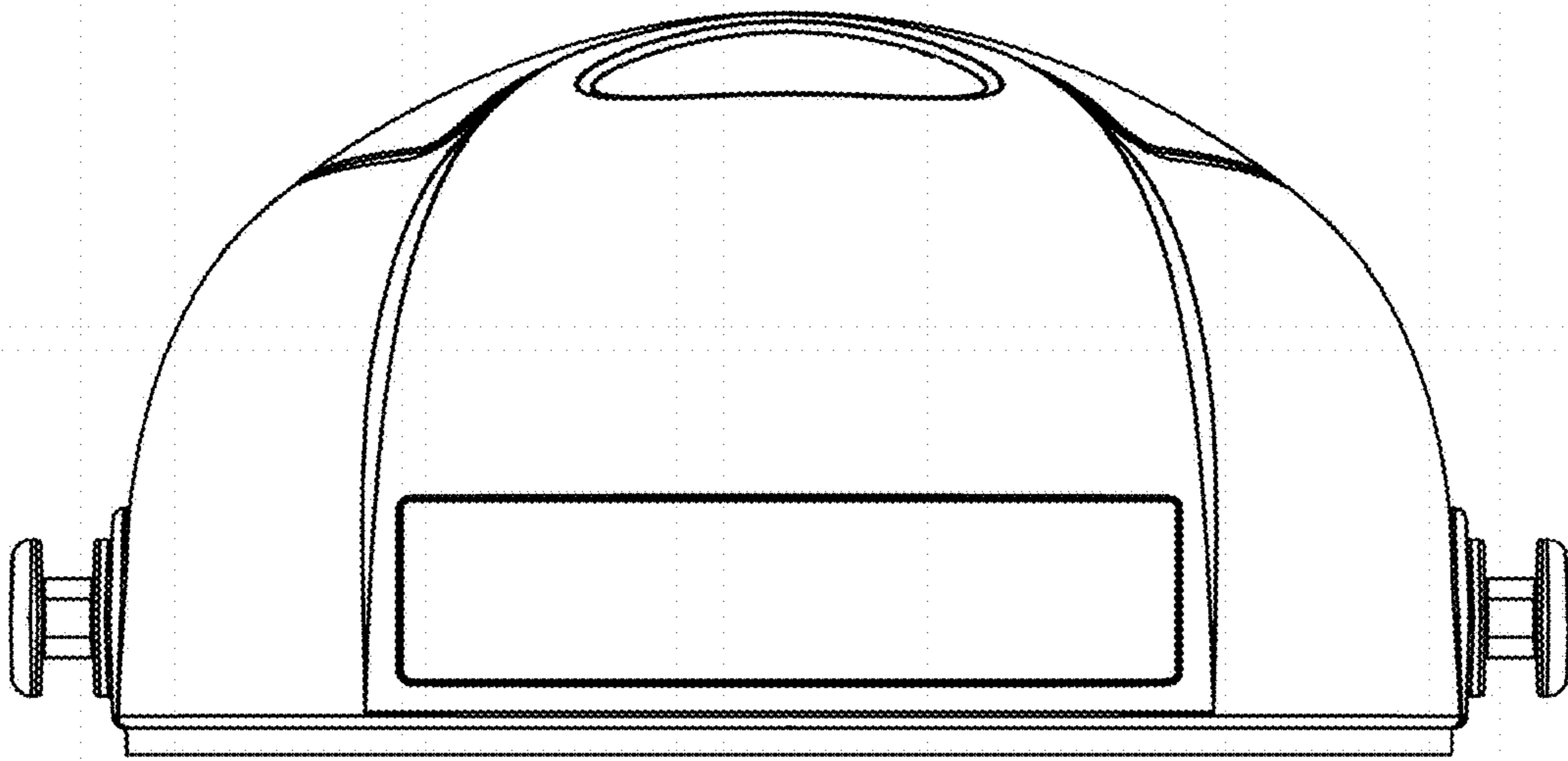

Fig. 3

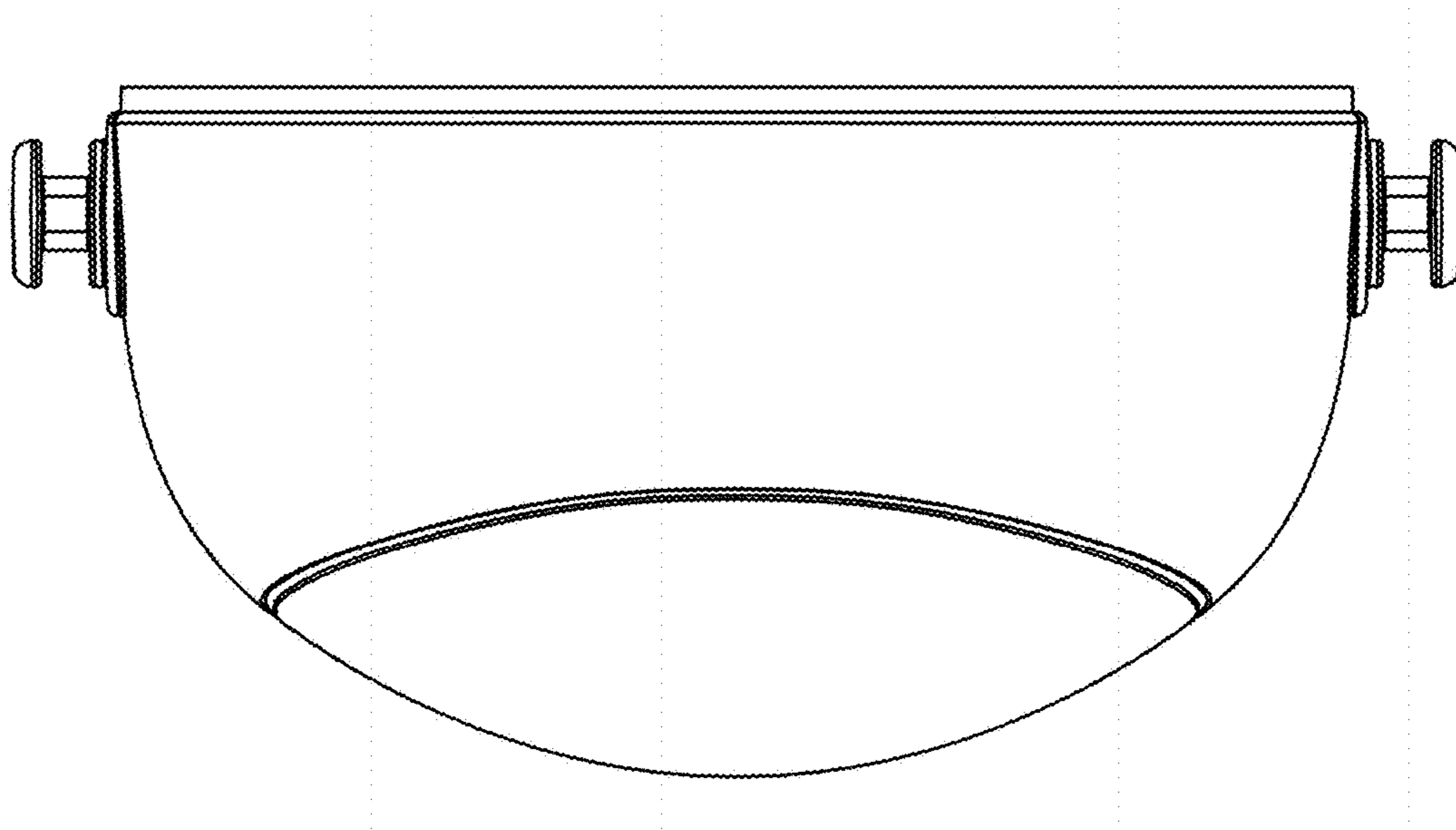

Fig. 4

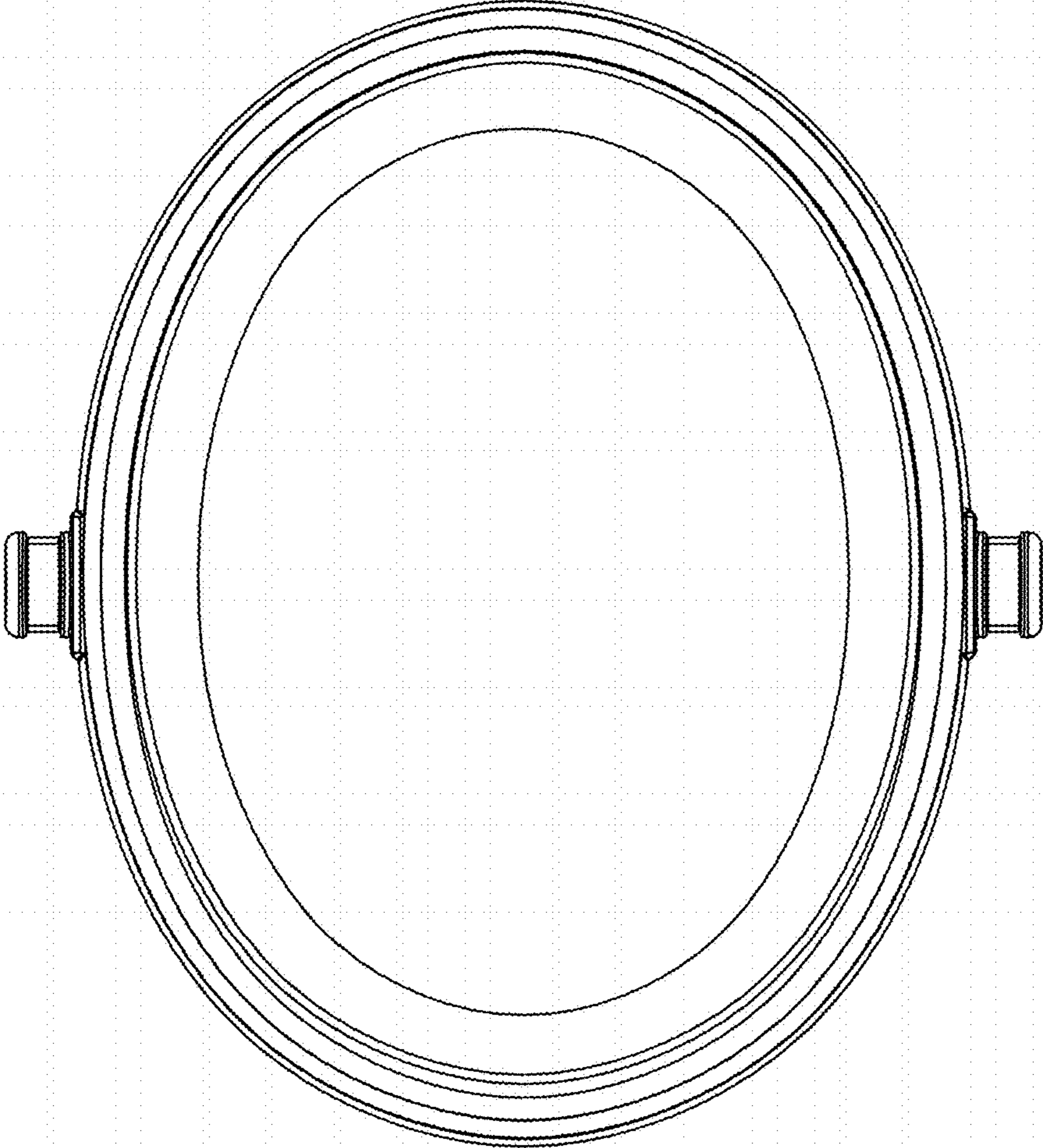

Fig. 5

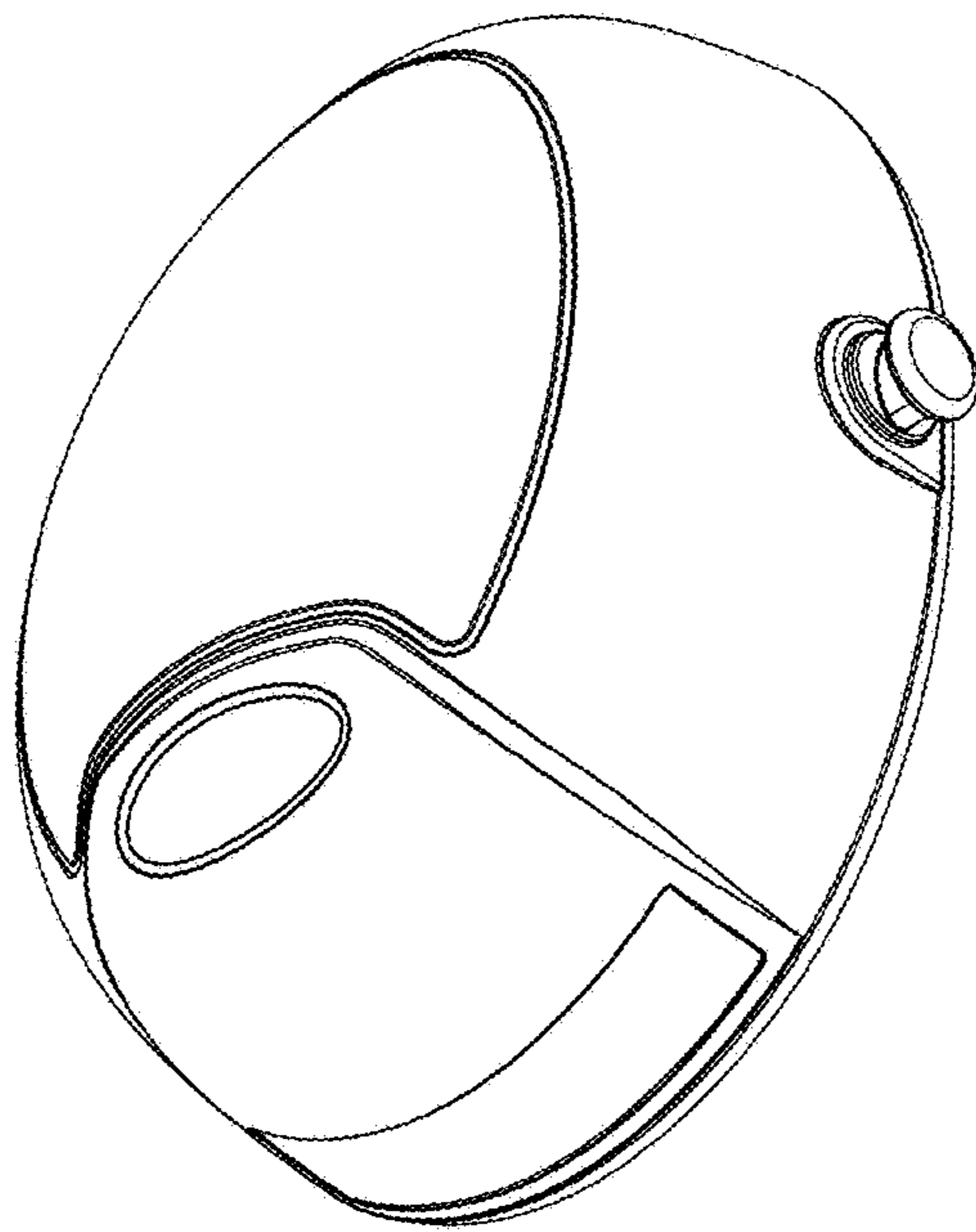

Fig. 6