



US00D789609S

(12) **United States Design Patent**  
**Kong**

(10) **Patent No.:** **US D789,609 S**

(45) **Date of Patent:** **\*\* Jun. 13, 2017**

(54) **RAZOR HANDLE**

(71) Applicant: **Dorco Co., Ltd.**, Seoul (KR)

(72) Inventor: **Nam-Yoon Kong**, Seoul (KR)

(73) Assignee: **Dorco Co., Ltd.**, Seoul (KR)

(\*\*) Term: **15 Years**

(21) Appl. No.: **29/549,692**

(22) Filed: **Dec. 28, 2015**

(30) **Foreign Application Priority Data**

Jun. 25, 2015 (KR) ..... 30-2015-0032158

(51) **LOC (10) Cl.** ..... **28-03**

(52) **U.S. Cl.**  
USPC ..... **D28/48**

(58) **Field of Classification Search**  
USPC ..... D28/46-48  
CPC ..... B26B 21/52-21/528; B26B 21/14-21/38;  
B26B 21/00; B26B 21/08  
See application file for complete search history.

(56) **References Cited**

**U.S. PATENT DOCUMENTS**

D635,718 S \* 4/2011 White, Jr. .... D28/48  
D636,533 S \* 4/2011 Andersen ..... D28/48

D674,552 S \* 1/2013 Barrow ..... D28/48  
D699,395 S \* 2/2014 Bae ..... D28/48  
D730,579 S \* 5/2015 Han ..... D28/48  
D745,215 S \* 12/2015 Go ..... D28/48  
D749,784 S \* 2/2016 Go ..... D28/48  
D750,324 S \* 2/2016 Bae ..... D28/48

\* cited by examiner

*Primary Examiner* — Jennifer Rivard

(74) *Attorney, Agent, or Firm* — Perkins Coie LLP

(57) **CLAIM**

The ornamental design for a razor handle, as shown and described.

**DESCRIPTION**

FIG. 1 is a perspective view of a razor handle showing my new design;  
FIG. 2 is a left side view of the razor handle;  
FIG. 3 is a right side view of the razor handle;  
FIG. 4 is an enlarged front view of the razor handle;  
FIG. 5 is an enlarged rear view of the razor handle;  
FIG. 6 is a top plan view of the razor handle; and,  
FIG. 7 is a bottom plan view of the razor handle.  
The broken lines illustrate a portion of the razor handle and form no part of the claimed design.

**1 Claim, 4 Drawing Sheets**

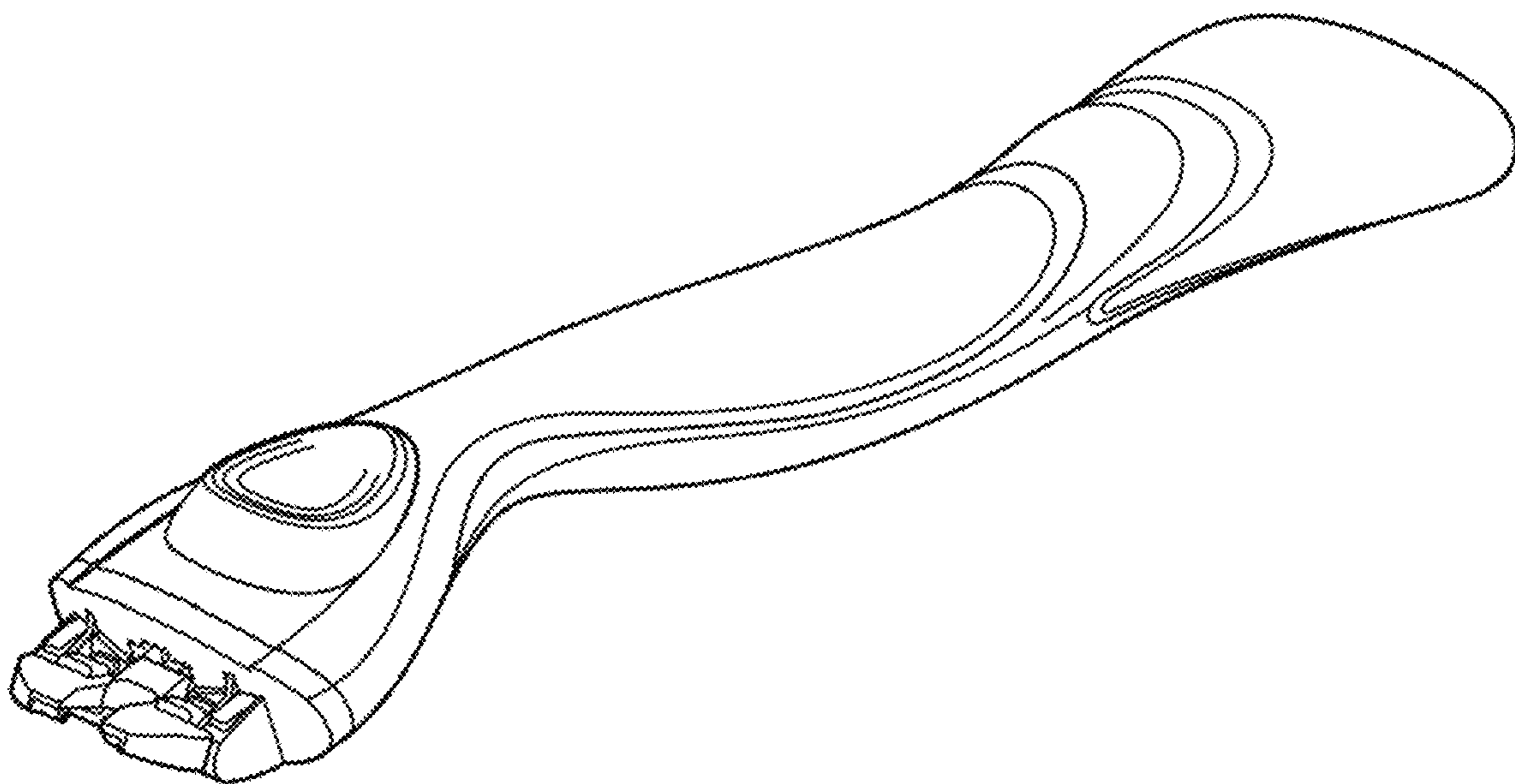

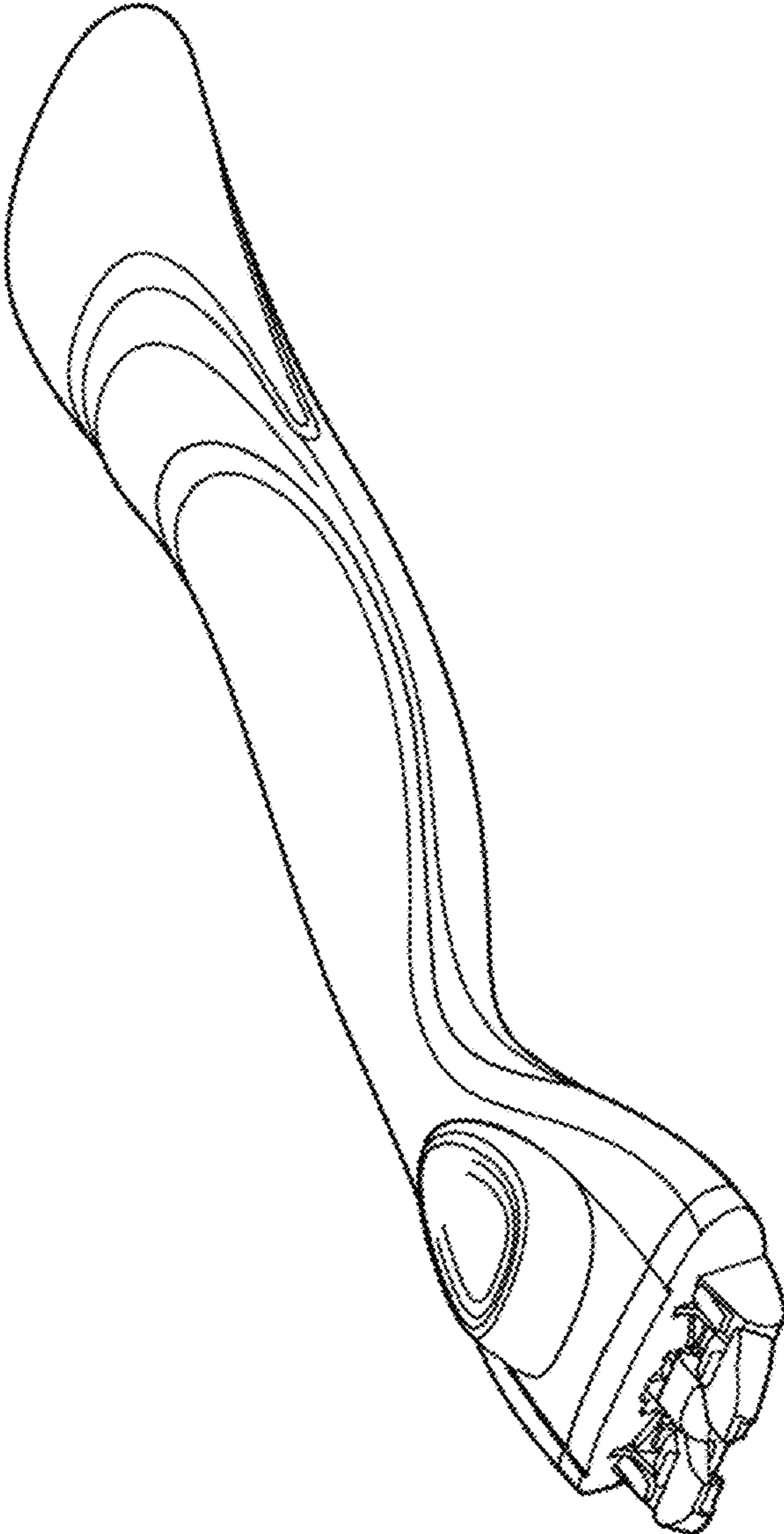

FIG. 1

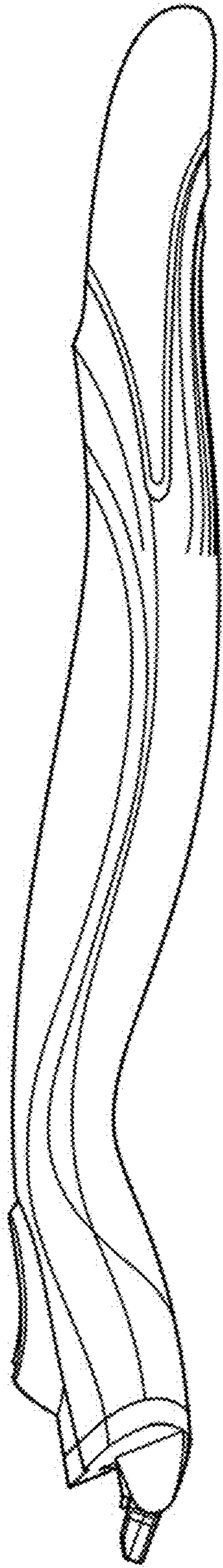

FIG. 2



FIG. 3

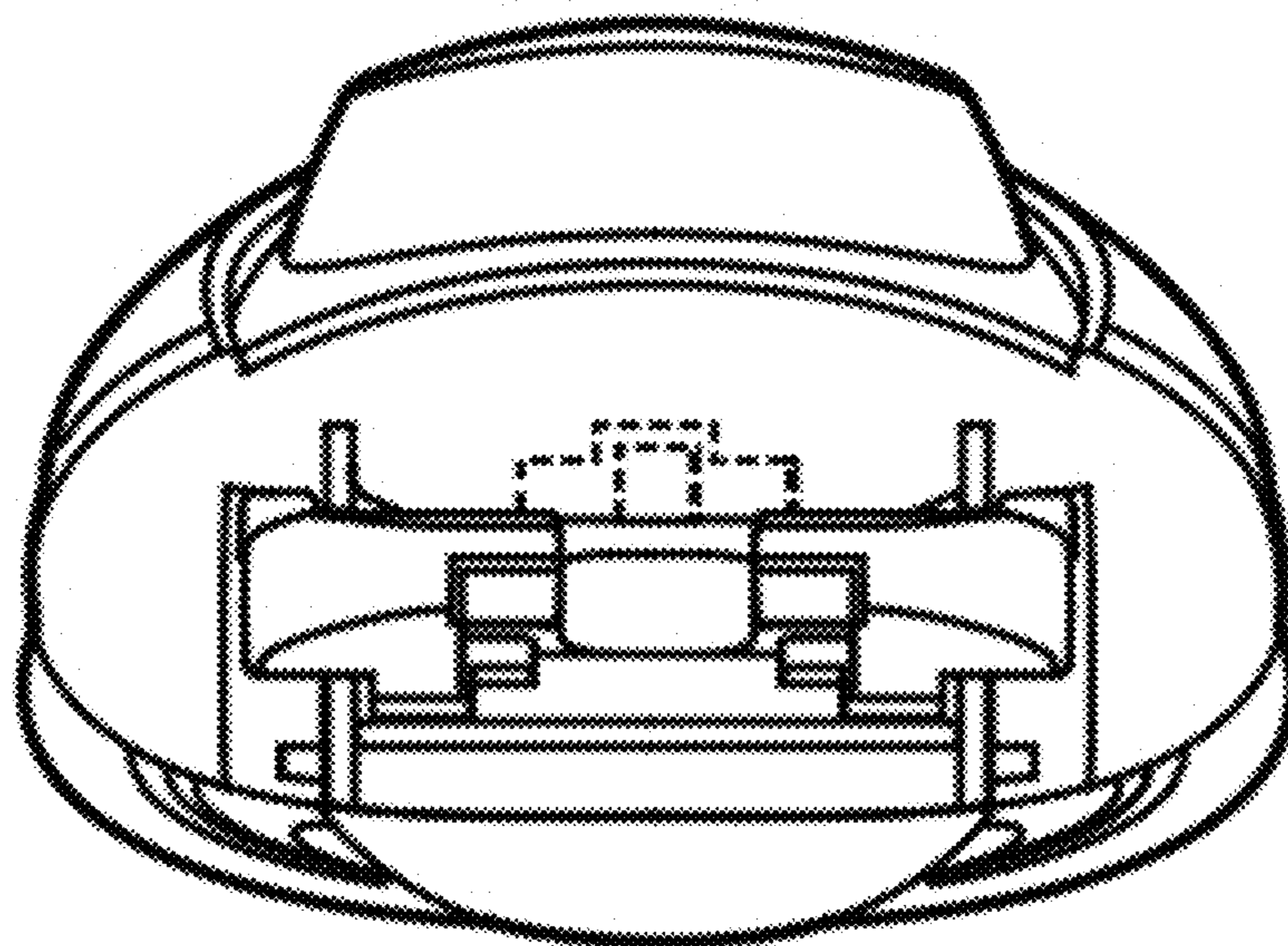

FIG. 4

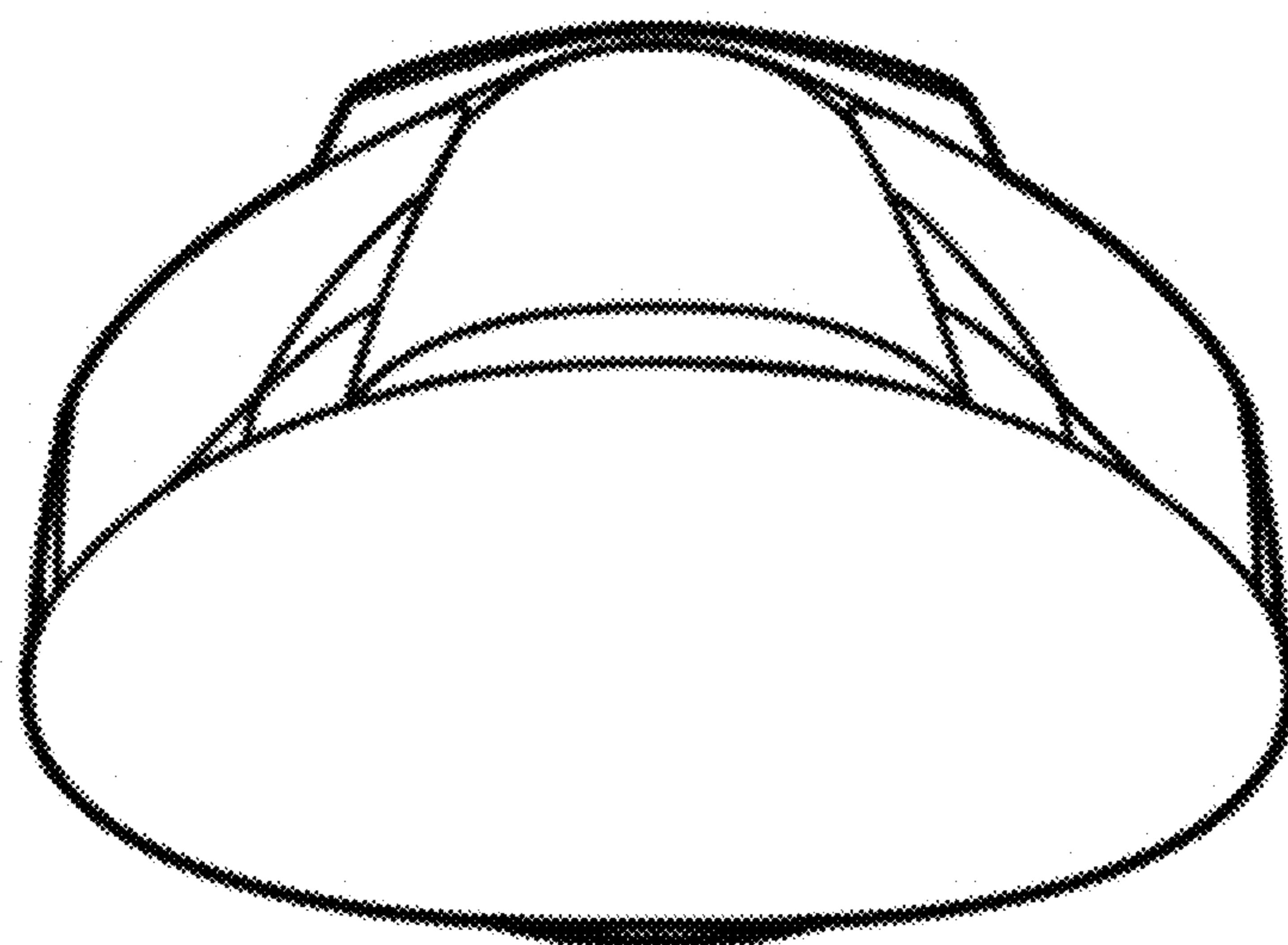

FIG. 5

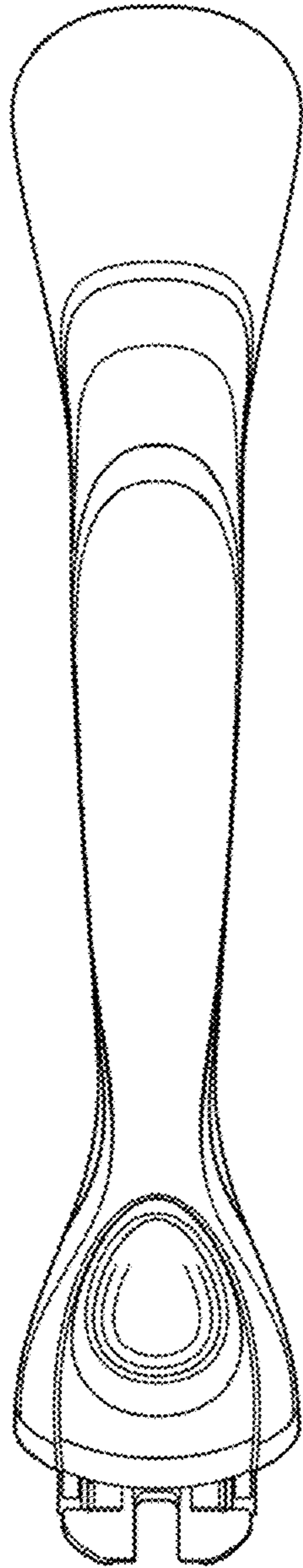

FIG. 6

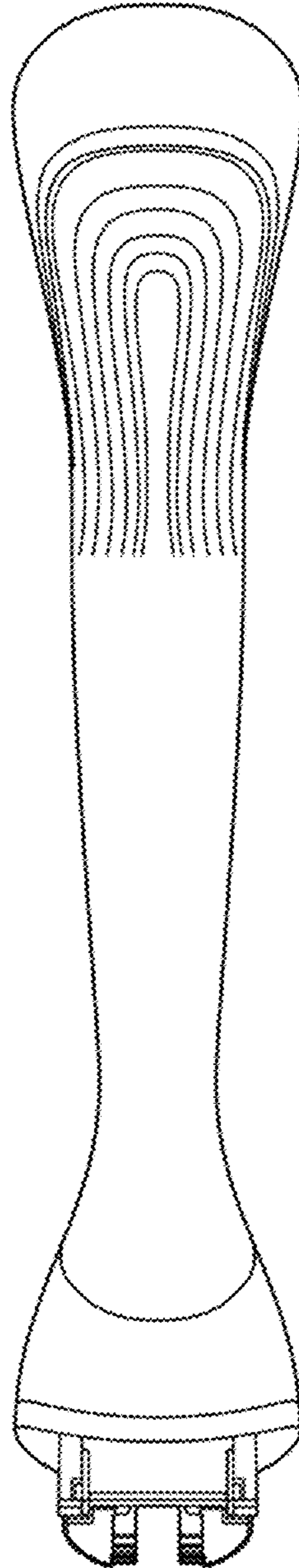

FIG. 7