



US00D789565S

(12) **United States Design Patent**  
**Lopez**

(10) **Patent No.:** **US D789,565 S**

(45) **Date of Patent:** **\*\* Jun. 13, 2017**

- (54) **ROOF ANCHOR**
- (71) Applicant: **WERNER CO.**, Greenville, PA (US)
- (72) Inventor: **Ivan D. Lopez**, Hermitage, PA (US)
- (73) Assignee: **WERNER CO.**, Greenville, PA (US)
- (\*\*) Term: **15 Years**
- (21) Appl. No.: **29/558,270**
- (22) Filed: **Mar. 16, 2016**
- (51) **LOC (10) Cl.** ..... **25-99**
- (52) **U.S. Cl.**  
USPC ..... **D25/199**; D8/354
- (58) **Field of Classification Search**  
USPC ..... D25/199; D8/325, 354, 371, 380, 381,  
D8/349, 367  
CPC ..... A62B 35/0068; A62B 35/04; E04D 13/12;  
E04D 15/00; E04G 21/3261; E04G  
21/328; E04G 21/3214; E04G 21/3276;  
E04G 5/041; E04G 5/043; E04G 3/26;  
E04B 1/38; Y02E 10/47  
See application file for complete search history.

(56) **References Cited**

**U.S. PATENT DOCUMENTS**

- 471,626 A \* 3/1892 Streeter ..... E06C 9/04  
182/189
- 2,969,140 A \* 1/1961 Avetta ..... A45D 27/29  
206/349
- D214,383 S \* 6/1969 Johnson ..... D8/371
- 3,861,632 A \* 1/1975 Siilats ..... F21V 19/0005  
248/224.7
- 4,249,713 A 2/1981 Glynn et al.
- 4,570,403 A \* 2/1986 Dannemiller ..... E04B 1/0007  
52/295
- 4,665,672 A 5/1987 Commins et al.
- 4,685,265 A 8/1987 Cooper
- 4,696,611 A 9/1987 Guay

- 4,723,128 A 2/1988 Gasque, Jr.
- D298,212 S \* 10/1988 Gross ..... D15/9.1
- 4,942,943 A 7/1990 Flaherty
- D310,520 S \* 9/1990 Bedard ..... D14/432
- D313,739 S \* 1/1991 Preston ..... D8/354
- 5,011,106 A 4/1991 Cody
- 5,036,949 A 8/1991 Crocker et al.
- 5,054,576 A 10/1991 Glynn
- 5,074,350 A \* 12/1991 Carter ..... E06B 9/323  
16/94 R
- 5,137,112 A 8/1992 Nichols
- 5,248,021 A \* 9/1993 Nichols ..... A62B 35/04  
182/3
- 5,287,944 A 2/1994 Woodyard
- 5,361,558 A 11/1994 Thornton et al.
- 5,519,976 A \* 5/1996 Gee ..... E04B 9/18  
24/67 AR
- 5,553,685 A 9/1996 Cook
- 5,636,704 A 6/1997 Castaneda

(Continued)

*Primary Examiner* — Vy Koenig  
*Assistant Examiner* — Kimberly Barnes  
 (74) *Attorney, Agent, or Firm* — Eckert Seamans Cherin  
 & Mellott, LLC; Nathaniel C. Wilks

(57) **CLAIM**

The ornamental design for a roof anchor, as shown and described.

**DESCRIPTION**

FIG. 1 is an upper front right perspective view of the roof anchor;  
 FIG. 2 is a front elevational view thereof;  
 FIG. 3 is a top plan view thereof;  
 FIG. 4 is a left side elevational view thereof;  
 FIG. 5 is a rear elevational view thereof;  
 FIG. 6 is a right side elevational view thereof; and,  
 FIG. 7 is a bottom plan view thereof.  
 The broken lines illustrate portions of the roof anchor that form no part of the claimed design.

**1 Claim, 7 Drawing Sheets**

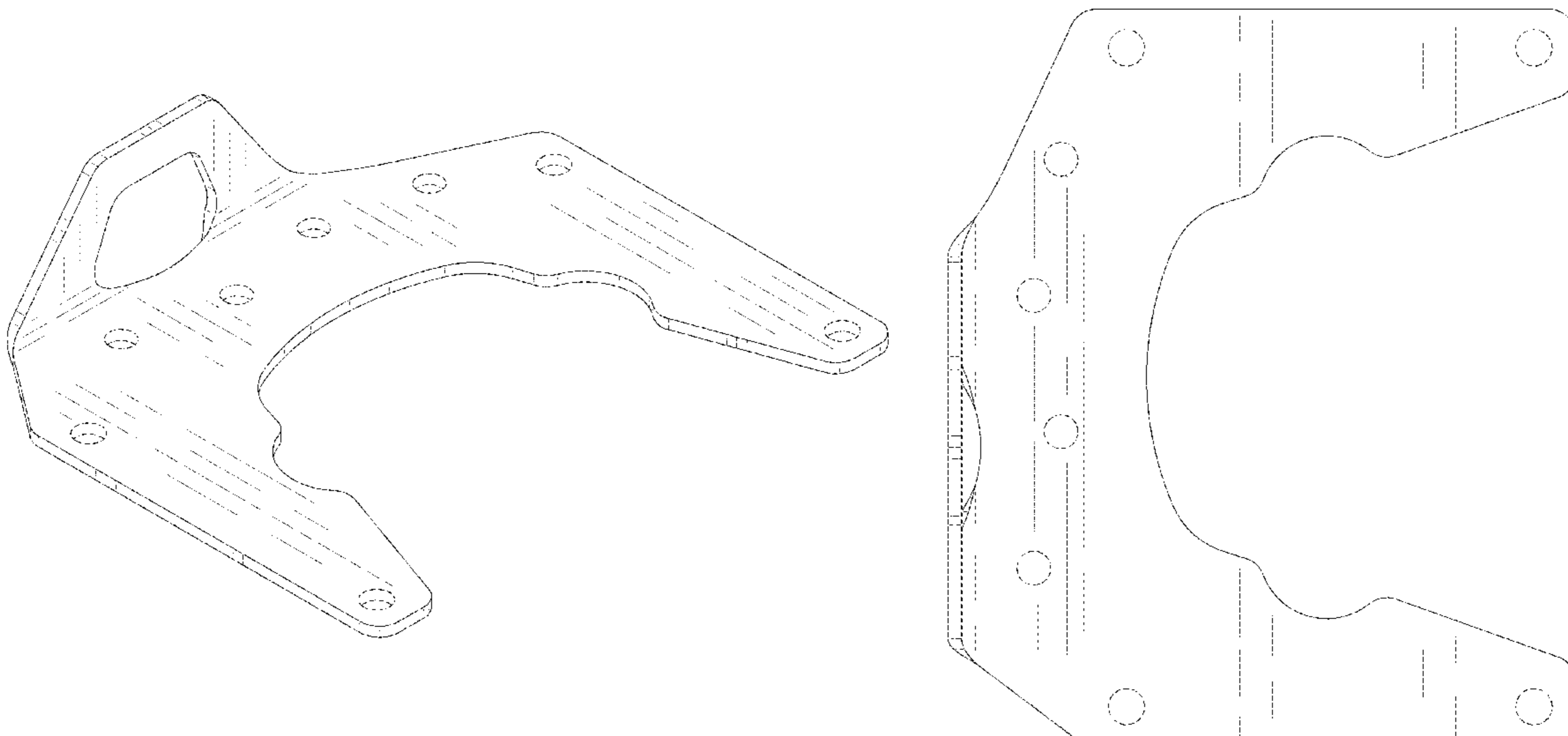

(56)

References Cited

U.S. PATENT DOCUMENTS

5,678,379	A *	10/1997	Quattrociochi .....	E04B 1/2608 403/231	D649,016	S *	11/2011	Rasmussen .....	D8/354
5,687,535	A	11/1997	Rohlf		D668,423	S *	10/2012	Brockington .....	D12/203
D387,443	S *	12/1997	Blankenbiller .....	D25/199	D668,562	S *	10/2012	Madrack .....	D10/65
5,730,407	A	3/1998	Ostobrod		8,292,245	B2	10/2012	Schindler et al.	
5,829,203	A	11/1998	Ealer, Sr.		D682,079	S *	5/2013	Chou .....	D8/380
5,845,452	A	12/1998	Pantano		D710,273	S *	8/2014	LeBlanc .....	D12/179
5,878,534	A	3/1999	Gleave		8,863,460	B2 *	10/2014	Hohmann, Jr. ....	E04B 1/4178 52/379
5,896,719	A	4/1999	Thornton		9,003,715	B2	4/2015	Nurdogan	
5,901,523	A *	5/1999	Tasi .....	A47B 57/54 248/223.41	9,091,056	B2 *	7/2015	Stauffer .....	E04B 1/40
6,035,557	A *	3/2000	Mills .....	A43B 3/163 36/113	D736,066	S *	8/2015	Hull .....	D8/354
6,098,746	A	8/2000	Castaneda		D760,066	S *	6/2016	Krenek .....	D8/354
6,668,509	B1	12/2003	Krebs		9,577,417	B2 *	2/2017	Stechmann .....	H02G 3/32
6,729,101	B2 *	5/2004	Macri .....	E04D 13/12 182/45	2004/0007150	A1	1/2004	Gleave	
D525,408	S *	7/2006	Nitadori .....	D34/35	2004/0035993	A1	2/2004	Curtin	
7,380,373	B2	6/2008	Crookston		2006/0059844	A1	3/2006	Ely	
7,429,023	B2 *	9/2008	Morrow .....	E04B 1/003 248/200	2007/0272811	A1	11/2007	Baake	
7,665,248	B2	2/2010	Blackford		2008/0271407	A1	11/2008	Snider et al.	
7,854,421	B2	12/2010	Florent		2010/0200330	A1 *	8/2010	Crookston .....	E04G 21/3261 182/3
D635,007	S *	3/2011	Takahara .....	D8/349	2012/0222370	A1 *	9/2012	Crookston .....	E04G 21/3276 52/173.1
					2012/0317892	A1	12/2012	Crookston	
					2013/0067848	A1	3/2013	Ferris	
					2014/0182218	A1	7/2014	O'Donnell	
					2015/0107184	A1	4/2015	Nichols, Jr.	

\* cited by examiner

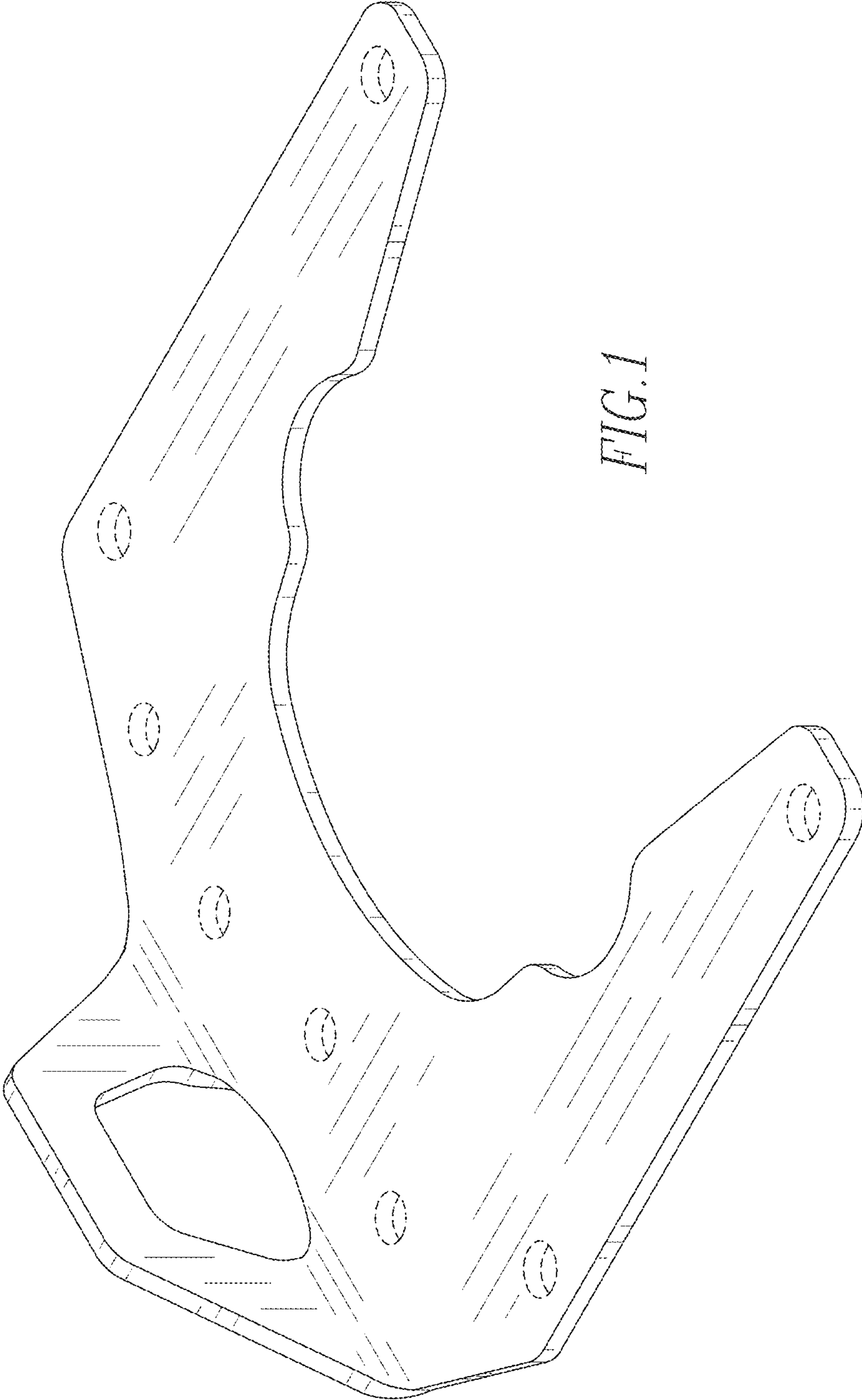

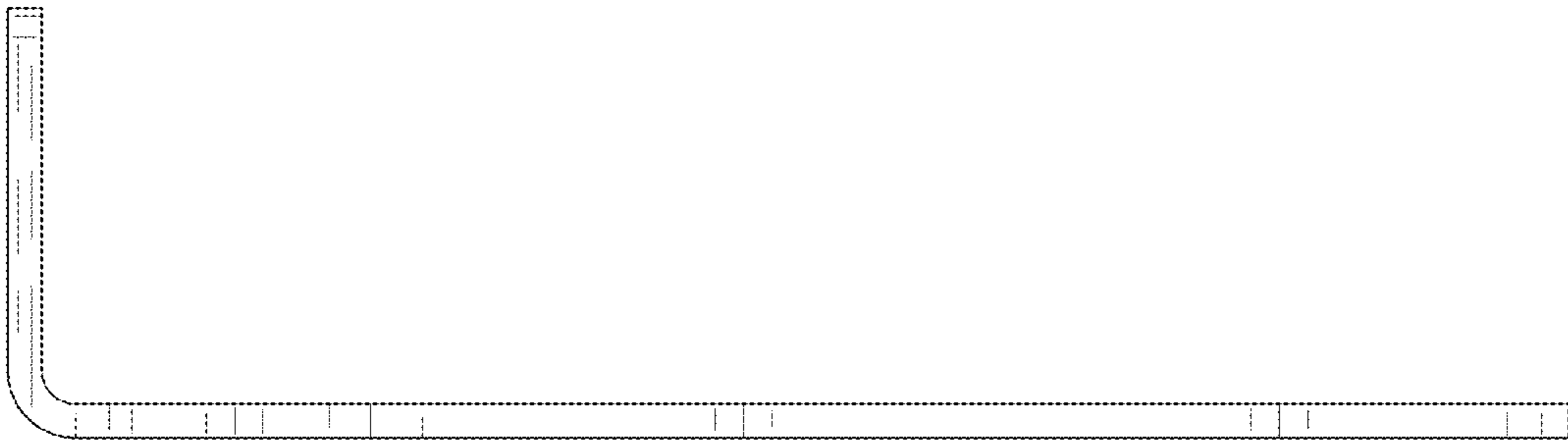

*FIG. 2*

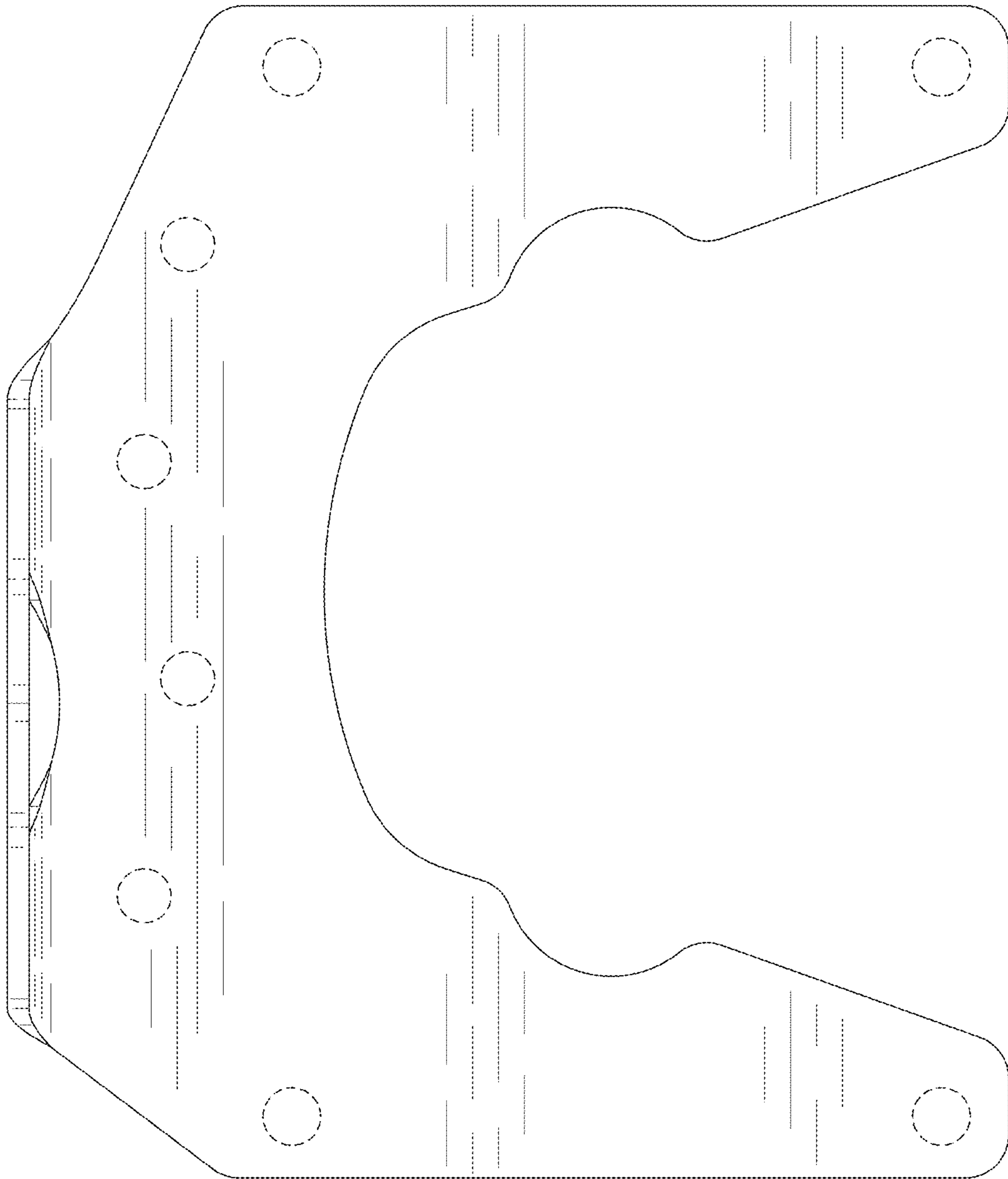

FIG. 3

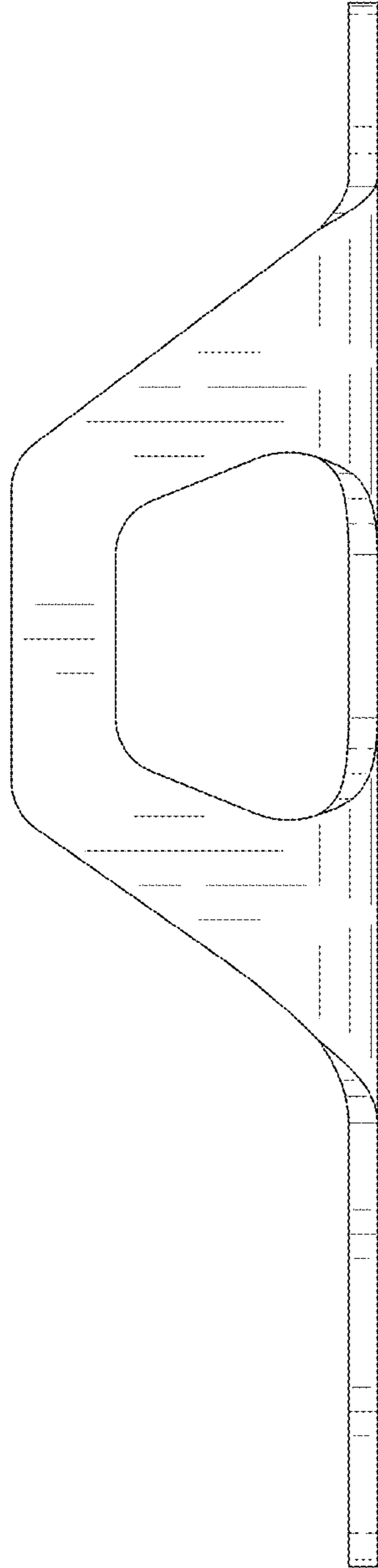
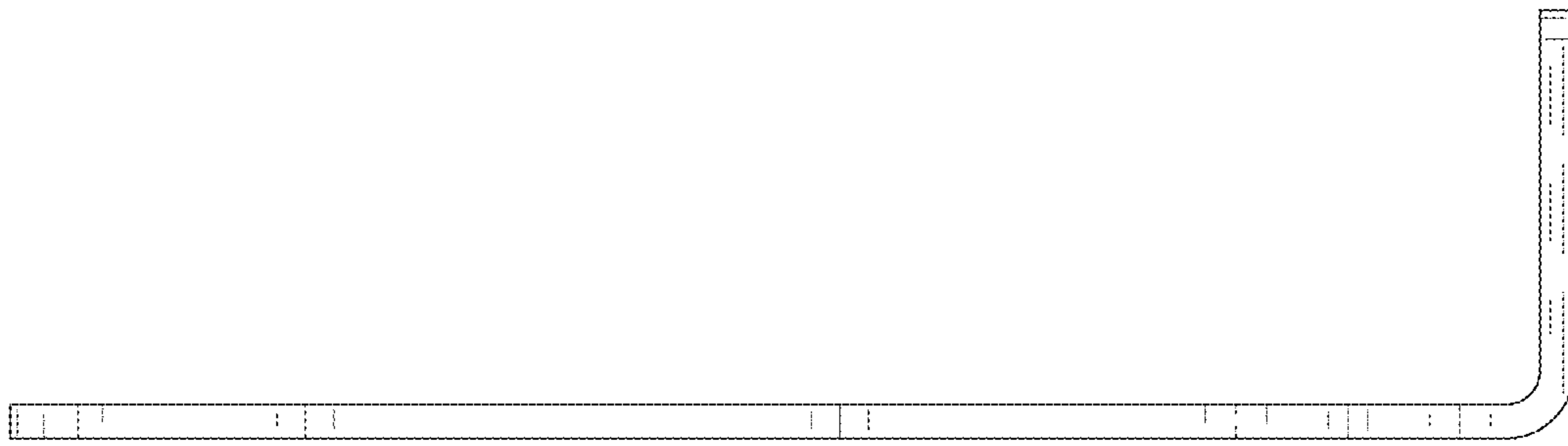

FIG. 4



*FIG. 5*

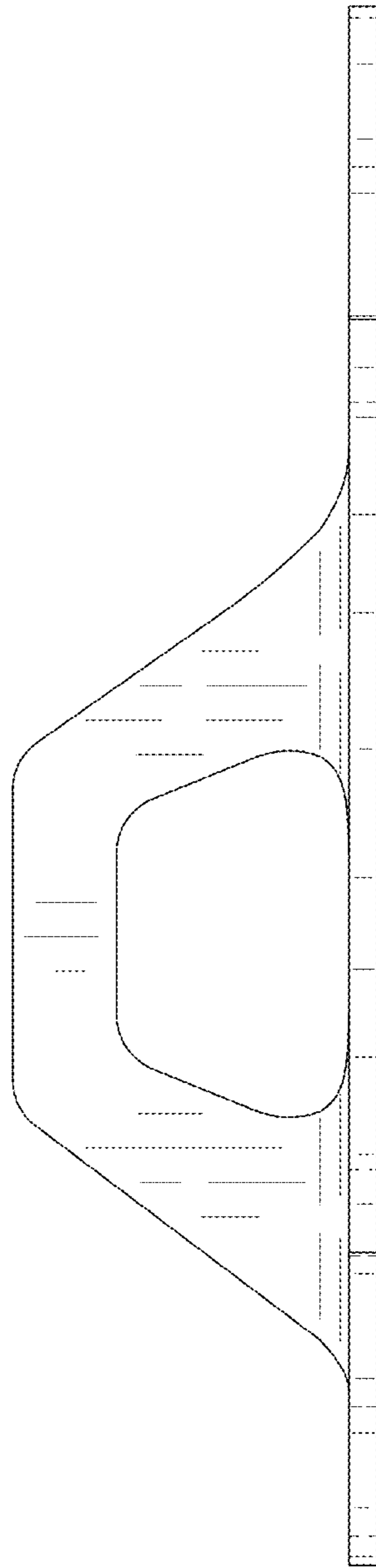

FIG. 6



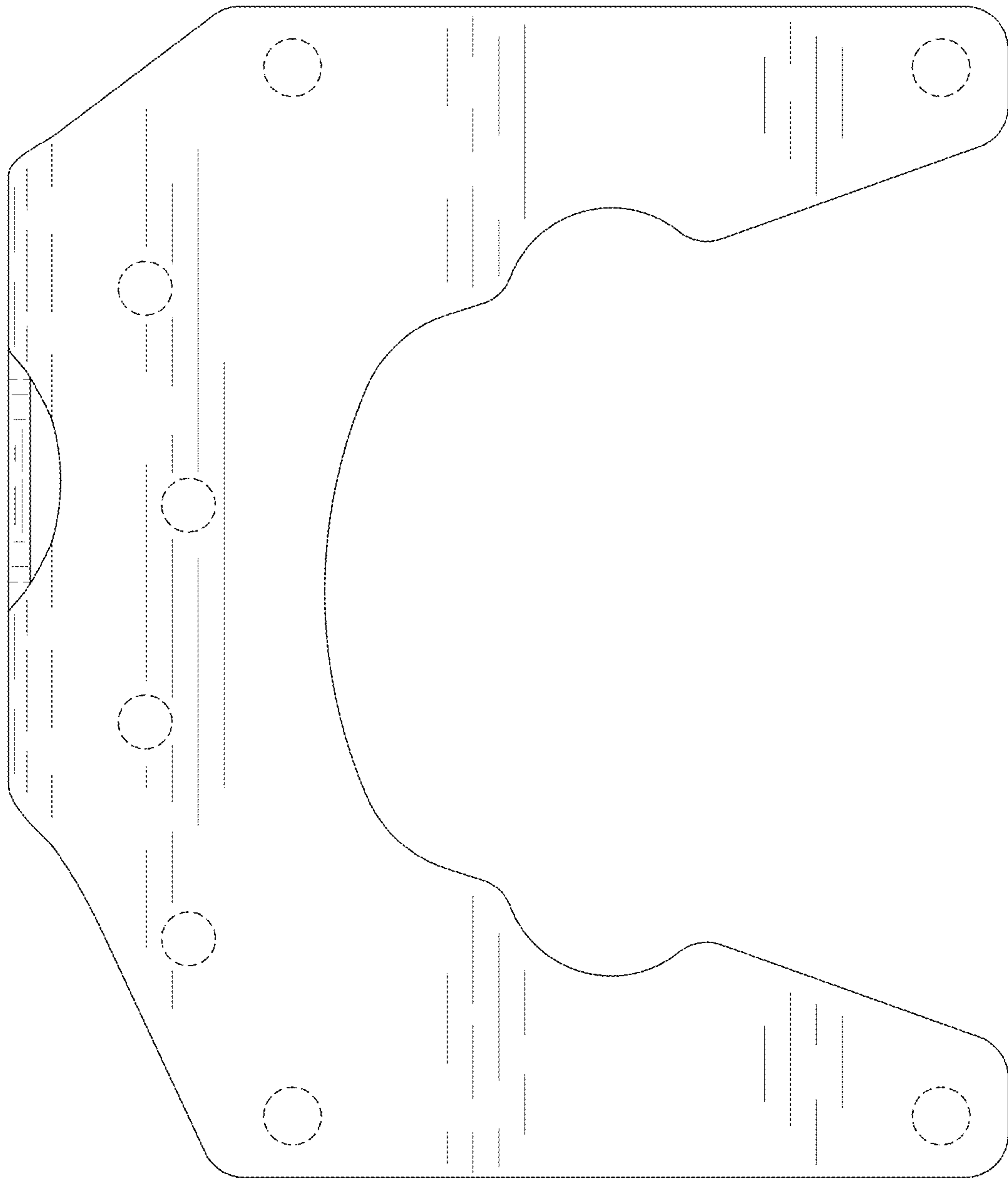

FIG. 7