



US00D789530S

(12) **United States Design Patent**  
**Casey et al.**

(10) **Patent No.:** **US D789,530 S**  
(45) **Date of Patent:** **\*\* Jun. 13, 2017**

- (54) **RETRACTOR BLADE**
- (71) Applicant: **NuVasive, Inc.**, San Diego, CA (US)
- (72) Inventors: **Niall Casey**, San Diego, CA (US);  
**James Coleman Lee**, San Diego, CA (US);  
**Ali A. Shoroghi**, San Diego, CA (US);  
**Gurvinder S. Deol**, Raleigh, NC (US);  
**Bradley Alan Heiges**, Savannah, GA (US);  
**Nitin Khanna**, Chicago, IL (US);  
**Troy B. Woolley**, Erie, CO (US)
- (73) Assignee: **NuVasive, Inc.**, San Diego, CA (US)
- (\*\*) Term: **15 Years**
- (21) Appl. No.: **29/530,069**
- (22) Filed: **Jun. 12, 2015**

3,384,077 A 5/1968 Gauthier  
 3,509,873 A 5/1970 Karlin  
 3,522,799 A 8/1970 Gauthier  
 3,724,449 A 4/1973 Gauthier  
 (Continued)

**FOREIGN PATENT DOCUMENTS**

CA 1142826 3/1983  
 CN 201341901 11/2009  
 (Continued)

*Primary Examiner* — Bridget L Eland  
*Assistant Examiner* — Lauren McVey  
 (74) *Attorney, Agent, or Firm* — Nicholas J. Landau;  
 Michele P. Marron; Bradley Arant Boult Cummings LLP

(57) **CLAIM**

The ornamental design for a retractor blade, substantially as shown and described.

**DESCRIPTION**

FIG. 1 is a front perspective view of a first embodiment of a retractor blade showing our new design;  
 FIG. 2 is a back perspective view of FIG. 1;  
 FIG. 3 is a front view of FIG. 1;  
 FIG. 4 is a back view of FIG. 1;  
 FIG. 5 is a left side view of FIG. 1;  
 FIG. 6 is a right side view of FIG. 1;  
 FIG. 7 is a front perspective view of a second embodiment of a retractor blade showing our new design;  
 FIG. 8 is a back perspective view of FIG. 7;  
 FIG. 9 is a front view of FIG. 7;  
 FIG. 10 is a back view of FIG. 7;  
 FIG. 11 is a right side view of FIG. 7; and,  
 FIG. 12 is a left side view of FIG. 7.

The broken lines immediately adjacent the claim represent the bounds of the claimed design while all other broken lines are directed to environment and are for illustrative purposes only; the broken lines form no part of the claimed design.

**1 Claim, 6 Drawing Sheets**

**Related U.S. Application Data**

- (63) Continuation of application No. 13/601,986, filed on Aug. 31, 2012, now Pat. No. 9,113,853.
- (51) **LOC (10) Cl.** ..... **24-02**
- (52) **U.S. Cl.**  
USPC ..... **D24/135**
- (58) **Field of Classification Search**  
USPC ..... D24/135, 136, 133  
CPC . A61B 17/02; A61B 17/0206; A61B 17/0218;  
A61B 2017/2837  
See application file for complete search history.

(56) **References Cited**

**U.S. PATENT DOCUMENTS**

186,637 A 1/1877 Tanner  
 1,223,812 A 4/1917 Listiak  
 1,456,116 A 5/1923 Bessesen  
 2,807,259 A 9/1957 Guerriero  
 3,030,948 A 4/1962 Loeffler

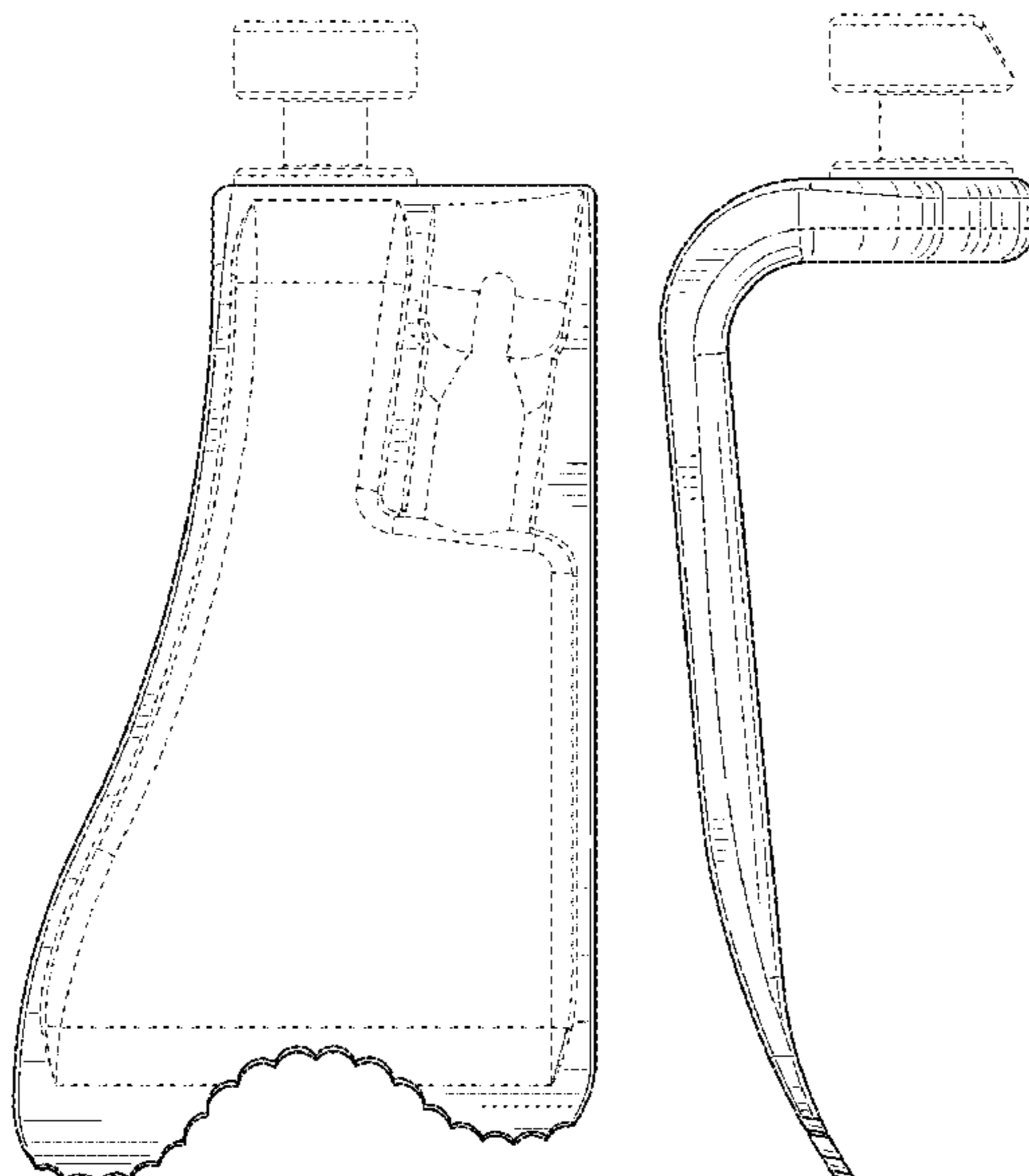

(56)

References Cited

U.S. PATENT DOCUMENTS

3,749,088 A	7/1973	Kohlmann		7,182,731 B2	2/2007	Nguyen	
3,965,890 A	6/1976	Gauthier		7,214,186 B2	5/2007	Ritland	
4,024,859 A	5/1977	Slepyan		7,235,048 B2	6/2007	Rein	
4,048,987 A *	9/1977	Hurson	A61B 17/0293 600/234	7,294,104 B2	11/2007	Person	
4,116,232 A	9/1978	Rabban		7,374,534 B2	5/2008	Dalton	
4,151,837 A	5/1979	Millard		7,396,328 B2	7/2008	Penenberg	
4,156,424 A	5/1979	Burgin		D575,398 S *	8/2008	Lash	D24/135
4,165,746 A	8/1979	Burgin		7,455,639 B2	11/2008	Ritland	
4,457,300 A	7/1984	Budde		7,473,223 B2	1/2009	Fetzer	
4,461,284 A	7/1984	Fackler		7,473,269 B1	1/2009	Hynes	
4,686,972 A	8/1987	Kurland		7,537,565 B2	5/2009	Bass	
4,702,230 A	10/1987	Pelta		7,569,014 B2	8/2009	Bass	
4,747,394 A	5/1988	Watanabe		7,588,537 B2	9/2009	Bass	
4,747,395 A	5/1988	Brief		7,654,954 B1	2/2010	Phillips	
4,817,587 A	4/1989	Janese		7,722,618 B2	5/2010	Estes	
4,829,985 A	5/1989	Couetil		D617,456 S *	6/2010	Ott	D24/135
4,852,552 A	8/1989	Chaux		7,744,530 B2	6/2010	Person	
4,881,525 A	11/1989	Williams		7,753,844 B2	7/2010	Sharratt	
4,934,352 A	6/1990	Sullivan		7,758,501 B2	7/2010	Frasier	
5,052,373 A	10/1991	Michelson		7,850,608 B2	12/2010	Hamada	
D343,235 S *	1/1994	LeVahn	D24/135	7,909,829 B2	3/2011	Patel	
5,468,241 A	11/1995	Metz-Stavenhagen		7,909,848 B2	3/2011	Patel	
5,512,038 A	4/1996	O'Neal		7,927,337 B2	4/2011	Keller	
D369,860 S	5/1996	Koros		7,931,589 B2	4/2011	Cohen	
5,733,290 A	3/1998	McCue		7,935,053 B2	5/2011	Karpowicz	
5,772,583 A	6/1998	Wright		7,946,982 B2	5/2011	Hamada	
5,795,291 A	8/1998	Koros		7,959,564 B2	6/2011	Ritland	
5,846,192 A	12/1998	Teixido		7,981,031 B2	7/2011	Frasier	
5,865,730 A	2/1999	Fox		D642,679 S *	8/2011	Raven, III	D24/135
5,882,298 A	3/1999	Sharratt		8,062,217 B2	11/2011	Boucher	
5,893,831 A	4/1999	Koros		8,066,710 B2	11/2011	Estes	
5,902,233 A	5/1999	Farley		D674,896 S *	1/2013	Bender	D24/135
5,931,777 A	8/1999	Sava		8,636,655 B1	1/2014	Childs	
5,944,658 A	8/1999	Koros		8,784,101 B1 *	7/2014	Engeron	A61B 17/02 433/140
5,967,974 A	10/1999	Nicholas		8,864,661 B2 *	10/2014	Olsen	A61B 17/0293 600/210
5,984,865 A	11/1999	Farley		D726,909 S *	4/2015	Bennett	D24/136
5,993,385 A	11/1999	Johnston		9,113,853 B1 *	8/2015	Casey	A61B 17/0206
6,042,540 A	3/2000	Johnston		2005/0192486 A1	9/2005	Hamel	
6,042,542 A	3/2000	Koros		2005/0240081 A1	10/2005	Eliachar	
D430,294 S *	8/2000	Nathanson	D24/135	2006/0183978 A1	8/2006	Howard	
D430,668 S *	9/2000	Koros	D24/135	2006/0206009 A1	9/2006	Von Wald	
6,200,263 B1	3/2001	Person		2007/0038033 A1	2/2007	Jones	
6,206,826 B1	3/2001	Mathews		2007/0073112 A1	3/2007	Holmes	
6,206,828 B1	3/2001	Wright		2007/0083086 A1	4/2007	LeVahn	
6,213,941 B1	4/2001	Benetti		2007/0129608 A1	6/2007	Sandhu	
6,224,545 B1	5/2001	Cocchia		2007/0208228 A1	9/2007	Pavento	
6,234,961 B1	5/2001	Gray		2007/0238932 A1	10/2007	Jones	
6,241,729 B1	6/2001	Estes		2008/0071145 A1	3/2008	Bjork	
6,264,396 B1	7/2001	Dobrovolny		2008/0114208 A1	5/2008	Hutton	
6,296,609 B1	10/2001	Brau		2008/0146881 A1	6/2008	Alimi	
6,322,500 B1	11/2001	Sikora		2008/0249372 A1	10/2008	Reglos	
6,340,345 B1	1/2002	Lees		2009/0012370 A1	1/2009	Gutierrez	
6,416,465 B2	7/2002	Brau		2009/0012527 A1	1/2009	Mignucci	
6,506,151 B2	1/2003	Estes		2009/0076333 A1	3/2009	Bjork	
6,524,238 B2	2/2003	Velikaris		2009/0076516 A1	3/2009	Lowry	
6,602,190 B2	8/2003	Dobrovolny		2009/0105547 A1	4/2009	Vayser	
6,648,818 B2	11/2003	Cartier		2009/0124861 A1	5/2009	Fetzer	
6,685,632 B1	2/2004	Hu		2009/0227845 A1	9/2009	Lo	
6,692,434 B2	2/2004	Ritland		2010/0081885 A1	4/2010	Wing	
6,733,444 B2	5/2004	Phillips		2010/0113885 A1	5/2010	Mcbride	
6,860,850 B2	3/2005	Phillips		2010/0217089 A1	8/2010	Farley	
6,887,197 B2	5/2005	Phillips		2010/0298647 A1	11/2010	Black	
6,887,198 B2	5/2005	Phillips		2010/0298648 A1	11/2010	Gray	
6,929,606 B2	8/2005	Ritland		2010/0312068 A1	12/2010	Dalton	
D510,768 S *	10/2005	Farley	D24/135	2011/0004067 A1	1/2011	Marchek	
6,951,538 B2	10/2005	Ritland		2011/0034781 A1	2/2011	Loftus	
7,001,333 B2	2/2006	Hamel		2011/0130793 A1	6/2011	Woolley	
7,014,609 B2	3/2006	Cartier		2011/0137130 A1	6/2011	Thalgott	
7,029,472 B1	4/2006	Fortin		2011/0144450 A1	6/2011	Paolitto	
7,056,287 B2	6/2006	Taylor		2011/0172494 A1	7/2011	Bass	
7,108,698 B2	9/2006	Robbins		2011/0201897 A1	8/2011	Bertagnoli	
7,147,599 B2	12/2006	Phillips		2011/0208008 A1	8/2011	Michaeli	
7,166,073 B2	1/2007	Ritland		2011/0224497 A1	9/2011	Weiman	
7,182,729 B2	2/2007	Abdelgany		2011/0245836 A1	10/2011	Hamada	

(56)

References Cited

FOREIGN PATENT DOCUMENTS

U.S. PATENT DOCUMENTS

2011/0257487 A1 10/2011 Thalgott  
 2011/0301423 A1 12/2011 Koros  
 2012/0083662 A1 4/2012 Hamada  
 2012/0130180 A1 5/2012 Pell  
 2012/0172670 A1 7/2012 Hamada  
 2012/0197300 A1 8/2012 Loftus  
 2012/0245432 A1 9/2012 Karpowicz  
 2012/0265021 A1 10/2012 Nottmeier  
 2012/0330106 A1 12/2012 Wright  
 2013/0046147 A1 2/2013 Nichter  
 2013/0123581 A1 5/2013 Fritzinger  
 2013/0158359 A1 6/2013 Predick  
 2013/0245383 A1 9/2013 Friedrich  
 2013/0261401 A1 10/2013 Hawkins  
 2013/0261402 A1 10/2013 Hawkins  
 2013/0303859 A1 11/2013 Nowak  
 2013/0345520 A1 12/2013 Hamada  
 2014/0024900 A1 1/2014 Capote  
 2014/0066718 A1 3/2014 Fiechter  
 2014/0066941 A1 3/2014 Mignucci

CN	201537102	8/2010	
DE	29722605	2/1998	
EP	1949860	3/2010	
EP	2394584	12/2011	
FR	2788958	8/2000	
GB	1520832	8/1978	
JP	10277043	10/1998	
WO	WO-9838921	9/1998	
WO	WO-2004037070	5/2004	
WO	WO-2004047650	6/2004	
WO	WO-2007002405	1/2007	
WO	WO-2010057980	5/2010	
WO	WO 2011022787	3/2011	..... A61B 17/02
WO	WO-2012005914	1/2012	
WO	WO-2012040206	3/2012	
WO	WO-2012093368	7/2012	
WO	WO-2012125975	9/2012	
WO	WO-2013000105	1/2013	
WO	WO-2013033630	3/2013	
WO	WO-2013052827	4/2013	

\* cited by examiner

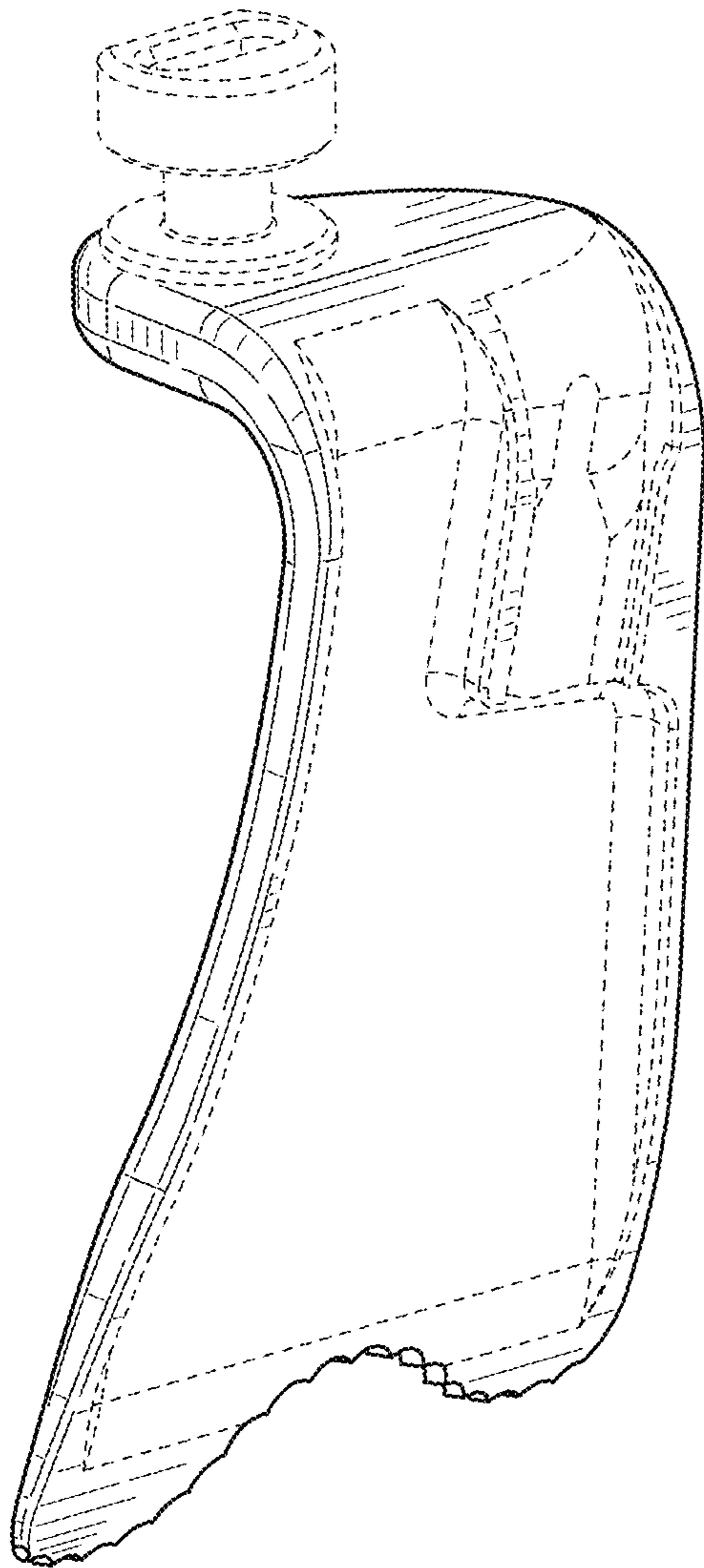

FIG. 1

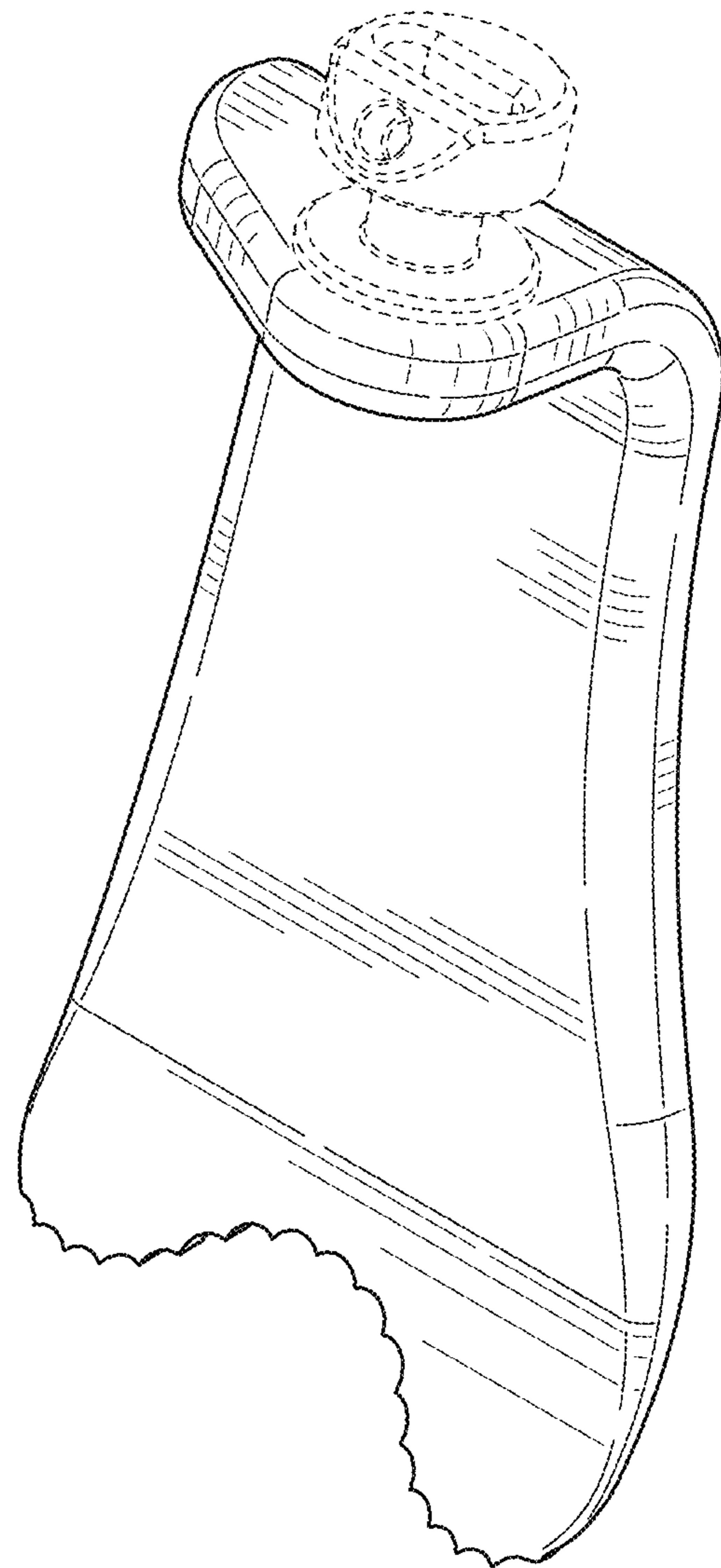

FIG. 2

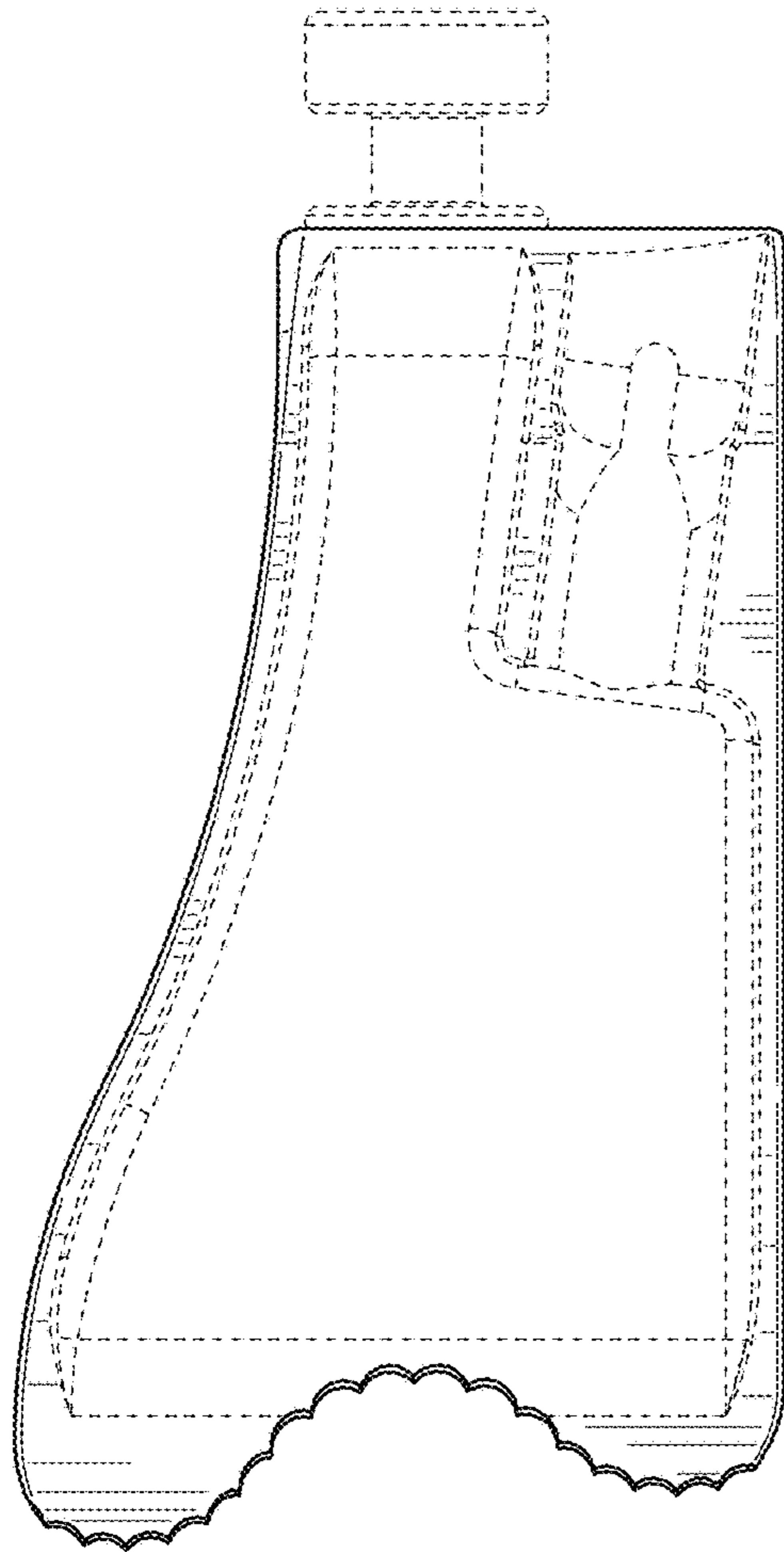

FIG. 3

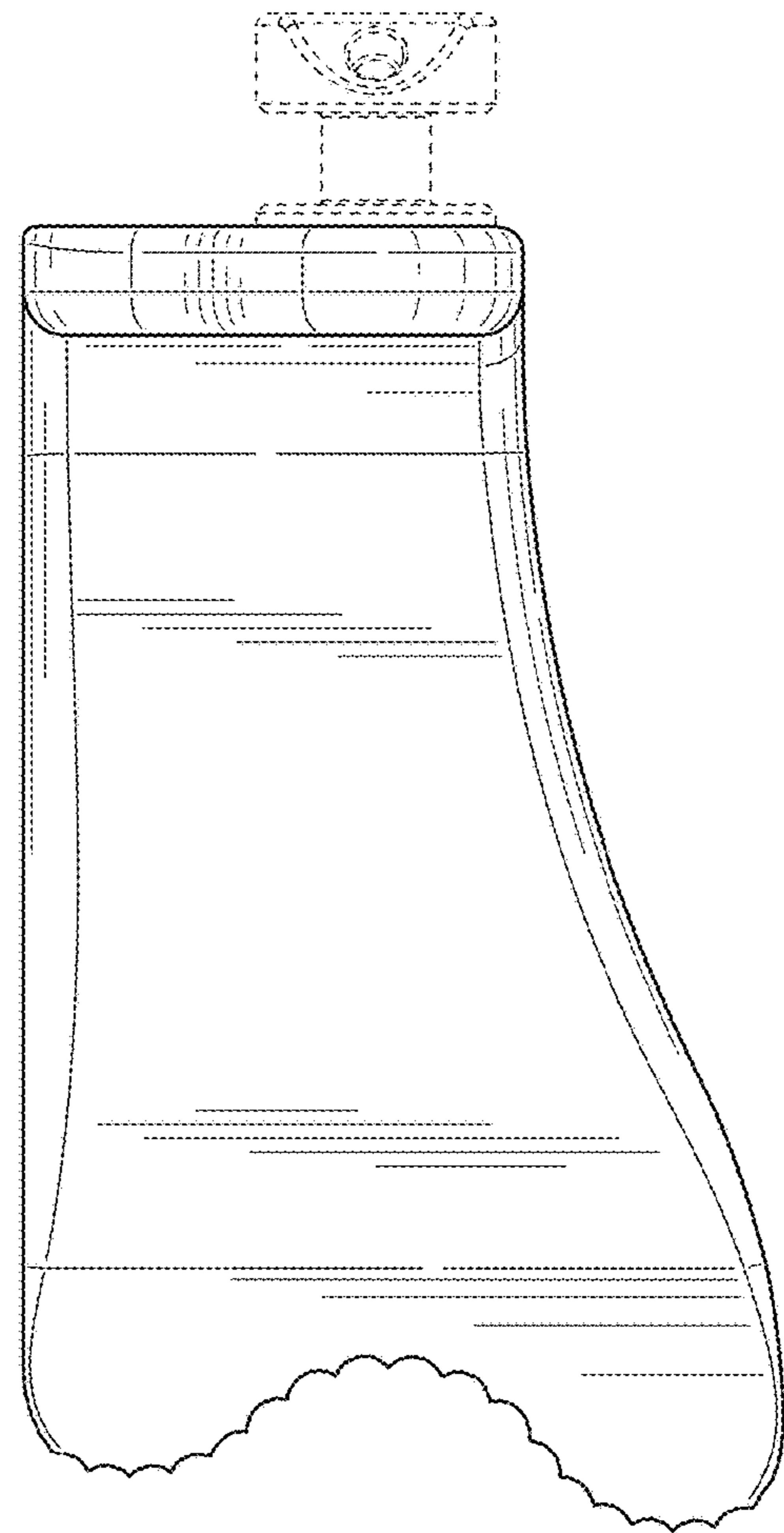

FIG. 4

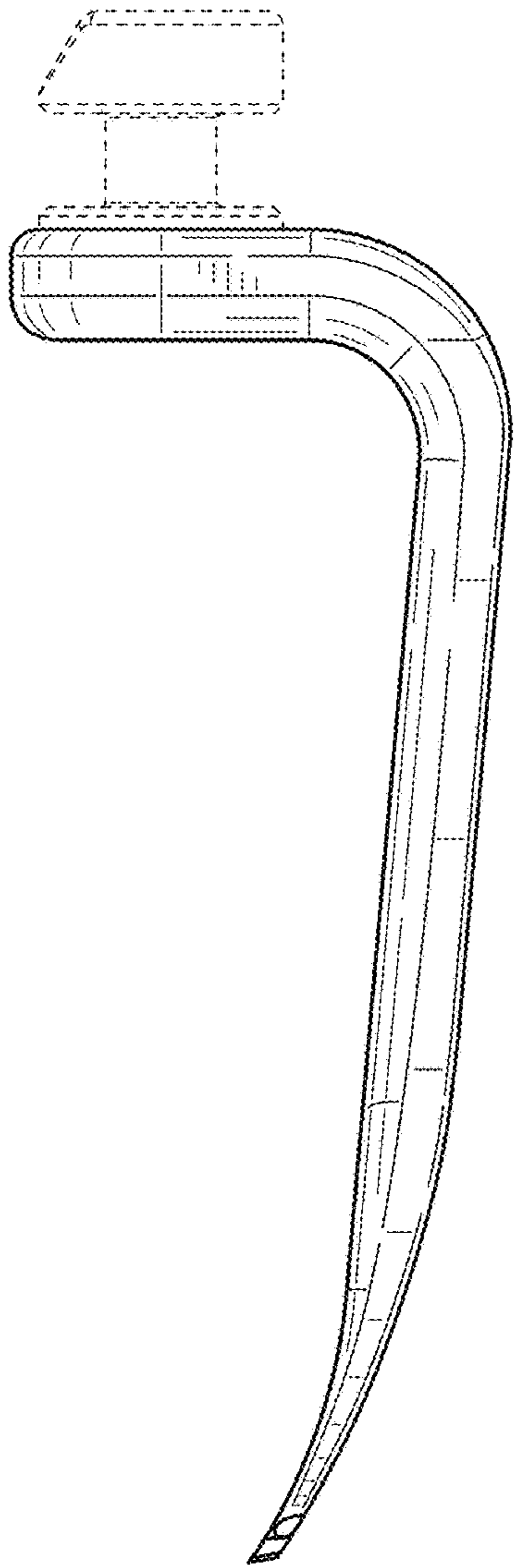

FIG. 5

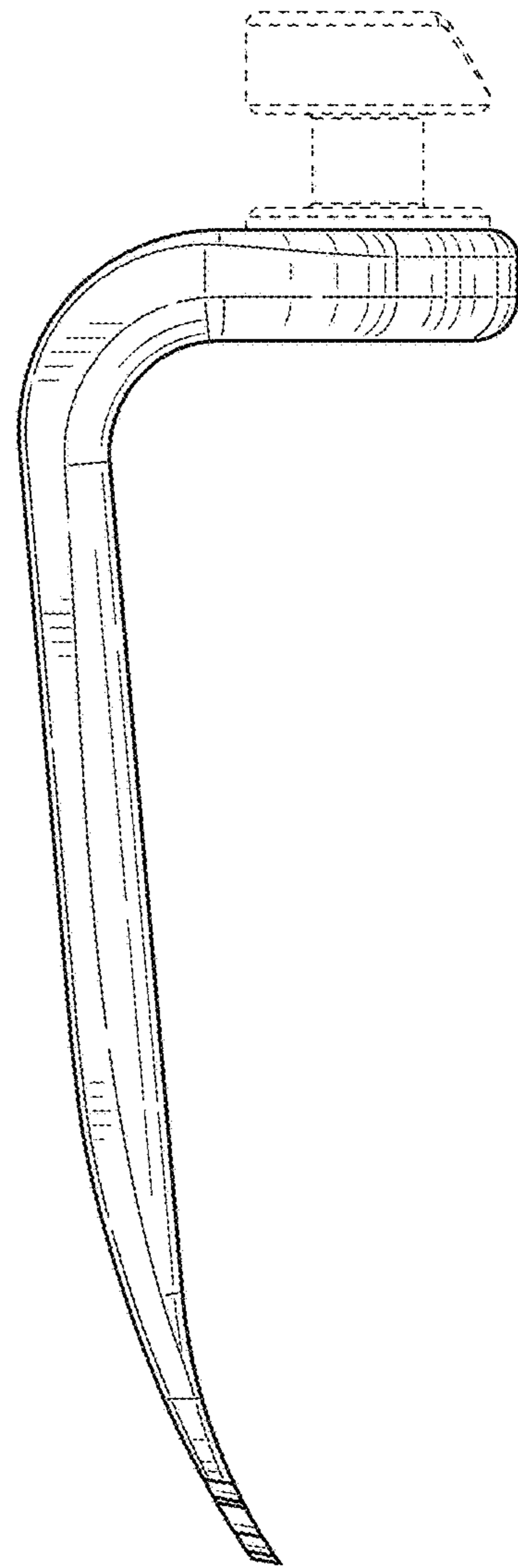

FIG. 6

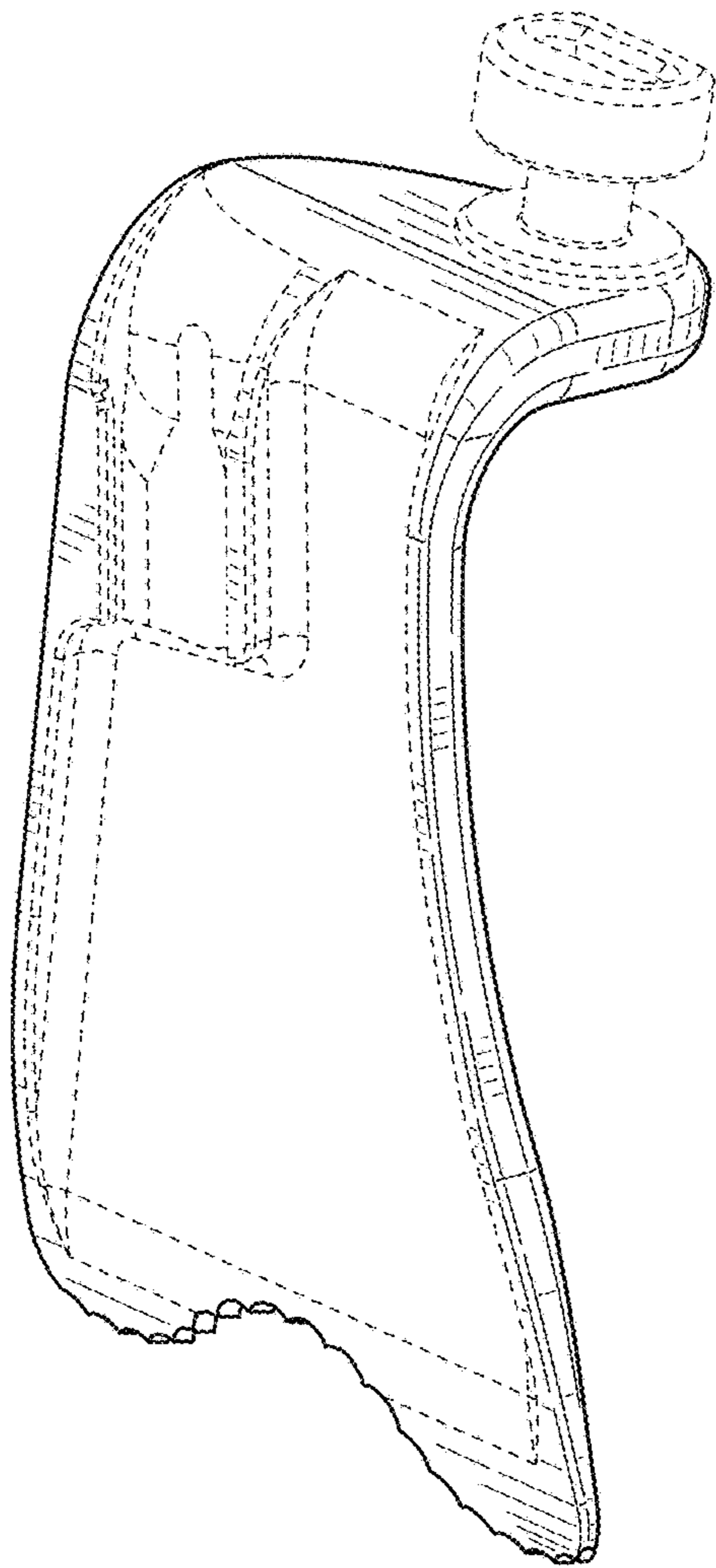

FIG. 7

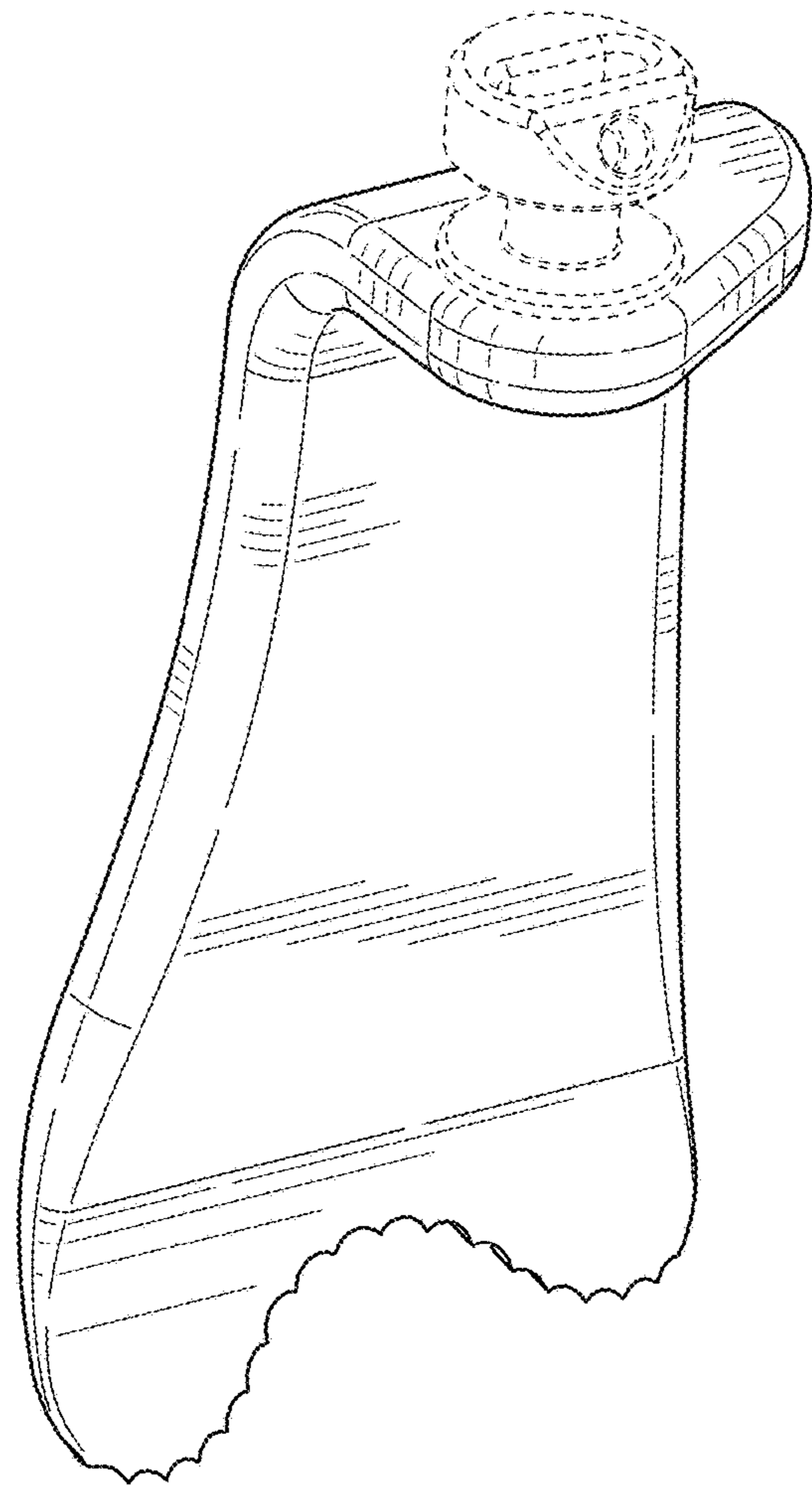

FIG. 8

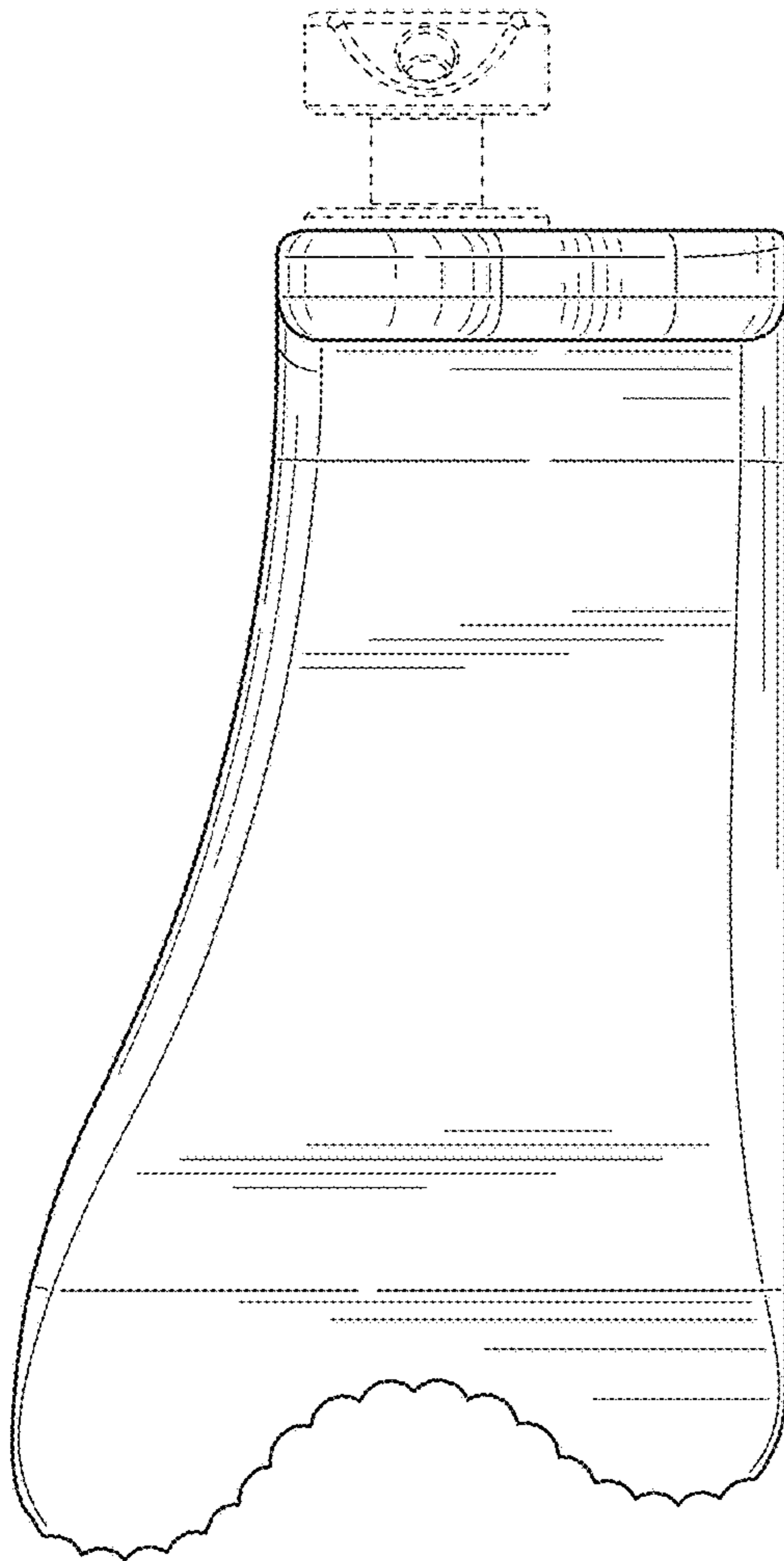

FIG. 9

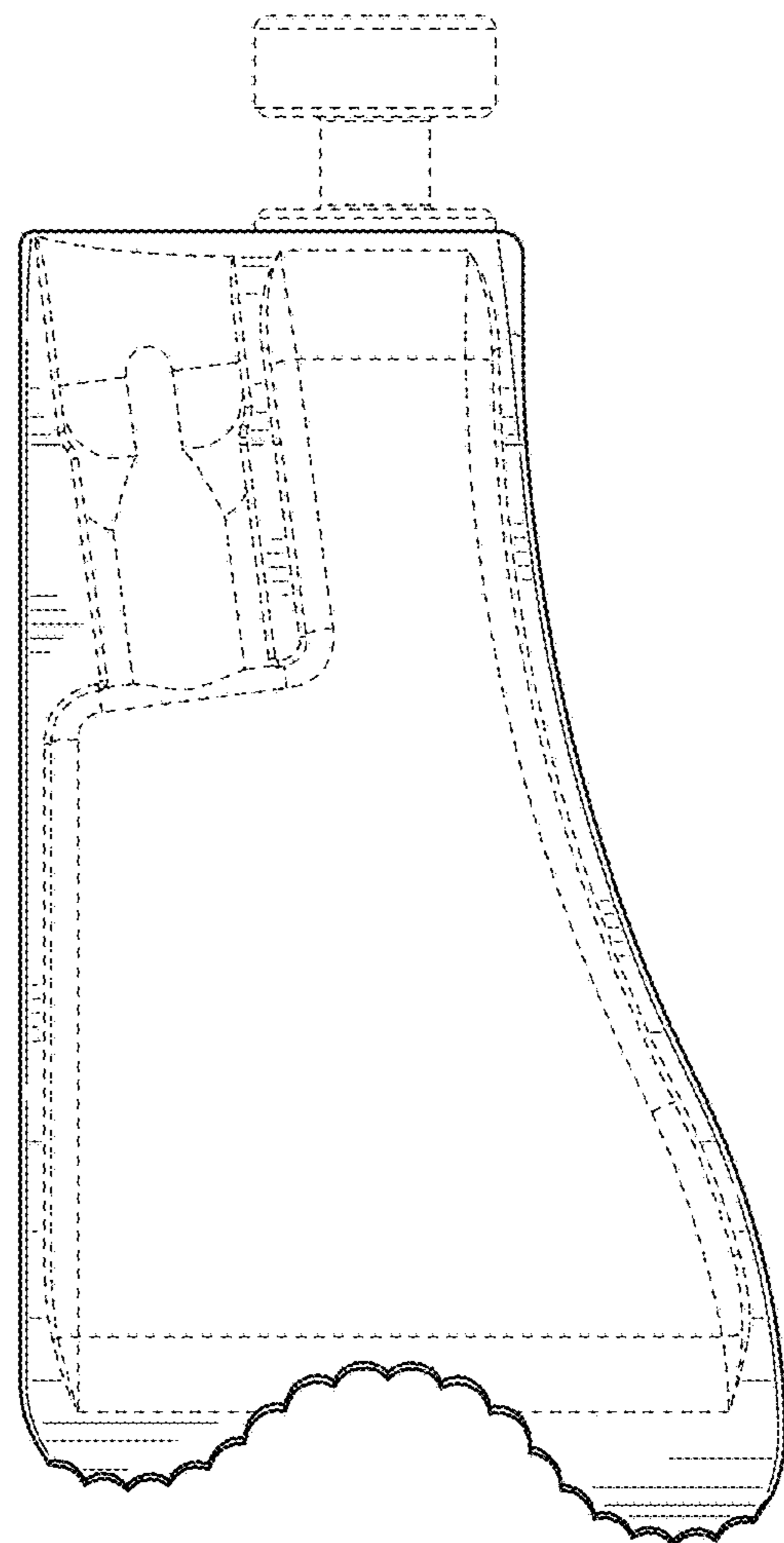

FIG. 10



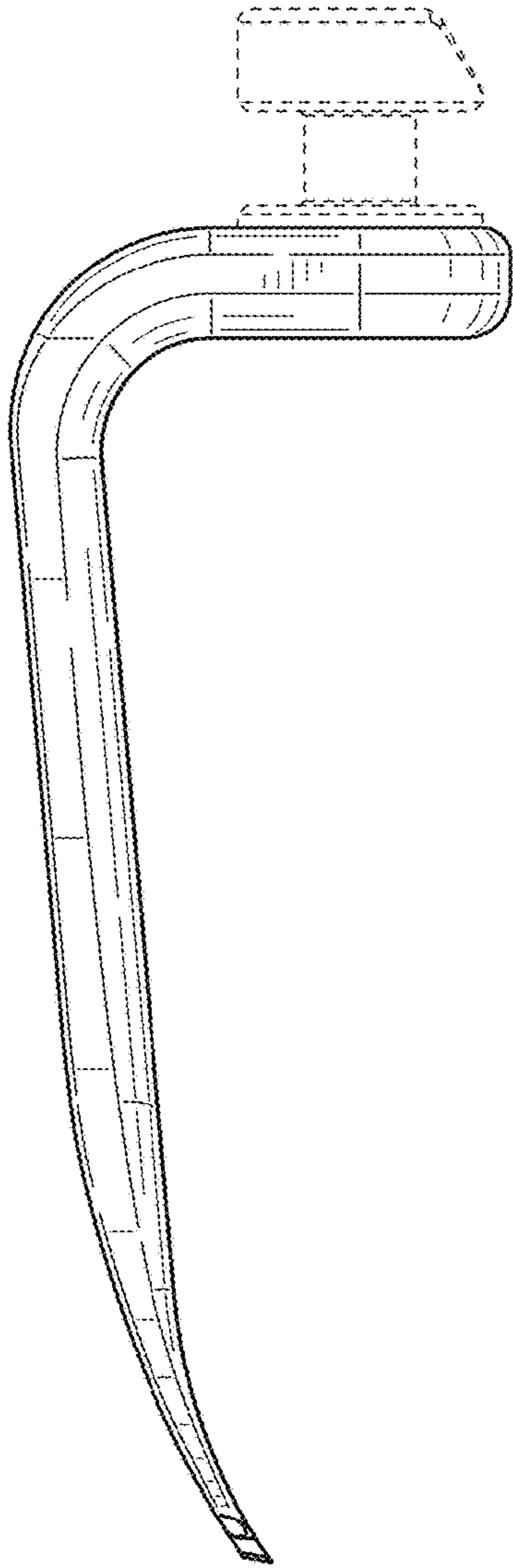

FIG. 11

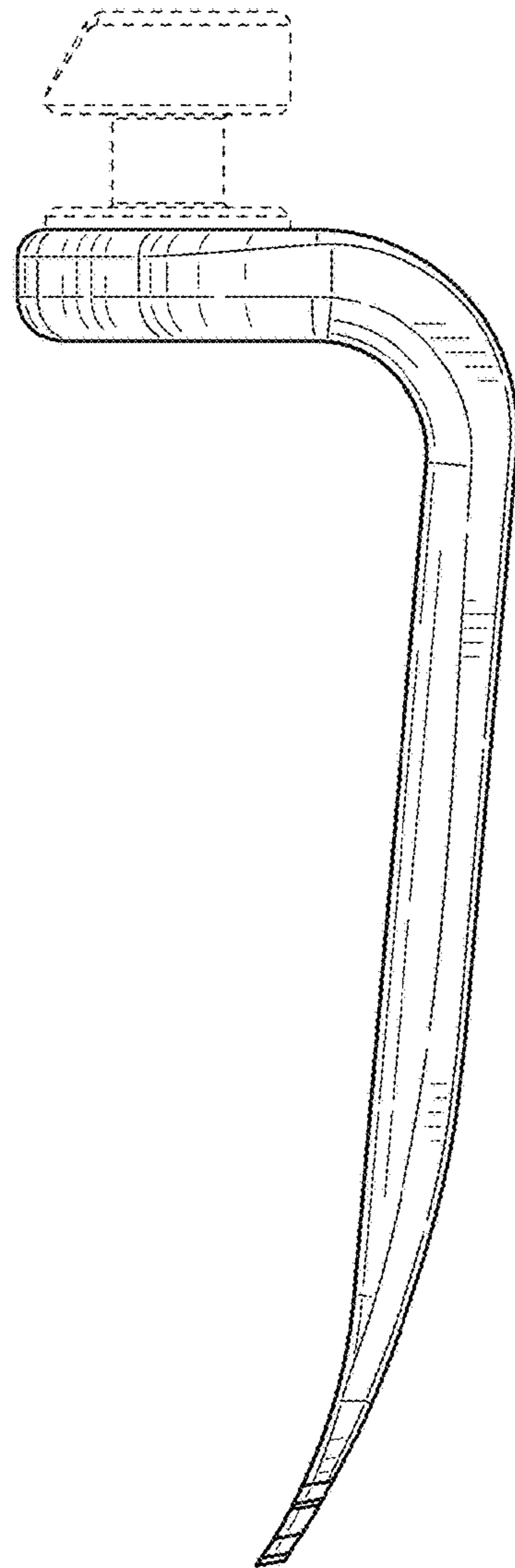

FIG. 12