



US00D789522S

(12) **United States Design Patent** (10) **Patent No.:** **US D789,522 S**
Burgess et al. (45) **Date of Patent:** **** Jun. 13, 2017**

- | | |
|--|--|
| (54) FLUID COLLECTION CONTAINER LID | 4,642,089 A 2/1987 Zupkas et al.
4,664,652 A 5/1987 Weilbacher
4,681,571 A 7/1987 Nehring
4,736,859 A 4/1988 Mayes et al.
4,737,139 A 4/1988 Zupkas et al.
D297,046 S * 8/1988 Dignam D24/112
4,796,757 A 1/1989 Strunkmann-Meister
4,846,800 A 7/1989 Ouriel et al.
4,880,411 A 11/1989 Fangrow et al.
4,909,780 A 3/1990 Ouriel et al.
4,953,728 A 9/1990 Meek |
| (71) Applicant: Medline Industries, Inc. , Mundelein, IL (US) | |
| (72) Inventors: James E. Burgess , Mundelein, IL (US);
John Kutsch , Harvard, IL (US) | |
| (73) Assignee: Medline Industries, Inc. , Northfield, IL (US) | |

(Continued)

(**) Term: **14 Years**

(21) Appl. No.: **29/486,678**

(22) Filed: **Apr. 1, 2014**

Related U.S. Application Data

- (63) Continuation of application No. 29/465,688, filed on Aug. 30, 2013, now Pat. No. Des. 705,926.
- (51) **LOC (10) Cl.** **24-02**
- (52) **U.S. Cl.**
USPC **D24/121**
- (58) **Field of Classification Search**
USPC D24/121, 123, 224, 122; 210/435, 130, 210/136, 248, 339, 448, 452; 604/317-325
CPC A61M 1/0001; A61M 1/0052
See application file for complete search history.

(56) **References Cited**

U.S. PATENT DOCUMENTS

- | | | | |
|--------------|---------|-------------------|---------|
| 3,701,456 A | 10/1972 | Alroy et al. | |
| D235,192 S * | 5/1975 | Olsen | D13/119 |
| 4,013,076 A | 3/1977 | Puderbaugh et al. | |
| 4,228,798 A | 10/1980 | Deaton | |
| 4,347,946 A | 9/1982 | Nichols | |
| 4,430,084 A | 2/1984 | Deaton | |
| 4,460,361 A | 7/1984 | Nichols | |
| 4,487,606 A | 12/1984 | Leviton et al. | |
| D288,129 S | 2/1987 | Taylor | |

OTHER PUBLICATIONS

Various Manufacturers, "Canisters and Lids from Allied, Ortho", Unknown manufacturing date, but prior to the filing of the present application.

(Continued)

Primary Examiner — David Muller

(74) *Attorney, Agent, or Firm* — Philip H. Burrus, IV

(57) **CLAIM**

The ornamental design for a fluid collection container lid, as shown and described.

DESCRIPTION

FIG. 1 is top perspective view of a fluid collection container lid, illustrating our new design;
 FIG. 2 is a bottom perspective view thereof;
 FIG. 3 is a top plan view thereof;
 FIG. 4 is a bottom plan view thereof;
 FIG. 5 is a left side elevation view thereof;
 FIG. 6 is a right side elevation view thereof;
 FIG. 7 is a rear elevation view thereof; and,
 FIG. 8 is a front elevation view thereof.

The broken line showing parts of the drawings is included for the purpose of illustrating use and environment and forms no part of the claimed design.

1 Claim, 4 Drawing Sheets

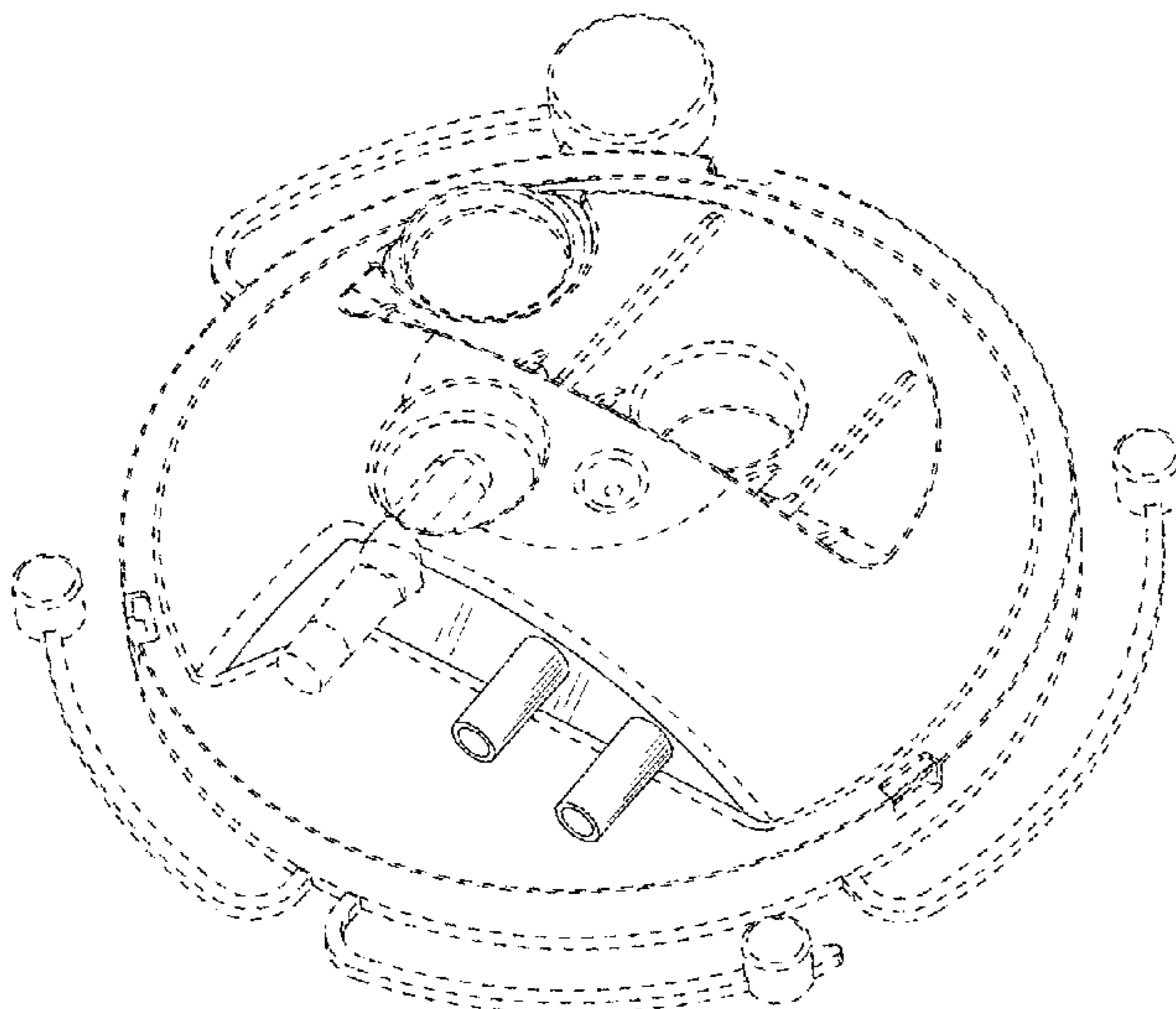

(56)

References Cited

U.S. PATENT DOCUMENTS

5,049,273	A	9/1991	Knox	
D322,124	S	12/1991	Lichte et al.	
5,158,533	A	10/1992	Strauss et al.	
D335,535	S *	5/1993	Arioka	D24/112
5,219,185	A *	6/1993	Oddenino	F16L 37/088 285/187
5,254,080	A	10/1993	Lindsay	
D350,823	S *	9/1994	Lanigan	D24/111
D365,146	S *	12/1995	Olson	D24/108
D367,928	S *	3/1996	Pharaoh	D24/109
D369,664	S *	5/1996	Dye	D23/260
D370,263	S	5/1996	Falkenberg et al.	
D372,102	S	7/1996	Peacock et al.	
5,637,104	A	6/1997	Ball et al.	
5,665,080	A	9/1997	Vandenberg	
D387,157	S *	12/1997	Cotter	D24/108
5,792,126	A	8/1998	Tribastone et al.	
5,871,476	A	2/1999	Hand	
D409,748	S *	5/1999	Lanigan	D24/127
5,944,703	A	8/1999	Dixon et al.	
5,960,837	A	10/1999	Cude	
D418,916	S *	1/2000	Bastable	D24/108
6,139,738	A	10/2000	Maxwell	
D435,906	S	1/2001	Wilkinson et al.	
6,358,232	B1	3/2002	Hand	
6,409,220	B1	6/2002	Wing et al.	
6,494,869	B1	12/2002	Hand et al.	
6,575,946	B2	6/2003	Sealfon	
6,626,877	B2	9/2003	Anderson et al.	
D522,145	S	5/2006	Best et al.	
D536,783	S *	2/2007	Cise	D24/111
7,329,250	B2	2/2008	Romano	
D574,488	S	8/2008	Chauvin	
7,481,243	B2	1/2009	Michaels et al.	
7,497,340	B2	3/2009	Hershberger et al.	
7,712,360	B2 *	5/2010	Jones	A61M 1/0023 604/317
7,806,879	B2	10/2010	Brooks et al.	
7,841,243	B1	11/2010	Feller	
7,854,729	B2	12/2010	Romano et al.	
7,955,318	B1	6/2011	Schultz	
D644,317	S	8/2011	Tsao	
8,118,795	B2	2/2012	Romano et al.	
8,172,832	B1	5/2012	Gonzalez	
D678,502	S	3/2013	Schmidt et al.	
2005/0189288	A1	9/2005	Hershberger et al.	
2006/0081642	A1	4/2006	Taylor	
2008/0015526	A1	1/2008	Reiner et al.	
2009/0045209	A1	2/2009	Taylor	

OTHER PUBLICATIONS

Muller, David “Non-Final Office Action”, U.S. Appl. No. 29/360,679, filed Apr. 29, 2010, James E. Burgess, first inventor, Mailed Jun. 9, 2010.

Muller, David G., “Restriction Requirement”, U.S. Appl. No. 29/360,669, filed Apr. 29, 2010, Mailed Nov. 1, 2010.

Muller, David G., “Final Office Action”, U.S. Appl. No. 29/360,679, filed Apr. 29, 2010, Mailed Nov. 10, 2010, minor issues with drawings (to be corrected).

Muller, David G., “Non-Final Office Action”, U.S. Appl. No. 29/360,669, filed Apr. 29, 2010, Mailed Nov. 9, 2010, minor changes to drawings required.

Muller, David G., “Ex Parte Quayle Action”, U.S. Appl. No. 29/360,669, filed Apr. 29, 2010, Mailed Feb. 1, 2011.

Muller, David G., “Ex Parte Quayle Action”, U.S. Appl. No. 29/360,679, filed Apr. 29, 2010, Mailed Feb. 1, 2011.

Muller, David G., “NonFinal OA”, U.S. Appl. No. 29/393,814, filed Jun. 9, 2011; Mailed Aug. 13, 2012.

Edwards, Brett J., “NonFinal Office Action”, U.S. Appl. No. 12/769,900, filed Apr. 29, 2010; Mailed Sep. 18, 2012.

Muller, David G., “Notice of Allowance”, U.S. Appl. No. 29/393,814, filed Jun. 9, 2011; Mailed Dec. 3, 2012.

Edwards, Brett J., “Final OA”, U.S. Appl. No. 12/769,900, filed Apr. 29, 2010; Mailed May 6, 2013.

Muller, David G., “Notice of Allowance”, U.S. Appl. No. 29/448,489, filed Mar. 12, 2013; Mailed May 30, 2013.

Edwards, Brett “NonFinal OA”, U.S. Appl. No. 12/769,900, filed Apr. 29, 2010; Mailed Oct. 2, 2013.

Muller, David G., “Notice of Allowance”, U.S. Appl. No. 29/465,688, filed Aug. 30, 2013; Mailed Dec. 19, 2013.

“Office Action Mexican Patent Office”, MX/a/2010/013684; Filed Dec. 10, 2010; Mailed Dec. 10, 2013.

Muller, David “Non-Final Office Action”, U.S. Appl. No. 29/360,679, filed Apr. 29, 2010, James E. Burgess, first inventor, Art Unit 2914, Mailed Jun. 9, 2010.

Muller, David G., “Ex Parte Quayle Action”, U.S. Appl. No. 29/360,669, filed Apr.29, 2010, Mailed Feb. 1, 2011.

“Second Office Action”, Mx/a/2010/013684; Filed Dec. 10, 2010; Ref 10P0738; Mailed Apr. 15, 2014.

Chandra, Chetan G., “Final OA”, U.S. Appl. No. 12/769,900, filed Apr. 29, 2010; Mailed May 5, 2014.

Chandra, Chetan G., “NonFinal OA”, U.S. Appl. No. 12/769,900, filed Apr. 29, 2010; Mailed Sep. 18, 2014.

“Final Office Action”, Application No. Mx/a/2010/013684; Filed Dec. 10, 2010; Mailed Sep. 19, 2014.

Chandra, Chetan G., “Final OA”, U.S. Appl. No. 12/769,900, filed Apr. 29, 2010; Mailed Mar. 25, 2015.

Chandra, Chetan Gattu “Final OA”, U.S. Appl. No. 12/769,900, filed Apr. 29, 2010; Mailed Mar. 25, 2015.

Rashid, Ishtiaque “NonFinal OA”, Canadian App No. 2,706,157; Reference No. 15468-P37240CA00; Mailed Mar. 22, 2016.

Avila, Jose Enrique “NonFinal OA”, Mexican Patent Application No.Mx/a/2013/011738; Mailed Apr. 12, 2016.

Avila, Jose Enrique “Office Action”, Mexican Application No.Mx/a/2013/011739; Mailed Apr. 13, 2016.

“Medline Catalog”, 800cc Disposable Suction Canister by Drive Medical; Medline Catalog; <http://www.medline.com/catalog/catalog.jsp>; Unknown Publication date but believed to be prior to present application filing date.

“Medline Catalog”, Aspirator Canisters by Precision Medical; Medline Catalog; <http://www.medline.com/catalog/catalog.jsp>; Unknown Publication date but believed to be prior to present application filing date.

“Medline Catalog”, Berkeley Large Collection Canisters by Circon/Gyrans.Acmi; Medline Catalog; <http://www.medline.com/catalog/catalog.jsp>; Unknown Publication date but believed to be prior to present application filing date.

“Medline Catalog”, Canister Semi Rigid 1000CC w/1 Elbow; Medline Catalog; <http://www.medline.com/catalog/catalog.jsp>; Unknown Publication date but believed to be prior to present application filing date.

“Medline Catalog”, Crystalline Rigid Canister System by DeRoyal; Medline Catalog; <http://www.medline.com/catalog/catalog.jsp>; Unknown Publication date but believed to be prior to present application filing date.

“Medline Catalog”, Disposable Suction Canisters and Kits with Float Lids; Medline Catalog; <http://www.medline.com/catalog/catalog.jsp>; Unknown Publication date but believed to be prior to present application filing date.

“Medline Catalog”, Flex Advantage Suction Liners by Cardinal Health; Medline Catalog; <http://www.medline.com/catalog/catalog.jsp>; Unknown Publication date but believed to be prior to present application filing date.

“Medline Catalog”, Guardian Suction Canisters by Cardinal Health; Medline Catalog; <http://www.medline.com/catalog/catalog.jsp>; Unknown Publication date but believed to be prior to present application filing date.

“Medline Catalog”, Rigid Disposable Suction Canisters with Stem Lid; Medline Catalog; <http://www.medline.com/catalog/catalog.jsp>; Unknown Publication date but believed to be prior to present application filing date.

“Medline Catalog”, Rigid Suction Canisters; Medline Catalog; <http://www.medline.com/catalog/catalog.jsp>; Unknown Publication date but believed to be prior to present application filing date.

(56)

References Cited

OTHER PUBLICATIONS

“Medline Catalog”, Semi-Rigid Canisters by DeRoyal; Medline Catalog; <http://www.medline.com/catalog/catalog.jsp>; Unknown Publication date but believed to be prior to present application filing date.

“Medline Catalog”, Suction Canisters by Cardinal Brands; Medline Catalog; <http://www.medline.com/catalog/catalog.jsp>; Unknown Publication date but believed to be prior to present application filing date.

“Medline Catalog”, Suction Canisters by Jedmed; Medline Catalog; <http://www.medline.com/catalog/catalog.jsp>; Unknown Publication date but believed to be prior to present application filing date.

“Medline Catalog”, Tandem Tubing by Cardinal Health; Medline Catalog; <http://www.medline.com/catalog/catalog.jsp>; Unknown Publication date but believed to be prior to present application filing date.

Rashid, Ishtiaque “Office Action”, Canadian Application No. 2,706,157; File No. 15486-P37240CA00; Mailed Nov. 2, 2016.

Avila, Jose Enrique Cazares “Office Action”, Mexican Application No.Mx/a/2013/011738; Filed Dec. 10, 2010; Mailed Nov. 11, 2016.

Avila, Jose Enrique Cazares “Office Action”, Mexican Application No.Mx/a/2013/011739; Filed Dec. 10, 2010; Mailed Nov. 11, 2016.

* cited by examiner

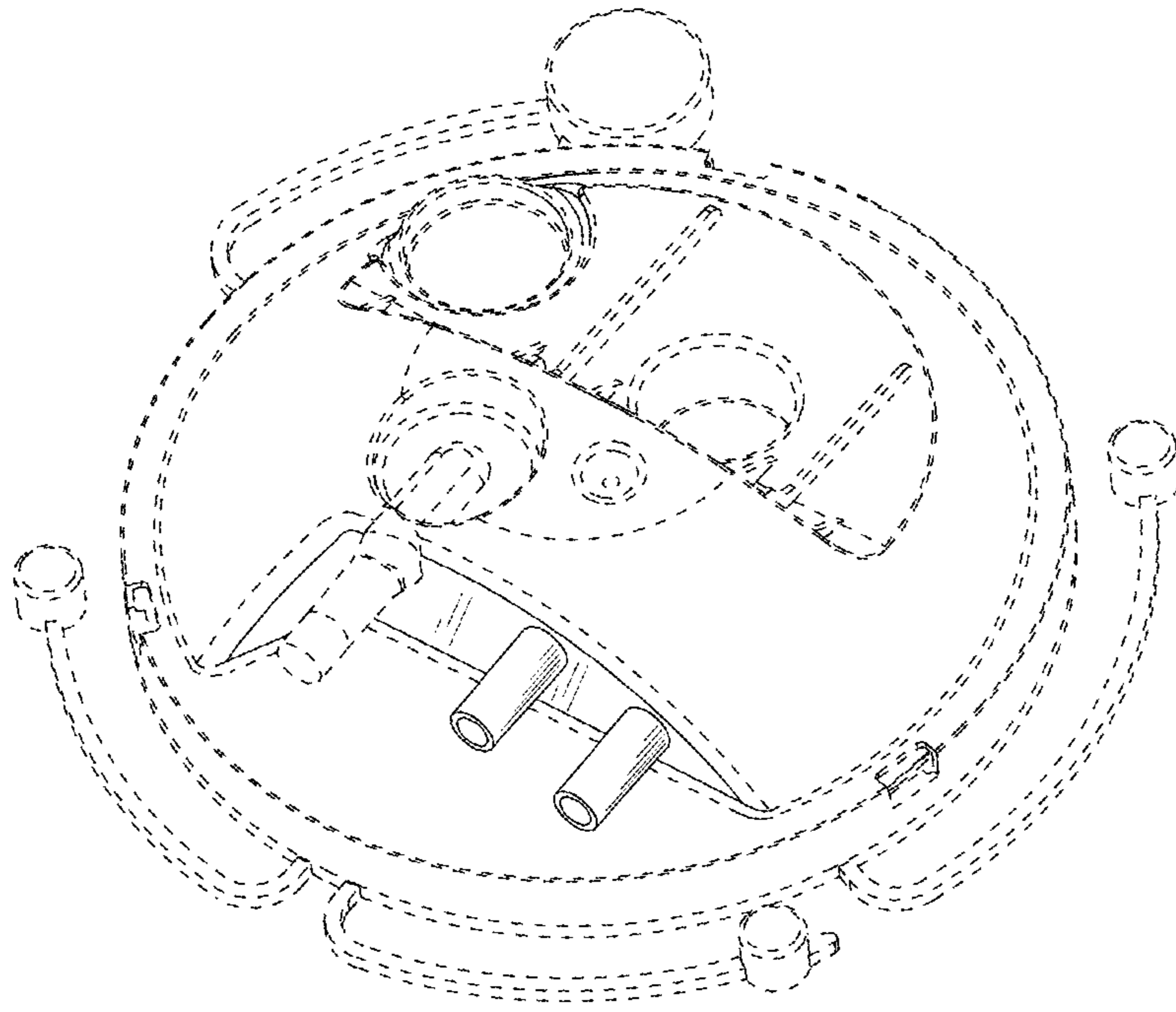

FIG. 1

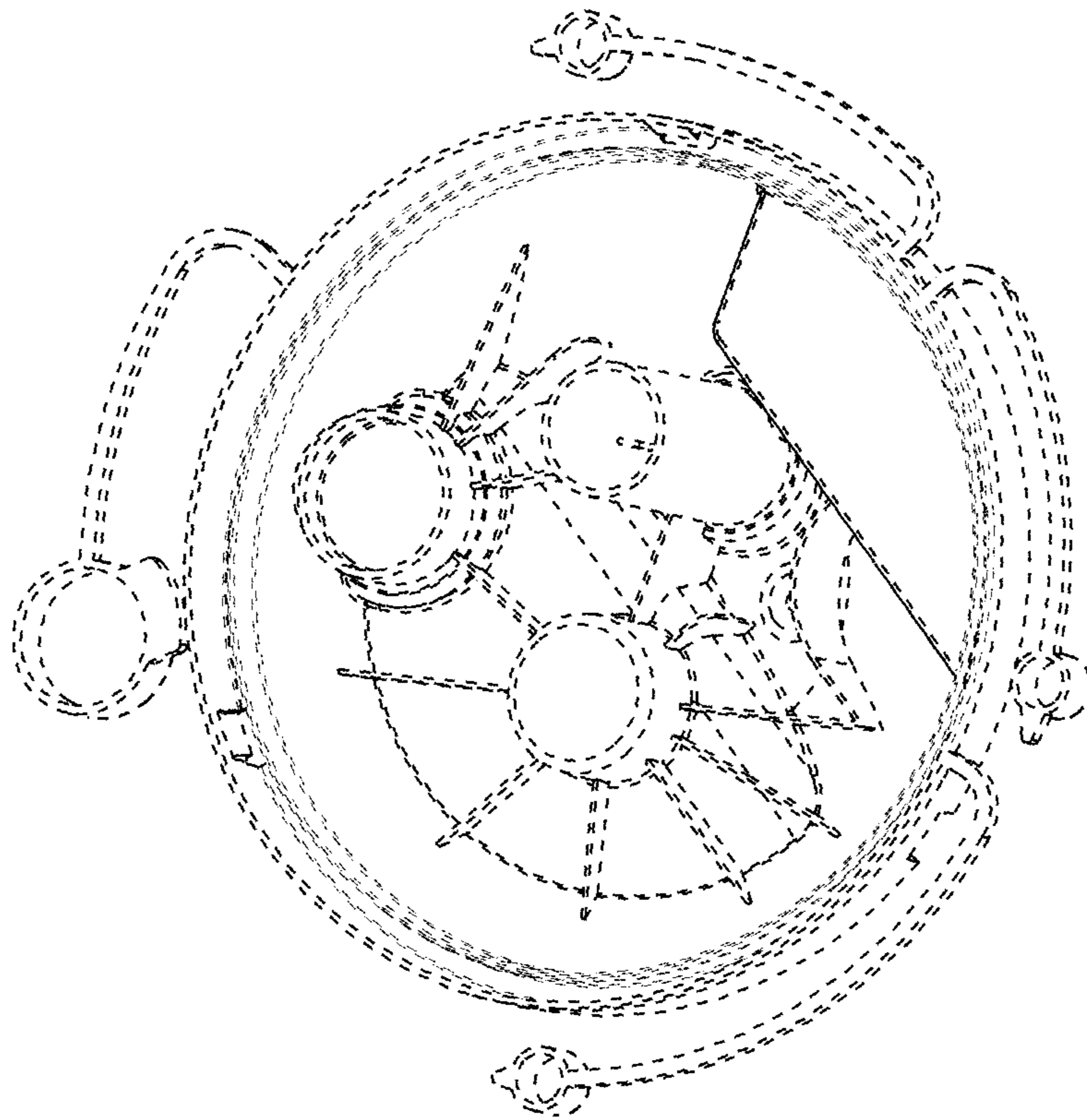

FIG. 2

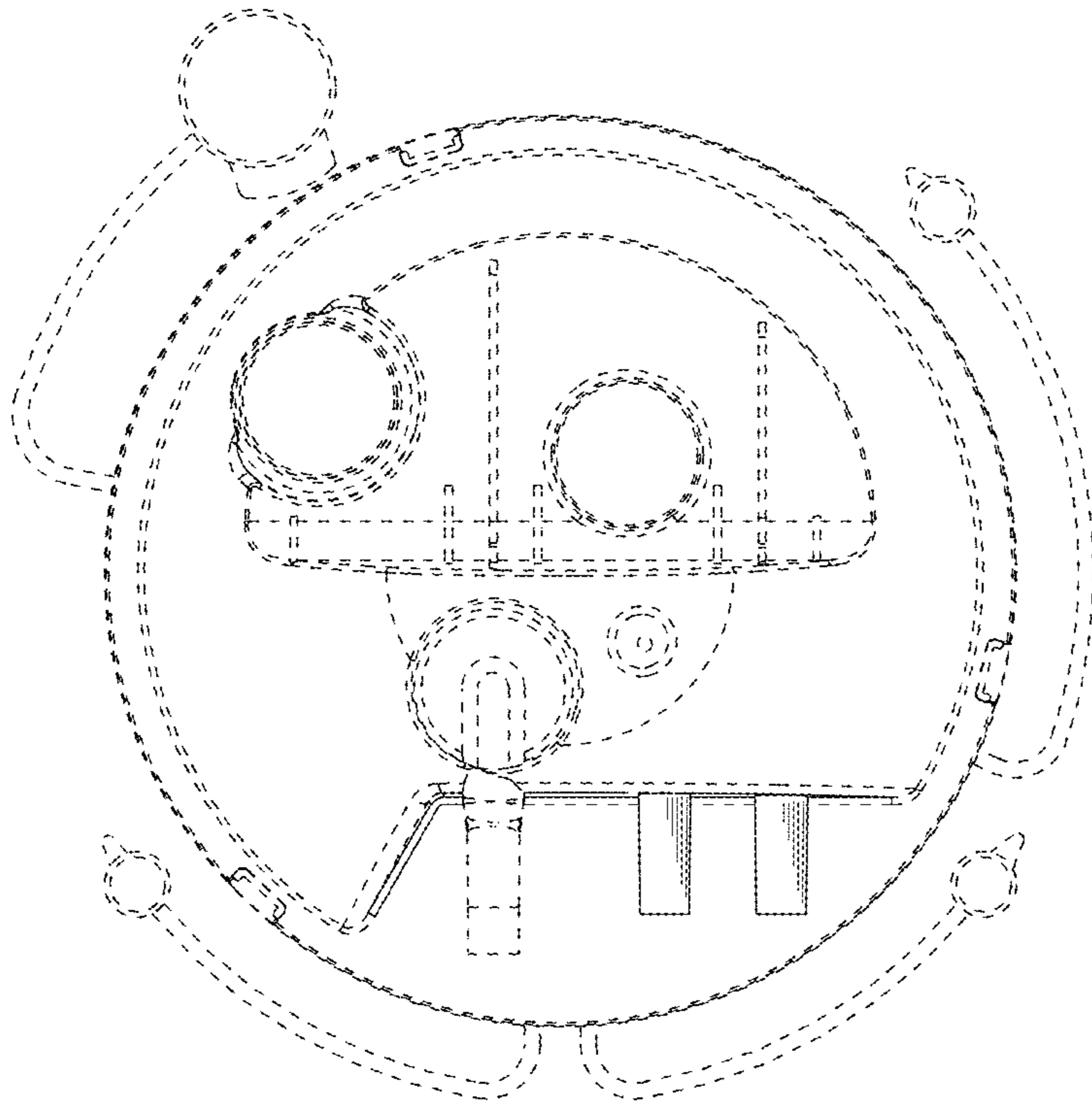

FIG. 3

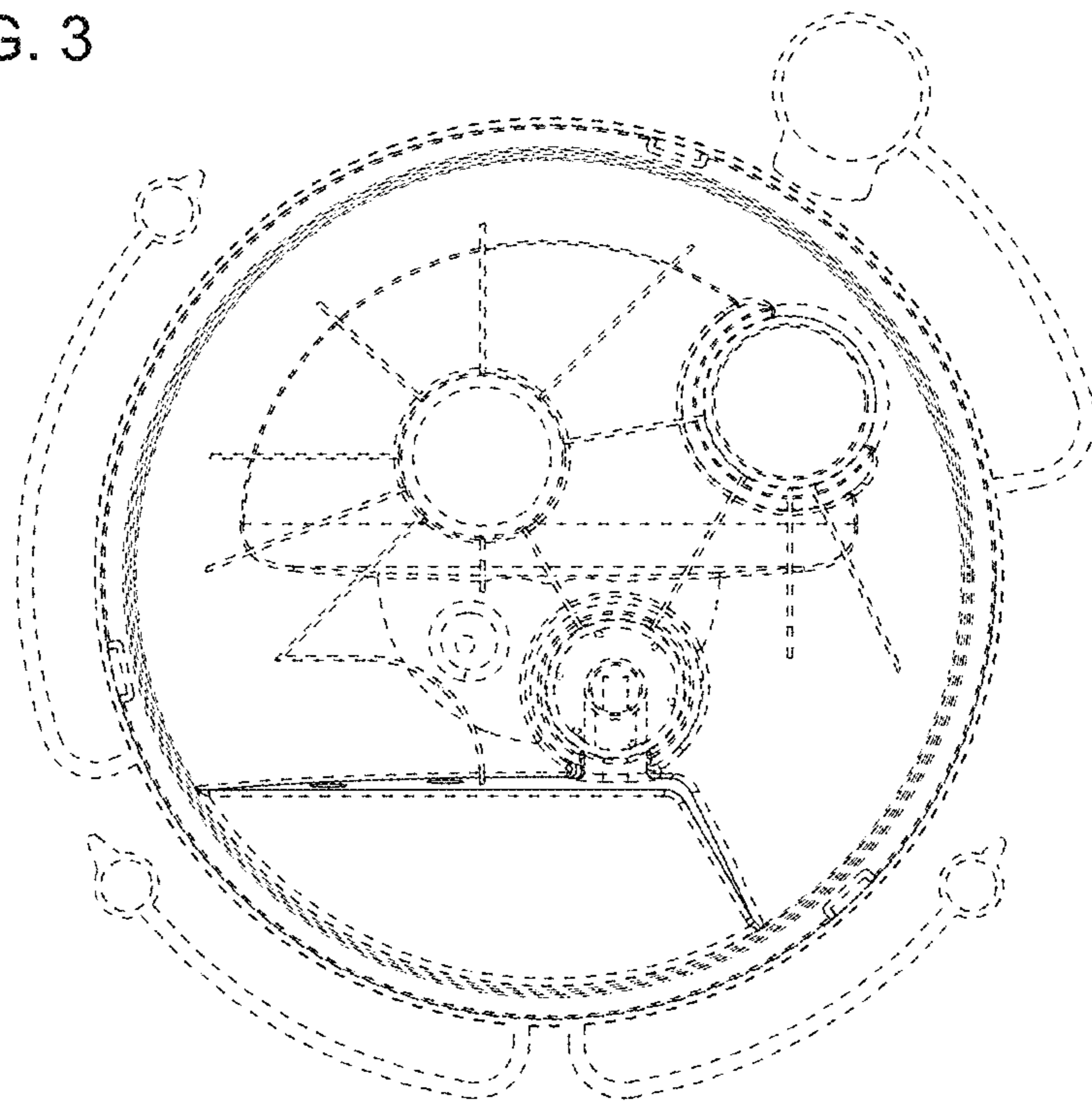

FIG. 4

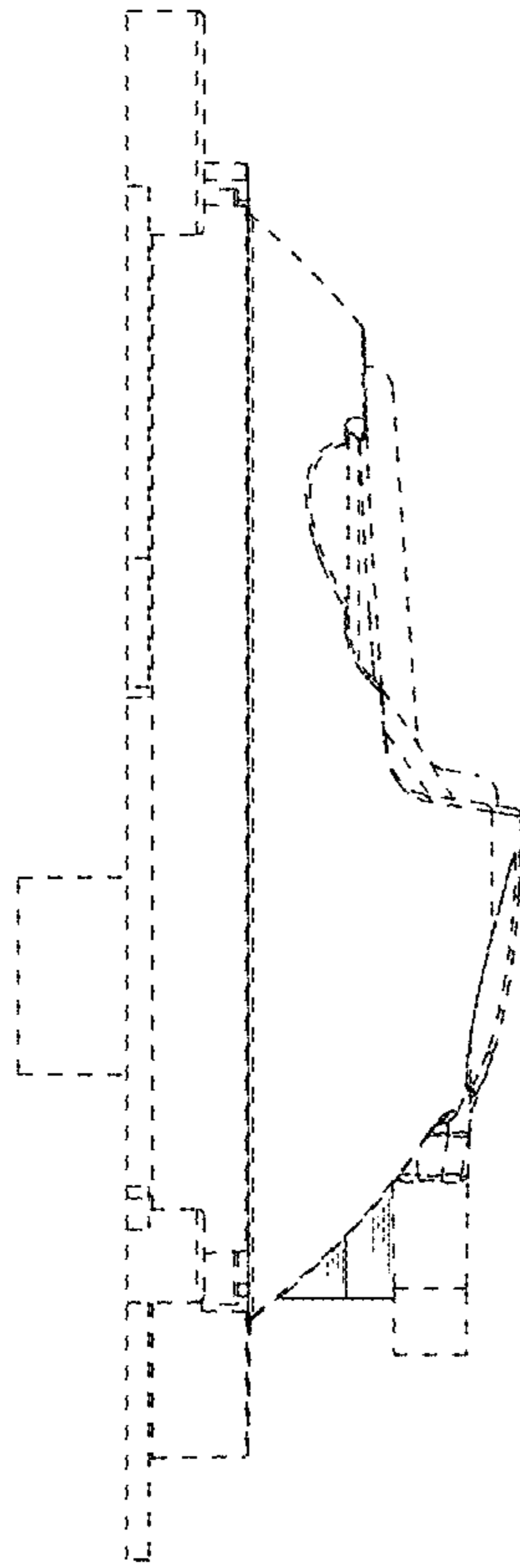

FIG. 5

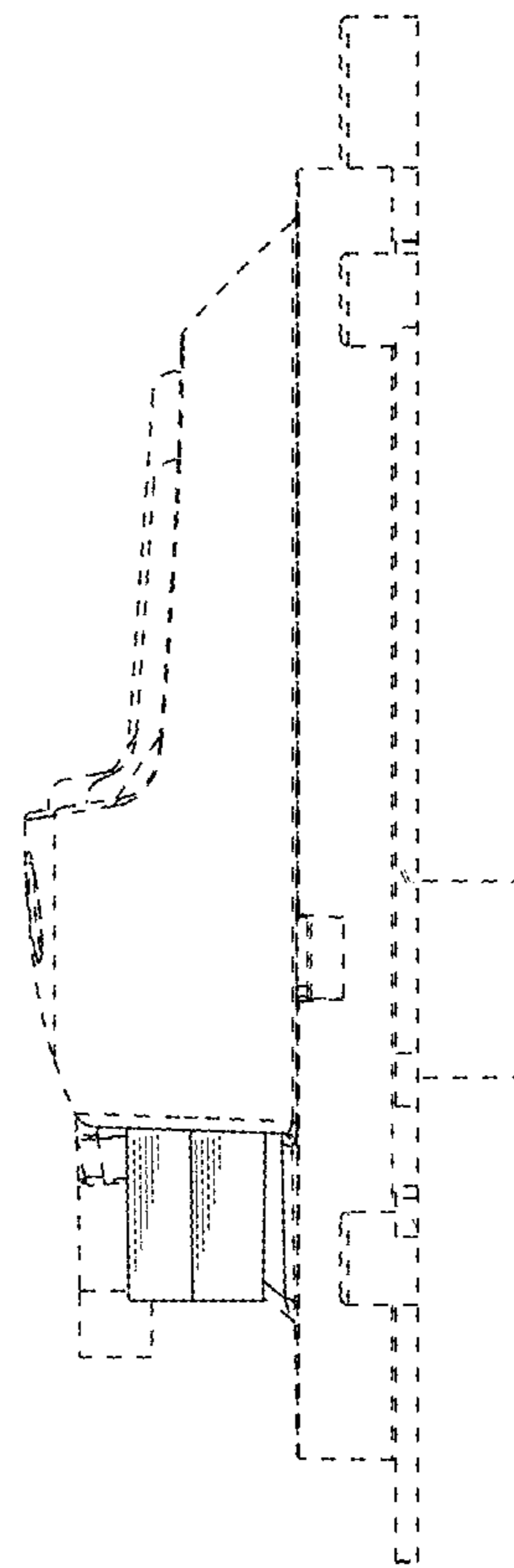

FIG. 6

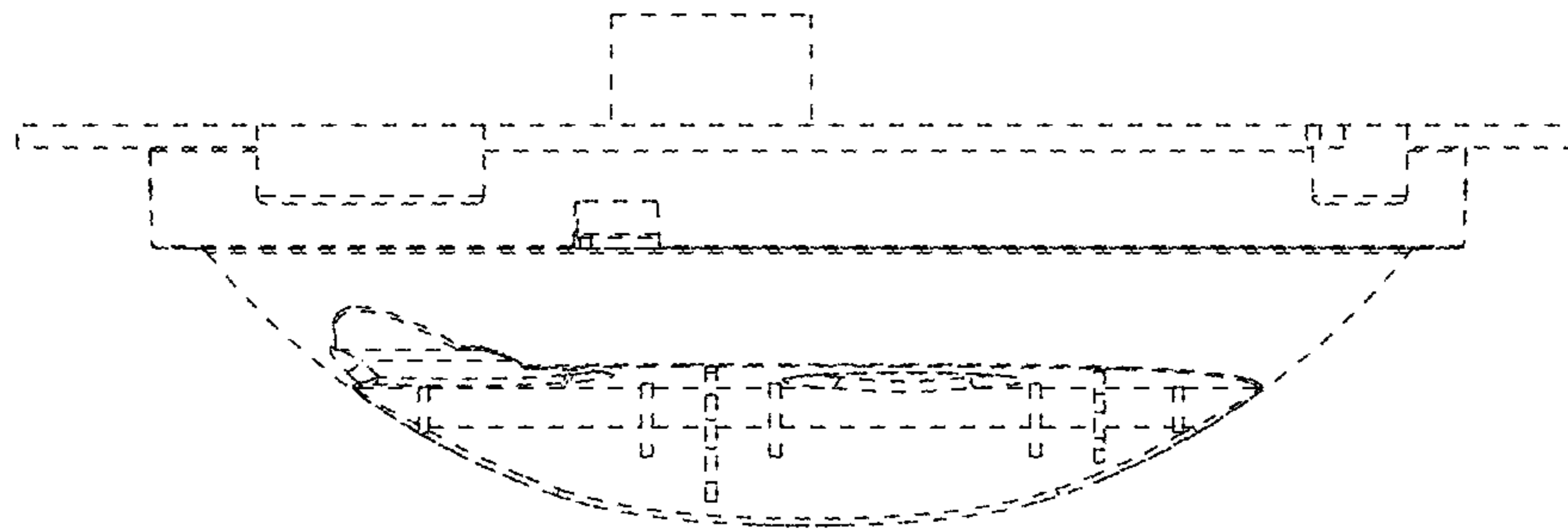

FIG. 7

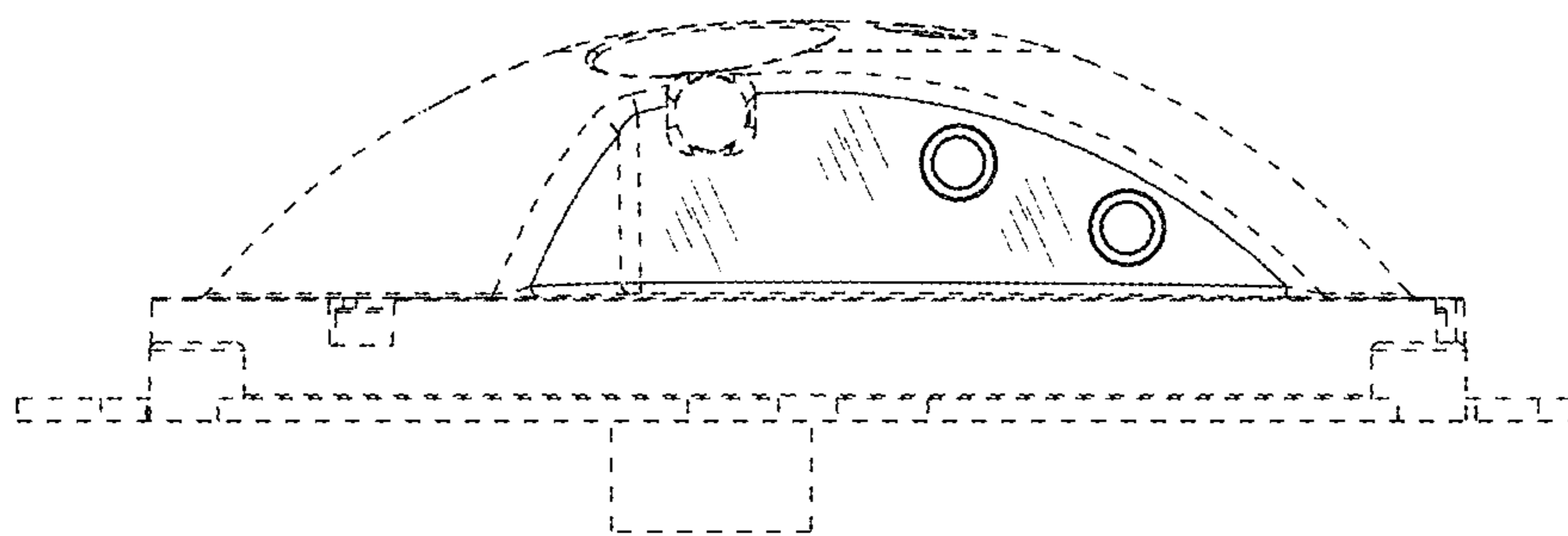

FIG. 8