



US00D789456S

(12) **United States Design Patent** (10) **Patent No.:** **US D789,456 S**
Frost et al. (45) **Date of Patent:** **** Jun. 13, 2017**

(54) **SET OF SQUARE DOMINO TILES**

(71) Applicants: **Wenlan H. Frost**, Houston, TX (US);
Daniel A. Frost, Sr., Houston, TX
(US); **Daniel A. Frost, Jr.**, Houston,
TX (US); **David H. Frost**, Houston, TX
(US)

(72) Inventors: **Wenlan H. Frost**, Houston, TX (US);
Daniel A. Frost, Sr., Houston, TX
(US); **Daniel A. Frost, Jr.**, Houston,
TX (US); **David H. Frost**, Houston, TX
(US)

(**) Term: **14 Years**

(21) Appl. No.: **29/517,465**

(22) Filed: **Feb. 12, 2015**

(51) **LOC (10) Cl.** **21-01**

(52) **U.S. Cl.**
USPC **D21/391**

(58) **Field of Classification Search**
USPC D21/386, 391, 397

(Continued)

(56) **References Cited**

U.S. PATENT DOCUMENTS

273,559 A * 3/1883 Lockwood A63F 1/02
273/293
405,164 A * 6/1889 Hyatt A63F 1/02
273/293

(Continued)

Primary Examiner — Darlington Ly

Assistant Examiner — Daniel J Domino

(57) **CLAIM**

The ornamental design for a set of square domino tiles, as shown and described.

DESCRIPTION

FIG. 1 is a top perspective view of a single square domino tile with one pip showing our new game piece design;

FIG. 2 is a top plan view thereof, the bottom being plain and unornamented;

FIG. 3 is a left side elevational view thereof, the right side being identical;

FIG. 4 is a front elevational view thereof, the rear being identical;

FIG. 5 is a top perspective view of a single square domino tile with two pips showing our new game piece design;

FIG. 6 is a top plan view thereof, the bottom being plain and unornamented;

FIG. 7 is a top perspective view of a single square domino tile with three pips showing our new game piece design;

FIG. 8 is a top plan view thereof, the bottom being plain and unornamented;

FIG. 9 is a top perspective view of a single square domino tile with four pips showing our new game piece design;

FIG. 10 is a top plan view thereof, the bottom being plain and unornamented;

FIG. 11 is a top perspective view of a single square domino tile with five pips showing our new game piece design;

FIG. 12 is a top plan view thereof, the bottom being plain and unornamented;

FIG. 13 is a top perspective view of a single square domino tile with six pips showing our new game piece design;

FIG. 14 is a top plan view thereof, the bottom being plain and unornamented;

FIG. 15 is a top perspective view of a single square domino tile with seven pips showing our new game piece design;

FIG. 16 is a top plan view thereof, the bottom being plain and unornamented;

FIG. 17 is a top perspective view of a single square domino tile with eight pips showing our new game piece design;

FIG. 18 is a top plan view thereof, the bottom being plain and unornamented;

FIG. 19 is a top perspective view of a single square domino tile with nine pips showing our new game piece design;

FIG. 20 is a top plan view thereof, the bottom being plain and unornamented; and,

FIG. 21 is a top plan view of the entire set.

The left side elevational views and the right side elevational views of all square domino tiles in FIG. 5 through FIG. 20 are identical to the tile illustrated in FIG. 3.

(Continued)

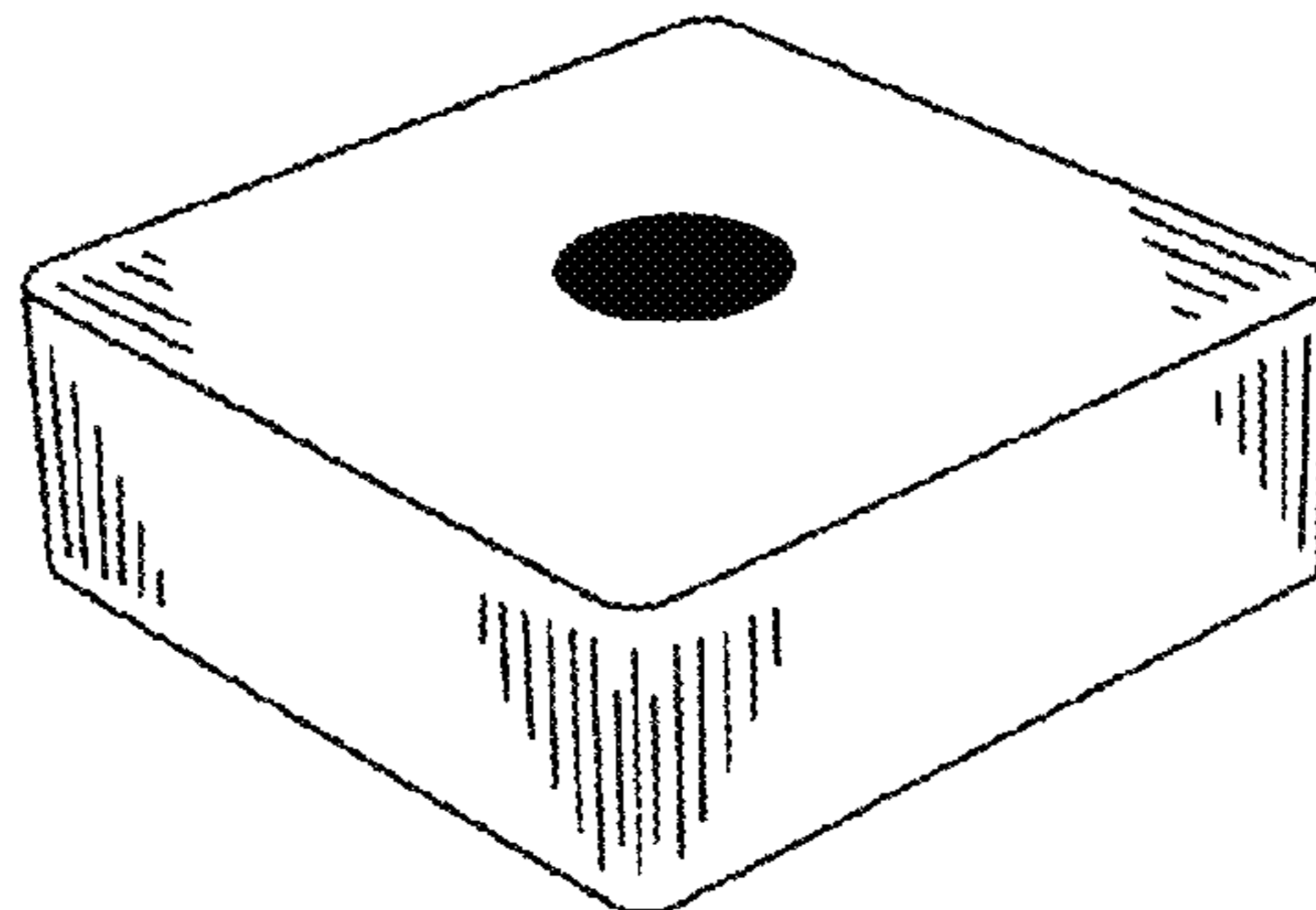

The front side elevational views and the rear side elevational views of all square domino tiles in FIG. 5 through FIG. 20 are identical to the tile illustrated in FIG. 4.

1 Claim, 10 Drawing Sheets

(58) Field of Classification Search

CPC A63F 9/10; A63F 9/20; A63F 9/34; A63F 1/00; A63F 1/02; A63F 1/06; A63F 1/18
See application file for complete search history.

(56) References Cited

U.S. PATENT DOCUMENTS

615,818 A * 12/1898 Dexter A63F 3/00157
273/292
1,998,526 A * 4/1935 Schubert A63F 9/20
273/292

4,468,037 A * 8/1984 Kuhn A63F 9/0613
273/295
5,478,085 A * 12/1995 Canner A63F 3/00694
273/239
D461,853 S * 8/2002 Cheng D21/391
6,871,855 B1 * 3/2005 Ko A63F 9/20
273/274
D542,859 S * 5/2007 Denoual D21/391
D559,918 S * 1/2008 Ramsey D21/391
D573,661 S * 7/2008 Golad D21/386
D589,568 S * 3/2009 Migdal D21/354
D624,131 S * 9/2010 Nathanson D21/391
7,832,732 B1 * 11/2010 Torres A63F 1/02
273/153 R
D662,149 S * 6/2012 Nathanson D21/391
D687,898 S * 8/2013 Lupkas D21/391
D739,895 S * 9/2015 Tellez D21/391
2005/0051954 A1 * 3/2005 Scott A63F 9/20
273/148 R

* cited by examiner

FIG. 1

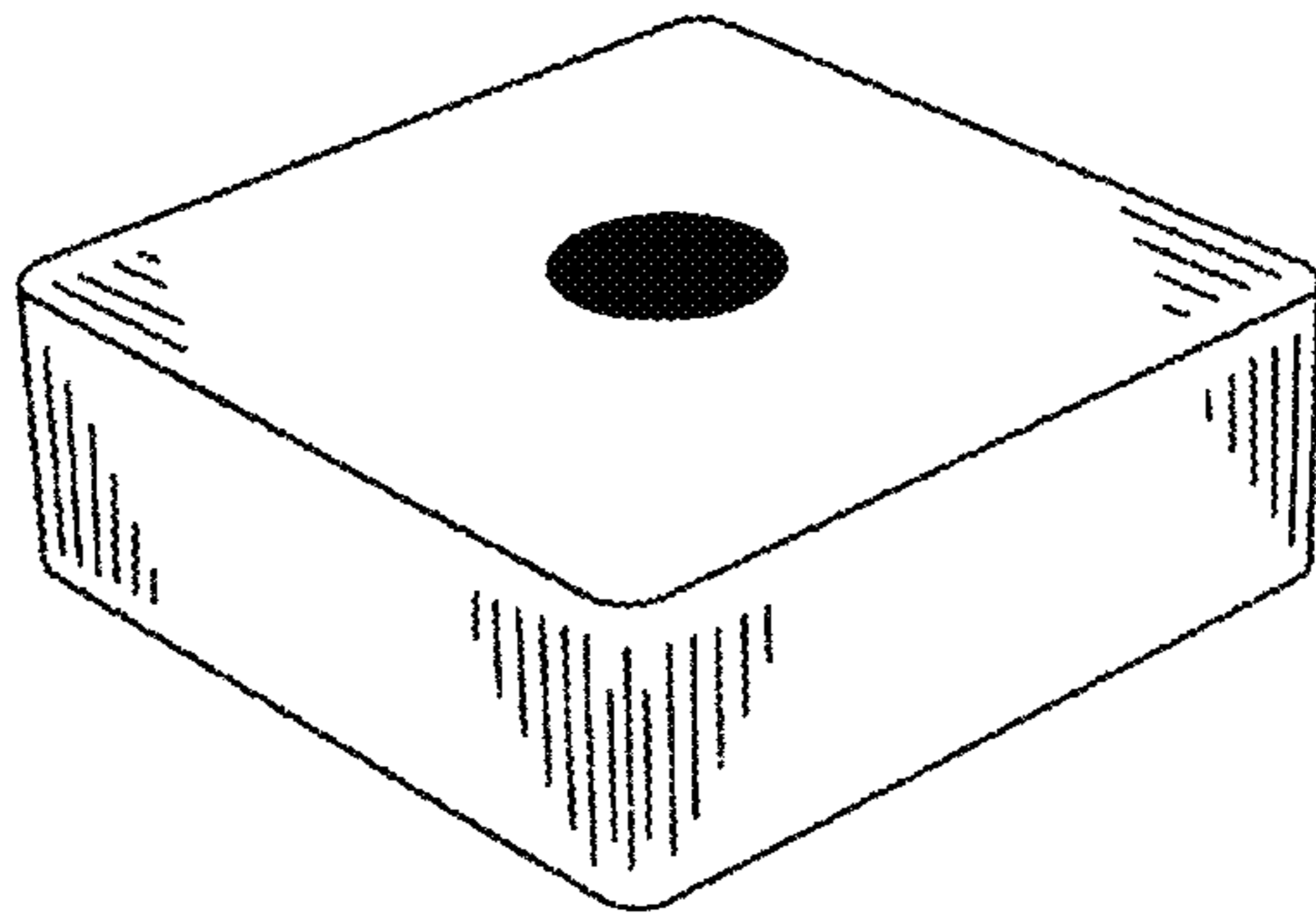

FIG. 2

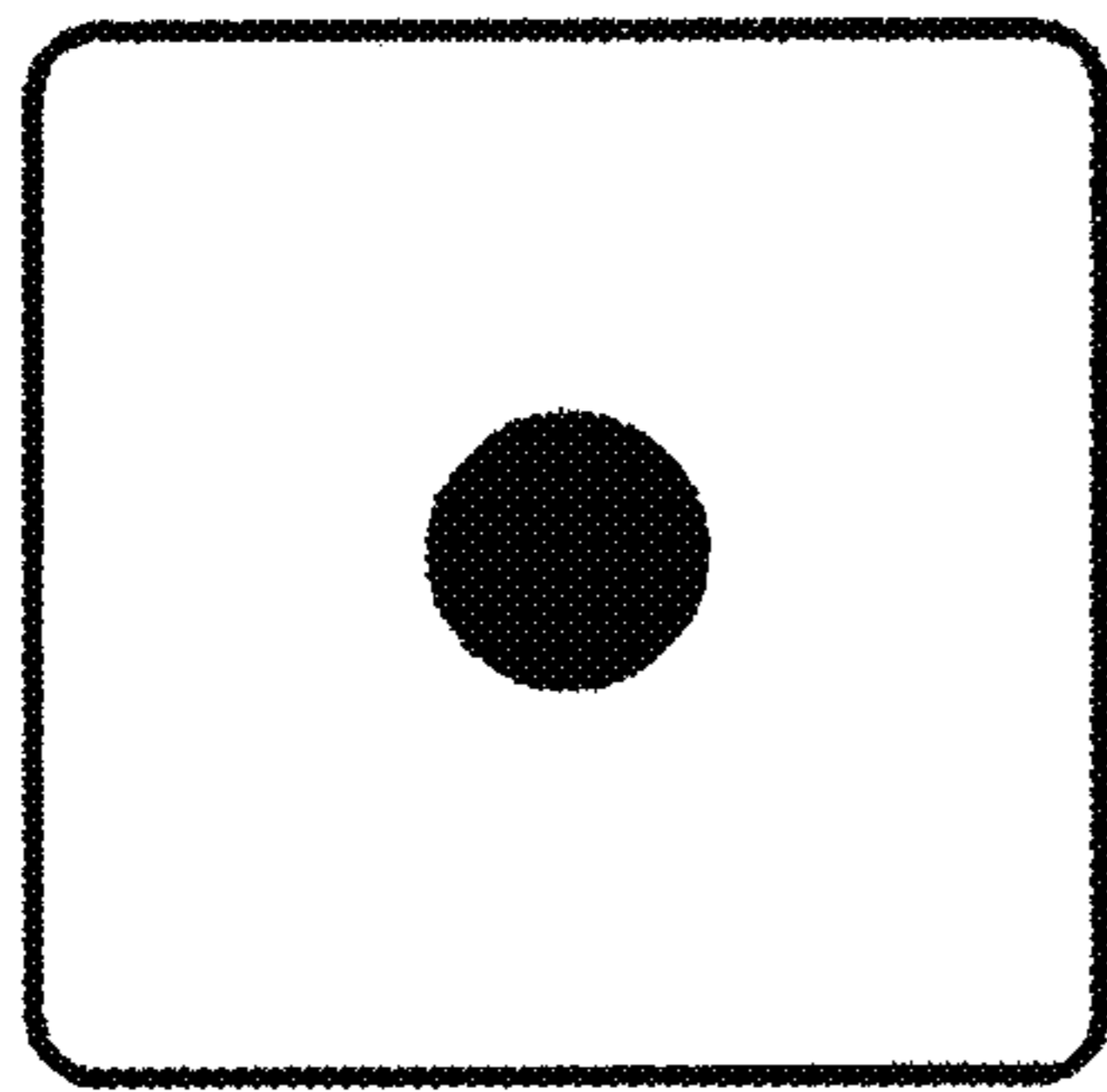

FIG. 3

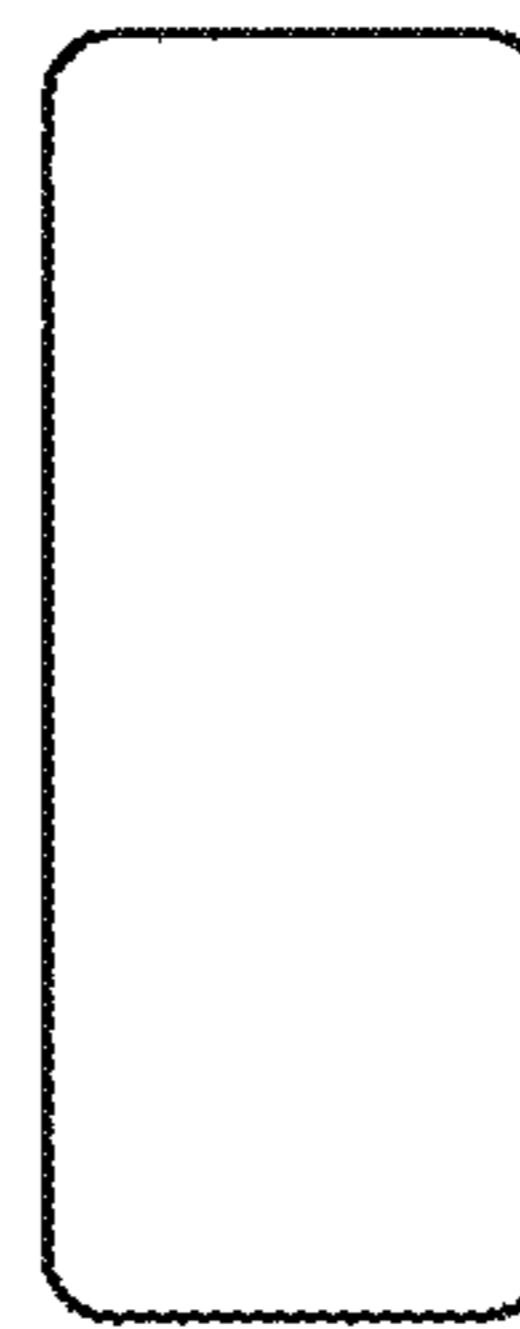

FIG. 4



FIG. 5

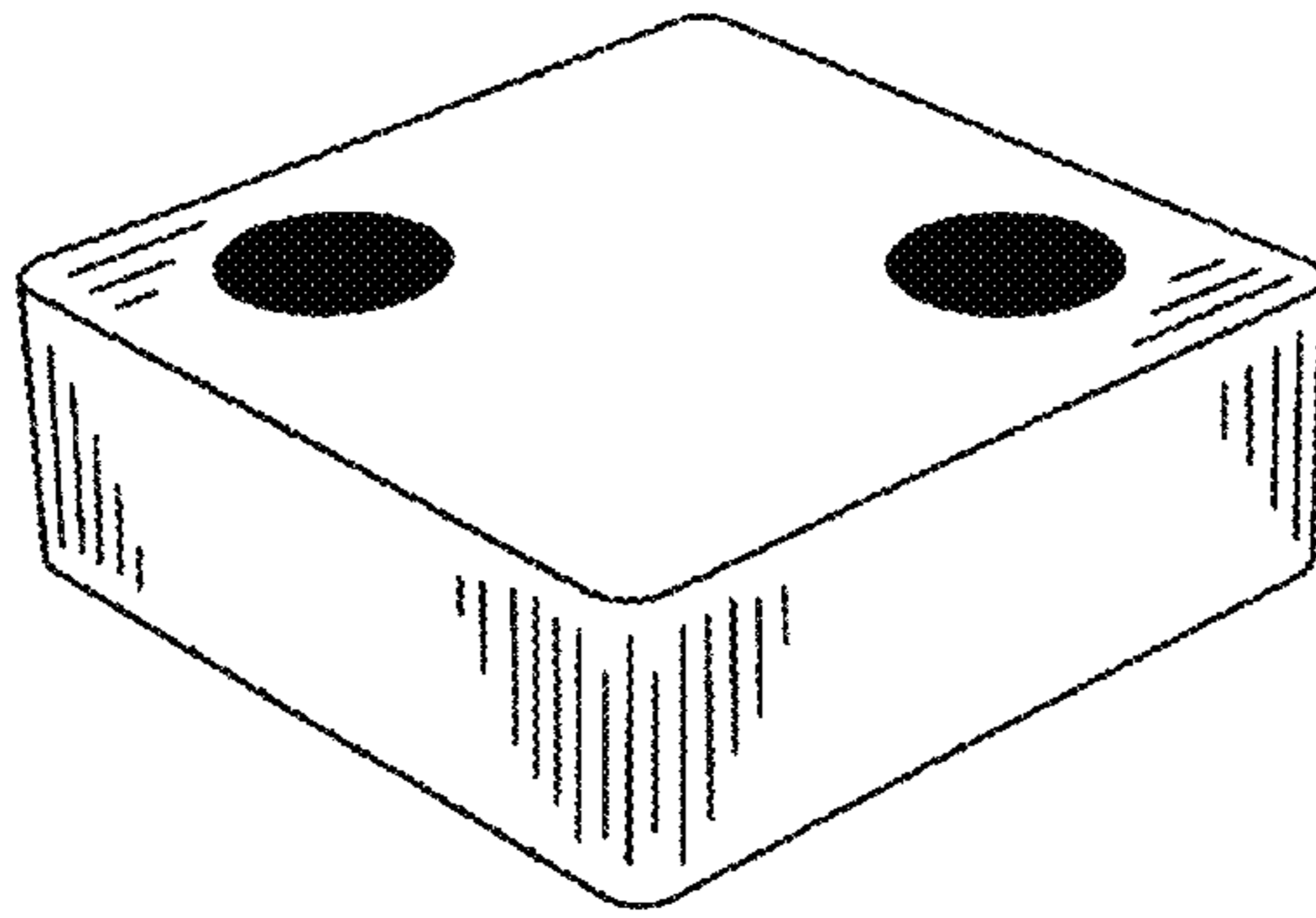

FIG. 6

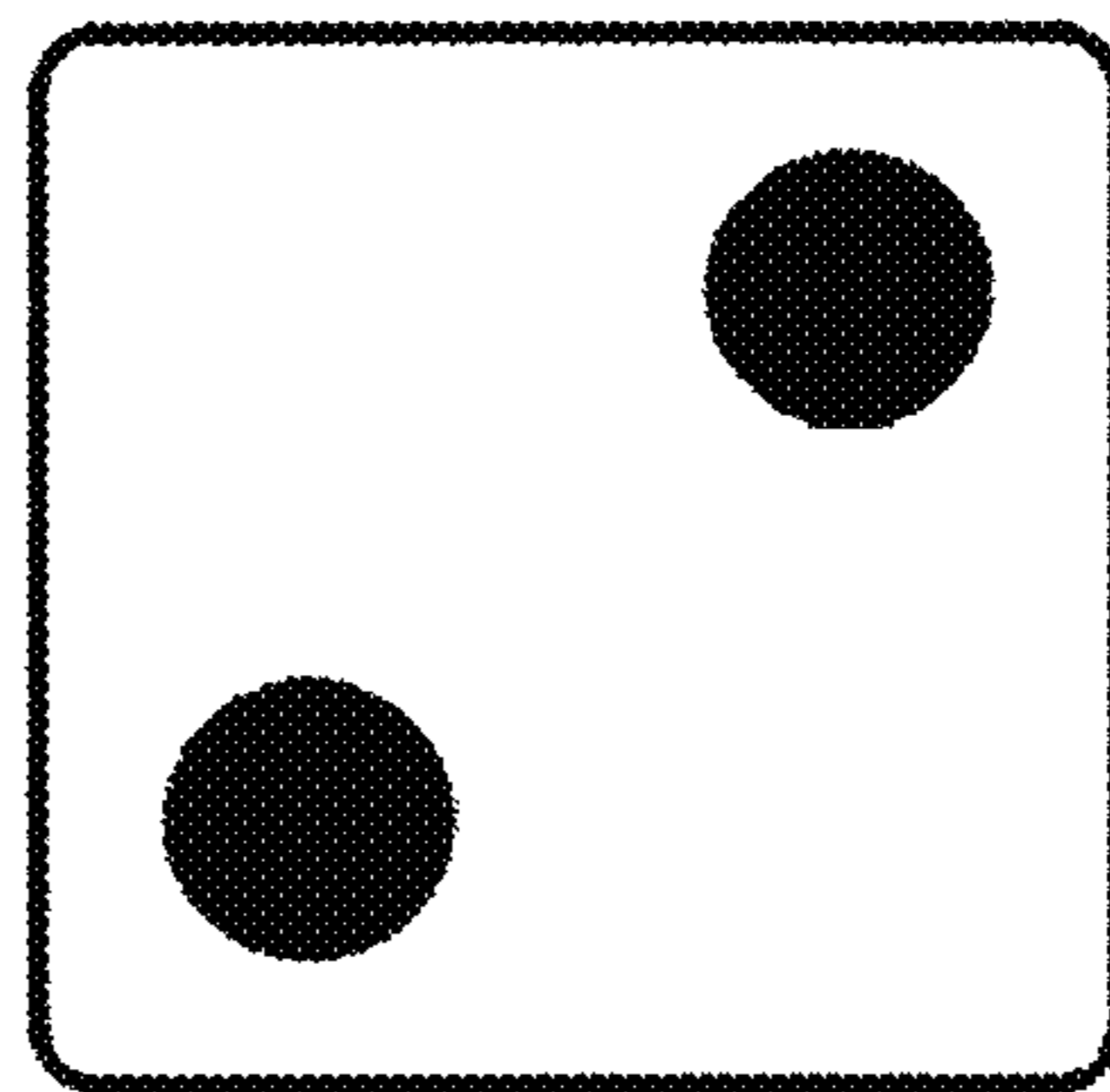

FIG. 7

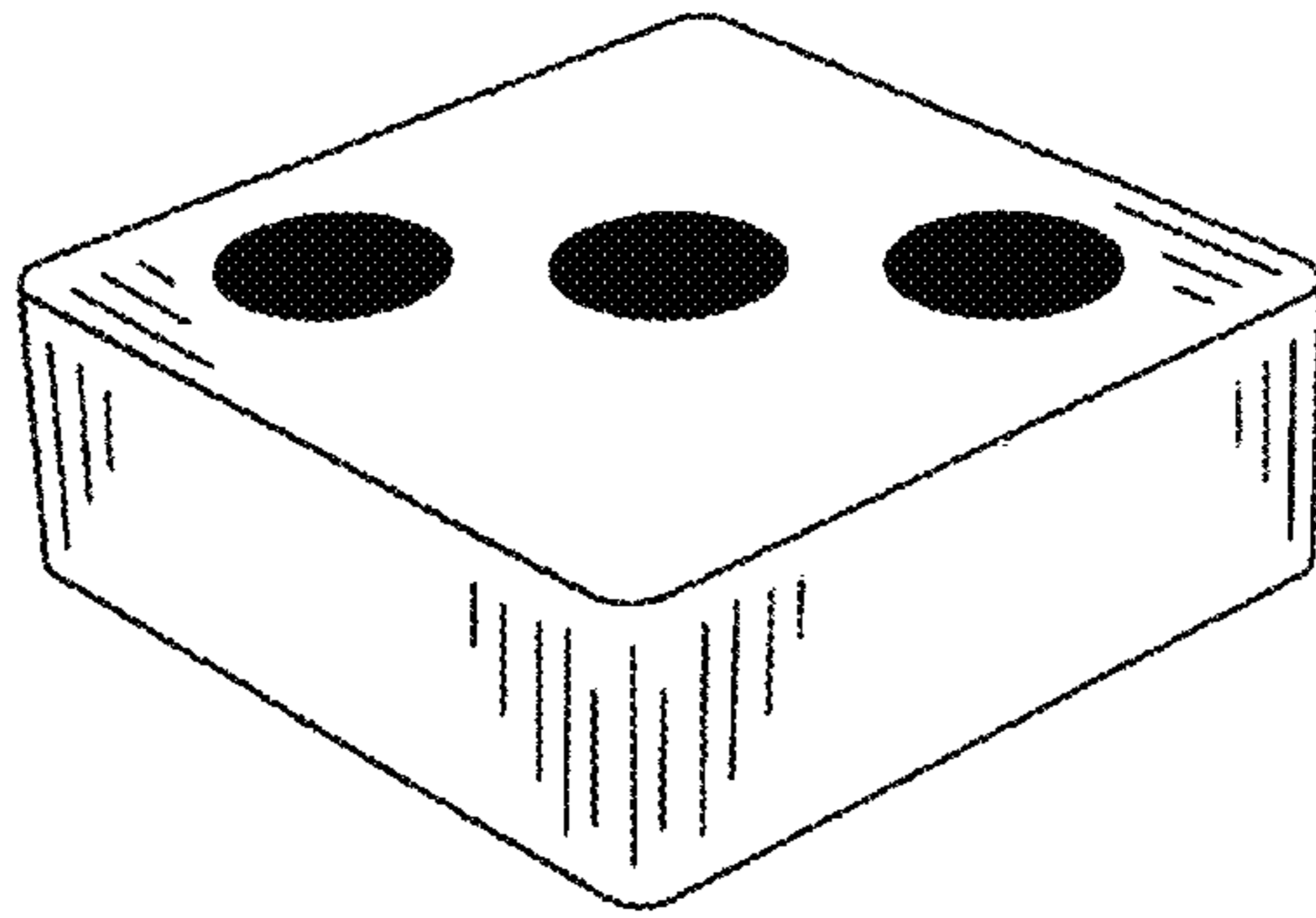

FIG. 8

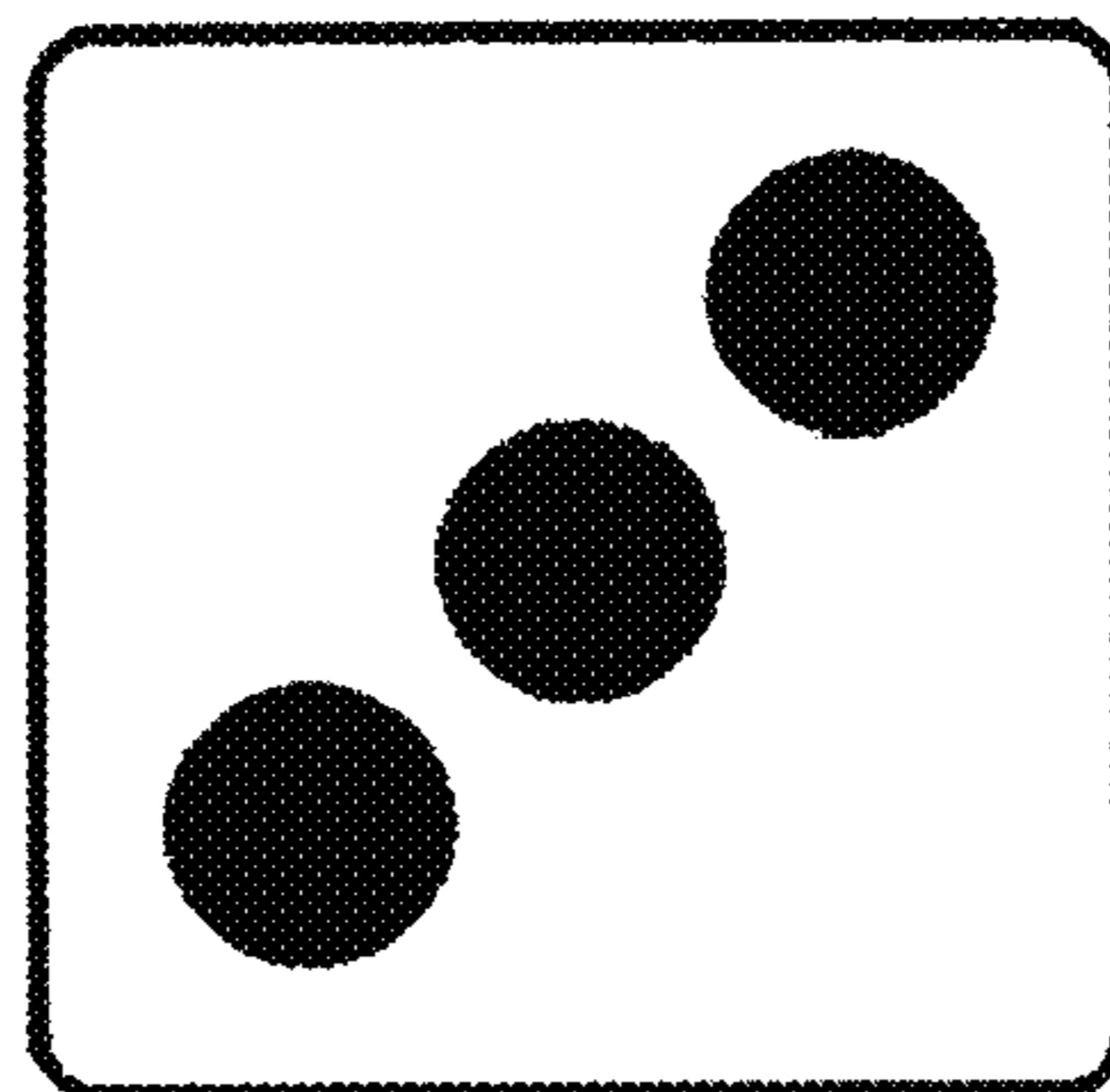

FIG. 9

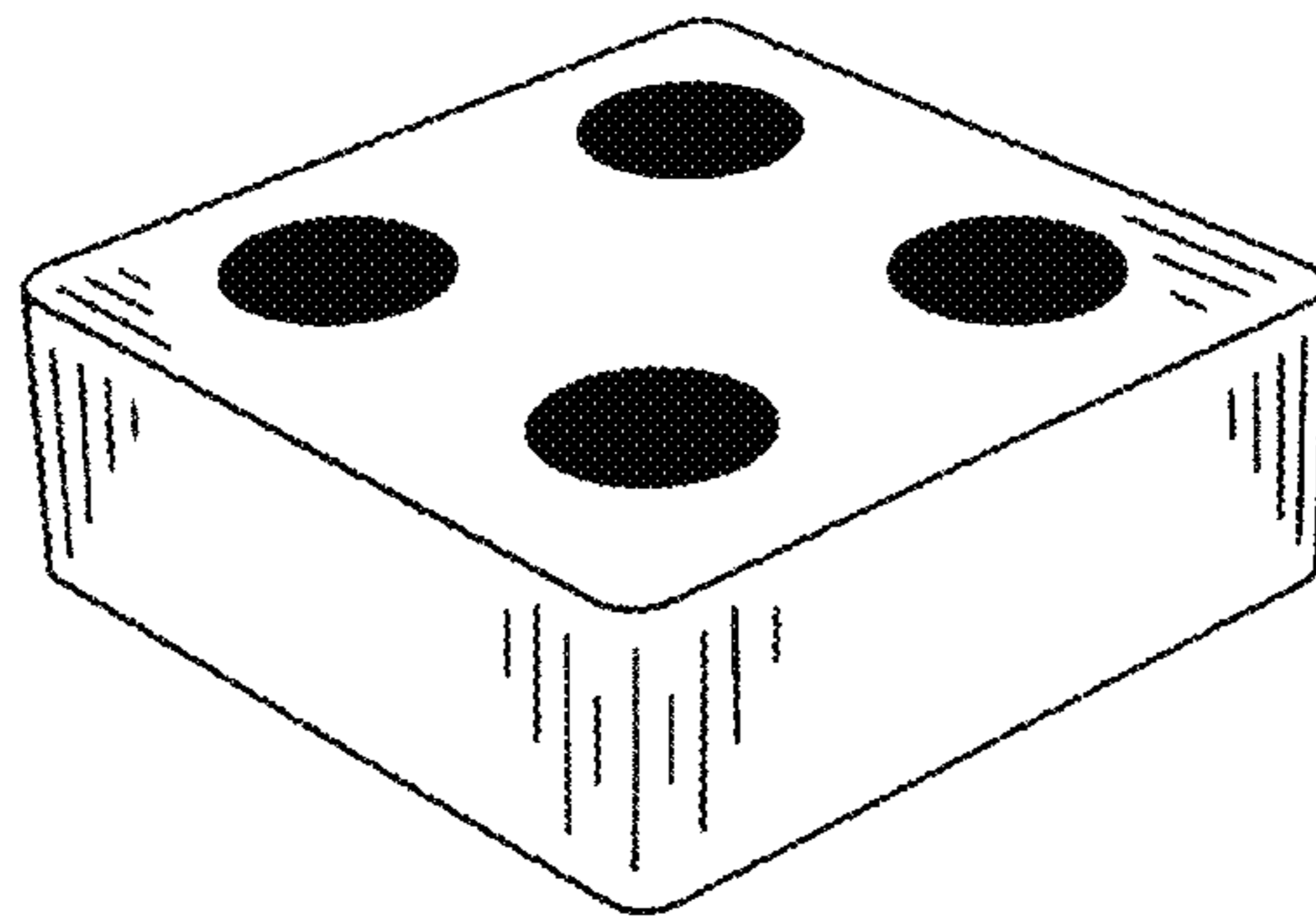

FIG. 10

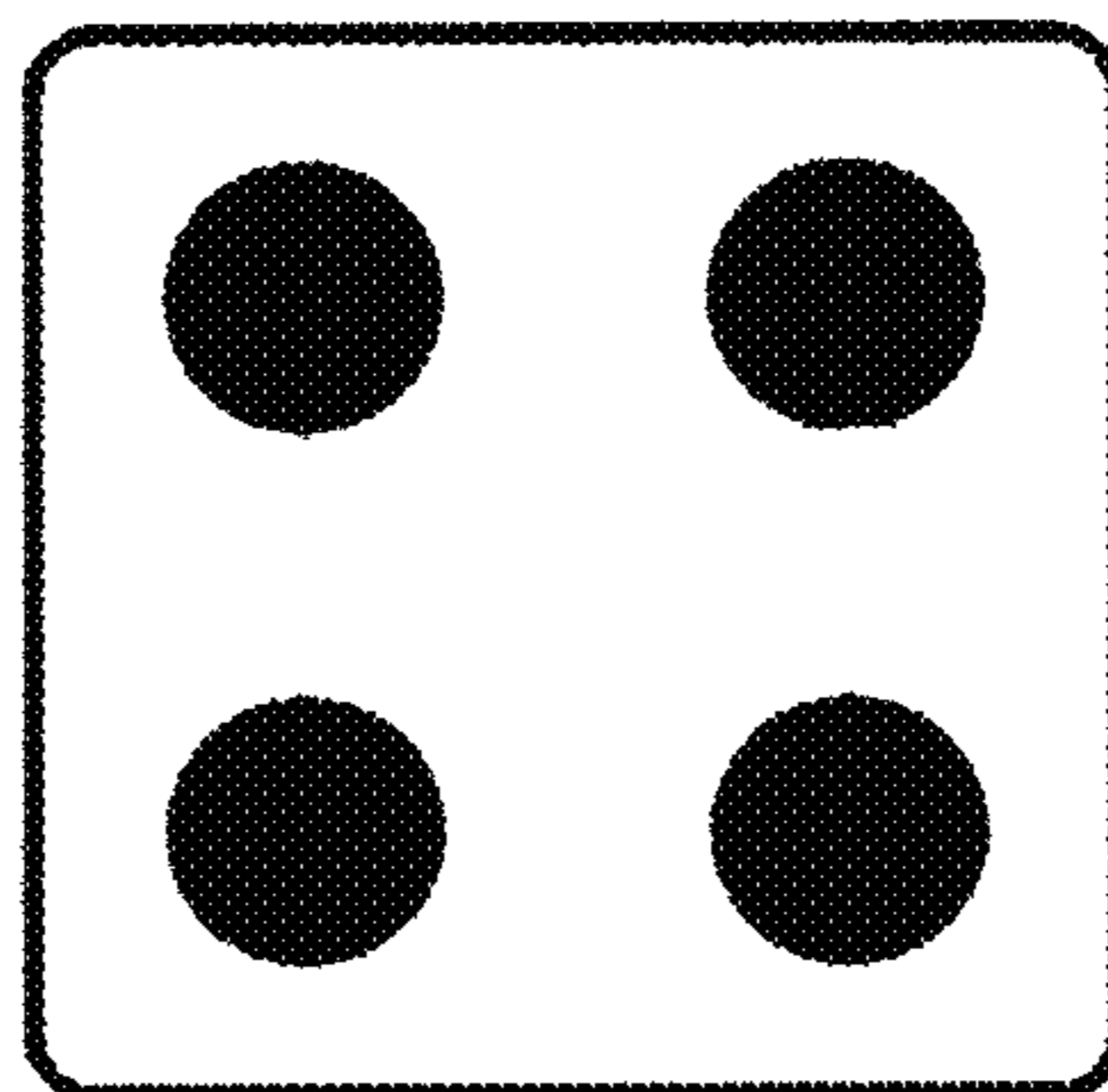

FIG. 11

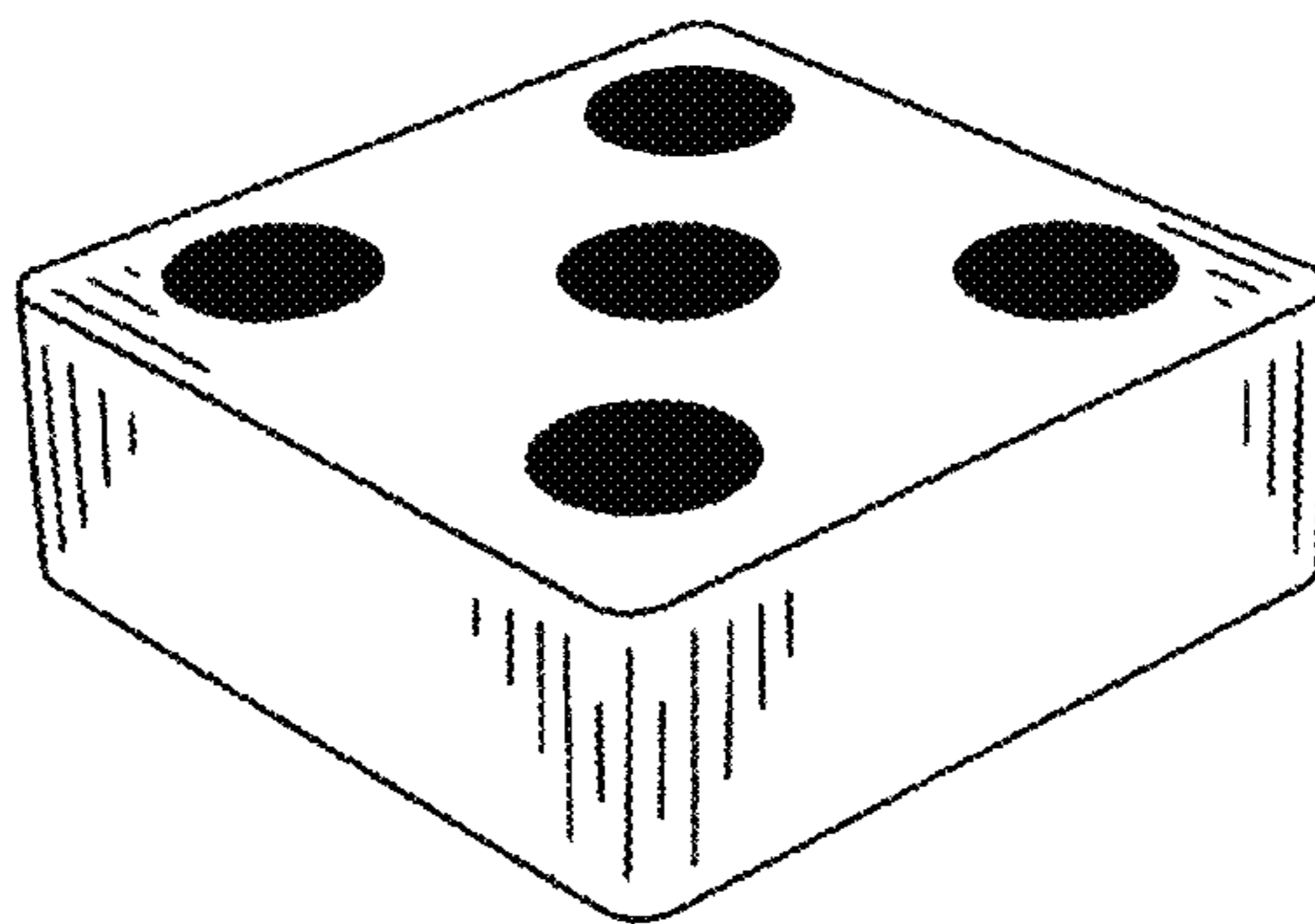

FIG. 12

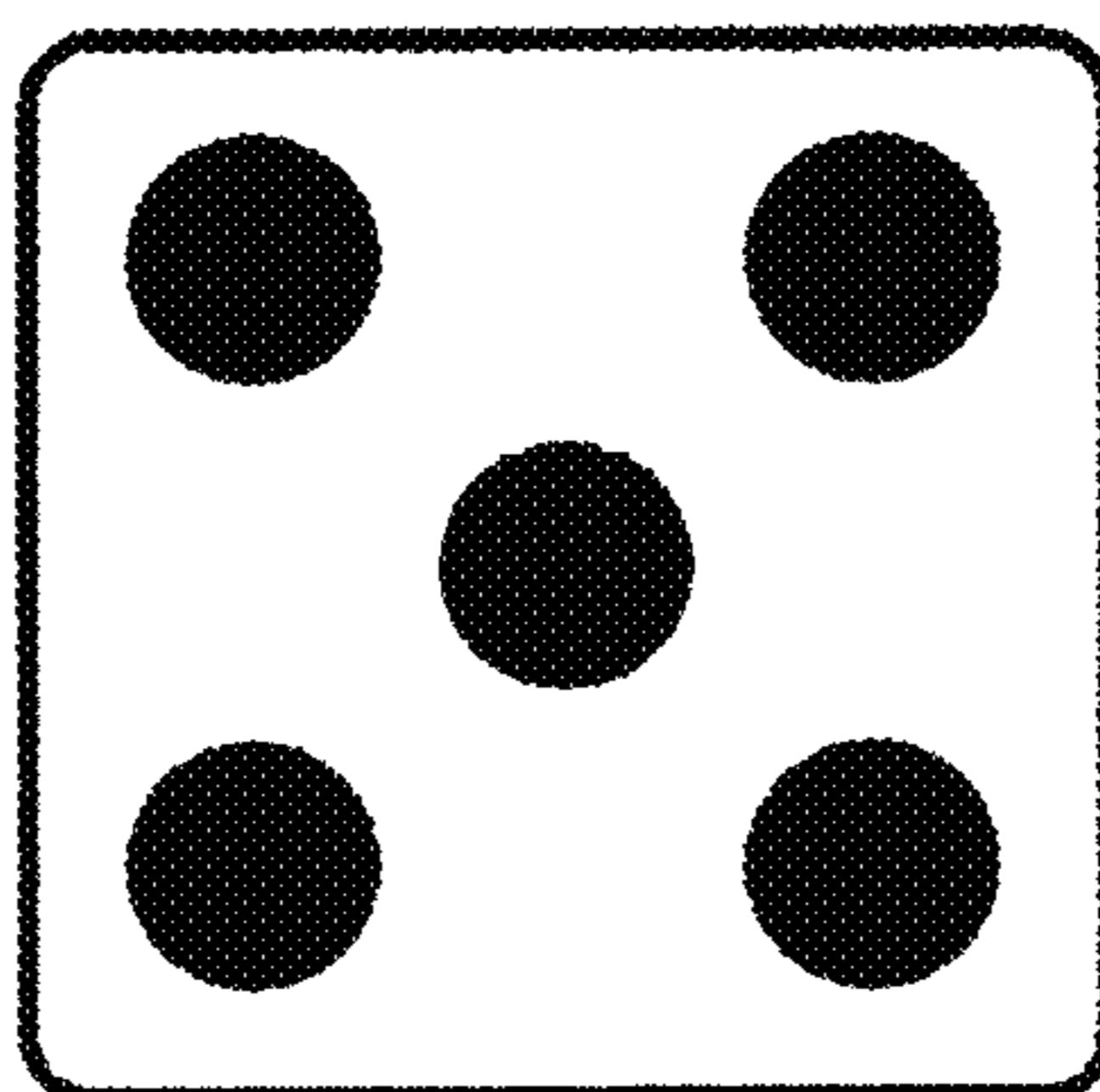

FIG. 13

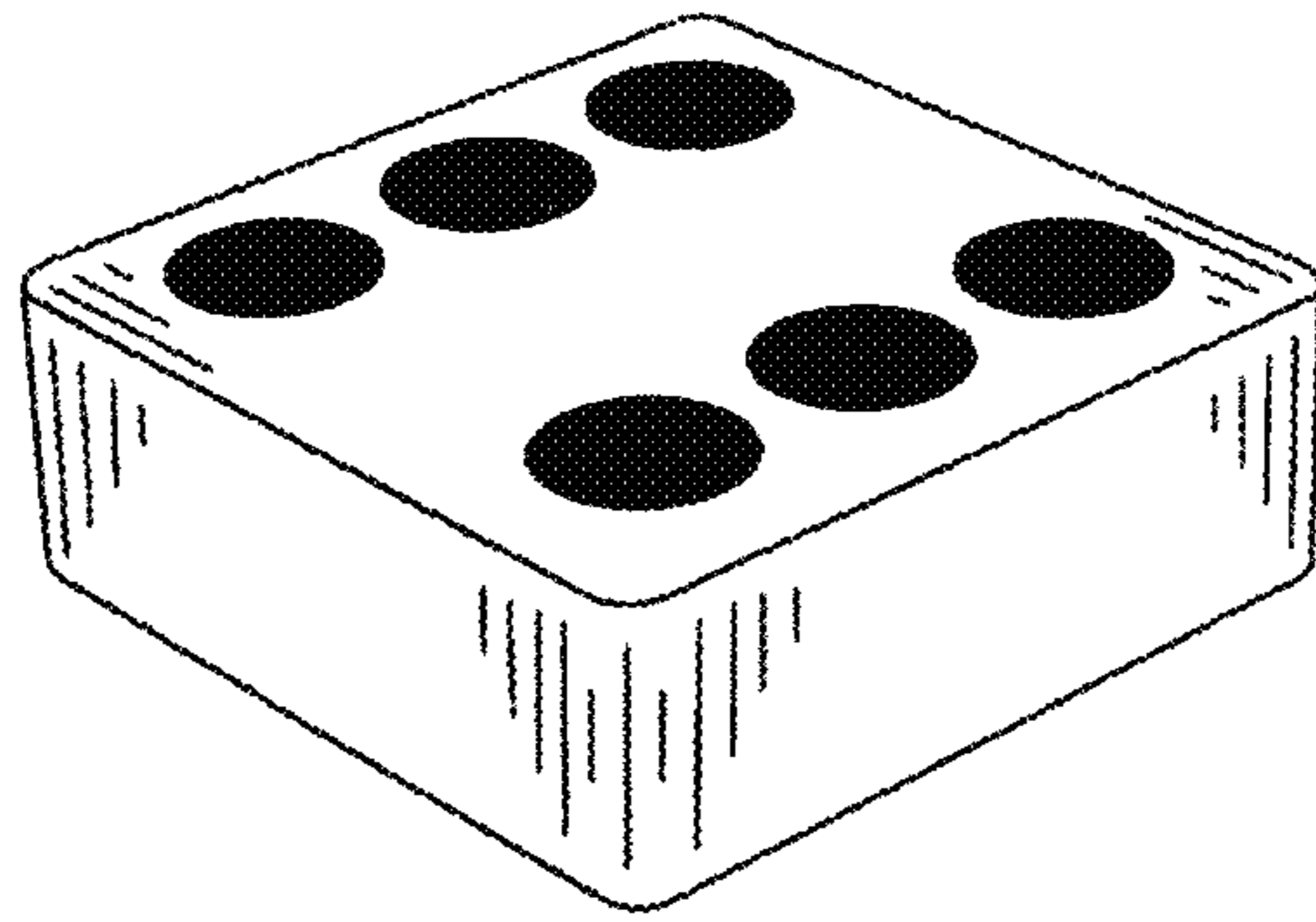

FIG. 14

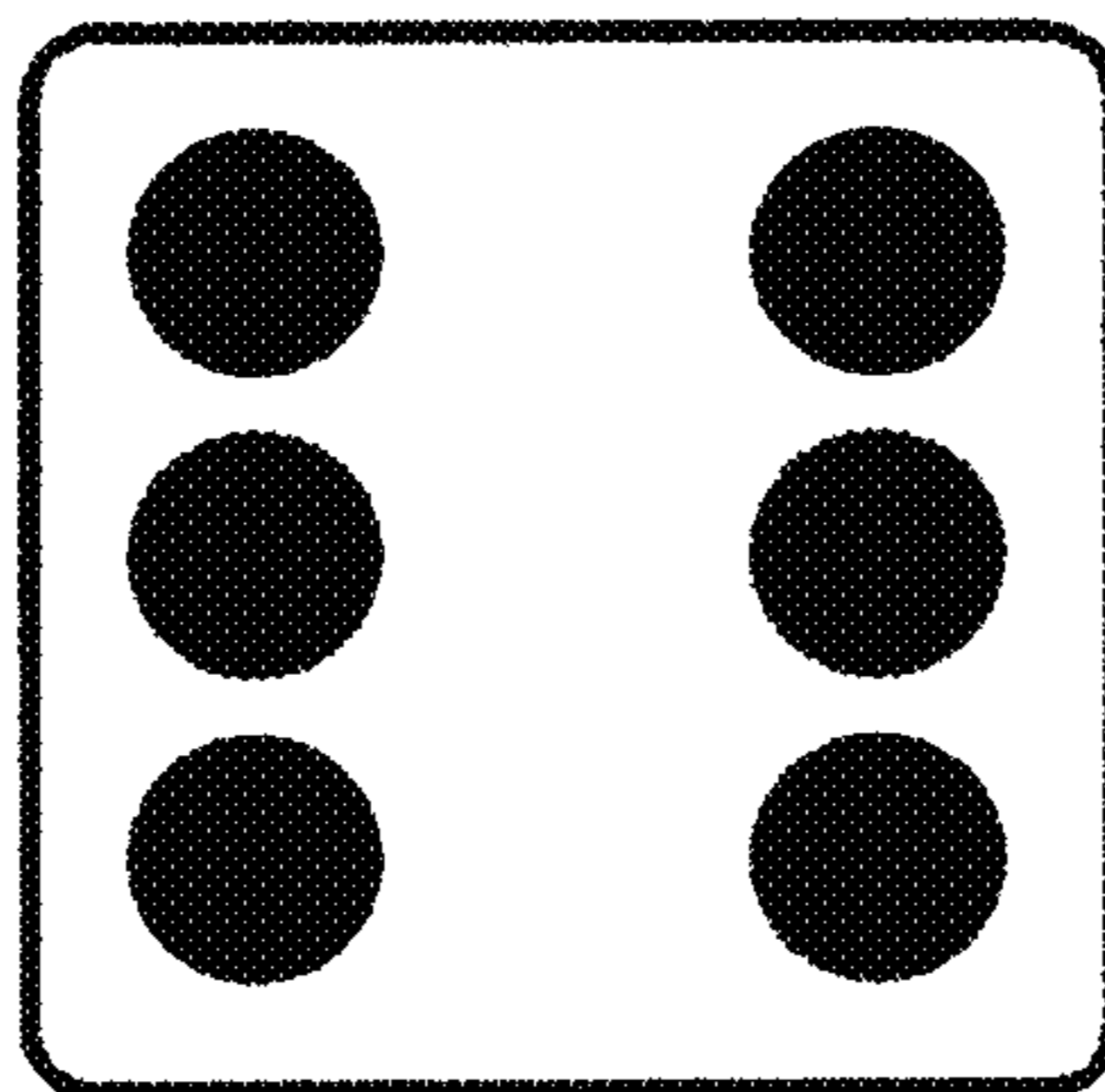

FIG. 15

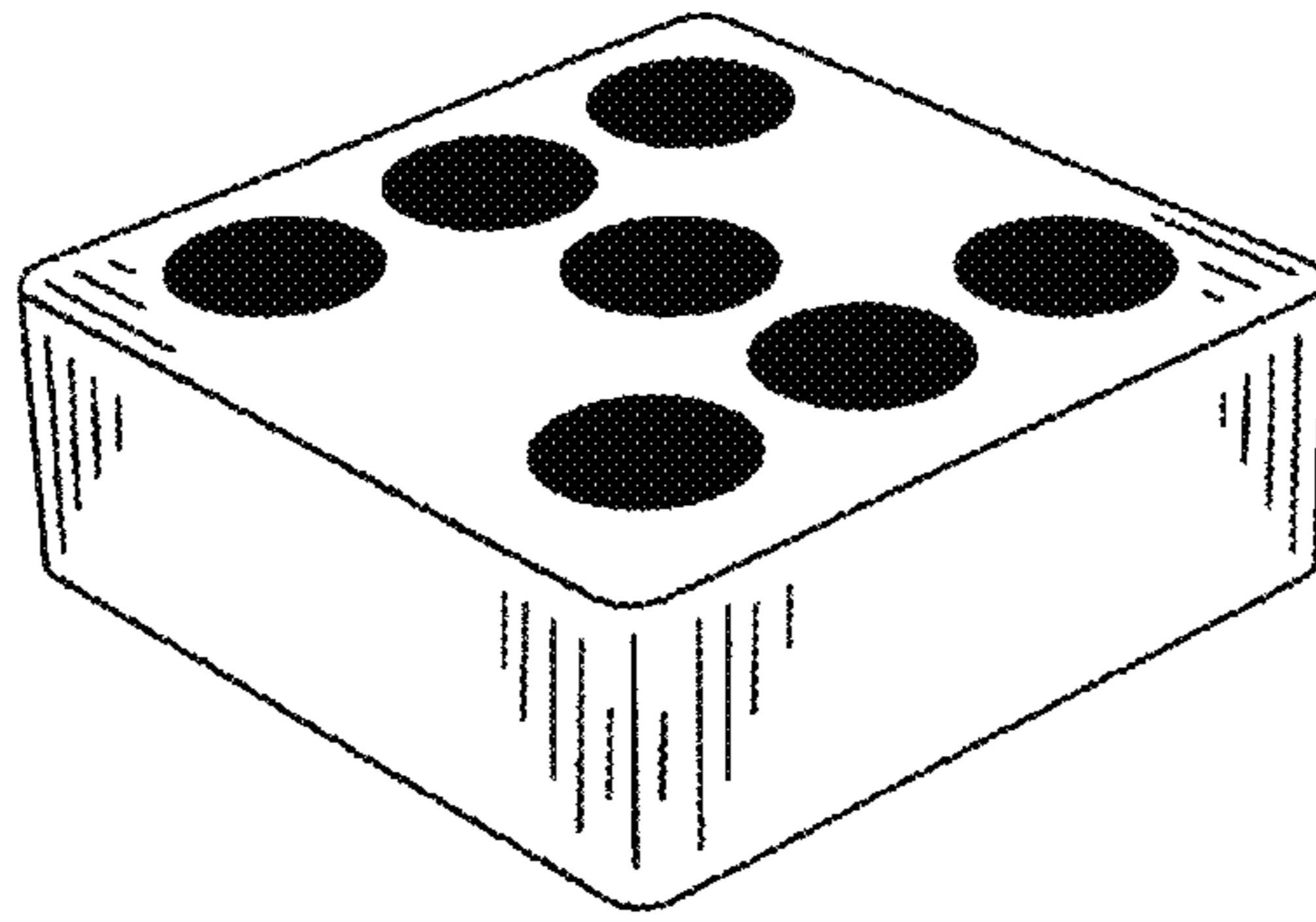

FIG. 16

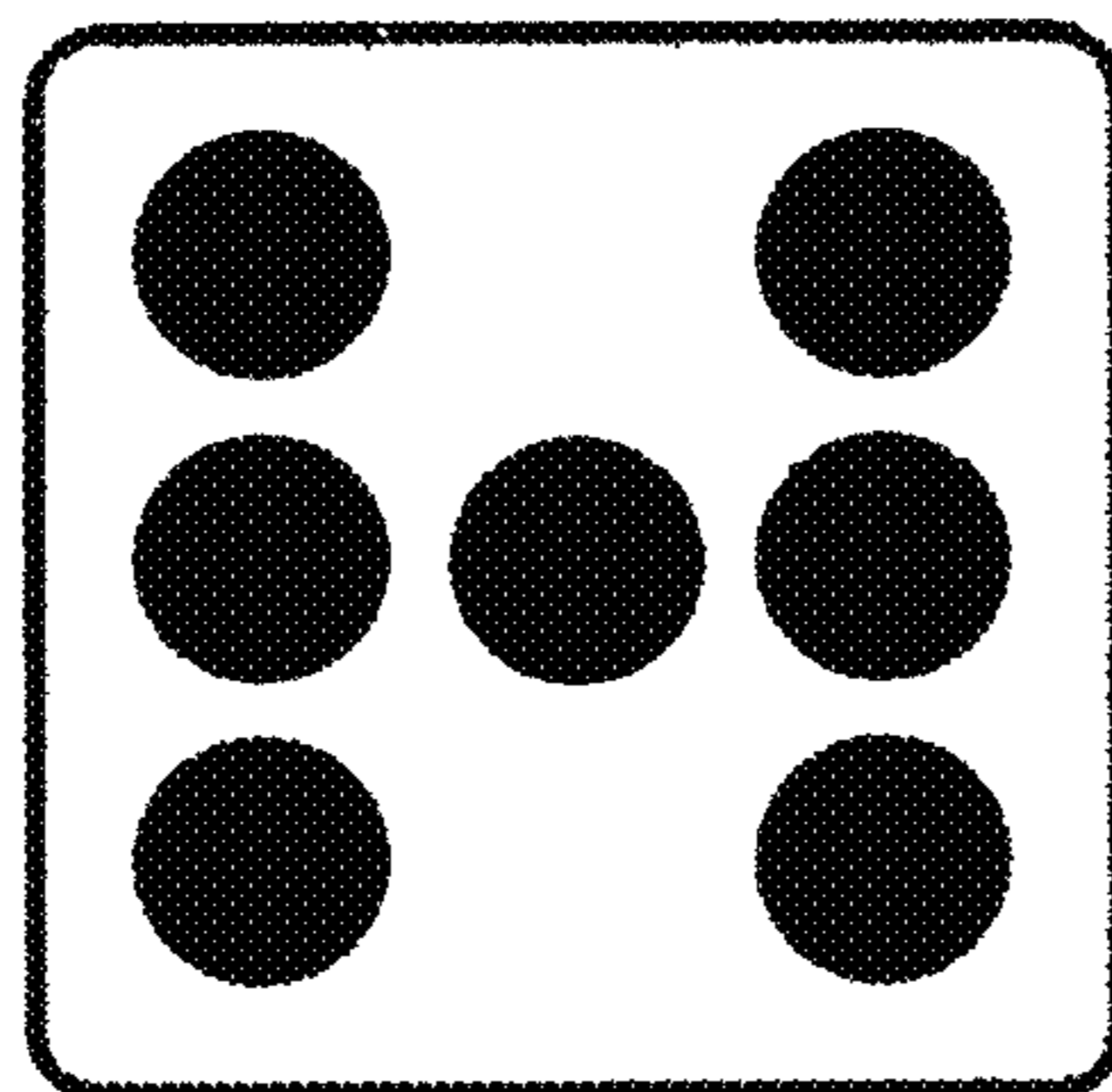

FIG. 17

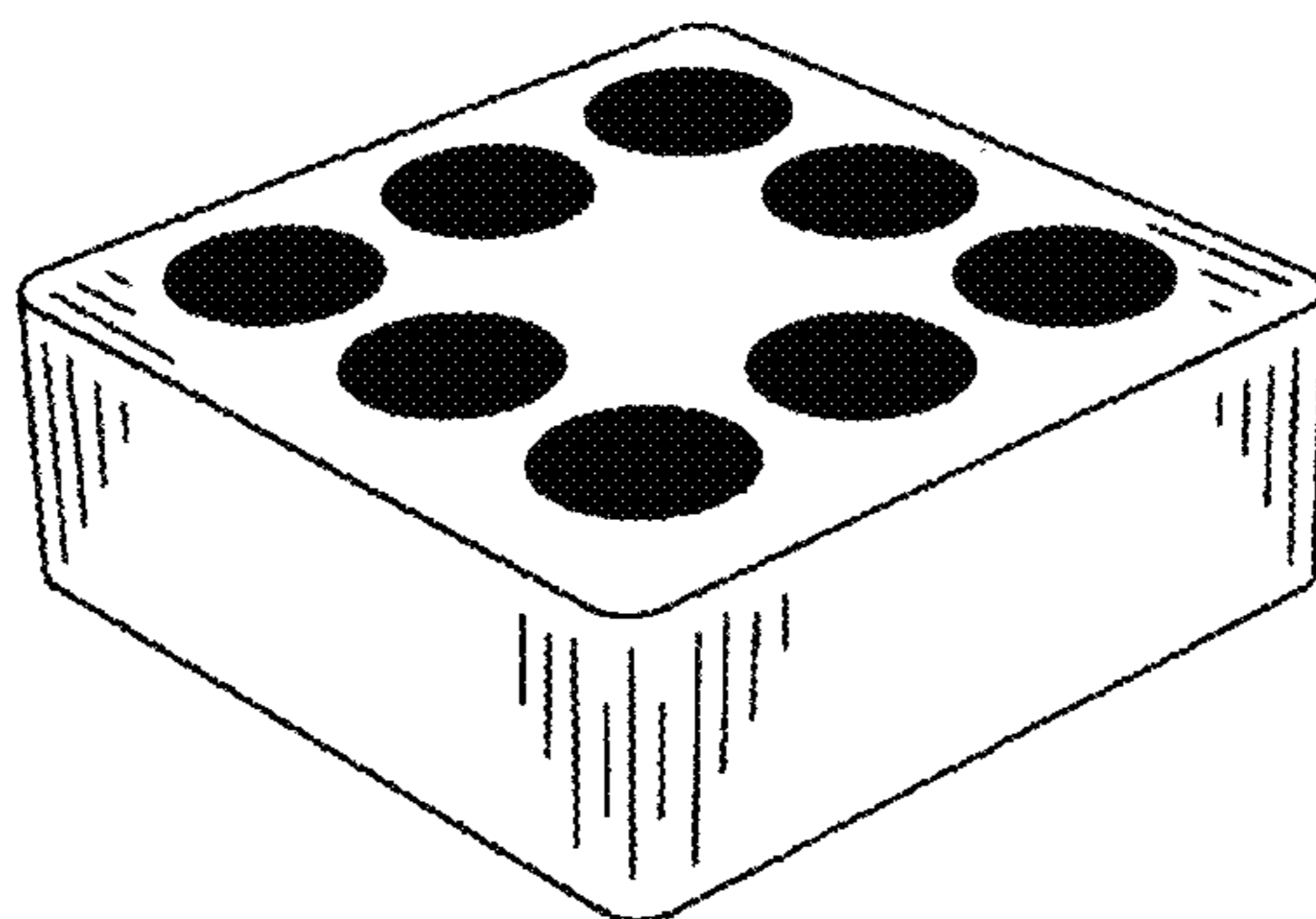

FIG. 18

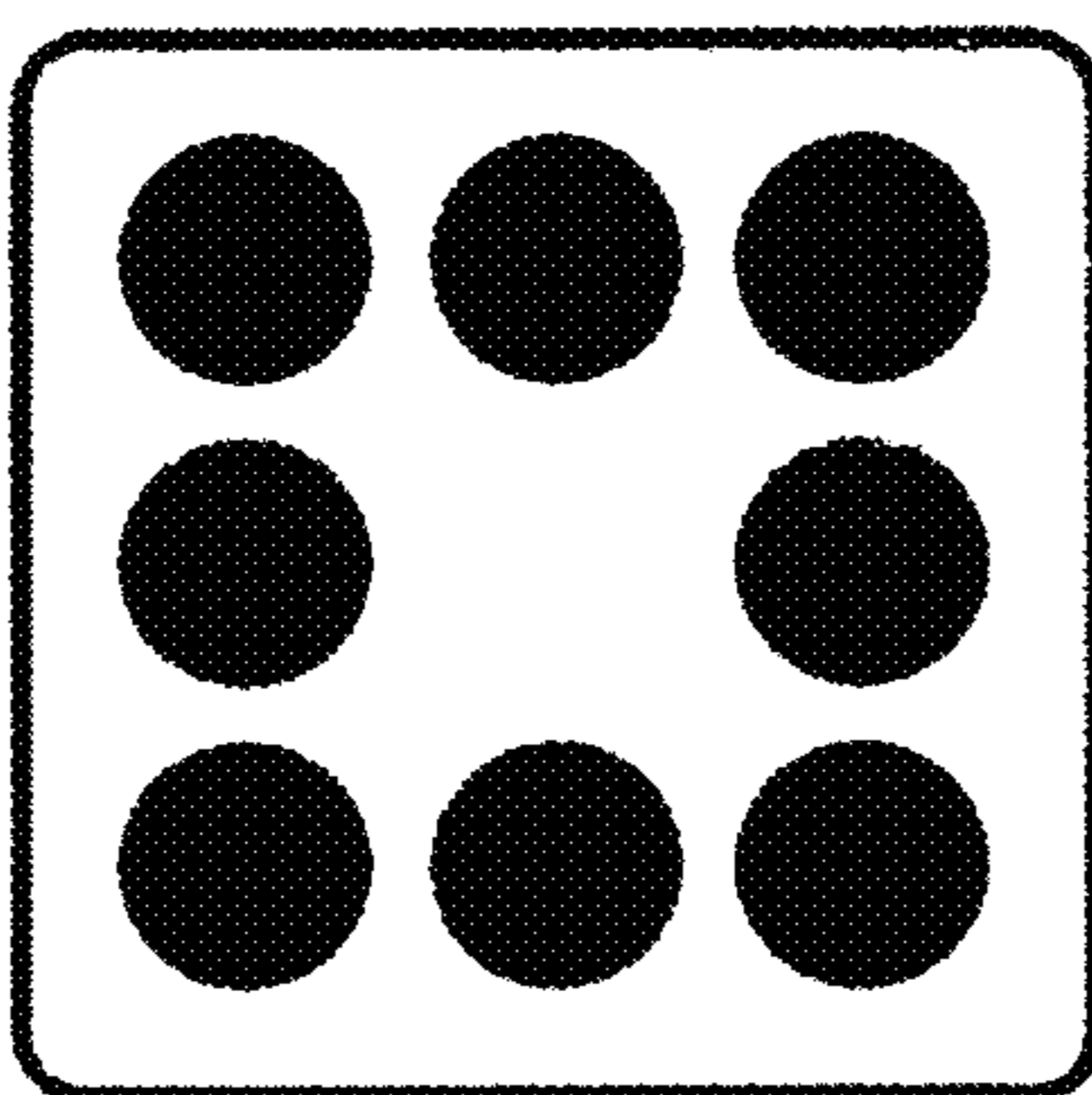

FIG. 19

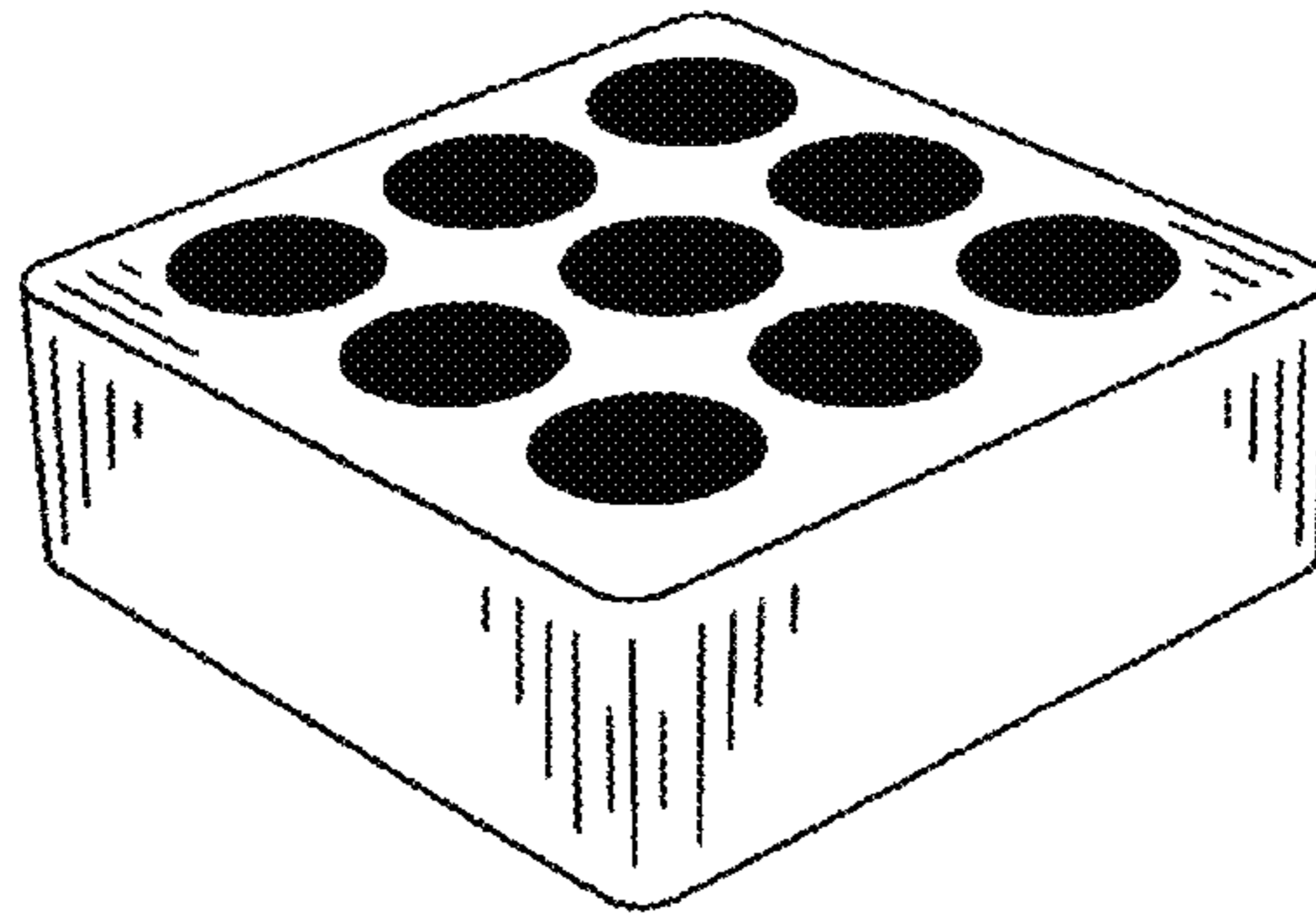
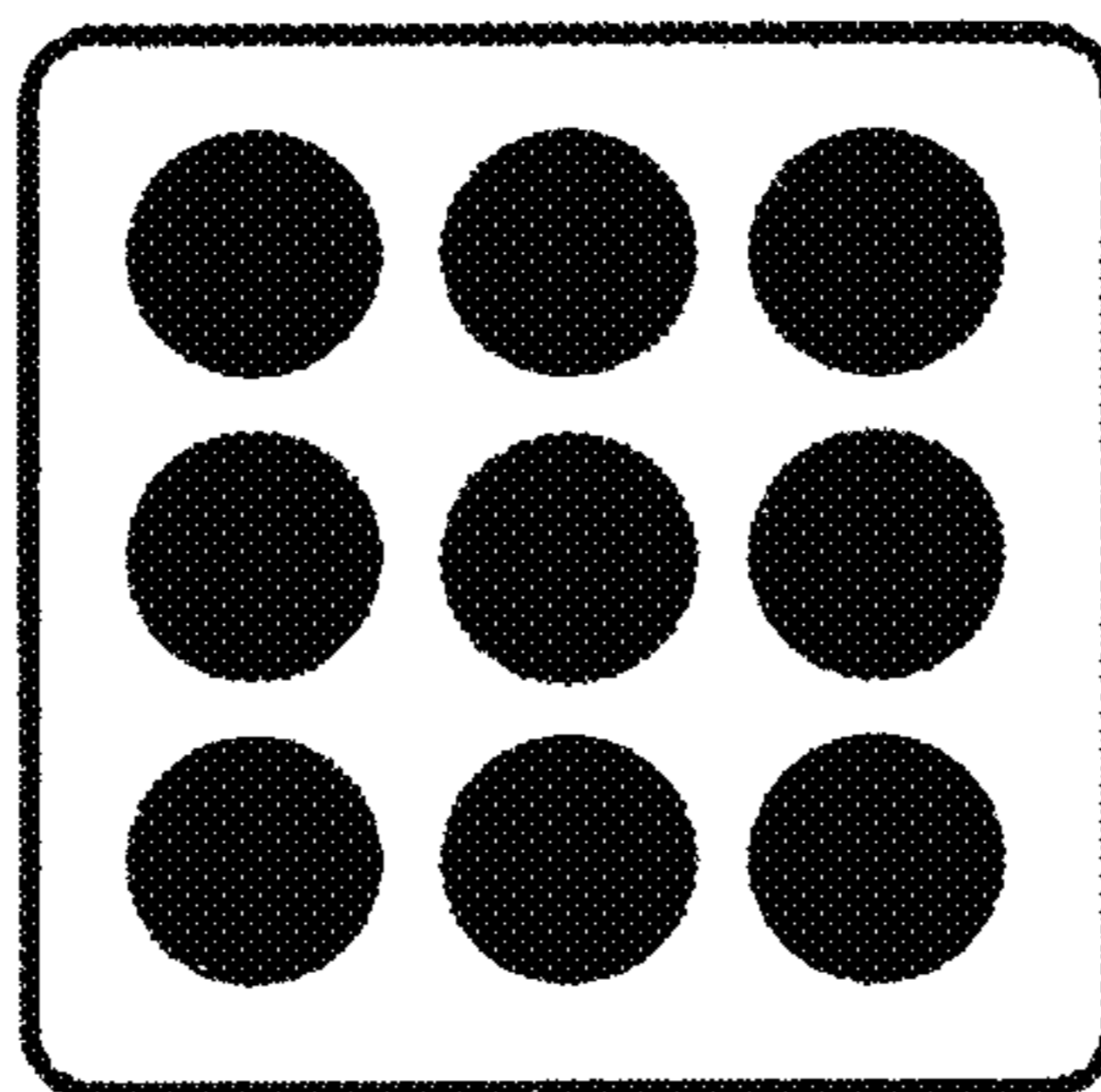

FIG. 20



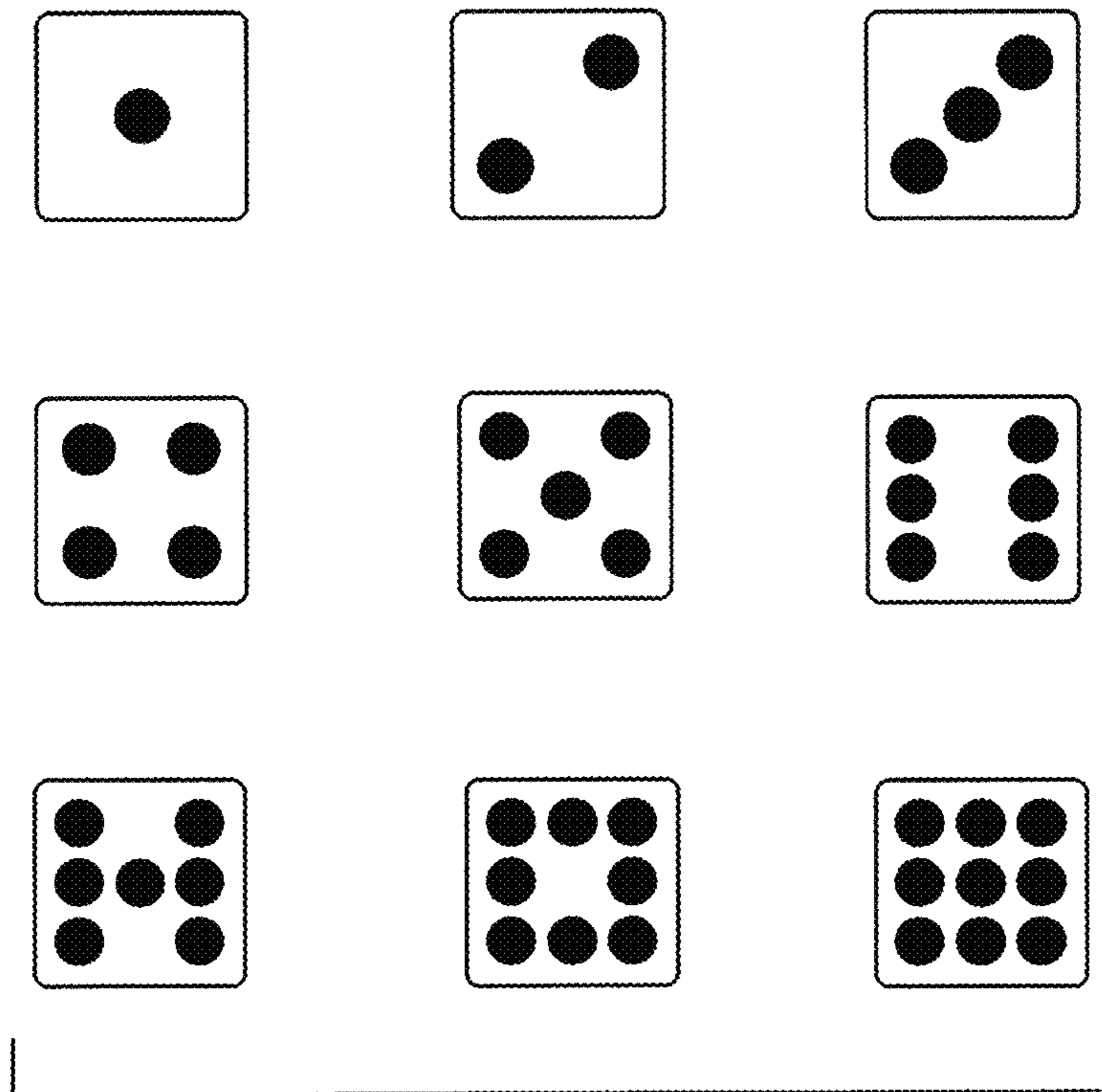

FIG. 21