



US00D789355S

(12) **United States Design Patent**
Cebe

(10) **Patent No.:** **US D789,355 S**
(45) **Date of Patent:** **** Jun. 13, 2017**

(54) **TABLET WITH DETACHABLE KEYBOARD**

8,699,215 B2 * 4/2014 Whitt, III G06F 1/1618
345/169

(71) Applicant: **Hewlett-Packard Development
Company, L.P.**, Houston, TX (US)

D705,774 S * 5/2014 Hung D14/316
D720,741 S * 1/2015 Leonard D14/315
9,007,761 B2 * 4/2015 Wolff G06F 1/1632

(72) Inventor: **Chrome Manley Cebe**, Houston, TX
(US)

9,141,146 B2 * 9/2015 Ke G06F 1/1679
9,256,256 B2 * 2/2016 Liang G06F 1/1632
2002/0145846 A1 * 10/2002 Helot G06F 1/1683
361/679.27

(73) Assignee: **Hewlett-Packard Developmet
Company, L.P.**, Houston, TX (US)

(Continued)

(**) Term: **15 Years**

Primary Examiner — Freda S Nunn

(21) Appl. No.: **29/555,258**

(74) *Attorney, Agent, or Firm* — Foley & Lardner

(22) Filed: **Feb. 19, 2016**

(57) **CLAIM**

(51) **LOC (10) Cl.** **14-02**

I claim the ornamental design for a tablet with detachable keyboard, as shown and described.

(52) **U.S. Cl.**

DESCRIPTION

USPC **D14/341**; D14/315

(58) **Field of Classification Search**

USPC D14/315–327, 341, 434, 391–399;
D18/1, 2, 7, 11; 235/145 A, 145 R;
341/22, 23; 345/104, 156, 168, 169, 173;
361/679.08, 679.09, 679.11, 679.26,
361/679.27

CPC G06F 1/16; G06F 1/1616; G06F 1/1626;
G06F 1/1632; G06F 1/1613; G06F
1/1601; G06F 1/1618; G06F 1/162; G06F
1/166; G06F 1/1654; G06F 1/1681; G06F
1/1637; G06F 1/1688; H01R 35/02;
H03M 11/00; G09B 13/04; H03K 17/94;
G09G 5/00; F16M 11/10; H05K 5/00;
H05K 7/02; H04M 1/0237

See application file for complete search history.

FIG. 1 is front, top, left isometric view of the claimed design in a first configuration according to an embodiment; FIG. 2 is a front elevational view thereof; FIG. 3 is a rear elevational view thereof; FIG. 4 is a top plan view thereof; FIG. 5 is a bottom plan view thereof; FIG. 6 is a left side elevational view thereof; FIG. 7 is a right side elevational view thereof; FIG. 8 is front, top, left isometric view of the claimed design in a second configuration; FIG. 9 is a front elevational view thereof; FIG. 10 is a rear elevational view thereof; FIG. 11 is a top plan view thereof; FIG. 12 is a bottom plan view thereof; FIG. 13 is a left side elevational view thereof; and, FIG. 14 is a right side elevational view thereof.

The ornamental design which is claimed is shown in solid lines in the drawings. The broken lines formed by dashes show unclaimed subject matter and form no part of the claimed design.

(56) **References Cited**

U.S. PATENT DOCUMENTS

6,317,315 B1 * 11/2001 Lee G06F 1/1601
16/254
8,208,245 B2 * 6/2012 Staats G06F 1/162
361/679.02

1 Claim, 14 Drawing Sheets

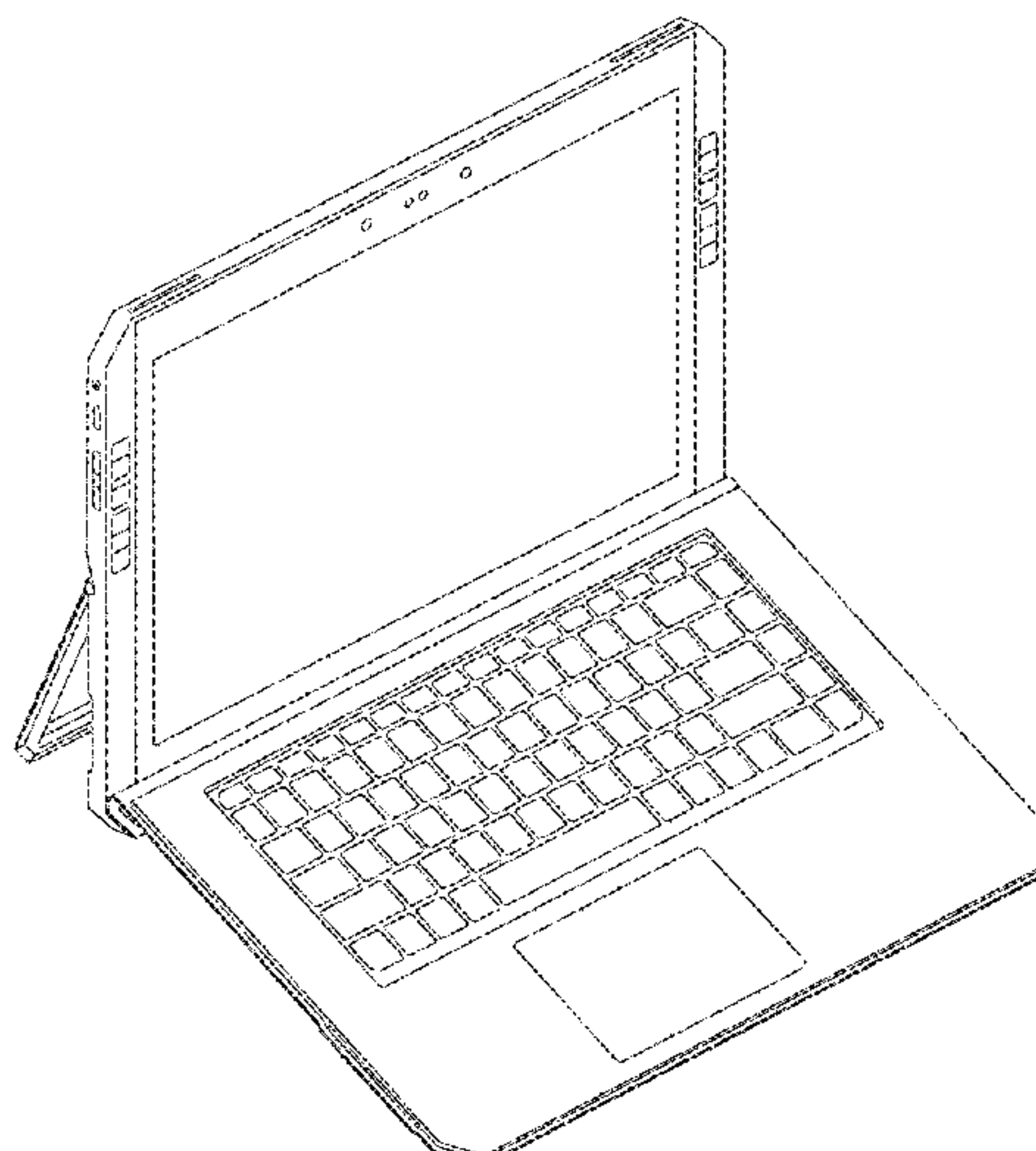

(56)

References Cited

U.S. PATENT DOCUMENTS

2004/0246666	A1 *	12/2004	Maskatia	G06F 1/1616 361/679.57
2011/0162987	A1 *	7/2011	Bekele	G06F 1/1616 206/320
2012/0212900	A1 *	8/2012	Hung	G06F 1/1632 361/679.41
2013/0188304	A1 *	7/2013	Lee	G06F 1/1667 361/679.12

* cited by examiner

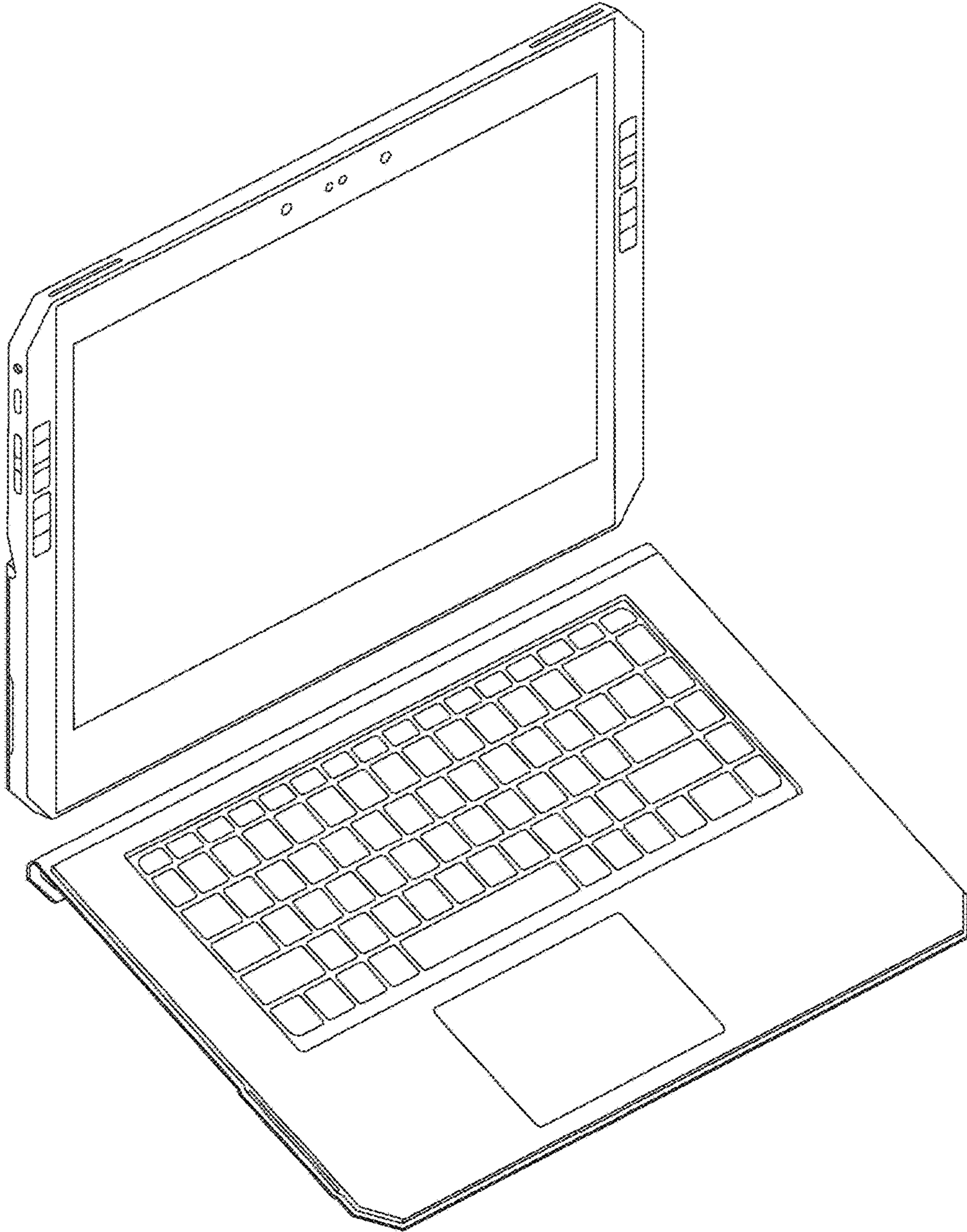

FIG. 1

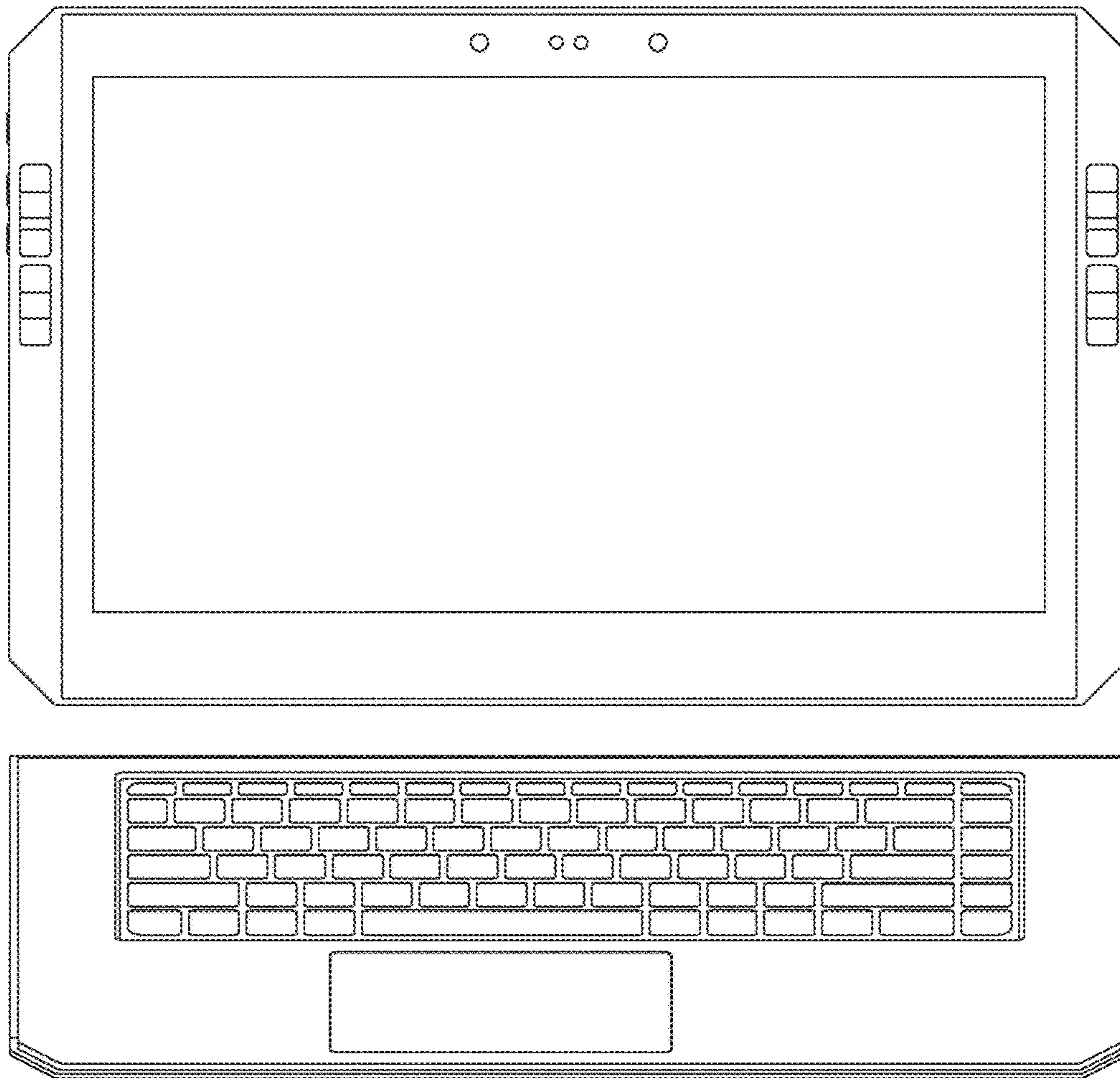

FIG. 2

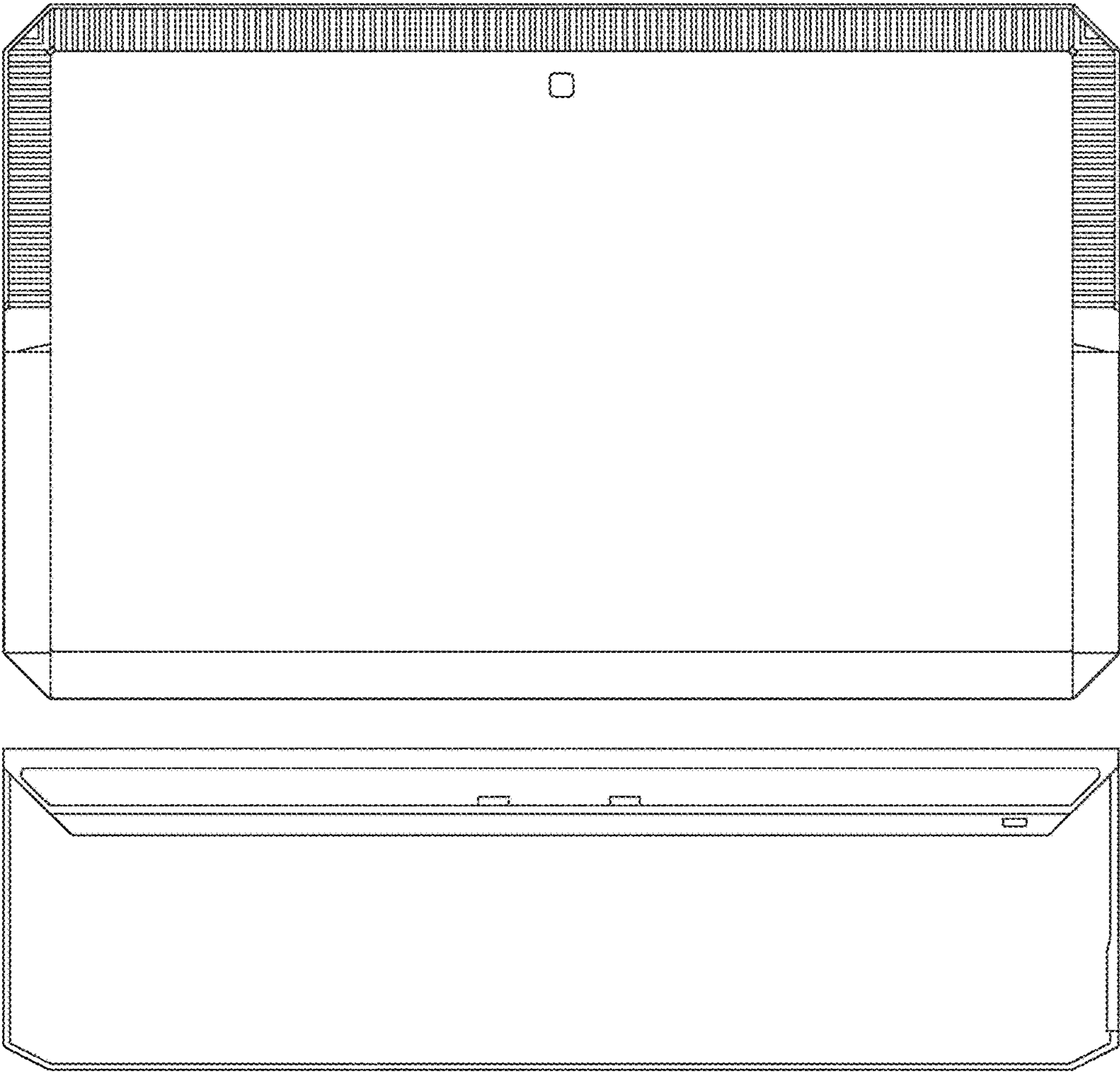

FIG. 3

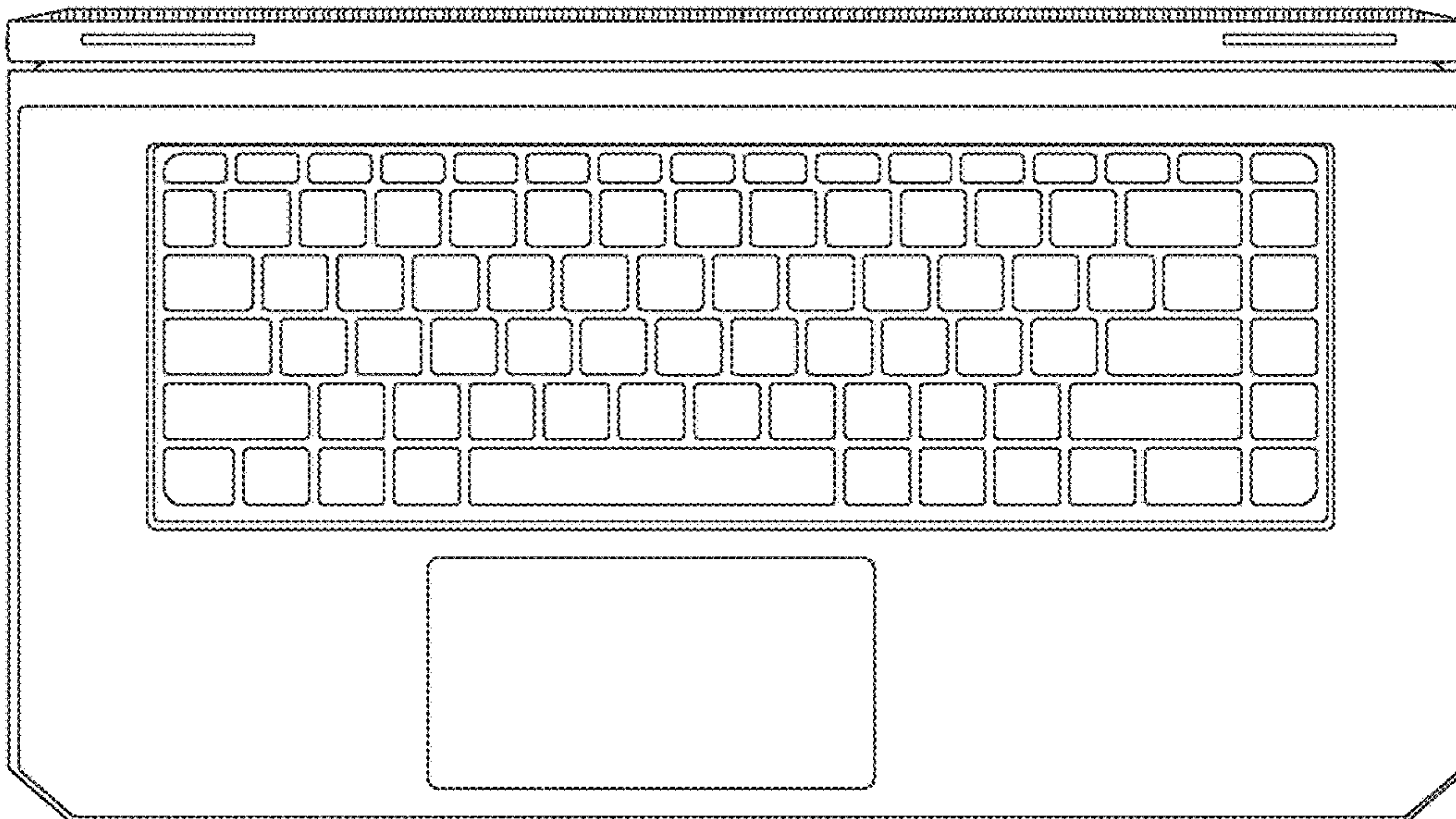

FIG. 4

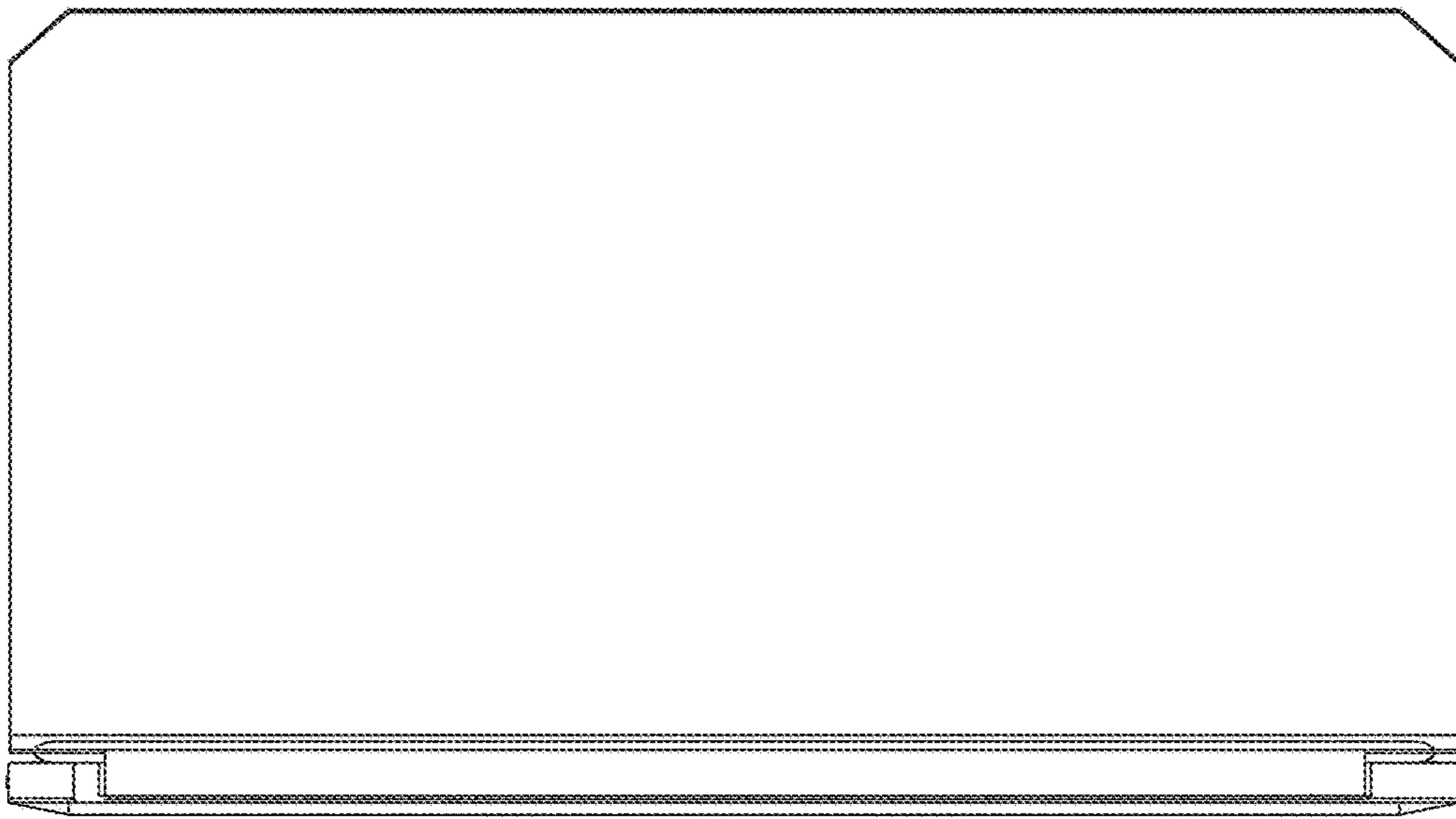

FIG. 5

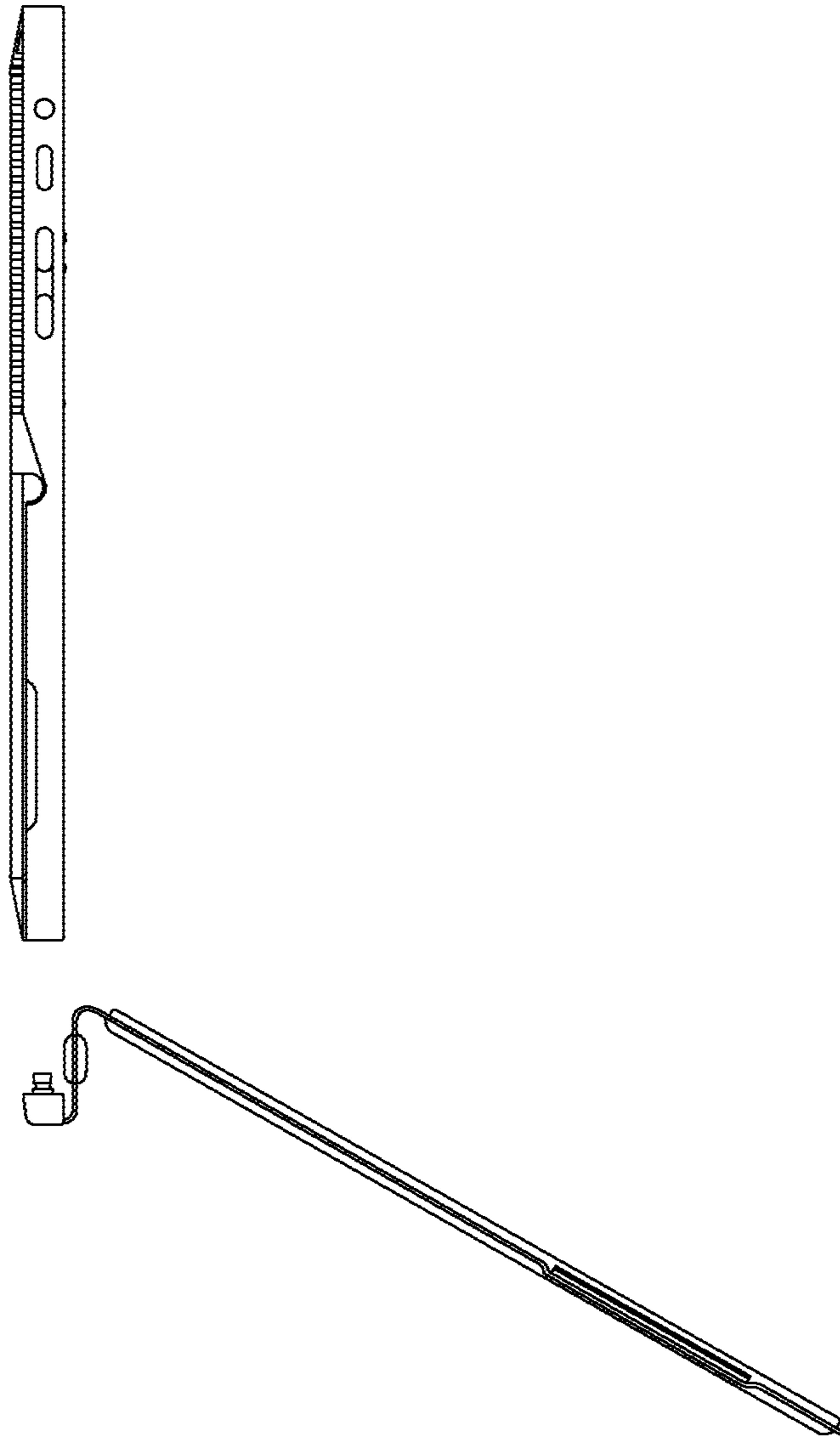

FIG. 6

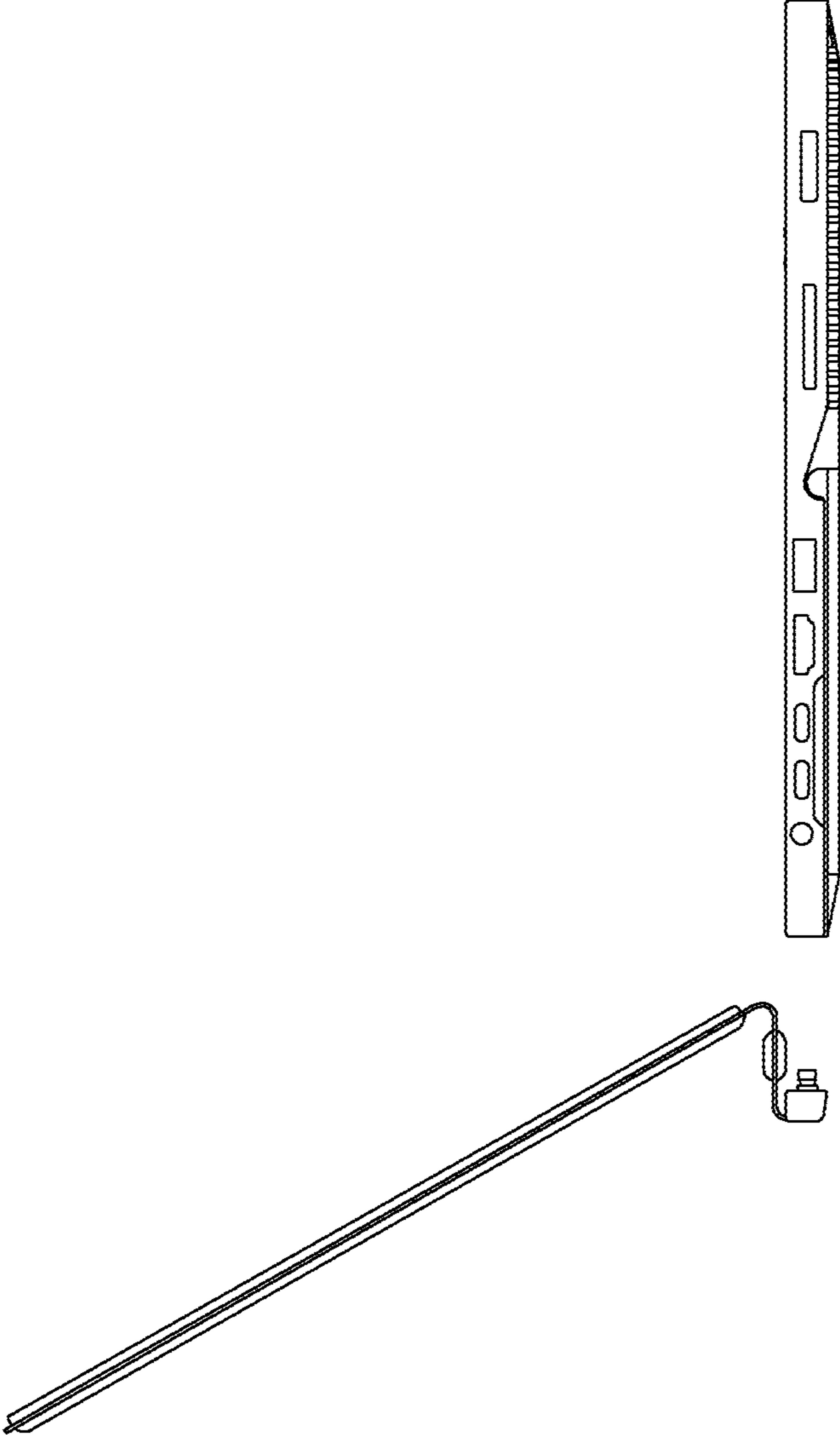

FIG. 7

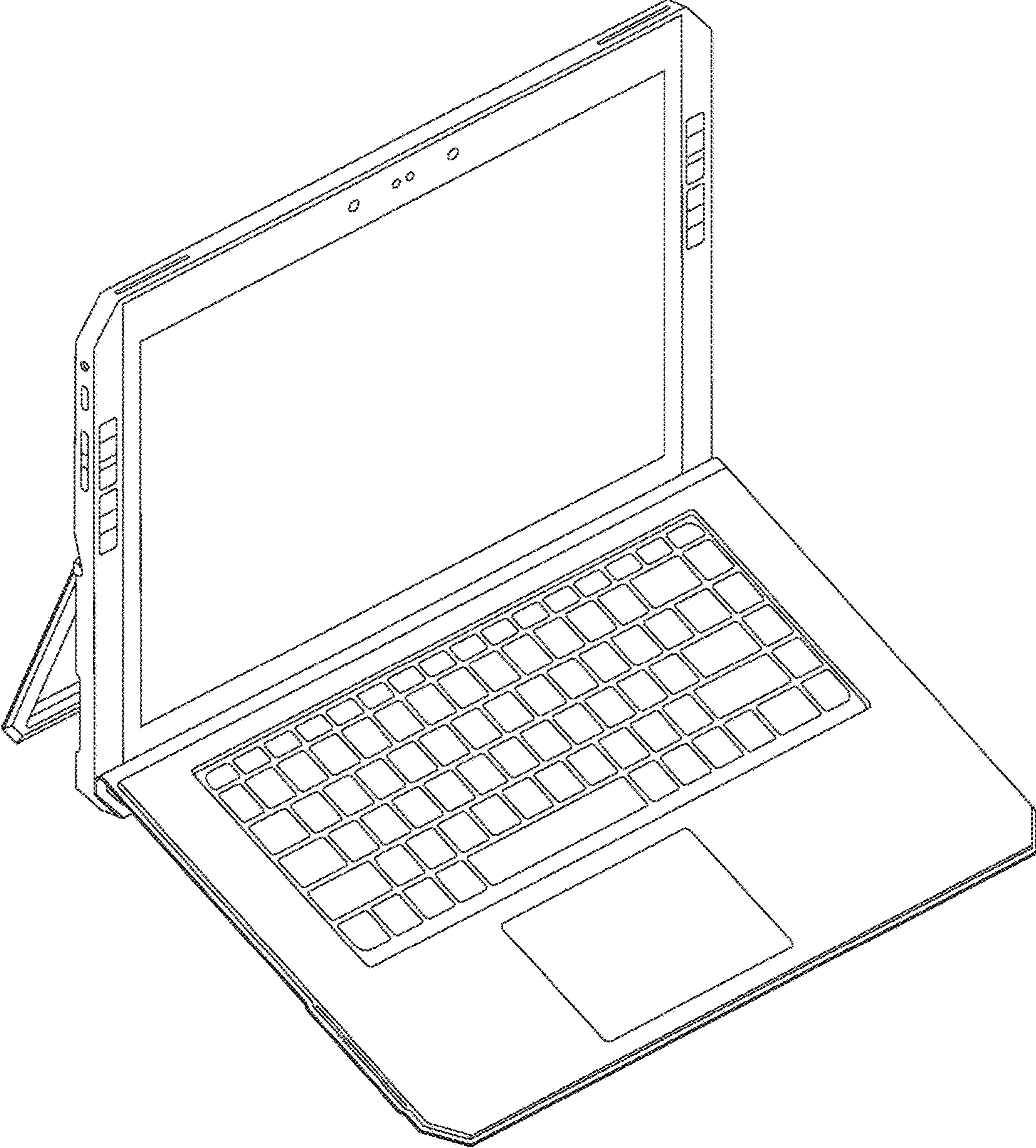

FIG. 8

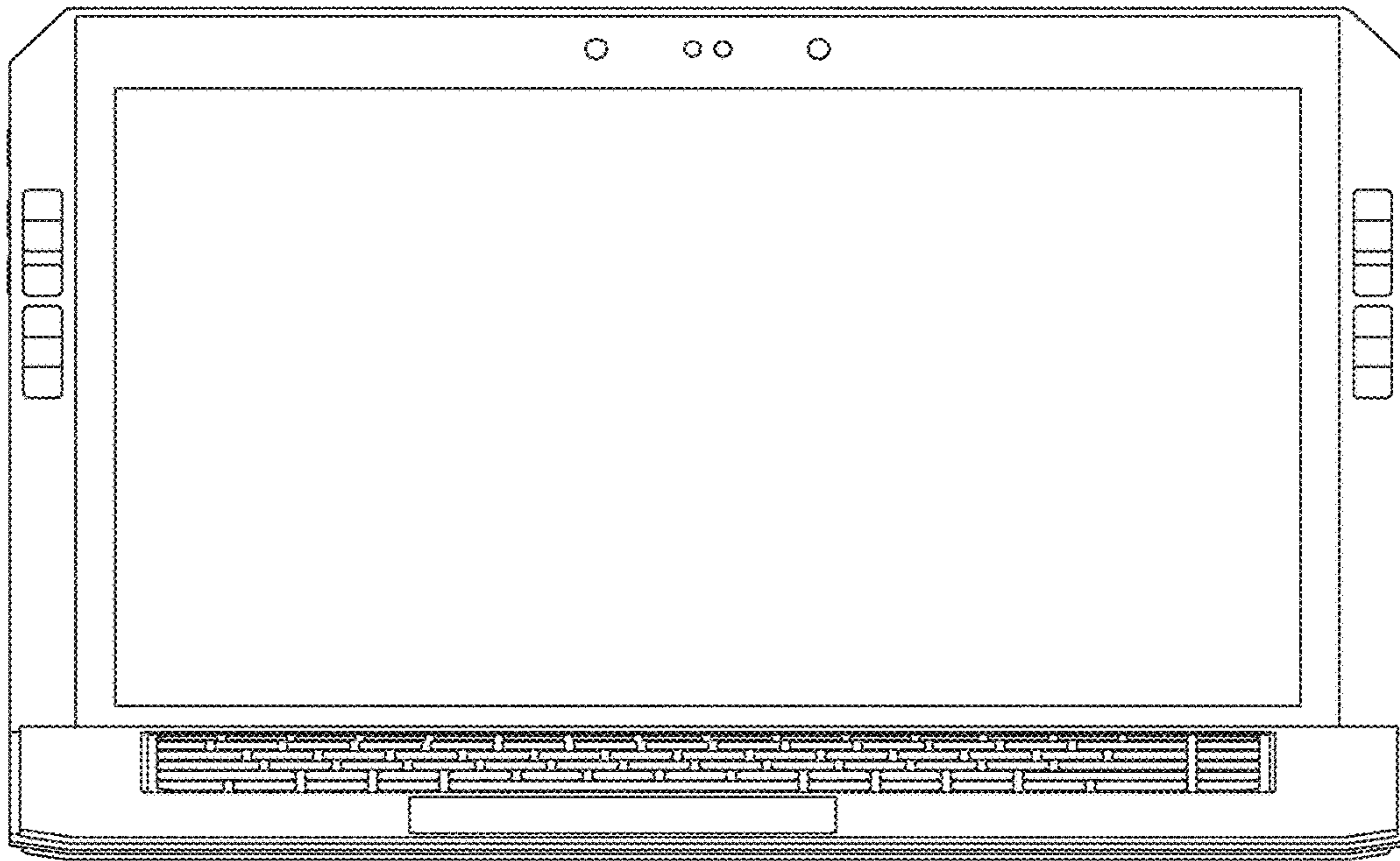

FIG. 9

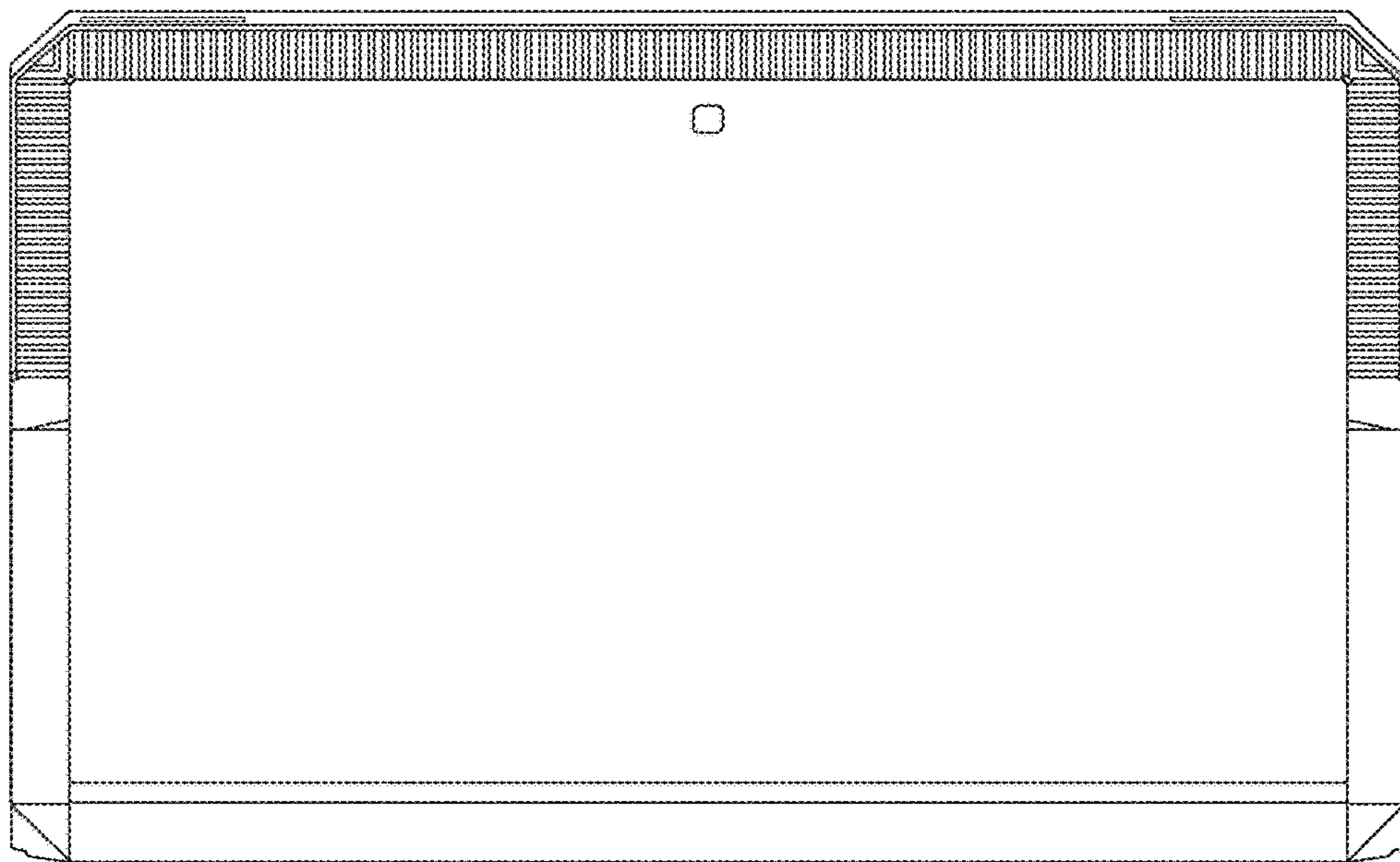

FIG. 10

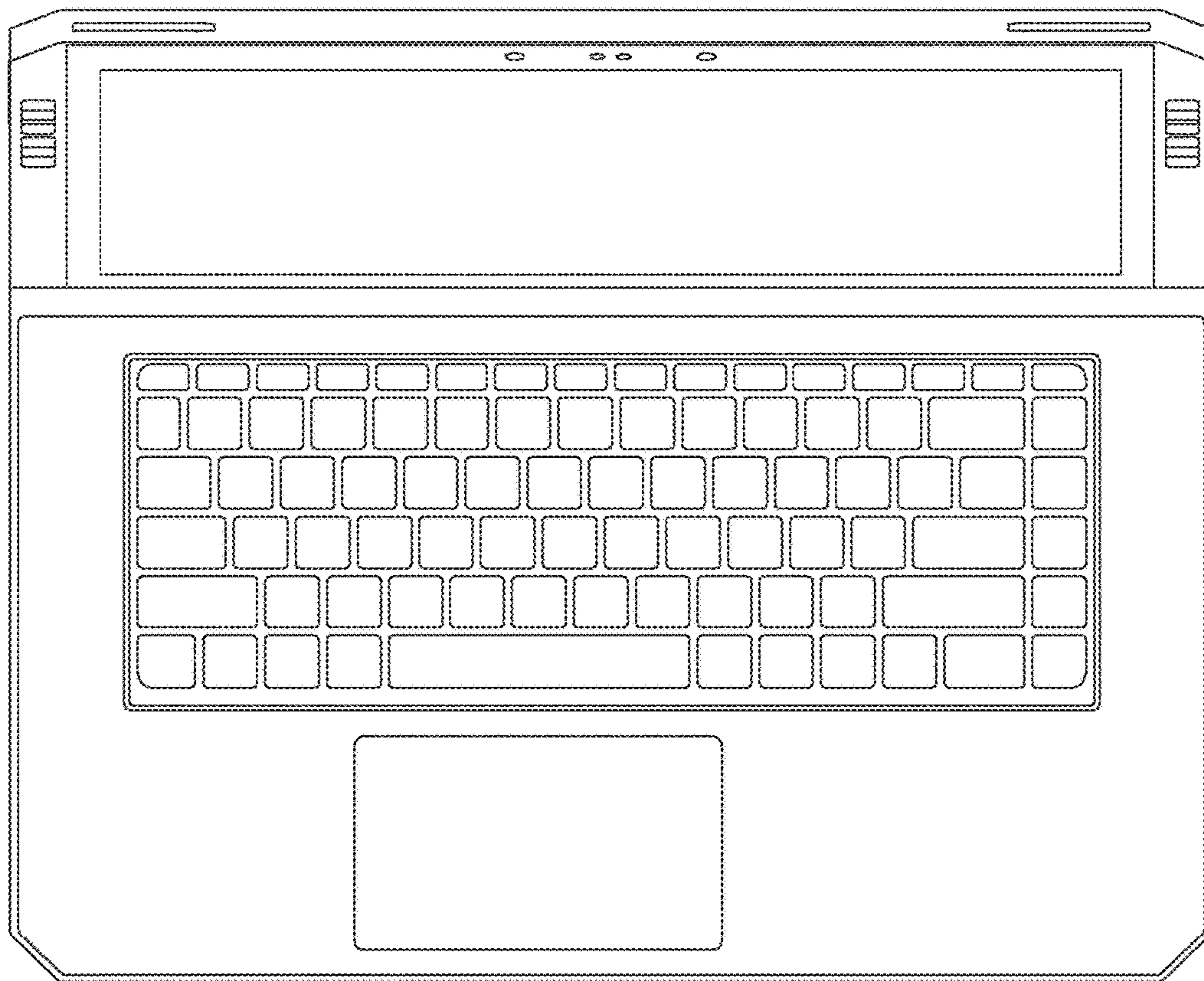

FIG. 11

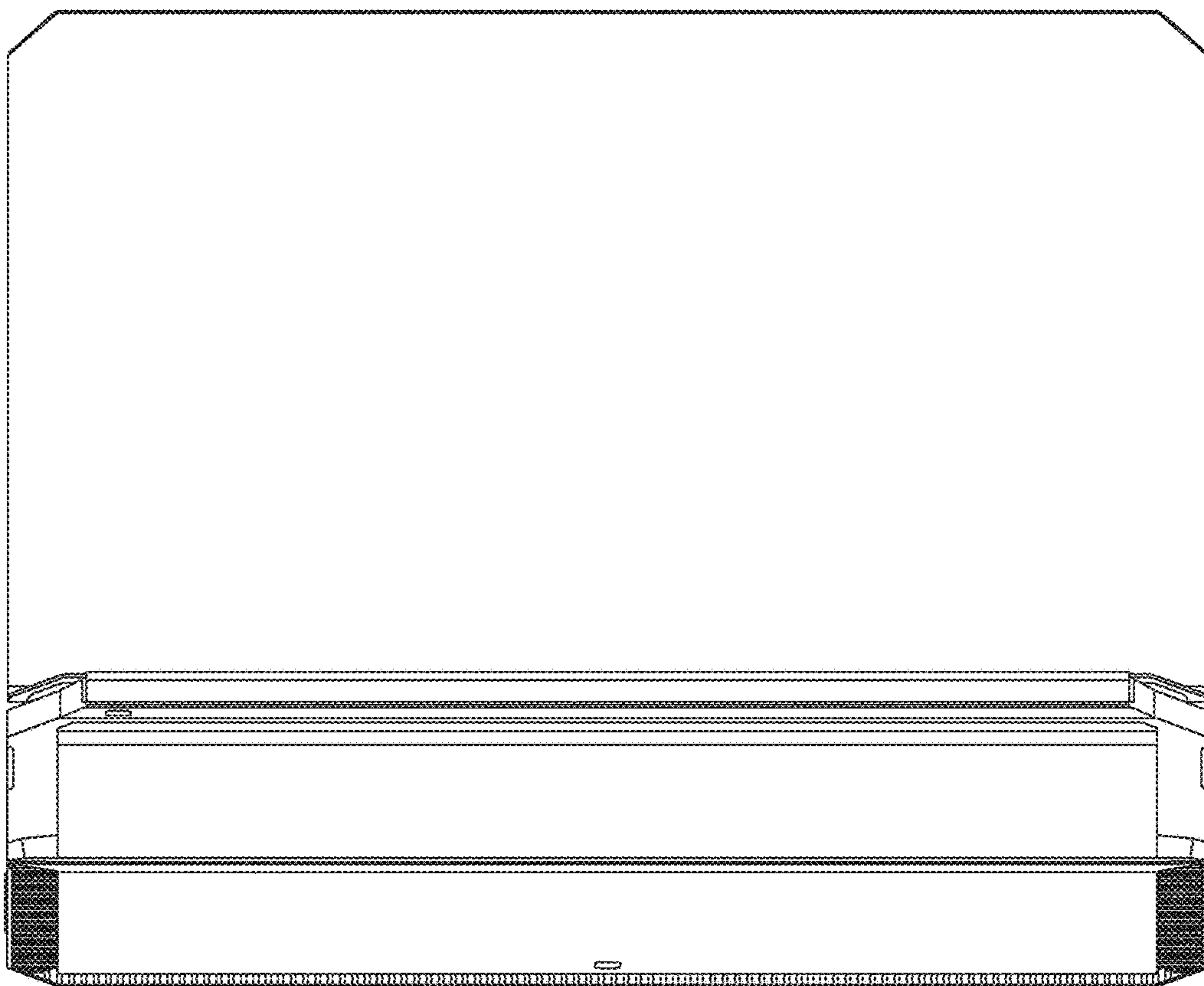

FIG. 12

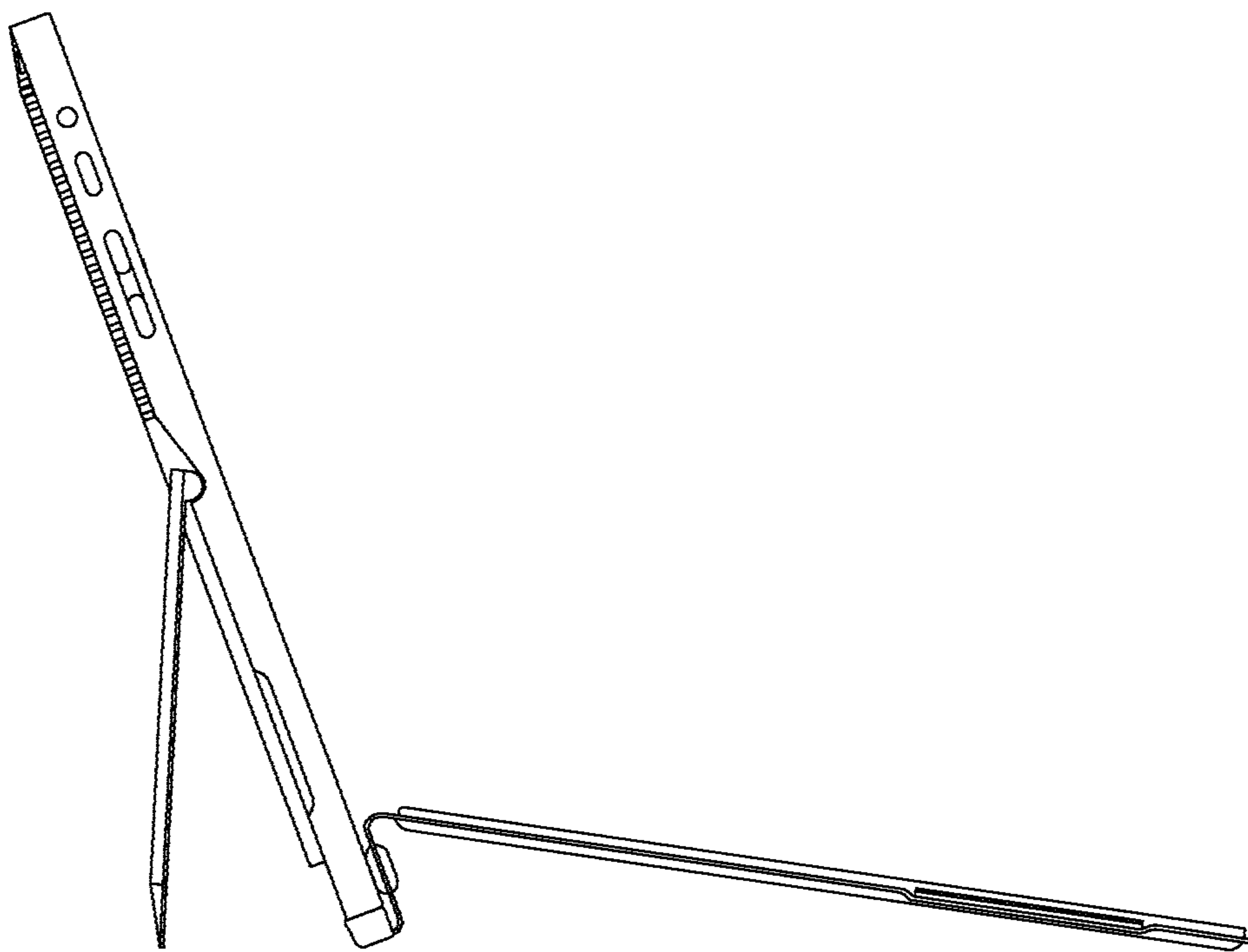

FIG. 13

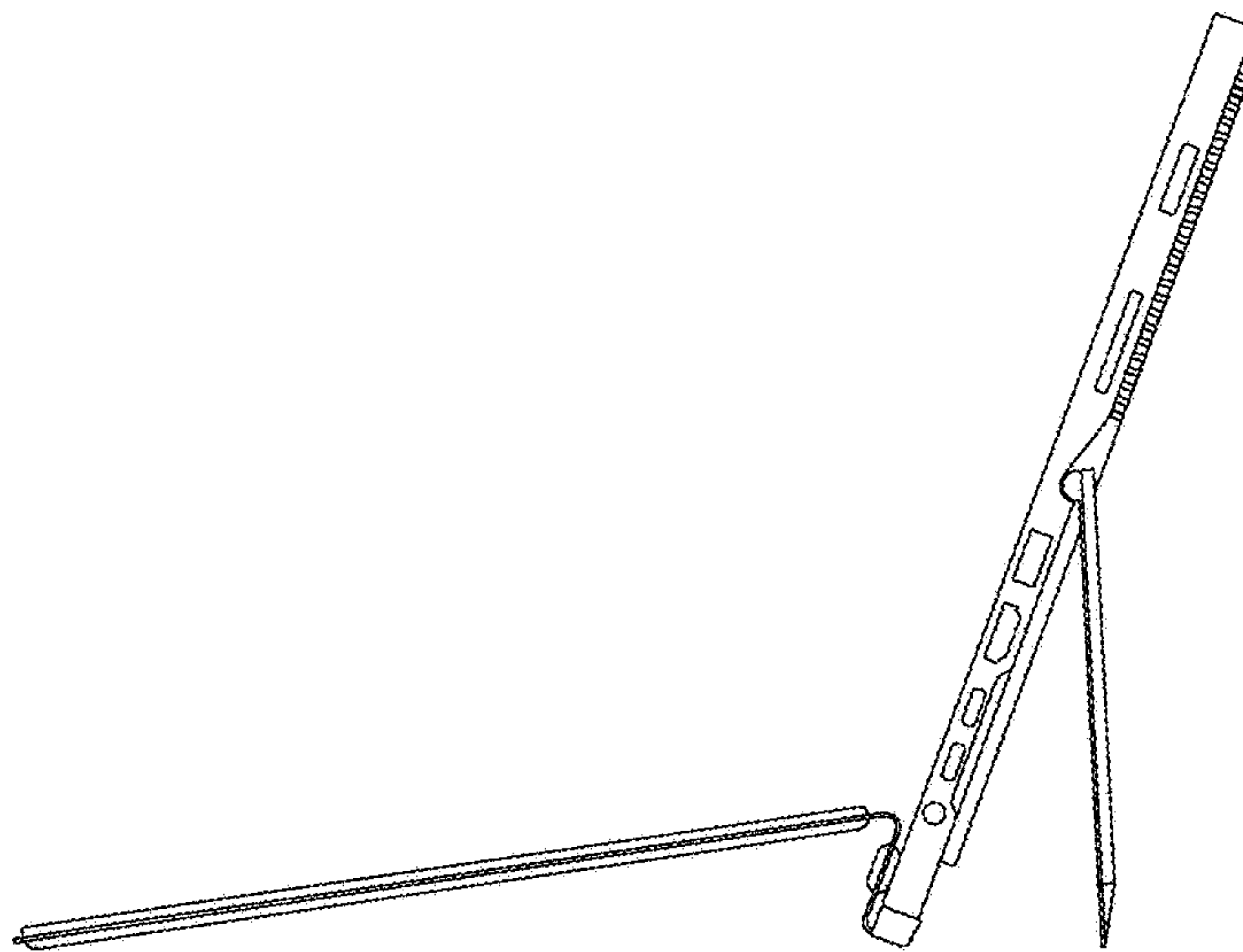

FIG. 14