



US00D789301S

(12) **United States Design Patent** (10) **Patent No.:** **US D789,301 S**
Perez et al. (45) **Date of Patent:** **** Jun. 13, 2017**

(54) **ELECTRICAL DONGLE**
(71) Applicant: **Google Inc.**, Mountain View, CA (US)
(72) Inventors: **Alberto Martin Perez**, Mountain View, CA (US); **Katie Leah Roberts-Hoffman**, San Jose, CA (US); **Hsu Wan Pao**, Taipei (TW)
(73) Assignee: **Google Inc.**, Mountain View, CA (US)
(**) Term: **15 Years**
(21) Appl. No.: **29/532,090**
(22) Filed: **Jul. 1, 2015**
(51) **LOC (10) Cl.** **13-03**
(52) **U.S. Cl.**
USPC **D13/147**
(58) **Field of Classification Search**
USPC D13/133, 146, 147, 154, 184, 199;
D14/432, 433, 435, 435.1, 436, 437, 438
CPC H01R 13/02; H01R 13/03; H01R 13/405;
H01R 13/648; H01R 13/66; H01R 24/00;
H01R 24/28; H01R 43/00
See application file for complete search history.

(56) **References Cited**
U.S. PATENT DOCUMENTS
D572,249 S * 7/2008 Yang D14/435.1
D679,250 S * 4/2013 Choi D13/147
D704,578 S * 5/2014 Chen D10/70
D745,523 S * 12/2015 Magi D14/433
D753,090 S * 4/2016 Langhammer D14/203.3
D760,657 S * 7/2016 Hung D13/147

* cited by examiner

Primary Examiner — Daniel Bui

(74) *Attorney, Agent, or Firm* — Lerner, David, Littenberg, Krumholz & Mentlik, LLP

(57) **CLAIM**
The ornamental design for an electrical dongle, as shown and described.

DESCRIPTION
FIG. 1 is a front perspective view of an electrical dongle according to a first configuration, showing our new design; FIG. 2 is a front elevation view thereof; FIG. 3 is a rear elevation view thereof; FIG. 4 is a right side elevation view thereof; FIG. 5 is a left side elevation view thereof; FIG. 6 is a top plan view thereof; FIG. 7 is a bottom plan view thereof; FIG. 8 is a front perspective view thereof, according to a second configuration; FIG. 9 is a front elevation view thereof; FIG. 10 is a rear elevation view thereof; FIG. 11 is a right side elevation view thereof; FIG. 12 is a left side elevation view thereof; FIG. 13 is a top plan view thereof; FIG. 14 is a bottom plan view thereof; FIG. 15 is a front perspective view thereof, according to a third configuration; FIG. 16 is a front elevation view thereof; FIG. 17 is a rear elevation view thereof; FIG. 18 is a right side elevation view thereof; FIG. 19 is a left side elevation view thereof; FIG. 20 is a top plan view thereof; and, FIG. 21 is a bottom plan view thereof.
The broken line shown in the drawing views represents unclaimed environmental only and forms no part of the claimed design.

1 Claim, 11 Drawing Sheets

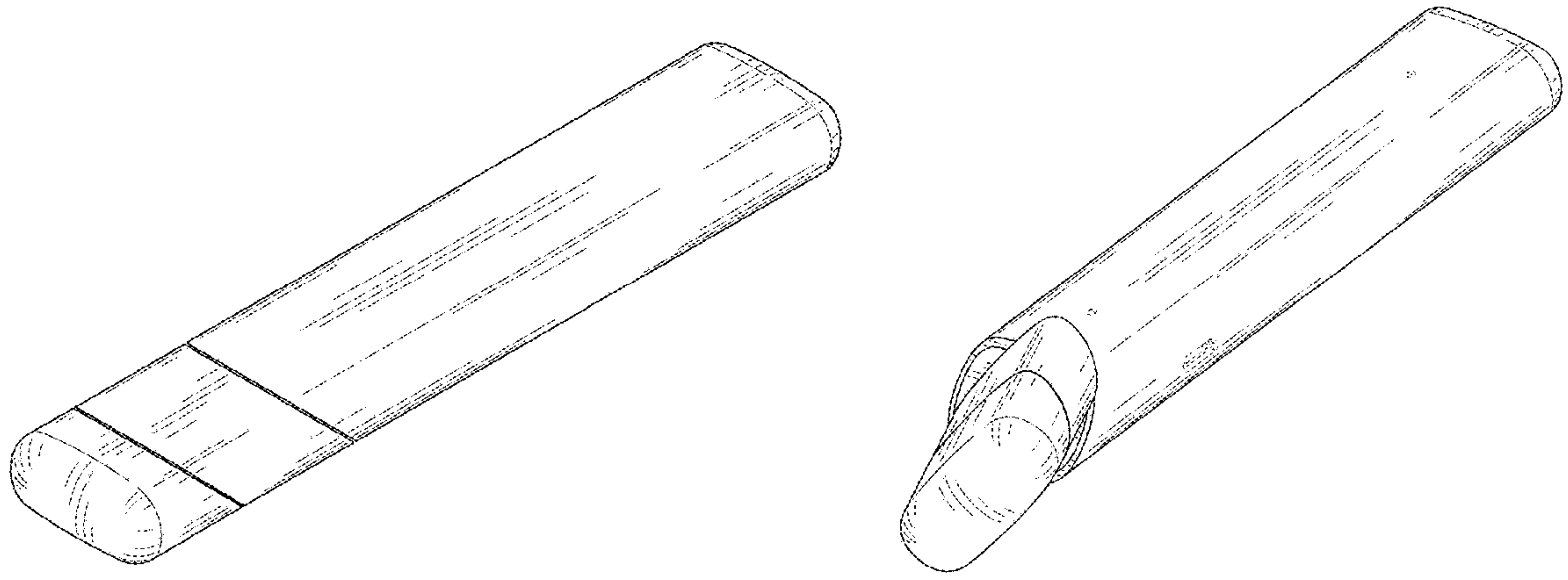

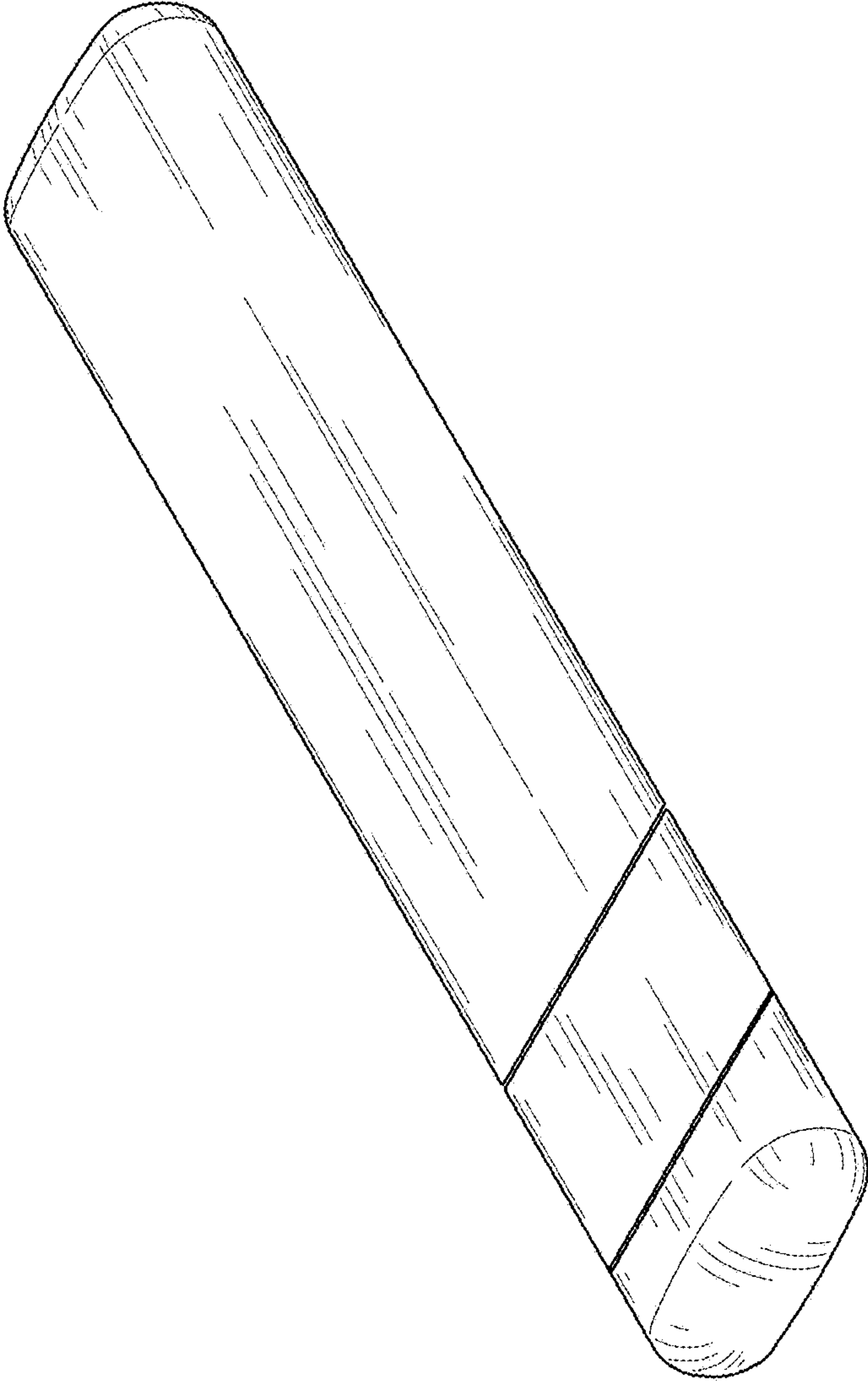

FIG. 1

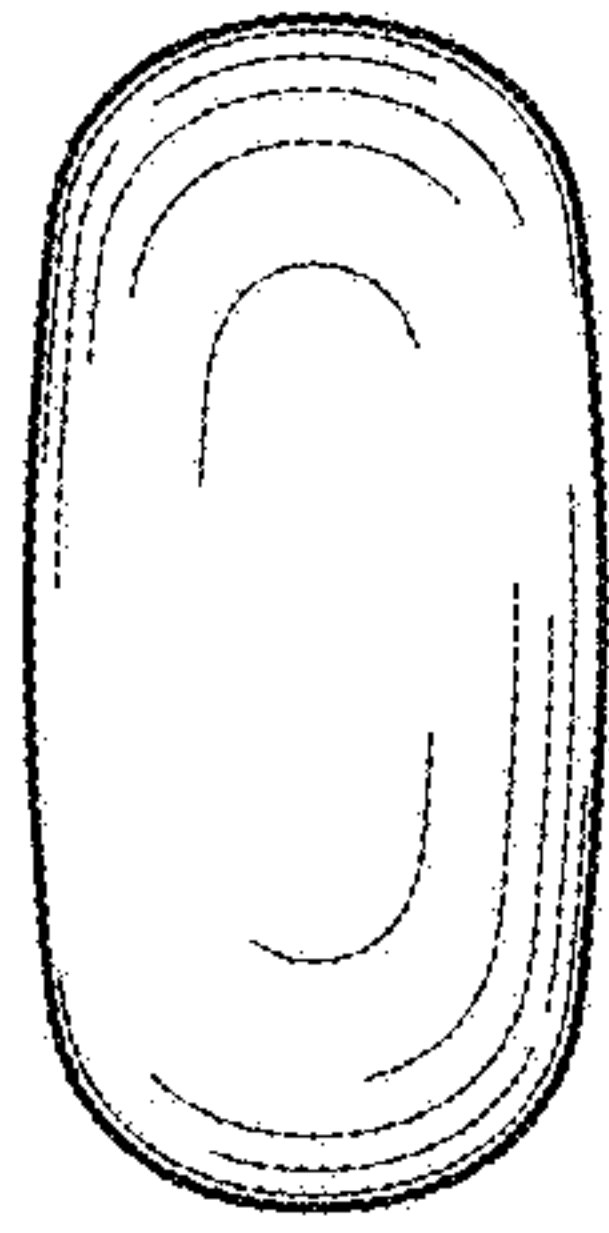

FIG. 2

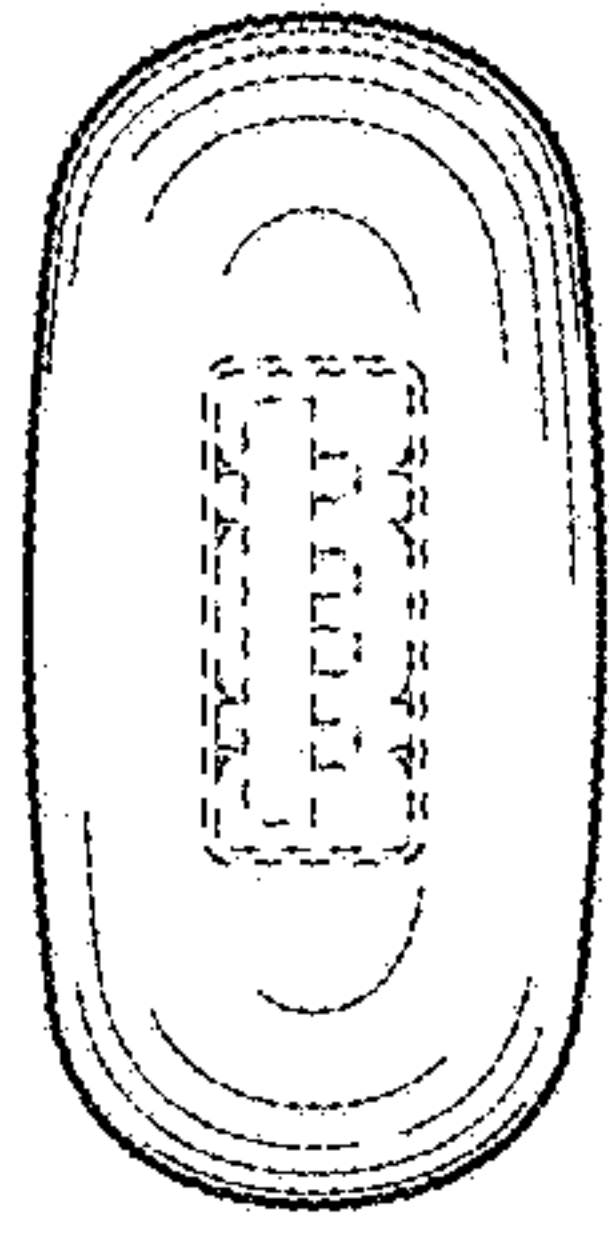

FIG. 3

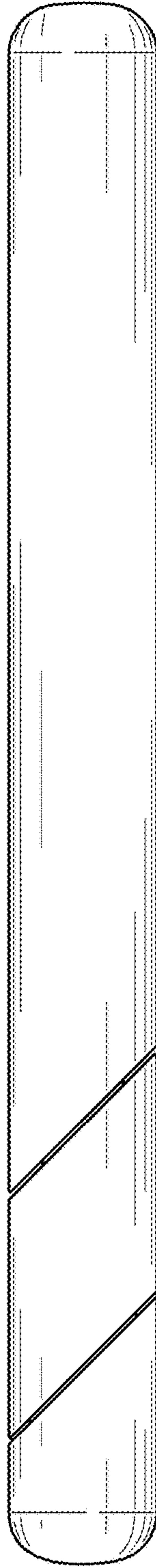

FIG. 4

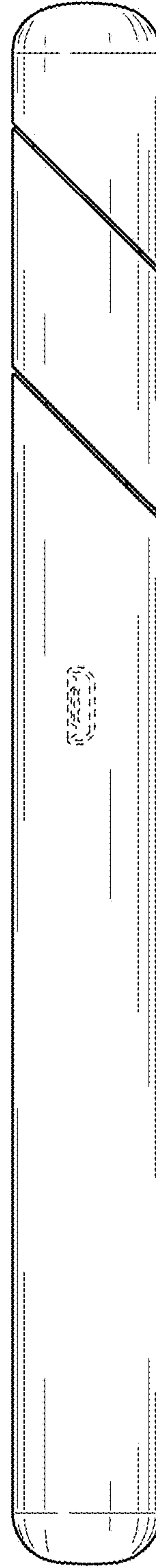

FIG. 5

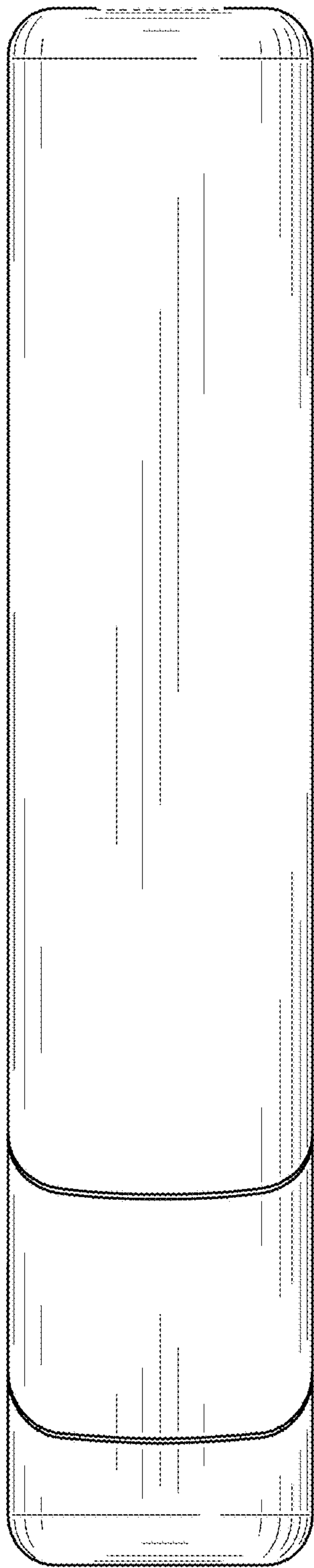

FIG. 6

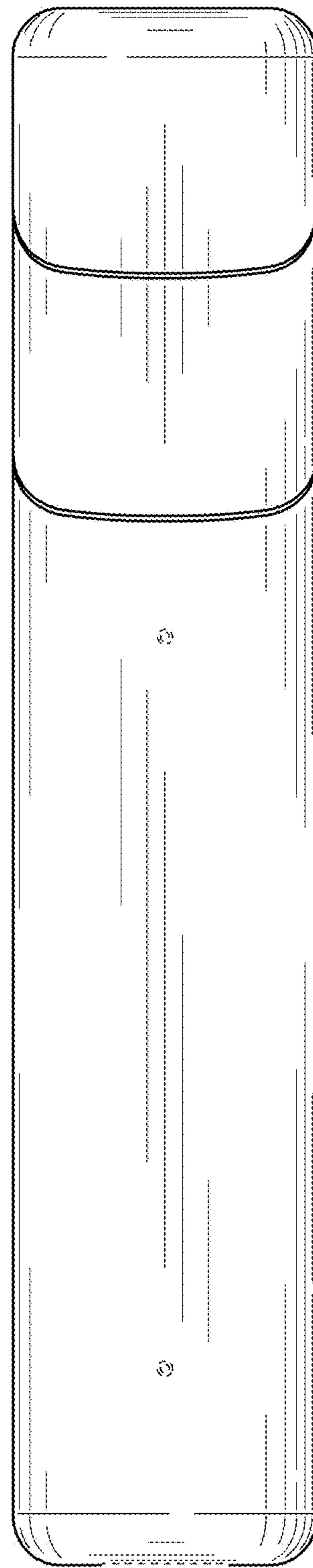

FIG. 7

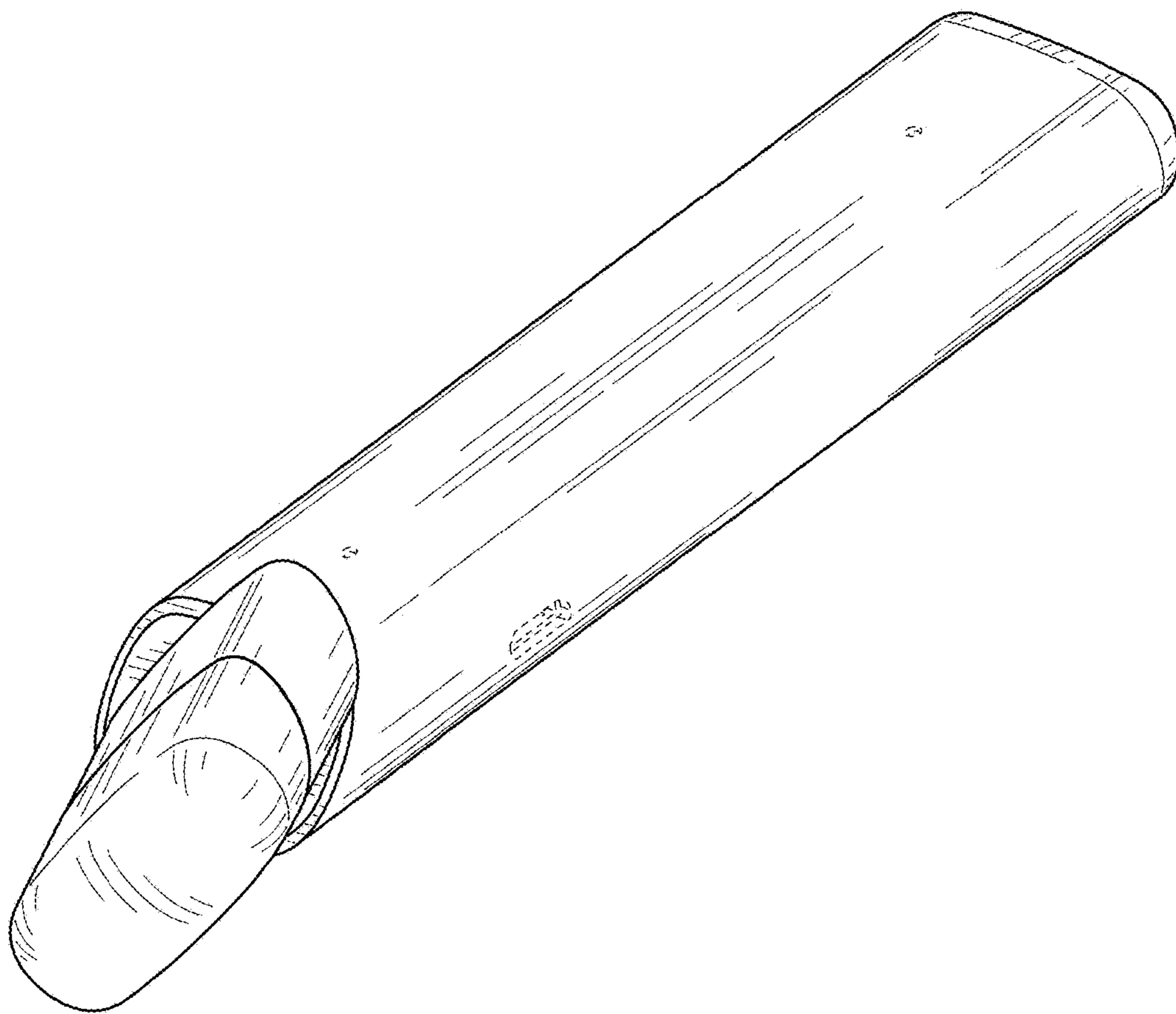

FIG. 8

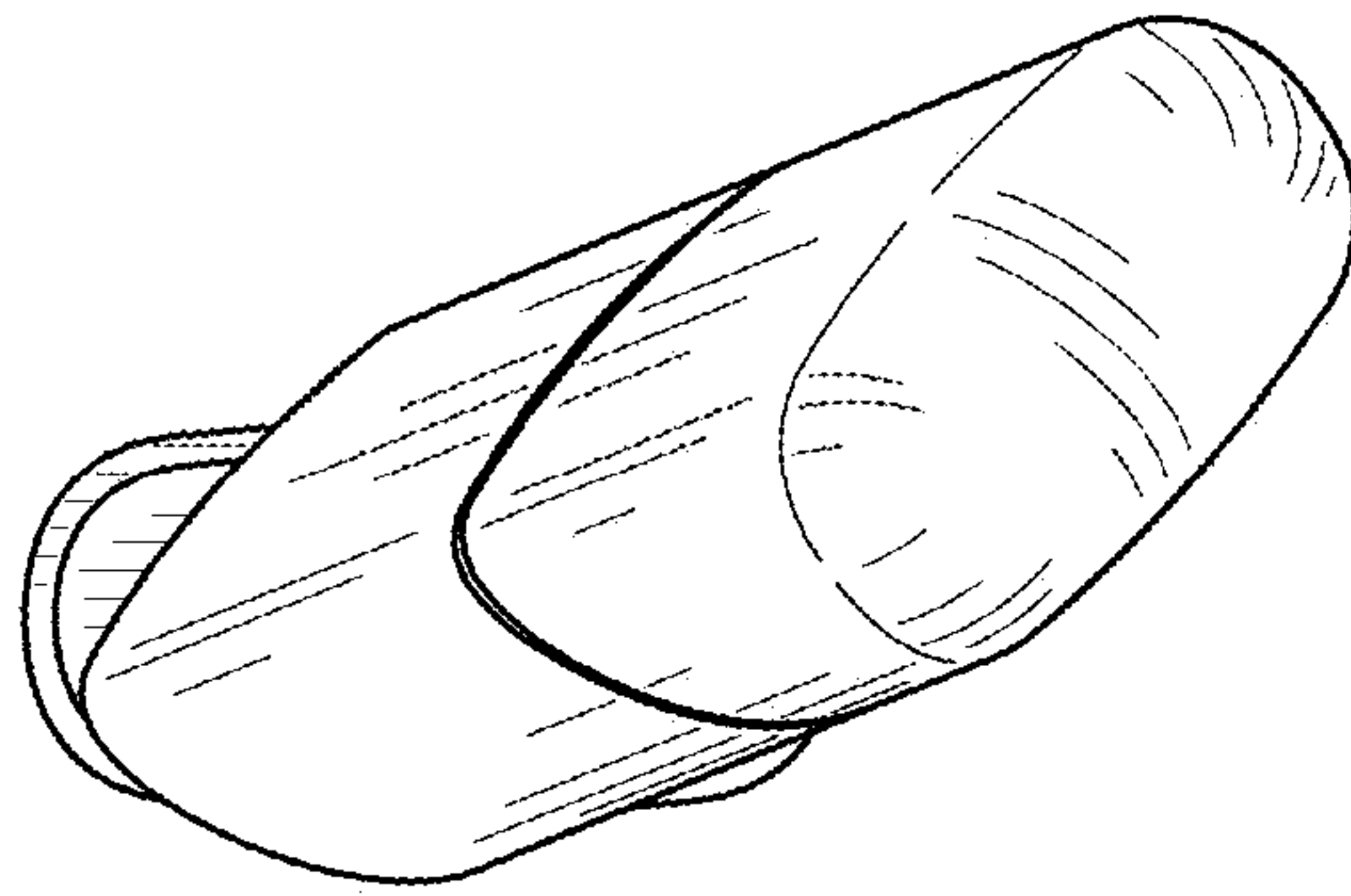

FIG. 9

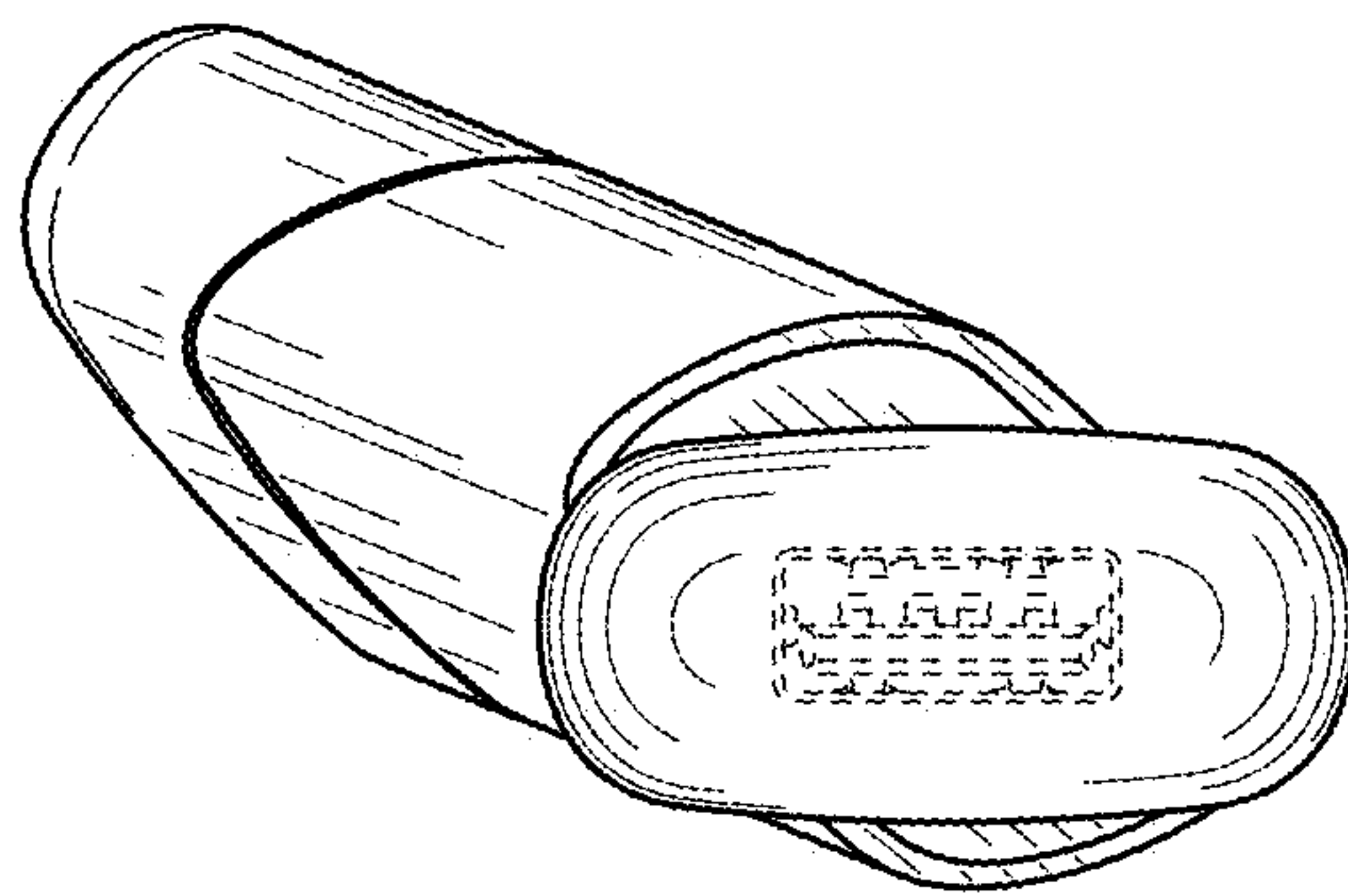

FIG. 10

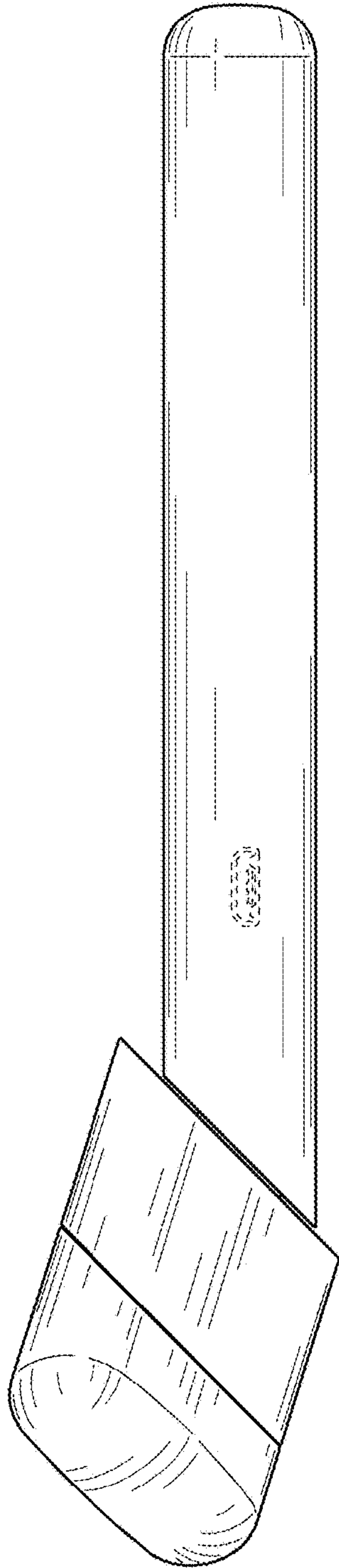

FIG. 11

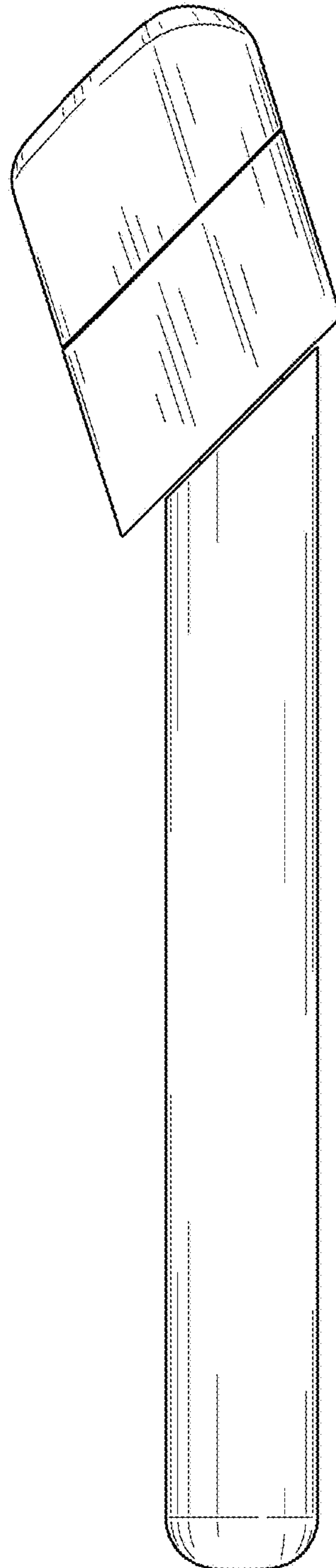

FIG. 12

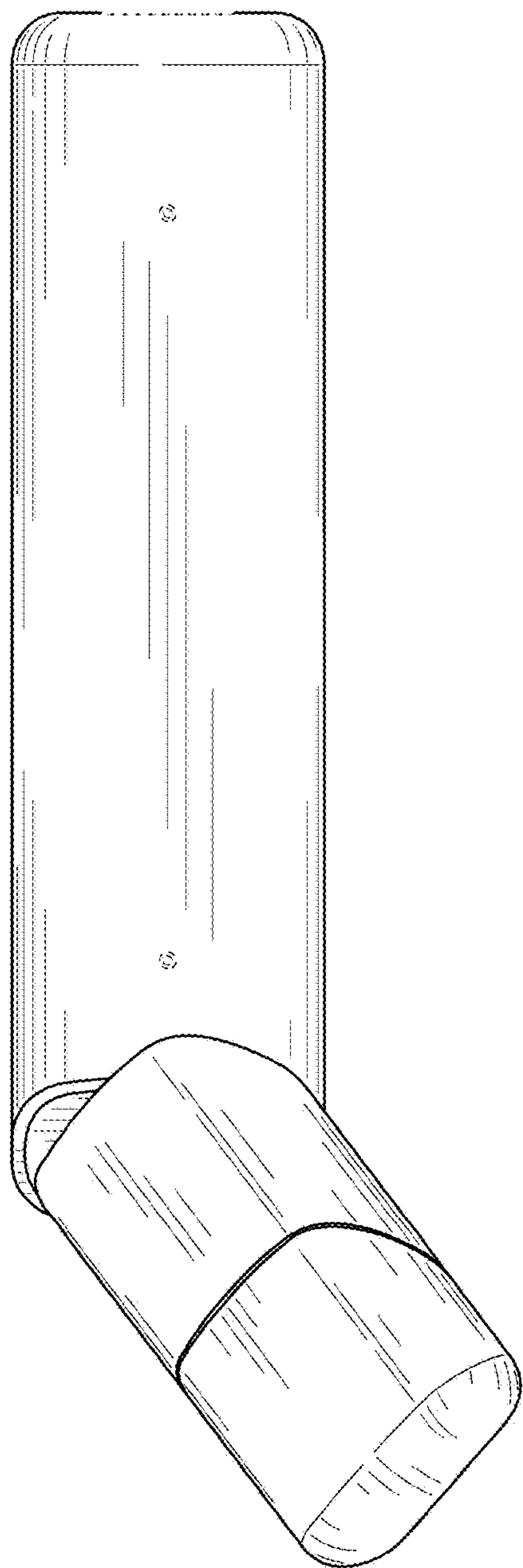

FIG. 13

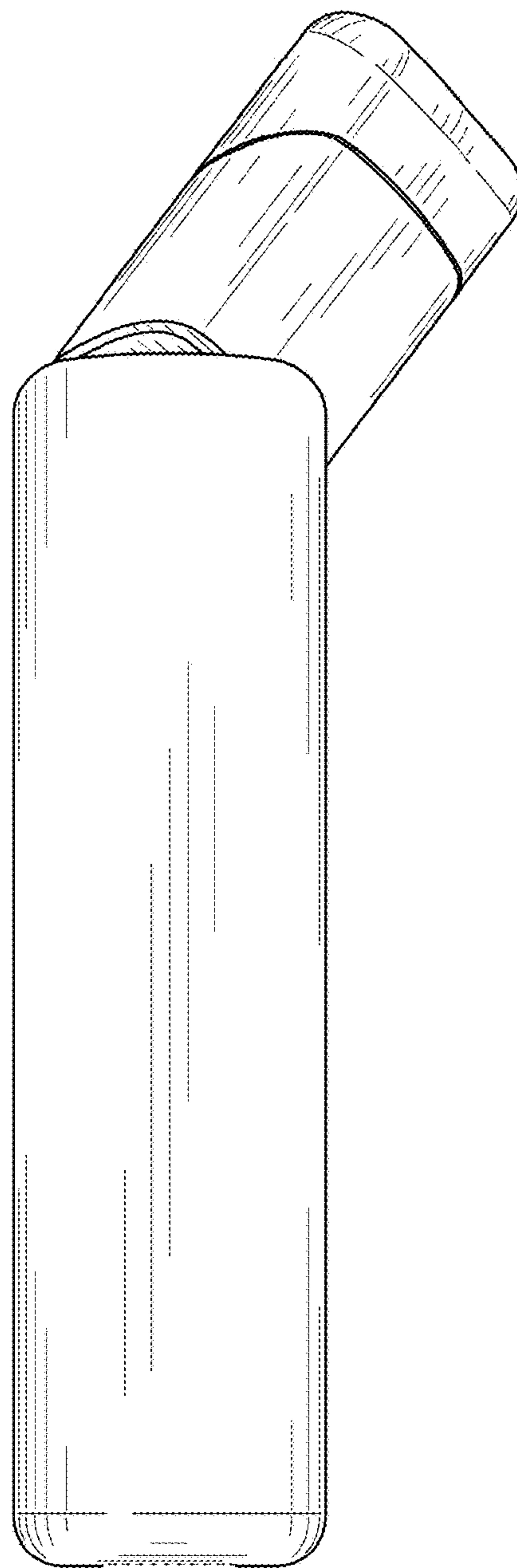

FIG. 14

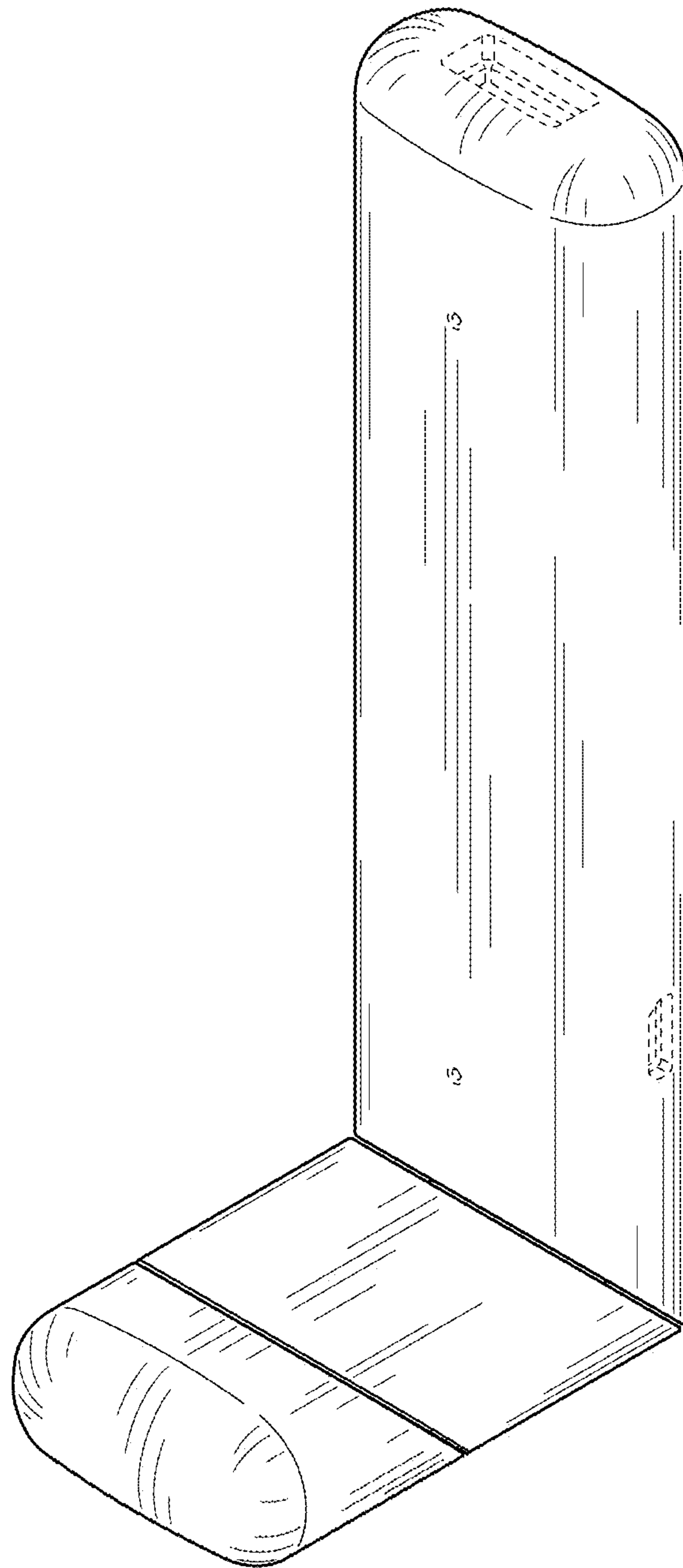

FIG. 15

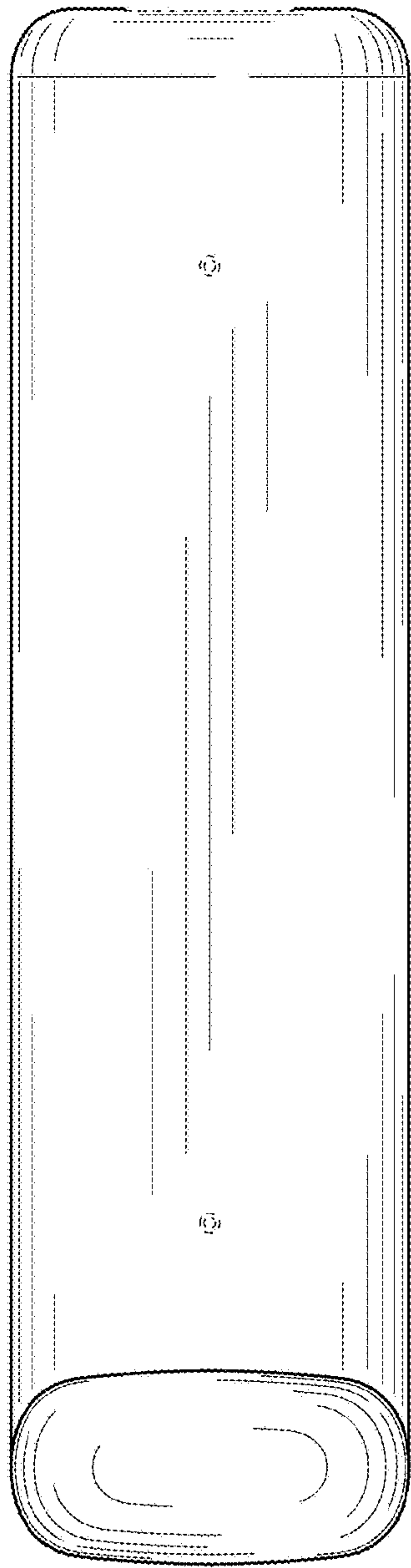

FIG. 16

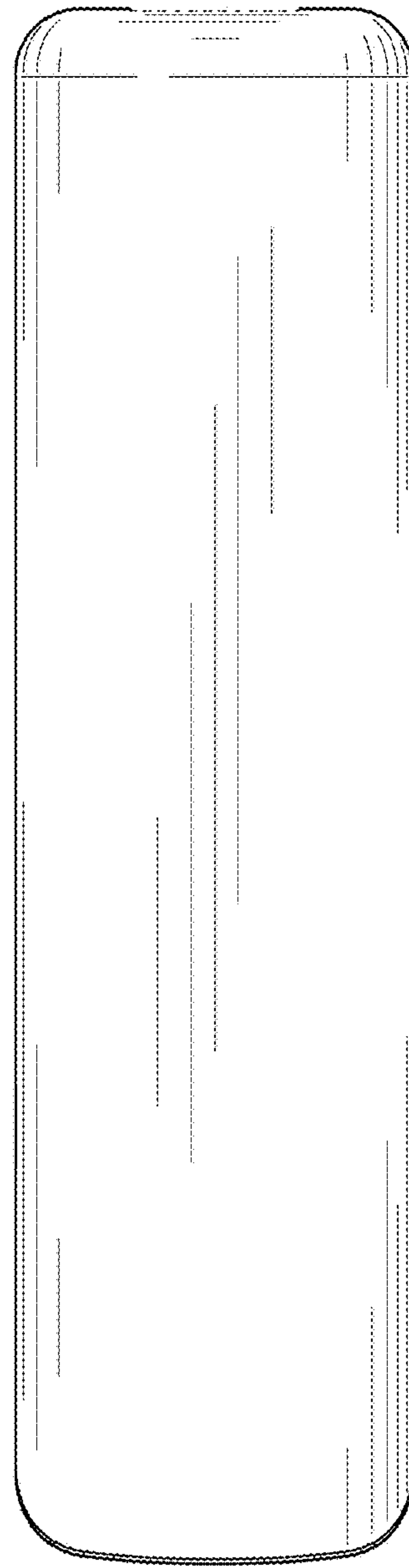

FIG. 17

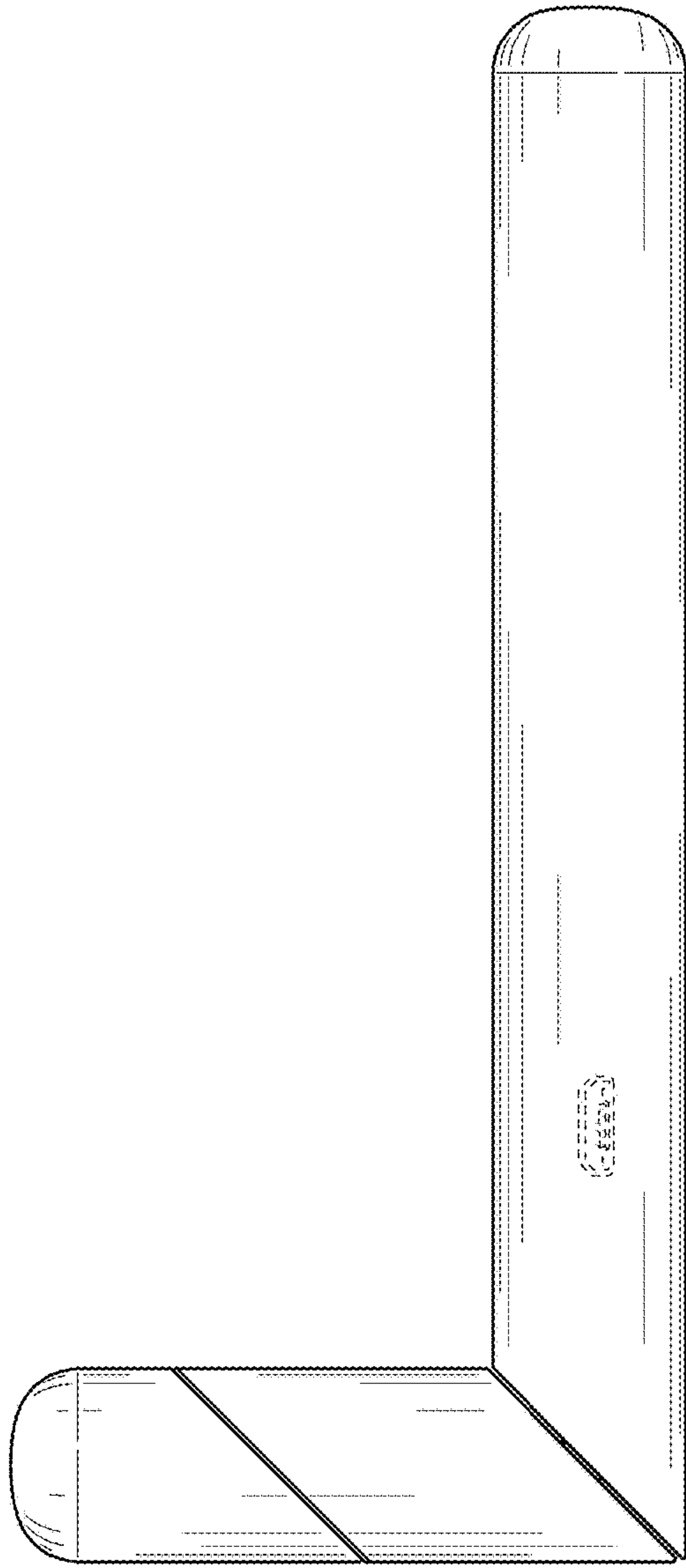

FIG. 18

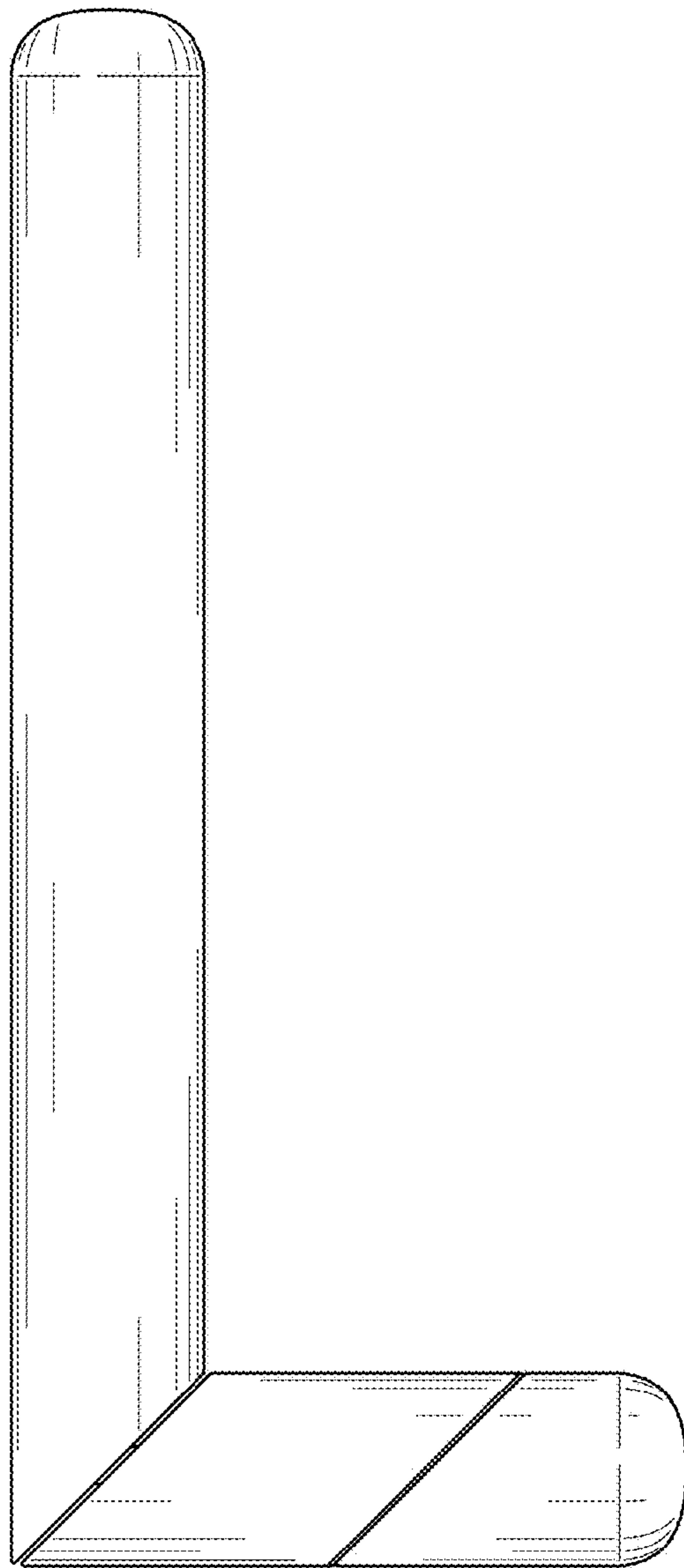

FIG. 19

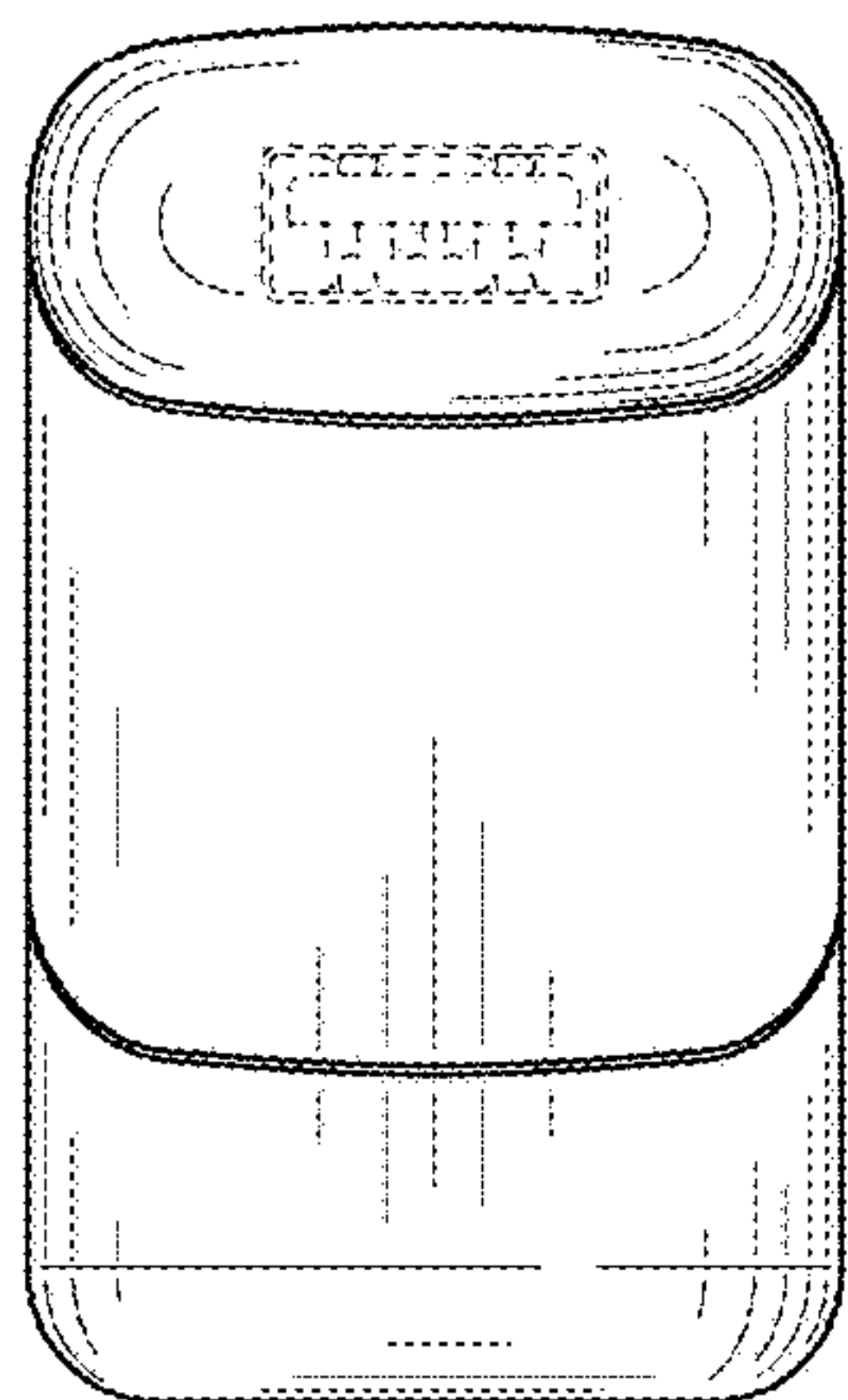

FIG. 20

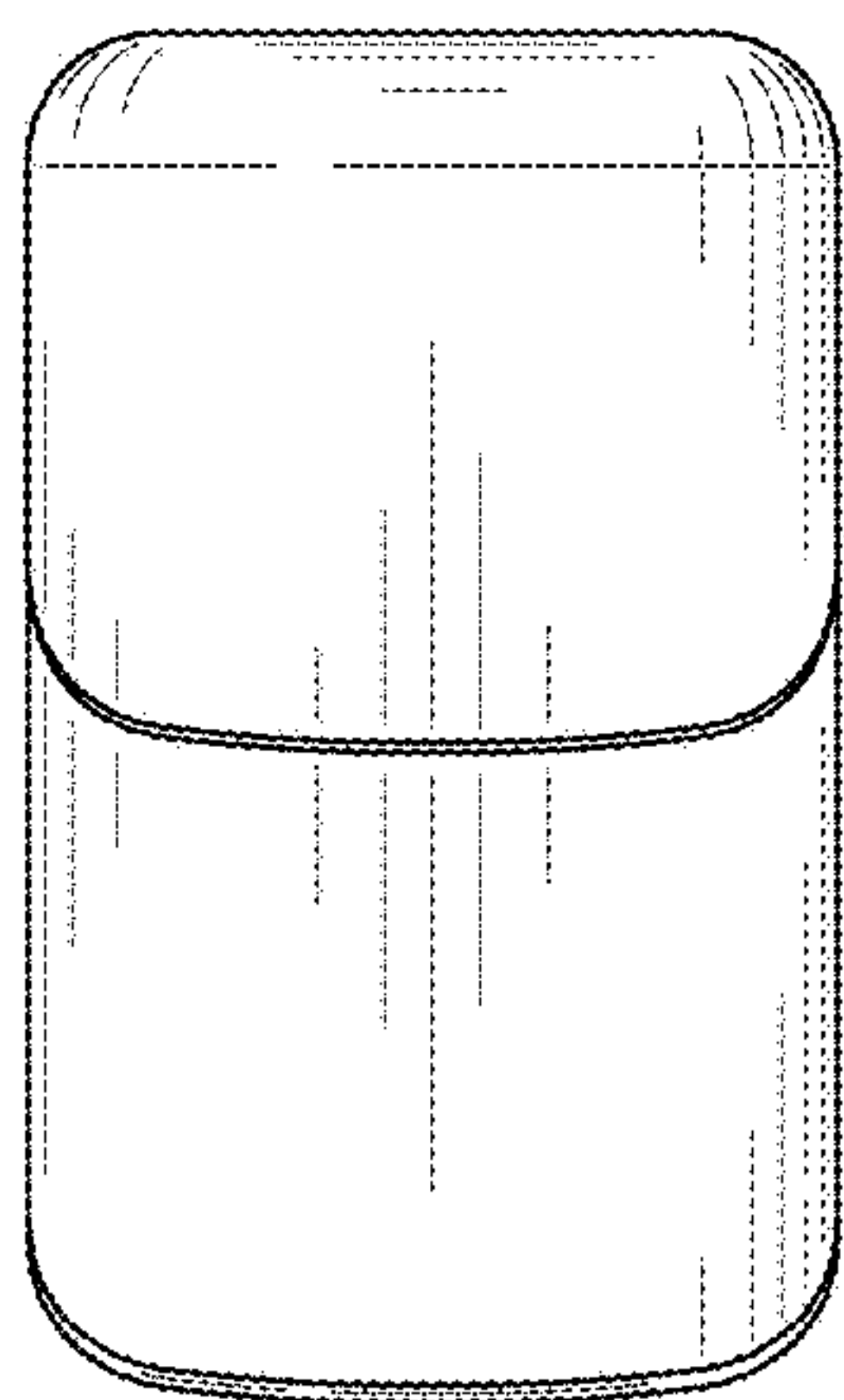

FIG. 21