

US00D789135S

(12) **United States Design Patent**
Green

(10) **Patent No.:** **US D789,135 S**

(45) **Date of Patent:** **** Jun. 13, 2017**

- (54) **WATER PITCHER**
- (71) Applicant: **Brita LP**, Oakland, CA (US)
- (72) Inventor: **Brett Z. Green**, Pleasanton, CA (US)
- (73) Assignee: **Brita LP**, Oakland, CA (US)
- (**) Term: **15 Years**
- (21) Appl. No.: **29/536,091**
- (22) Filed: **Aug. 13, 2015**
- (51) **LOC (10) Cl.** **07-01**
- (52) **U.S. Cl.**
USPC **D7/318**; D7/317
- (58) **Field of Classification Search**
USPC D7/316–319.31, 312, 598, 600, 322, 536,
D7/507, 394, 398; 222/188, 465.1, 713;
D23/209; D8/320
CPC A47J 41/0027; A47J 31/50; A47J 45/0077;
A47J 31/053; A47J 31/20; A47J 31/02;
A47J 45/10; A47J 31/14; A47J 411/02;
A47G 19/22; A47G 19/12
See application file for complete search history.

(56) **References Cited**

U.S. PATENT DOCUMENTS

- 3,189,937 A * 6/1965 Sciortino A47G 23/0266
294/33
- 3,261,635 A * 7/1966 Talay A47G 23/0266
215/396
- D220,773 S * 5/1971 Dilyard D7/317
- D229,012 S * 11/1973 Wooters 222/465.1
- 4,653,671 A * 3/1987 Duffy A47G 23/0258
215/322
- D312,551 S * 12/1990 DeCoster D7/319
- D323,874 S 2/1992 Hirman et al.
- D331,446 S 12/1992 Gidman
- D336,760 S 6/1993 Raunkjaer

- D345,669 S 4/1994 Piret
- D356,004 S 3/1995 Valkenburg et al.
- D379,932 S * 6/1997 Trussardi D9/544
- D383,351 S * 9/1997 DeMore D7/317
- D386,041 S 11/1997 Tanner et al.
- D388,654 S 1/1998 Bouhuys
- D388,655 S 1/1998 Flom et al.
- D389,004 S 1/1998 Hampshire et al.
- D389,006 S 1/1998 Demore et al.
- D398,184 S 9/1998 Silverberg et al.
- D400,392 S 11/1998 Robertson et al.
- D406,003 S 2/1999 Tanner et al.
- D415,922 S 11/1999 Kawasaki et al.
- D416,163 S 11/1999 Doritty et al.
- D418,714 S 1/2000 Fox et al.
- D421,361 S 3/2000 Coulson et al.
- 6,103,114 A * 8/2000 Tanner C02F 1/003
210/232
- D436,294 S * 1/2001 Marck D7/511
- D437,175 S 2/2001 Brady
- D439,790 S * 4/2001 Matsushita D7/317
- D440,110 S 4/2001 Tanner et al.

(Continued)

Primary Examiner — Marianne Pandozzi
(74) *Attorney, Agent, or Firm* — Stacy H. Combs;
Thomas C. Feix

(57) **CLAIM**

The ornamental design for a water pitcher, as shown and described.

DESCRIPTION

FIG. 1 is a top perspective view of a water pitcher showing my new design;
FIG. 2 is a top view thereof;
FIG. 3 is a bottom view thereof;
FIG. 4 is a left side view thereof,
FIG. 5 is a right side view thereof,
FIG. 6 is a front view thereof; and,
FIG. 7 is a rear view thereof.

1 Claim, 5 Drawing Sheets

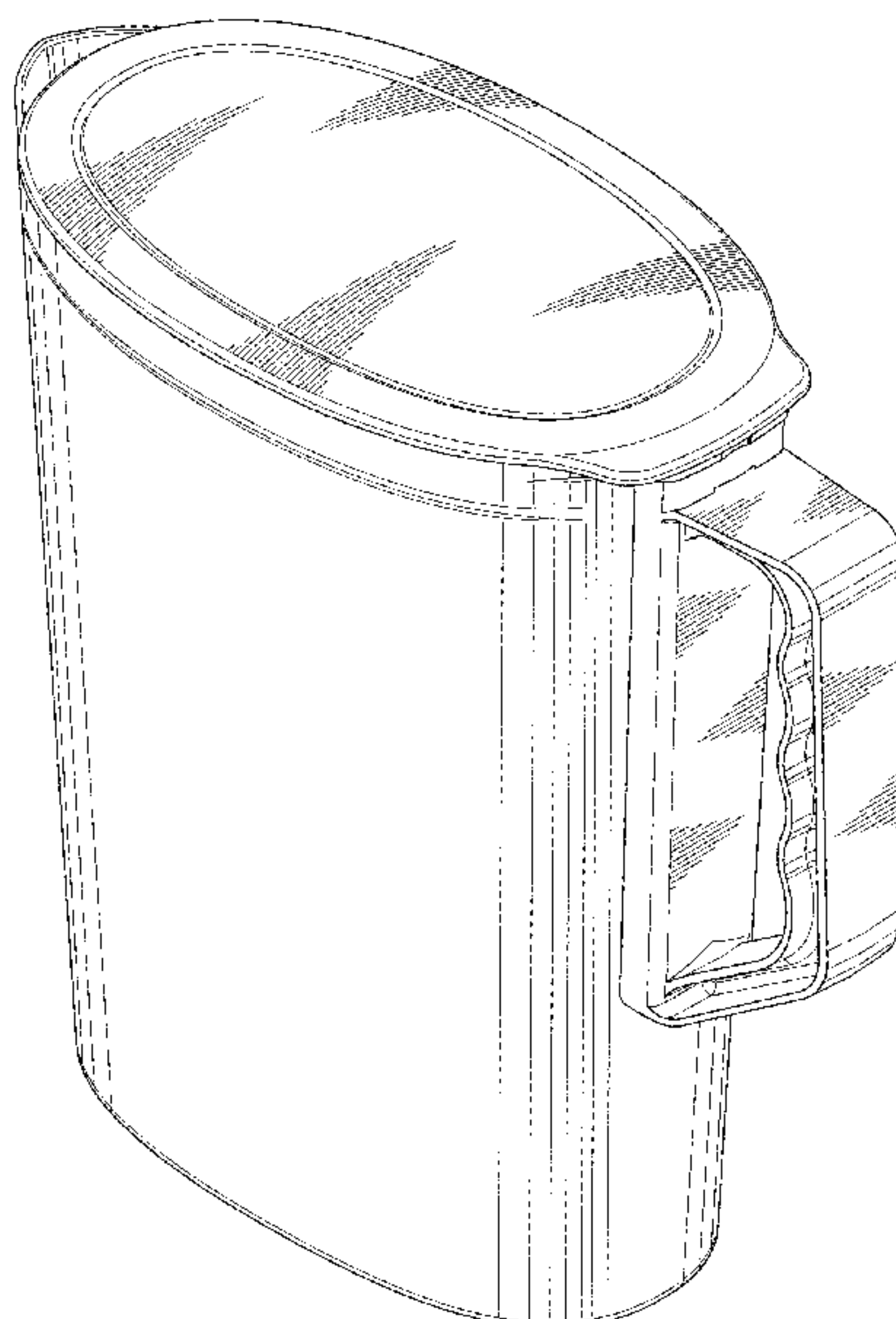

(56)

References Cited

U.S. PATENT DOCUMENTS

6,231,226 B1 *	5/2001	Neidigh	A47G 19/12 366/256
D444,662 S	7/2001	McGrath et al.	
D444,843 S	7/2001	Hilgers et al.	
D444,987 S	7/2001	McGrath et al.	
D445,293 S	7/2001	Lillelund et al.	
D459,941 S	7/2002	Miller	
D460,311 S	7/2002	Chang	
D463,706 S	10/2002	Lecerf	
D465,377 S	11/2002	Murison et al.	
D497,195 S	10/2004	Nishi et al.	
D497,515 S *	10/2004	Bydalek	D7/394
D498,638 S *	11/2004	Morrison	D7/318
D520,597 S	5/2006	Witte	
D523,280 S	6/2006	Bertulis	
D524,087 S	7/2006	Ali	
D546,113 S	7/2007	Ruoff	
D583,612 S	12/2008	Wu	
D584,913 S *	1/2009	Green	D7/317
D585,231 S *	1/2009	Bulala	D7/317
D587,958 S	3/2009	Schosser	
D604,088 S *	11/2009	Bursztein	D7/317
D616,694 S *	6/2010	Kulikov	D23/209
D668,094 S *	10/2012	Broen	D7/317
D675,861 S *	2/2013	Gray	D7/317
D680,791 S *	4/2013	Bell	D7/317
9,049,951 B2 *	6/2015	Keys	A47G 19/12
D740,916 S *	10/2015	Doi	D23/207
D770,010 S *	10/2016	Poindexter	D23/209
D772,635 S *	11/2016	Zhu	D7/317
D773,013 S *	11/2016	Poindexter	D23/209
D774,622 S *	12/2016	Poindexter	D23/209
D775,711 S *	1/2017	Poindexter	D23/209

* cited by examiner

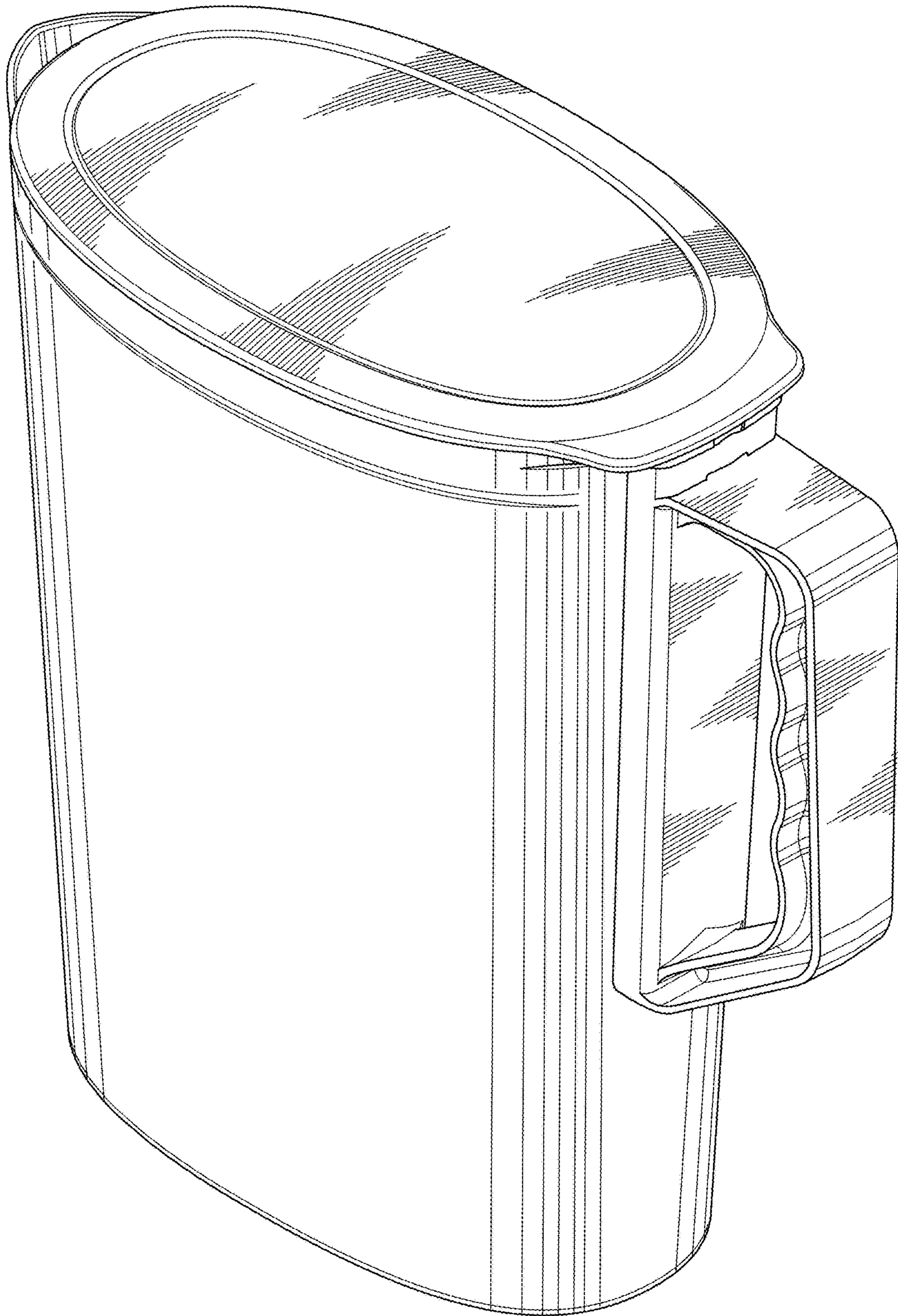

FIG. 1

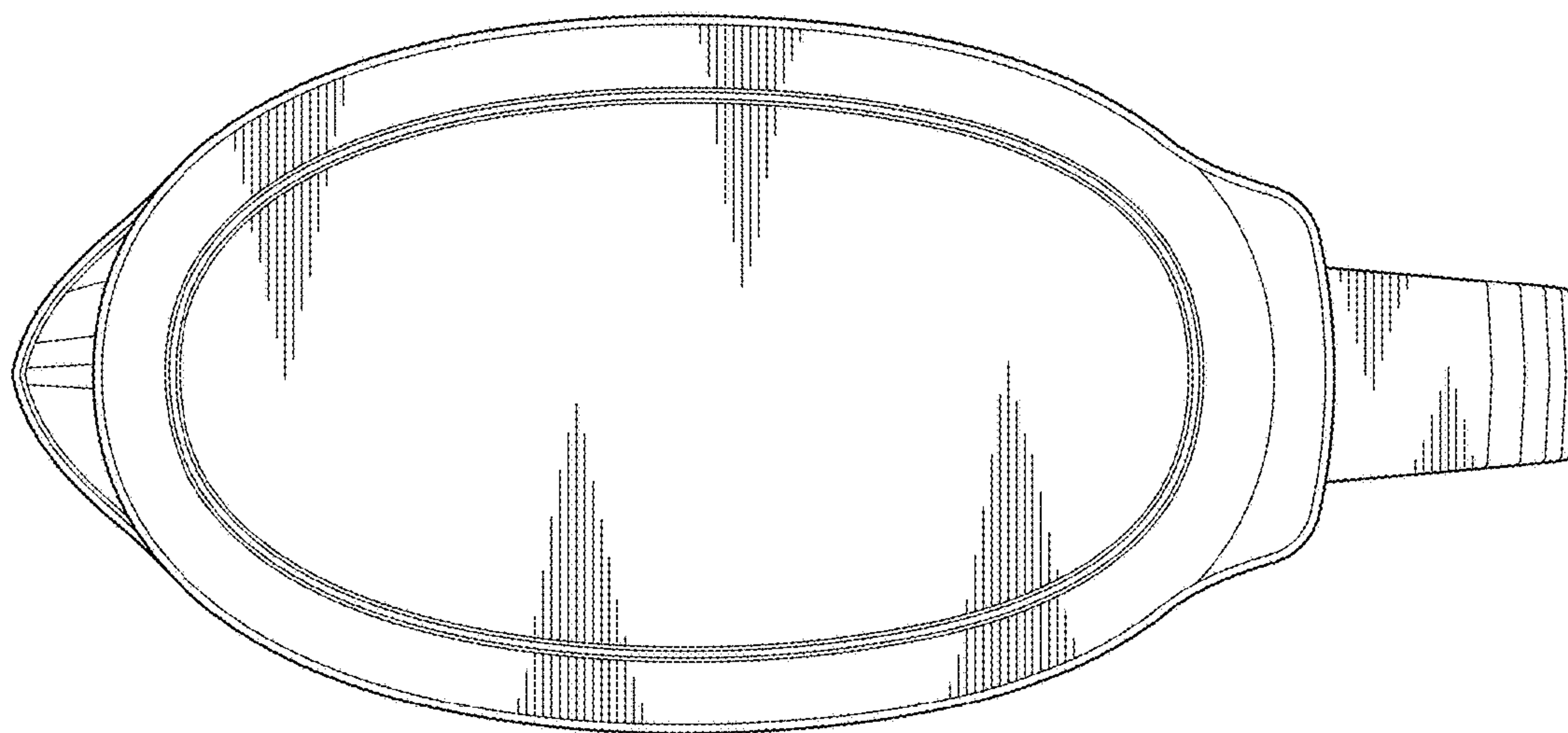

FIG. 2

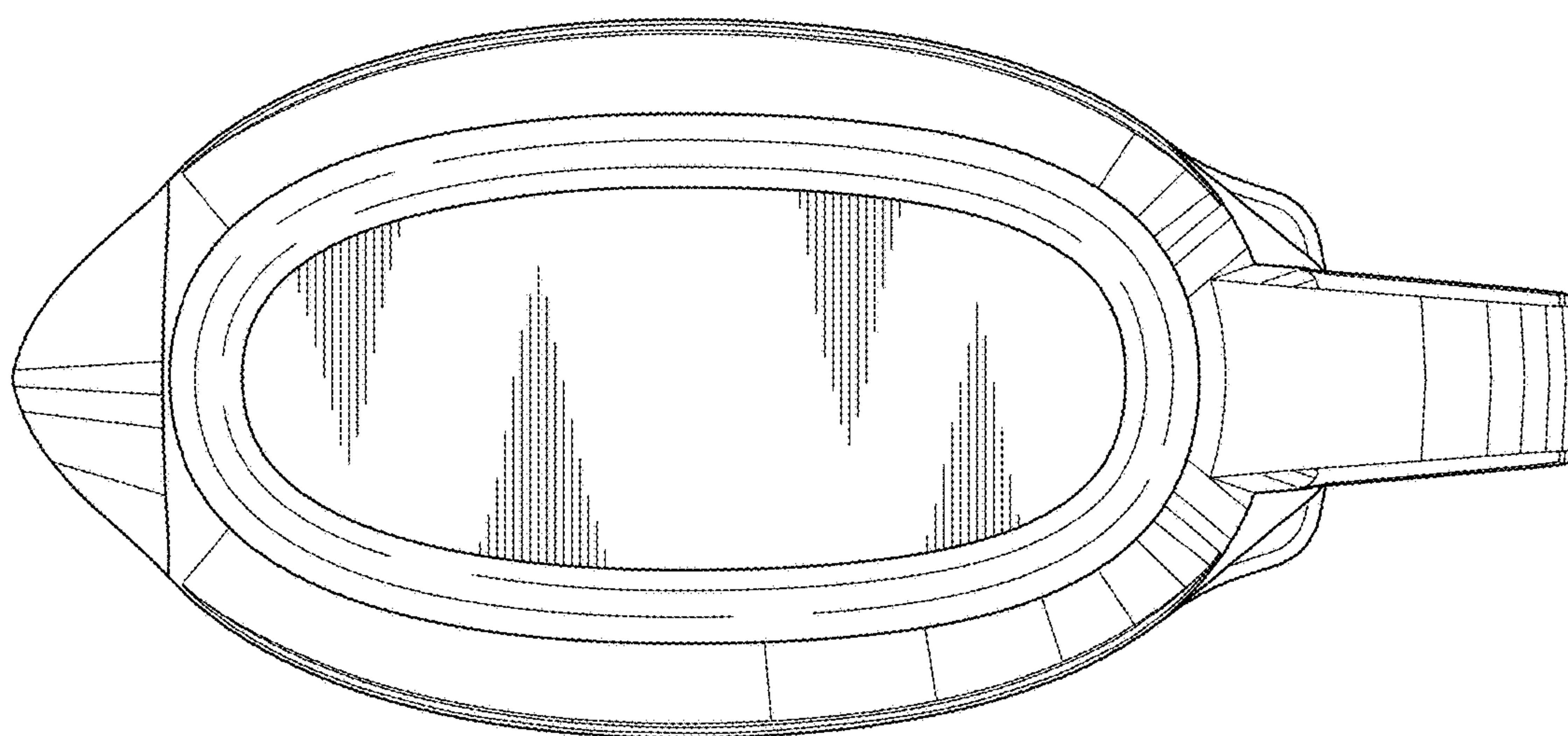

FIG. 3

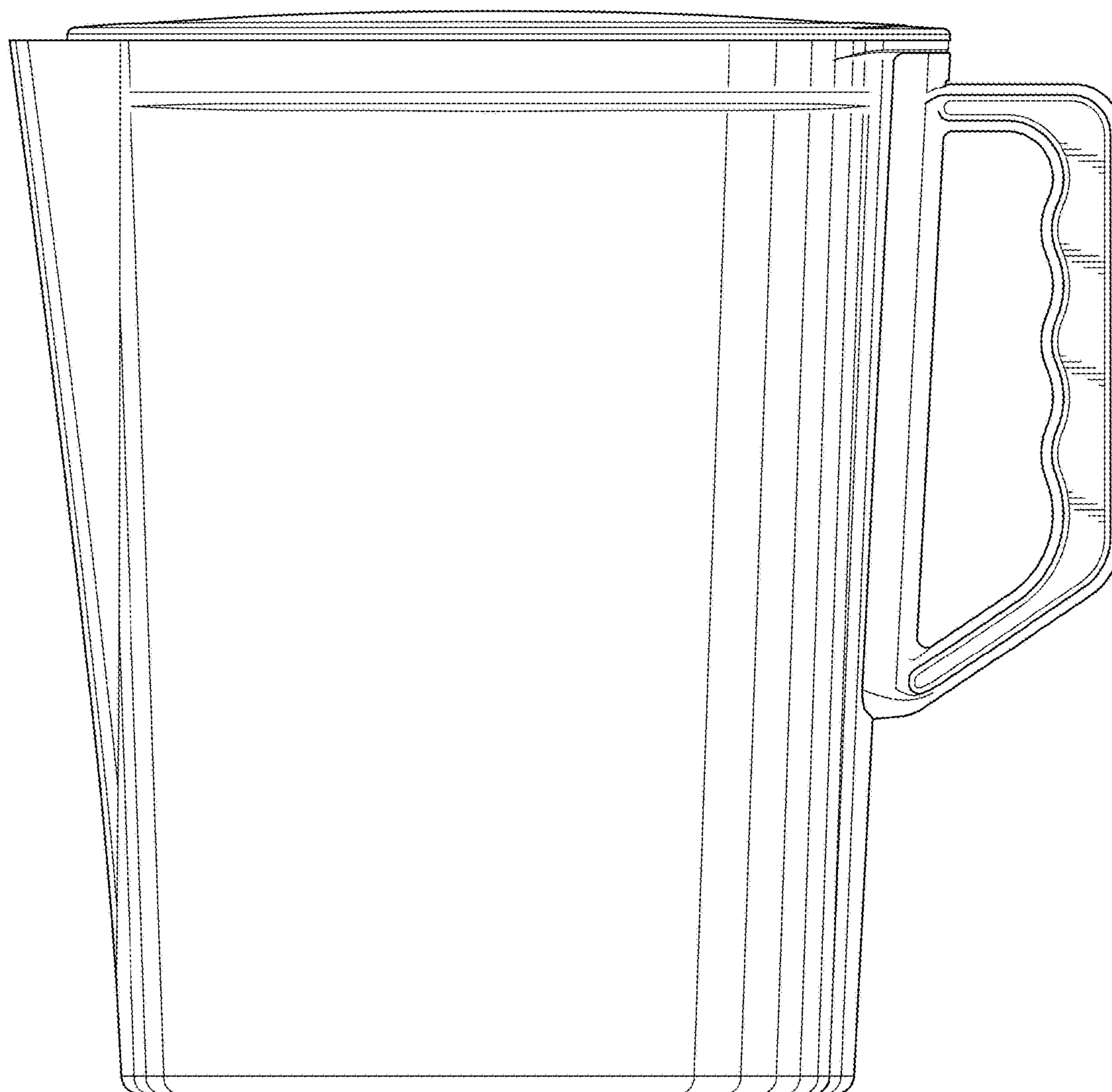

FIG. 4

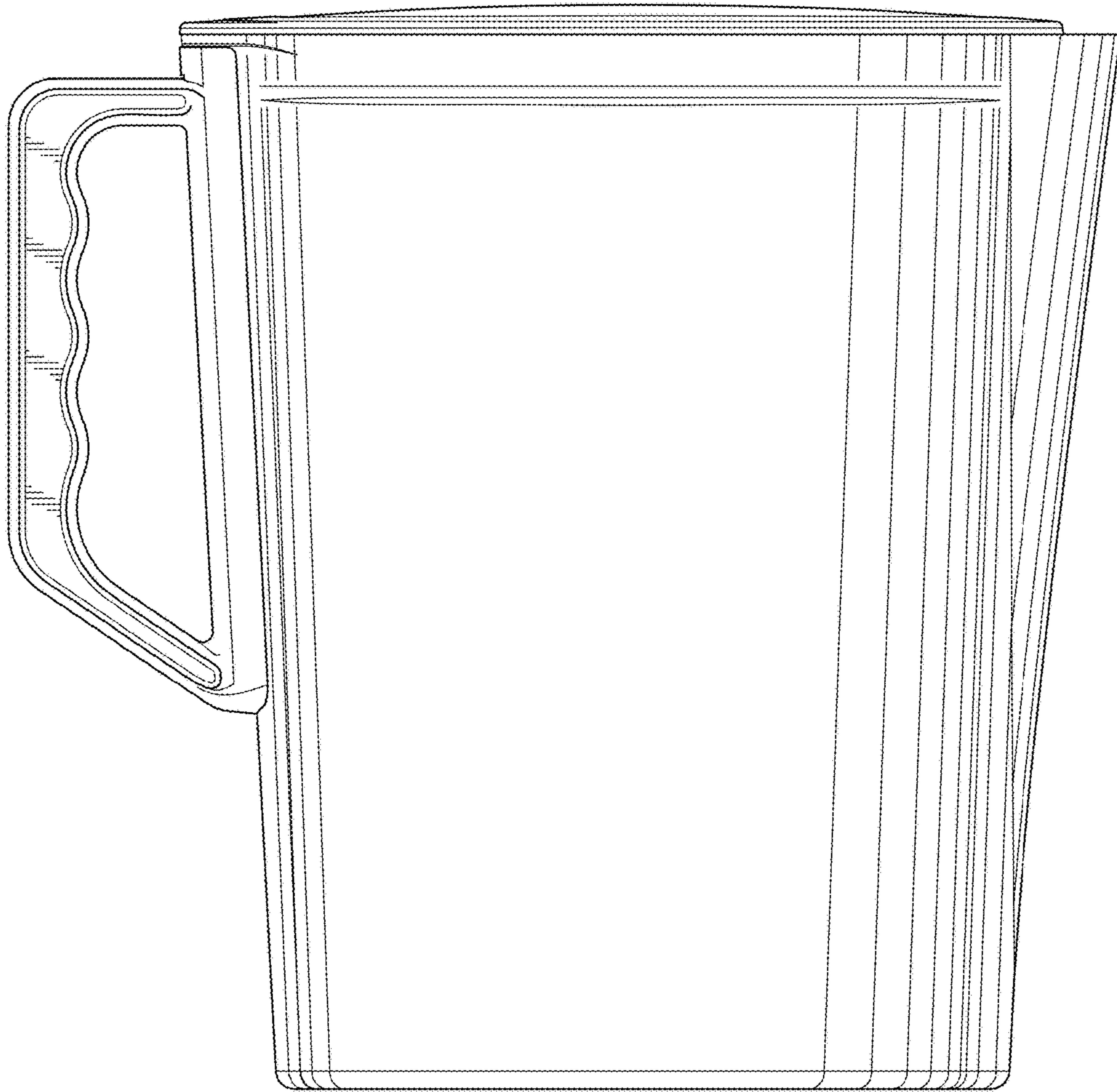

FIG. 5

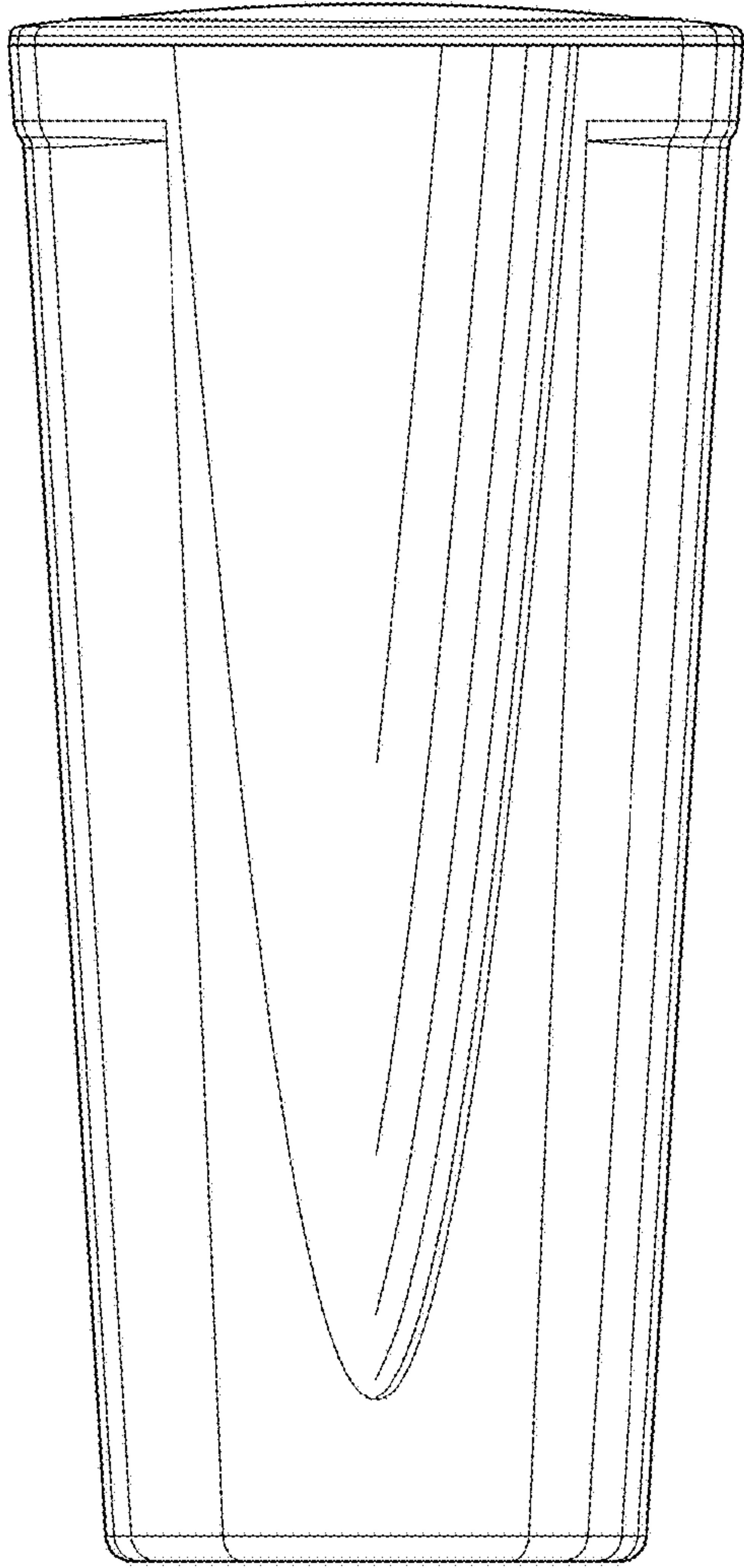

FIG. 6

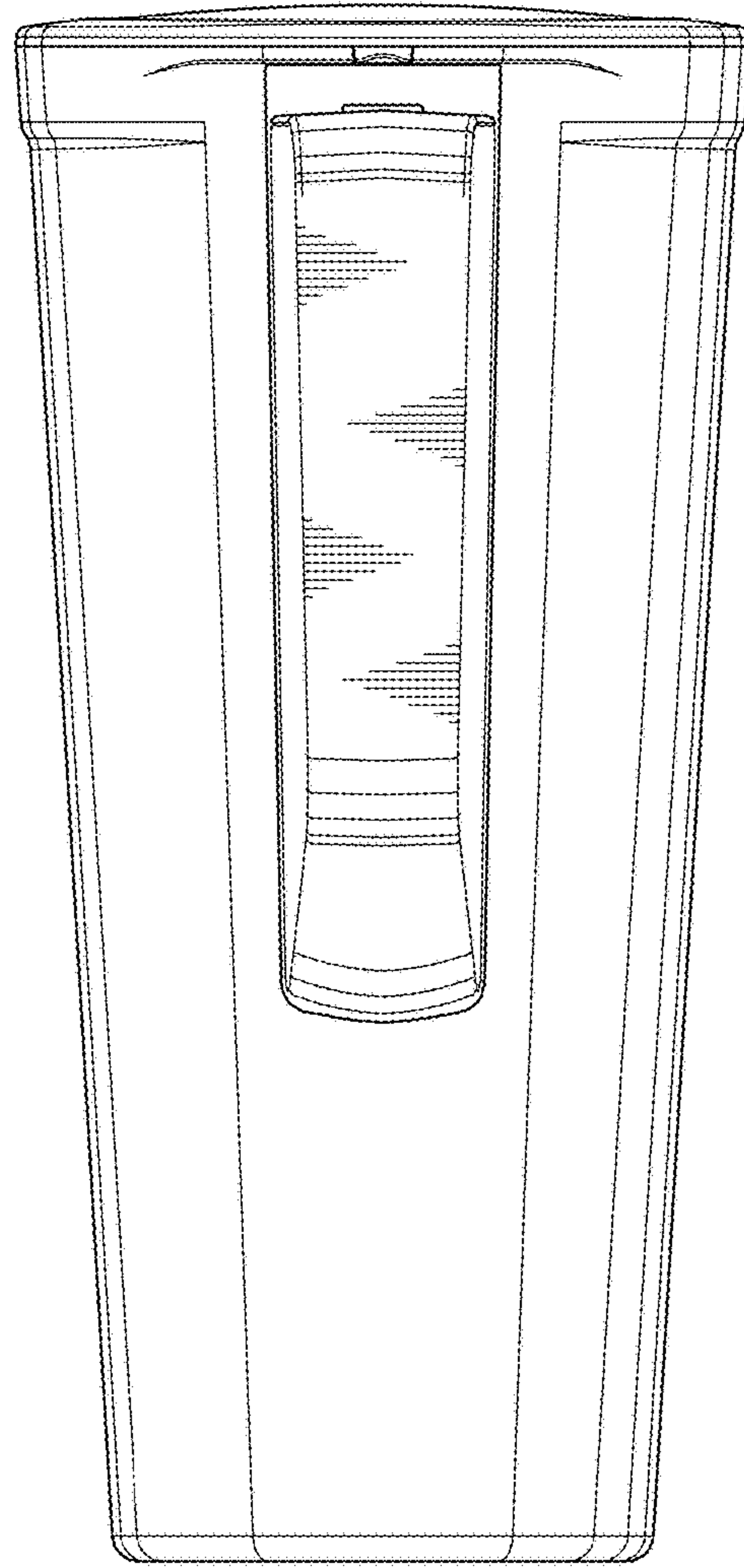

FIG. 7