



US00D789033S

(12) **United States Design Patent**  
**Sumnicht**

(10) **Patent No.:** **US D789,033 S**

(45) **Date of Patent:** **\*\* Jun. 13, 2017**

(54) **SLEEPING BAG**

(71) Applicant: **American Recreation Products, LLC**,  
Boulder, CO (US)

(72) Inventor: **Casey Sumnicht**, Longmont, CO (US)

(73) Assignee: **Exxel Outdoors, LLC**, Boulder, CO  
(US)

(\*\*) Term: **15 Years**

(21) Appl. No.: **29/534,830**

(22) Filed: **Jul. 31, 2015**

(51) **LOC (10) Cl.** ..... **02-01**

(52) **U.S. Cl.**  
USPC ..... **D2/719**

(58) **Field of Classification Search**  
USPC ..... D2/719; D6/589, 595, 596, 598,  
D6/601–603, 617; D21/803–809  
CPC ..... A47G 9/08; A47G 9/083; A47G 9/086  
See application file for complete search history.

(56) **References Cited**

**U.S. PATENT DOCUMENTS**

1,610,799	A	12/1926	Lack et al.	
2,537,537	A	1/1951	Ljungberg	
2,594,438	A	4/1952	Howe	
2,757,390	A	8/1956	Miller	
3,633,227	A	1/1972	Tegeler	
D230,455	S *	2/1974	Hunt	D2/719
3,798,676	A	3/1974	Shanks et al.	
4,158,892	A	6/1979	Gonzales	
4,573,217	A	3/1986	Reed	

(Continued)

**FOREIGN PATENT DOCUMENTS**

CN	2199725	Y	6/1995
CN	201894435	U	7/2011

(Continued)

**OTHER PUBLICATIONS**

Eureka Cimarron +15-Degree—Mummy Sleeping Bag, posted at amazon.com, earliest review date Oct. 8, 2012, [online], acquired on Sep. 12, 2016. Available from Internet, <URL: https://www.amazon.com/Eureka-Cimarron-15-Degree-Mummy-Sleeping/dp/B006MQAQ0A/ref=cm\_cr\_arp\_d\_product\_top?ie=UTF8>.\*

(Continued)

*Primary Examiner* — Cathron Brooks

*Assistant Examiner* — Aula Soroush

(74) *Attorney, Agent, or Firm* — Stinson Leonard Street LLP

(57) **CLAIM**

The ornamental design for a sleeping bag, as shown and described.

**DESCRIPTION**

FIG. 1 is a perspective view of a sleeping bag in a first position of my new design.  
FIG. 2 is a top plan view thereof.  
FIG. 3 is a bottom plan view thereof.  
FIG. 4 is a right side elevation view thereof.  
FIG. 5 a left side elevation view thereof.  
FIG. 6 is a front elevation view thereof.  
FIG. 7 is a rear elevation view thereof.  
FIG. 8 is a perspective view of the sleeping bag in a second position of my new design.  
FIG. 9 is a top plan view thereof.  
FIG. 10 is a bottom plan view thereof.  
FIG. 11 is a right side elevation view thereof.  
FIG. 12 a left side elevation view thereof.  
FIG. 13 is a front elevation view thereof.  
FIG. 14 is a rear elevation view thereof; and,  
FIG. 15 is a perspective view of the sleeping bag in a third position of my new design.

The dotted lines and the dashed lines present in the figures are included for the purpose of illustrating portions of the article that form no part of the claimed design.

**1 Claim, 15 Drawing Sheets**

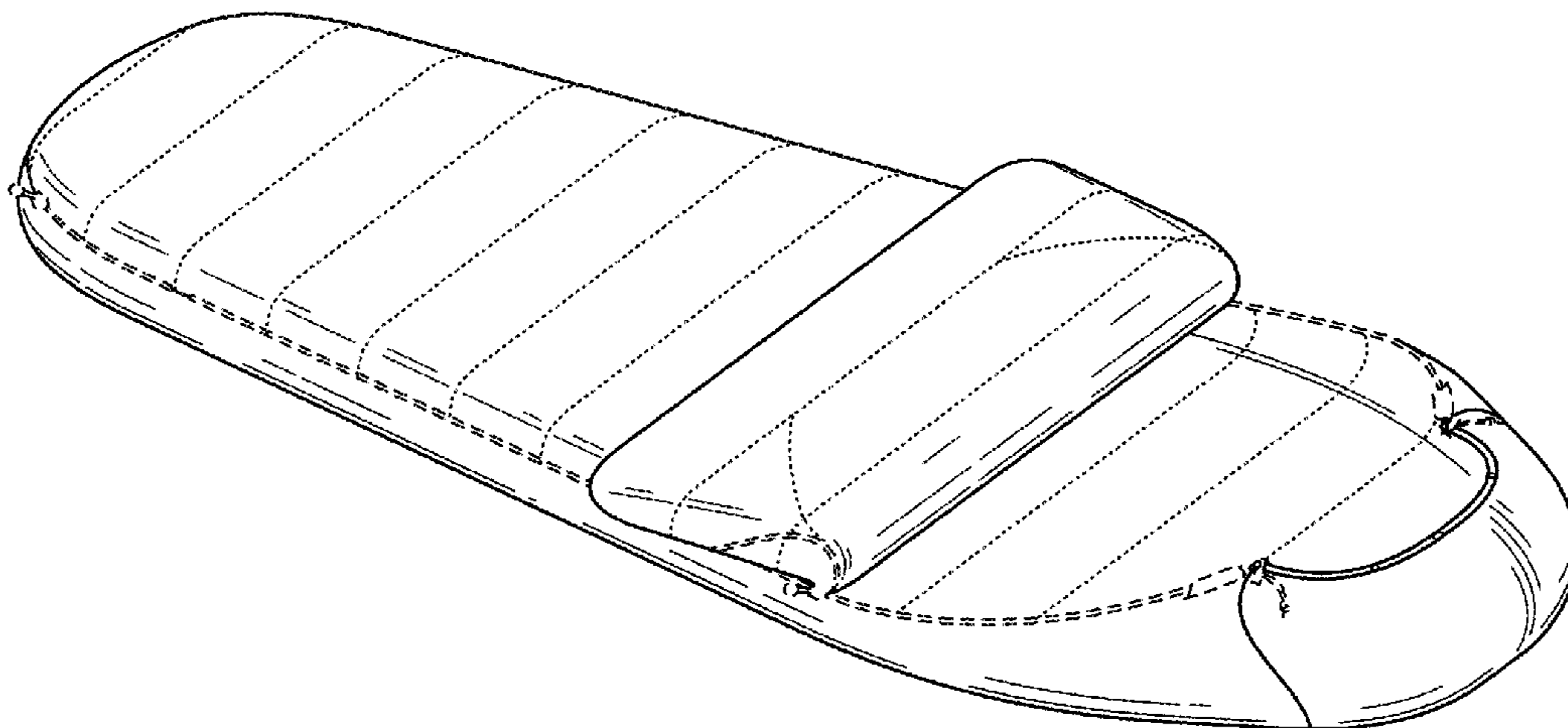

(56)

References Cited

U.S. PATENT DOCUMENTS

4,752,971 A 6/1988 Meserol  
 4,787,105 A 11/1988 Phillips et al.  
 4,862,533 A 9/1989 Adams, III  
 4,884,303 A \* 12/1989 Scherer ..... A47G 9/086  
 2/69.5  
 4,888,828 A 12/1989 Tatsuno  
 4,894,878 A 1/1990 Roach  
 4,977,632 A 12/1990 Ong  
 4,989,282 A 2/1991 Goldstein  
 4,996,733 A 3/1991 Tsai  
 5,044,031 A 9/1991 Sherwood et al.  
 5,257,427 A 11/1993 Hinshaw  
 5,414,881 A 5/1995 Terrazas  
 5,473,779 A \* 12/1995 Kramer ..... A47G 9/086  
 5/413 R  
 5,490,294 A 2/1996 Kramer  
 5,657,497 A 8/1997 Howe  
 D405,585 S 2/1999 Stevens  
 5,875,492 A 3/1999 Moss  
 5,960,492 A 10/1999 Byrne  
 5,966,756 A 10/1999 Cartier  
 5,966,759 A 10/1999 Sanders  
 5,996,146 A 12/1999 McPherson  
 6,006,360 A 12/1999 Reed  
 6,018,830 A \* 2/2000 Howe ..... A47G 9/086  
 2/69.5  
 6,401,248 B1 6/2002 Christensen  
 6,408,462 B1 6/2002 Moore  
 6,438,774 B1 8/2002 Michaelis et al.  
 6,449,787 B1 9/2002 Thorne  
 6,708,343 B1 3/2004 Ceron  
 6,851,127 B1 2/2005 Khan  
 7,178,185 B1 2/2007 Nattler  
 D569,159 S \* 5/2008 Walker ..... D6/595  
 D586,537 S \* 2/2009 Walker ..... D2/719  
 7,587,769 B1 9/2009 McDermott  
 D601,327 S 10/2009 Anderson et al.  
 7,752,690 B1 7/2010 Seth  
 D626,309 S \* 11/2010 Abrams ..... D2/719  
 D629,176 S \* 12/2010 Abrams ..... D2/719  
 D650,152 S \* 12/2011 Abrams ..... D2/719  
 D654,248 S 2/2012 Abrams et al.  
 D675,810 S 2/2013 Bridges  
 8,539,620 B1 9/2013 Wynh  
 8,695,133 B2 4/2014 Christensen et al.  
 8,707,481 B1 4/2014 Juarez  
 8,898,833 B2 12/2014 Coates  
 D742,618 S 11/2015 Sumnicht et al.  
 2001/0044964 A1 11/2001 Phillips  
 2003/0159192 A1 8/2003 La Scala  
 2004/0199998 A1 10/2004 Shinner  
 2005/0034234 A1 2/2005 Bellick et al.  
 2005/0034235 A1 \* 2/2005 Bellick ..... A47G 9/086  
 5/413 R  
 2005/0039241 A1 2/2005 Khan  
 2005/0283910 A1 12/2005 DuQue  
 2006/0200906 A1 9/2006 Deering et al.  
 2007/0136946 A1 6/2007 Haislip  
 2008/0028518 A1 2/2008 Miotke et al.  
 2008/0066229 A1 3/2008 Auer et al.  
 2008/0078027 A1 4/2008 Smith  
 2008/0222803 A1 9/2008 Korshamn  
 2008/0235848 A1 10/2008 Wilder et al.

2010/0122395 A1 5/2010 Wall et al.  
 2010/0146680 A1 6/2010 Cuoco  
 2010/0170039 A1 7/2010 Davis  
 2010/0186166 A1 7/2010 Sulentic  
 2010/0205714 A1 8/2010 Pollack  
 2010/0256716 A1 \* 10/2010 Haislip ..... A41D 15/04  
 607/108  
 2010/0299832 A1 \* 12/2010 Alford ..... A47G 9/086  
 5/413 AM  
 2011/0023233 A1 2/2011 Hilgeman, Jr.  
 2011/0173749 A1 7/2011 Martray  
 2011/0258749 A1 10/2011 Hibbs  
 2012/0005801 A1 1/2012 Parr  
 2012/0110716 A1 5/2012 Christensen et al.  
 2012/0276802 A1 11/2012 Anderman et al.  
 2012/0284922 A1 11/2012 Gangan et al.  
 2012/0297539 A1 11/2012 Like et al.  
 2012/0311763 A1 12/2012 King  
 2013/0171906 A1 7/2013 Smoot et al.  
 2013/0239325 A1 9/2013 Kelkel et al.  
 2014/0020177 A1 1/2014 Coates  
 2014/0033395 A1 2/2014 Torgersen  
 2014/0150159 A1 6/2014 Alluna  
 2014/0165257 A1 6/2014 Wynh  
 2014/0298584 A1 10/2014 Sumnicht et al.  
 2014/0345051 A1 \* 11/2014 Benninger ..... A47G 9/086  
 5/413 R  
 2014/0352063 A1 12/2014 Mitchell et al.  
 2014/0352167 A1 12/2014 Peters  
 2015/0020309 A1 1/2015 Pitchforth et al.

FOREIGN PATENT DOCUMENTS

CN 201938912 U 8/2011  
 CN 202457520 U 10/2012  
 CN 203493268 U 3/2014  
 EP 0761145 A2 2/1998  
 EP 1472959 A1 11/2004  
 EP 1600085 A1 11/2005  
 GB 191411589 A 2/1915  
 JP 2006320690 A 11/2006  
 JP 2011219881 A 11/2011

OTHER PUBLICATIONS

Suisse Sport Everest Sleeping Bag, posted at amazon.com, earliest review date May 1, 2010, [online], acquired on Sep. 12, 2016. Available from Internet, <URL:https://www.amazon.com/Suisse-Sport-Everest-Sleeping-Bag/dp/B002EIU14Q/ref=cm\_cr\_arpd\_product\_top?ie=UTF8>.\*  
 Ozark Trail 40F Climatech Mummy Sleeping Bag, posted at trails2brews.com, earliest date available Mar. 6, 2015, [online], acquired on Sep. 12, 2016. Available from Internet, <URL: https://trails2brews.com/2015/03/06/frugal-friday-sleeping-bag/>.\*  
 Suisse Sport Alpine Sleeping Bag, posted at everythingsummercamp.com, earliest date available Oct. 7, 2013, [online], acquired on Sep. 12, 2016. Available from Internet, <URL: http://www.everythingsummercamp.com/suisse-sport-alpine-sleeping-bag>.\*  
 REI Expedition—20F Bag, posted at summitpost.org, earliest date available Sep. 22, 2015, [online], acquired on Sep. 12, 2016. Available from Internet, <URL: http://www.summitpost.org/outdoor-gear/rei-expedition-20f-bag/7401>.\*

\* cited by examiner

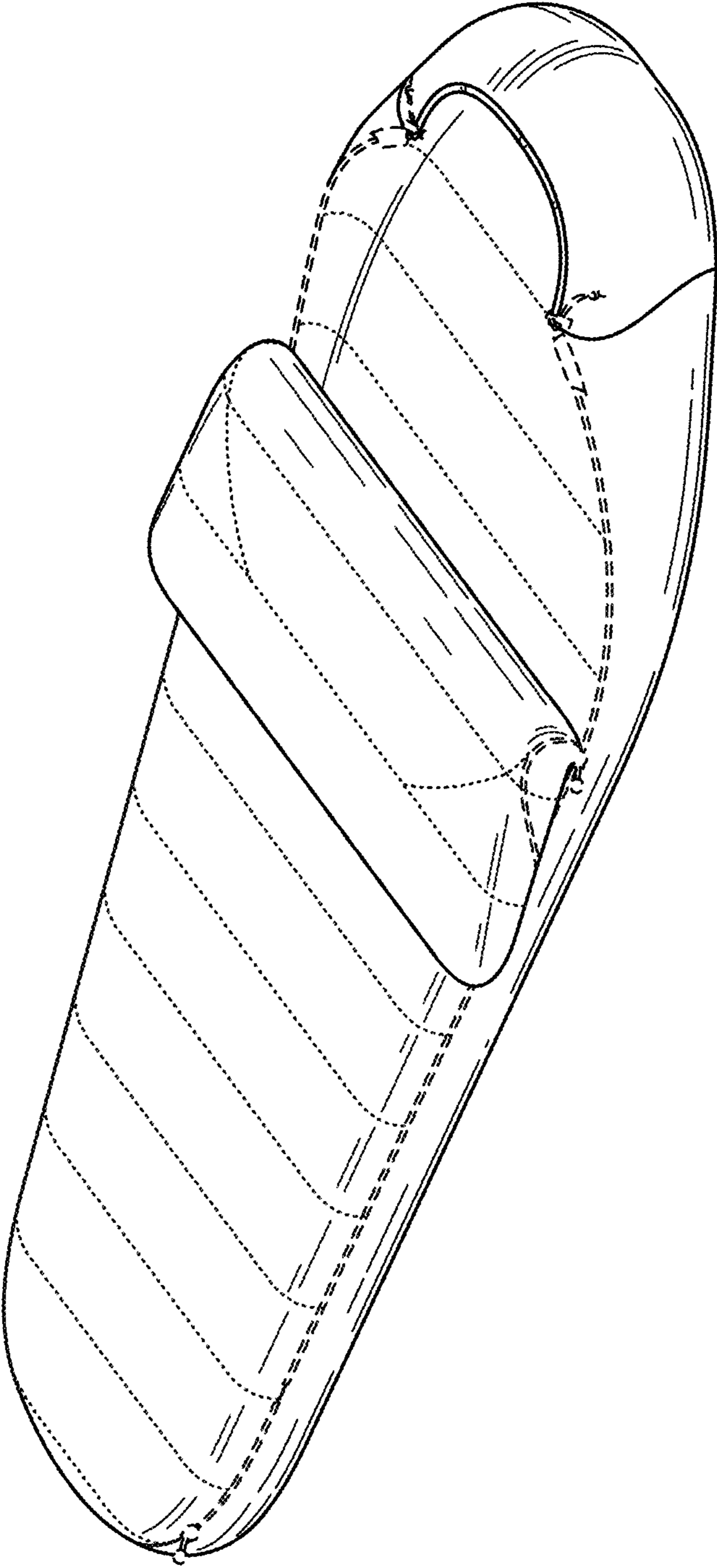

FIG. 1

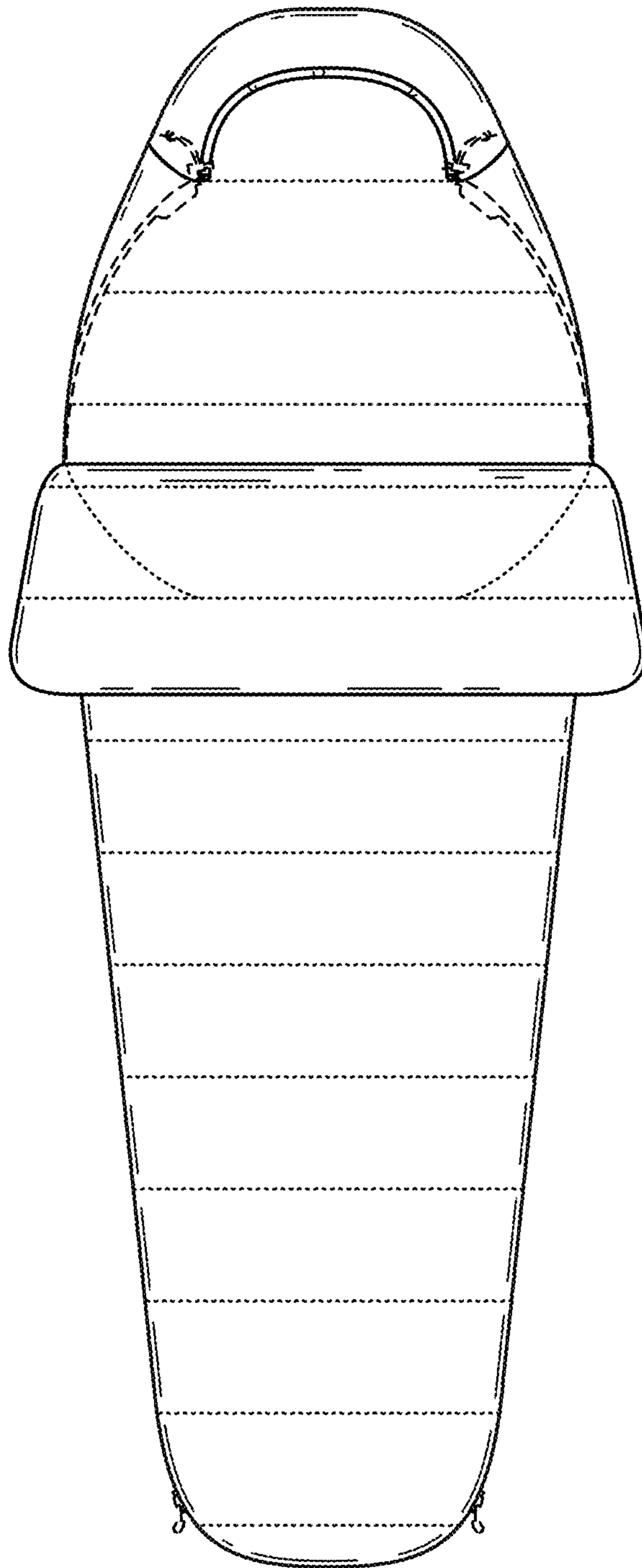

FIG. 2

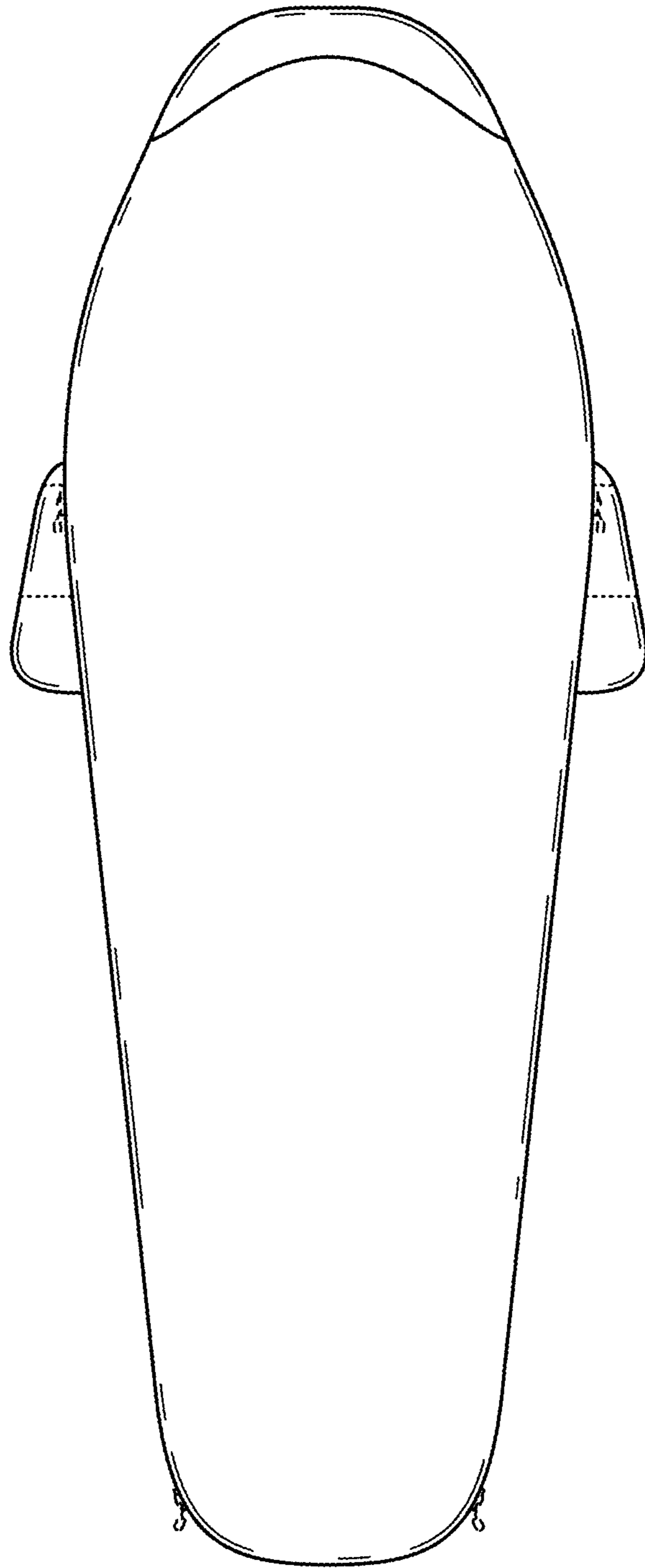

FIG. 3

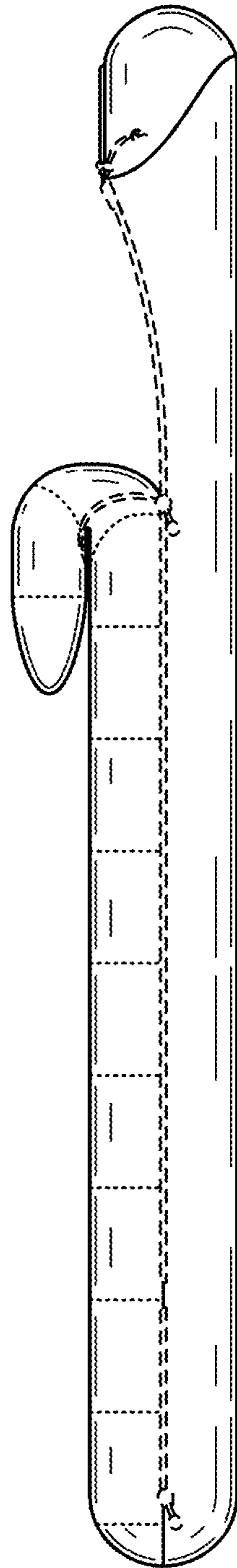

FIG. 4

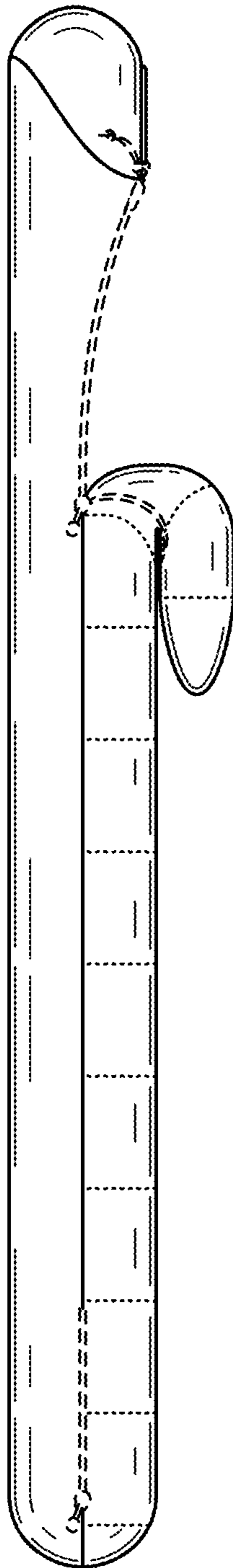

FIG. 5

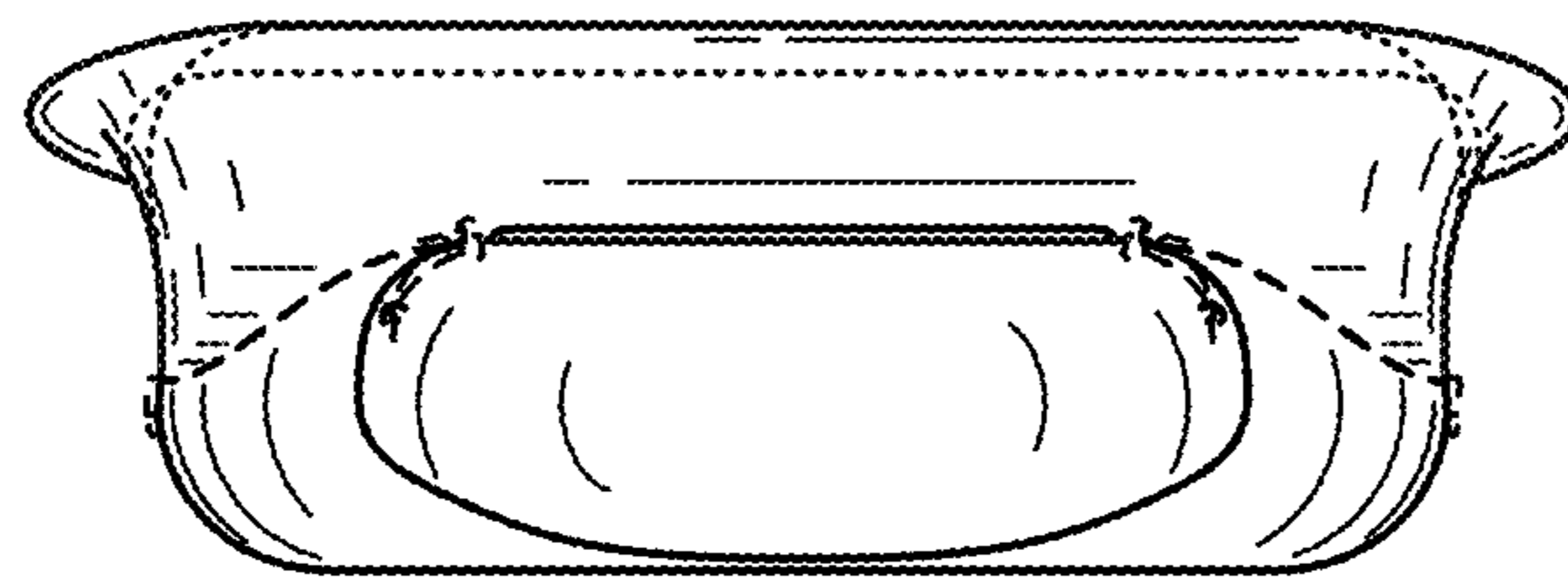

FIG. 6



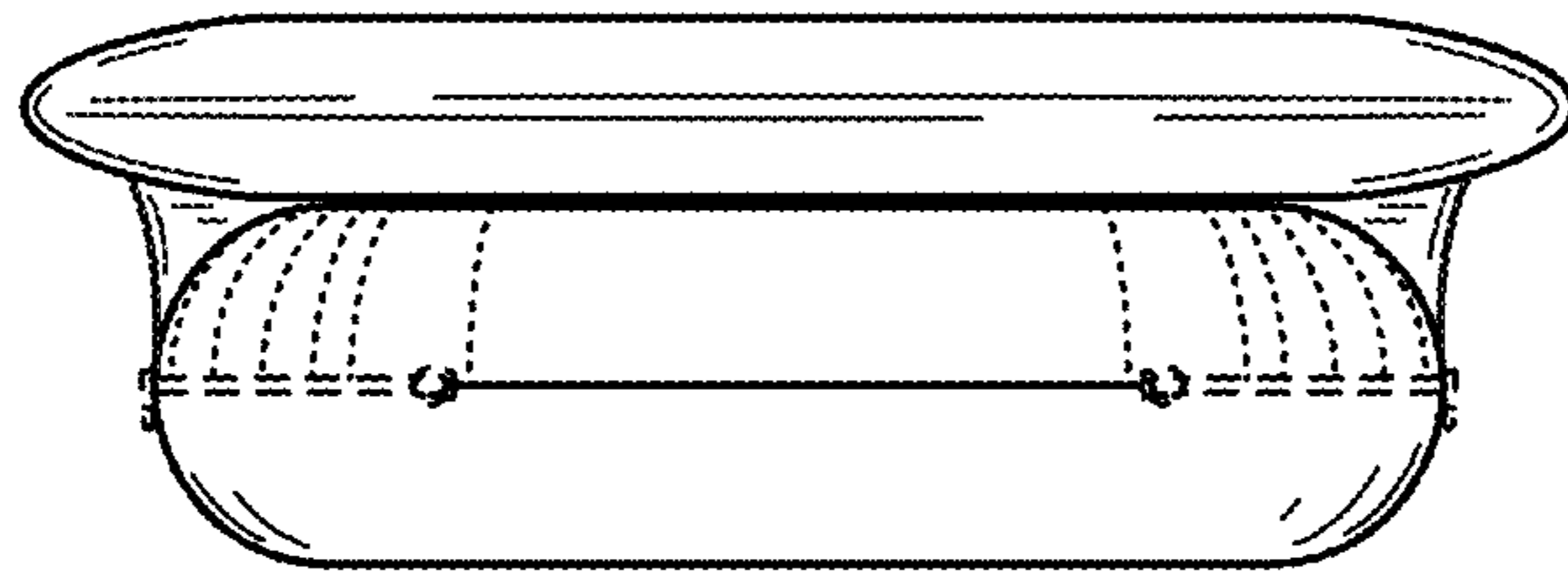

FIG. 7

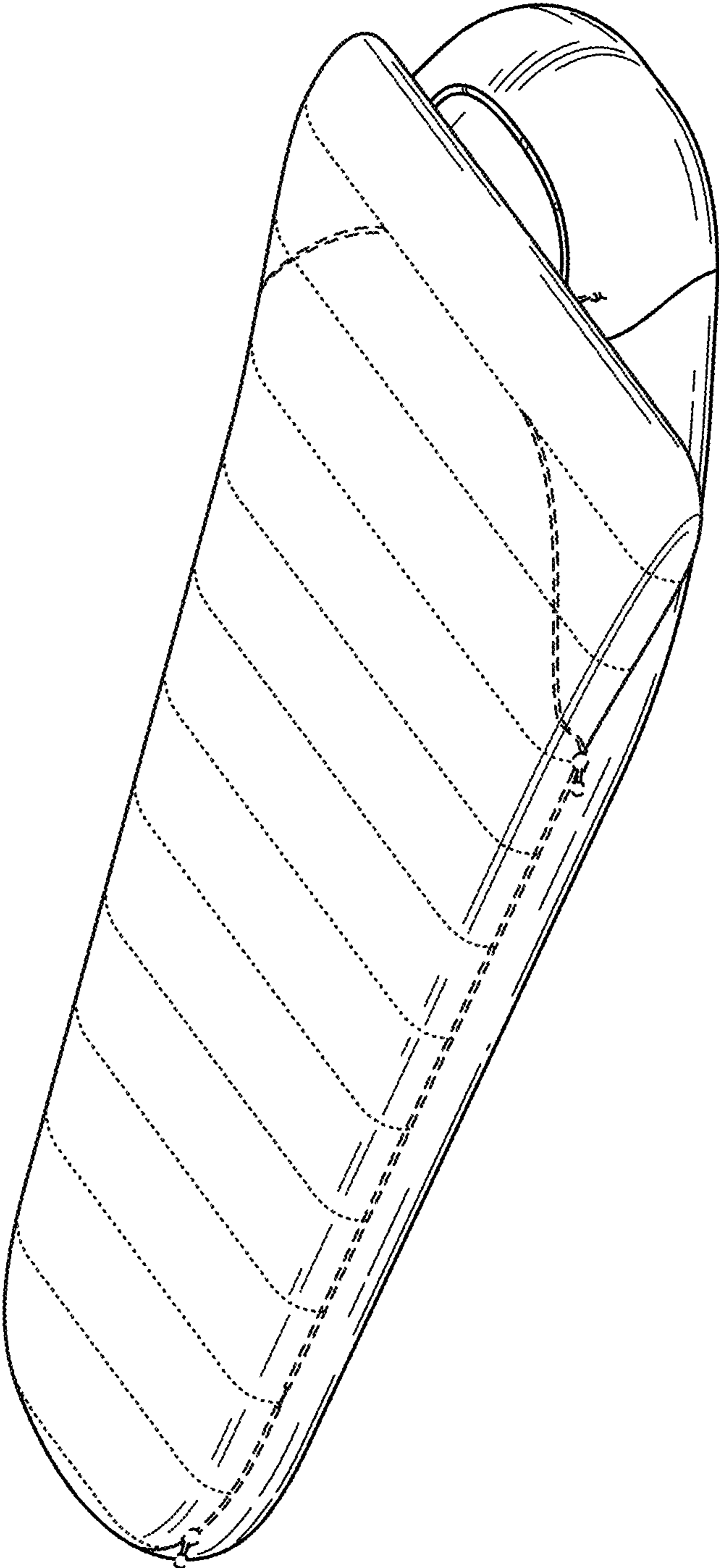

FIG. 8

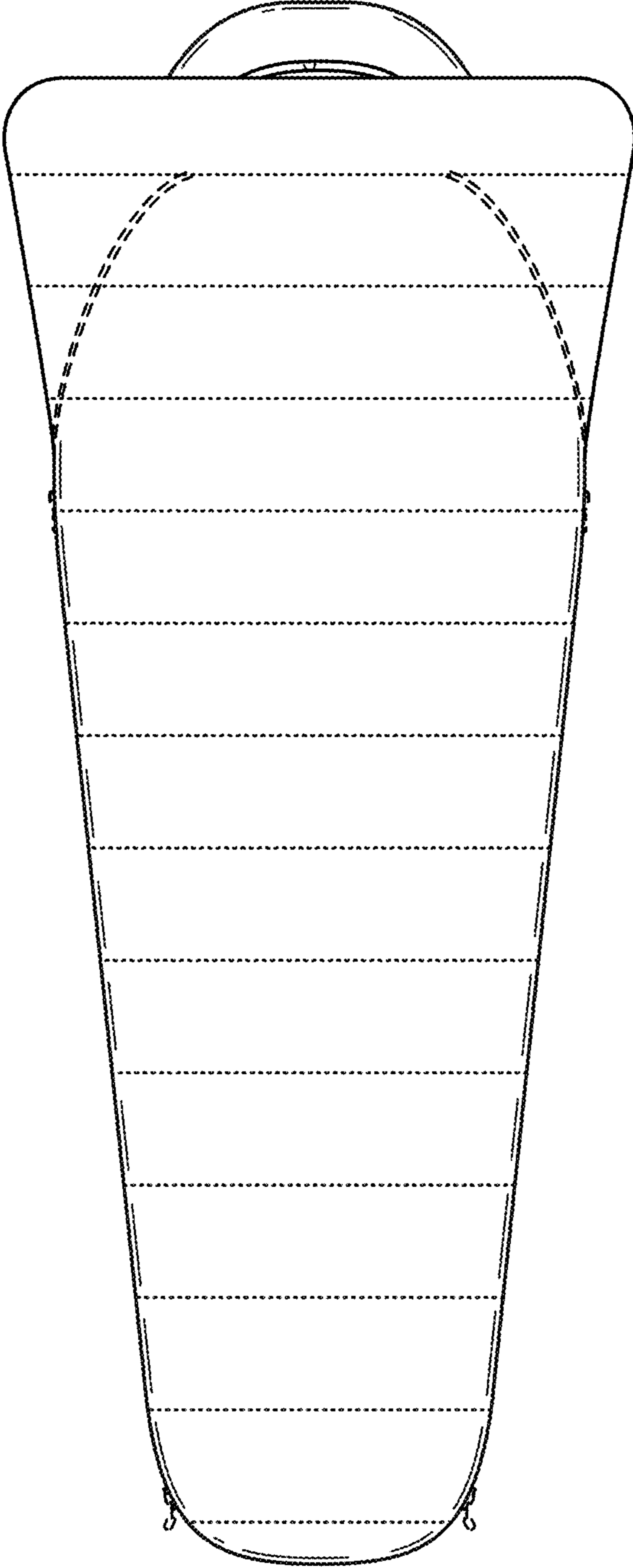

FIG. 9

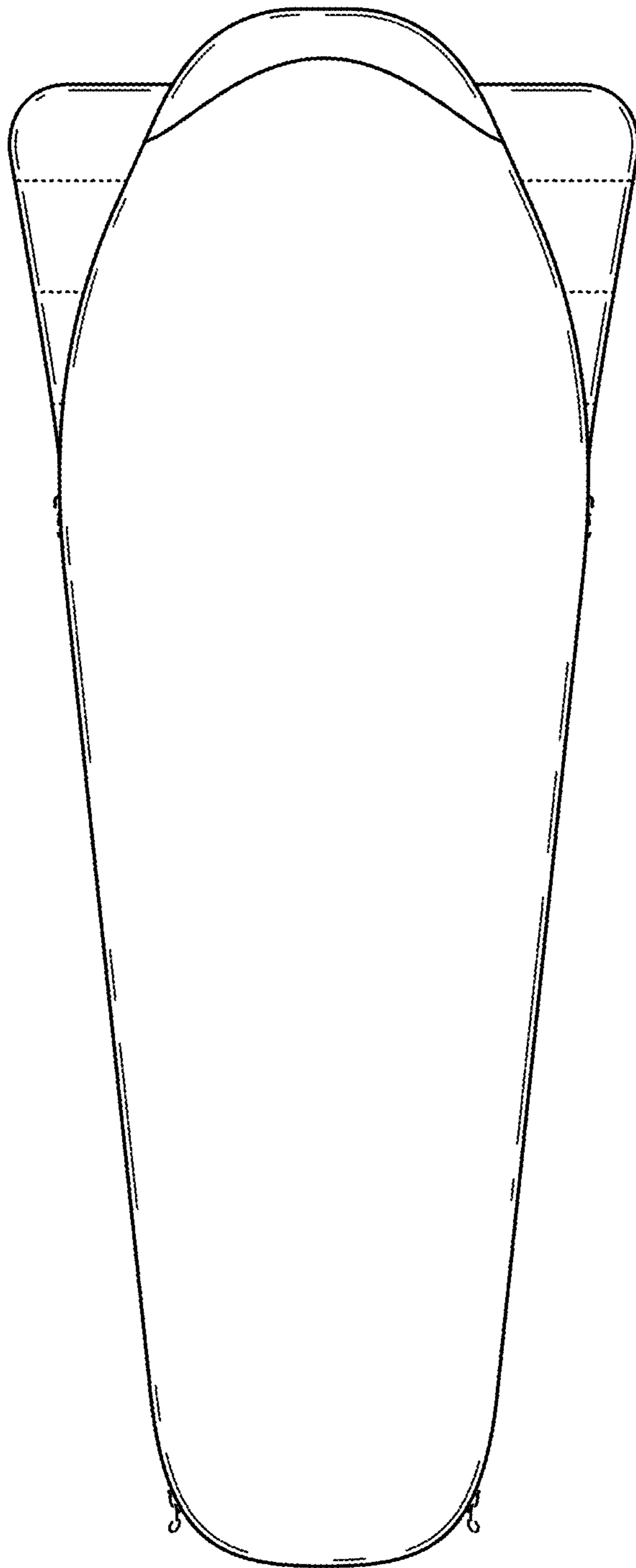

FIG. 10

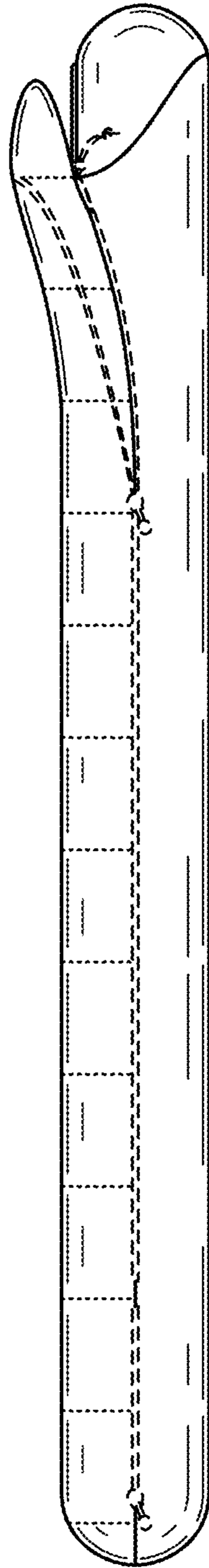

FIG. 11

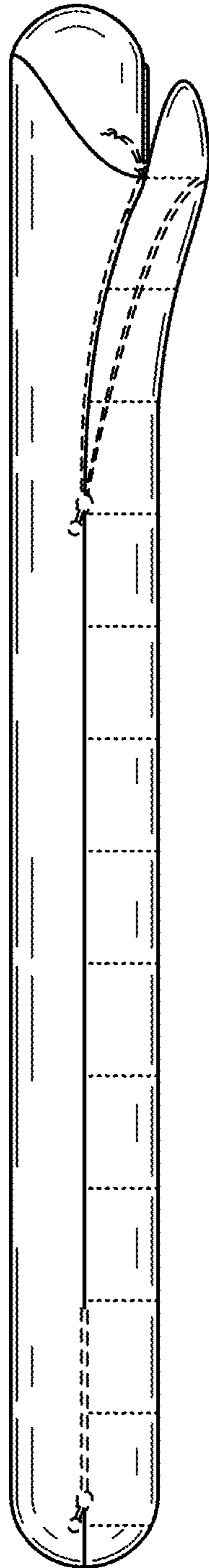

FIG. 12

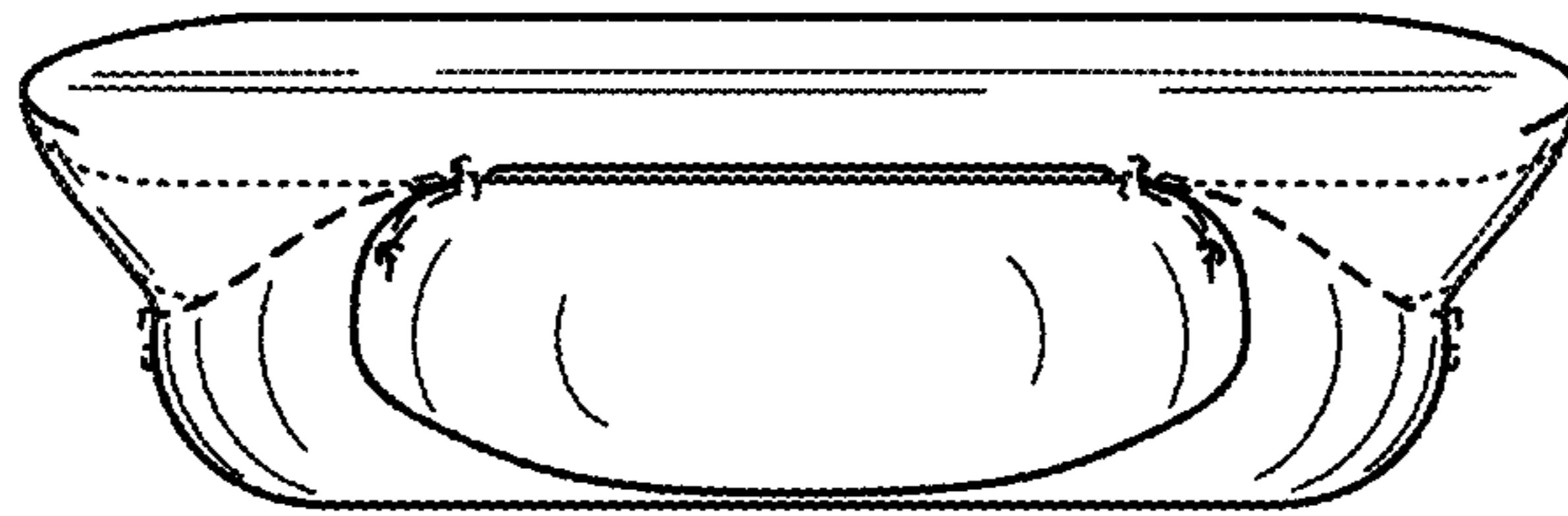

FIG. 13

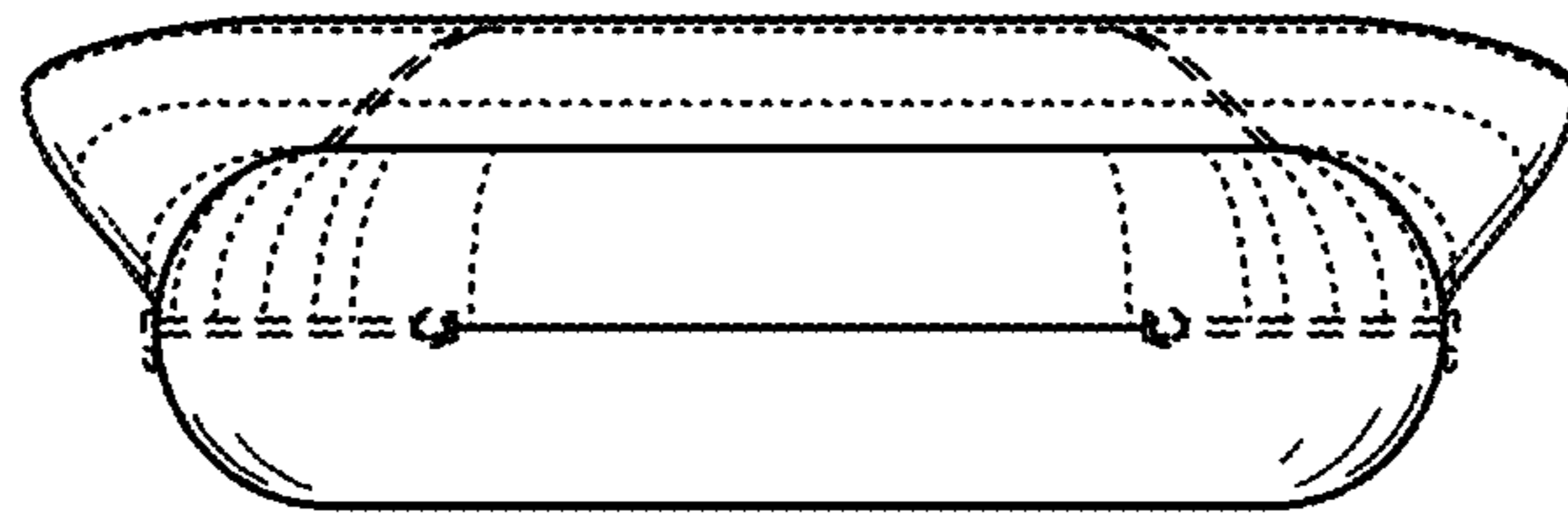

FIG. 14



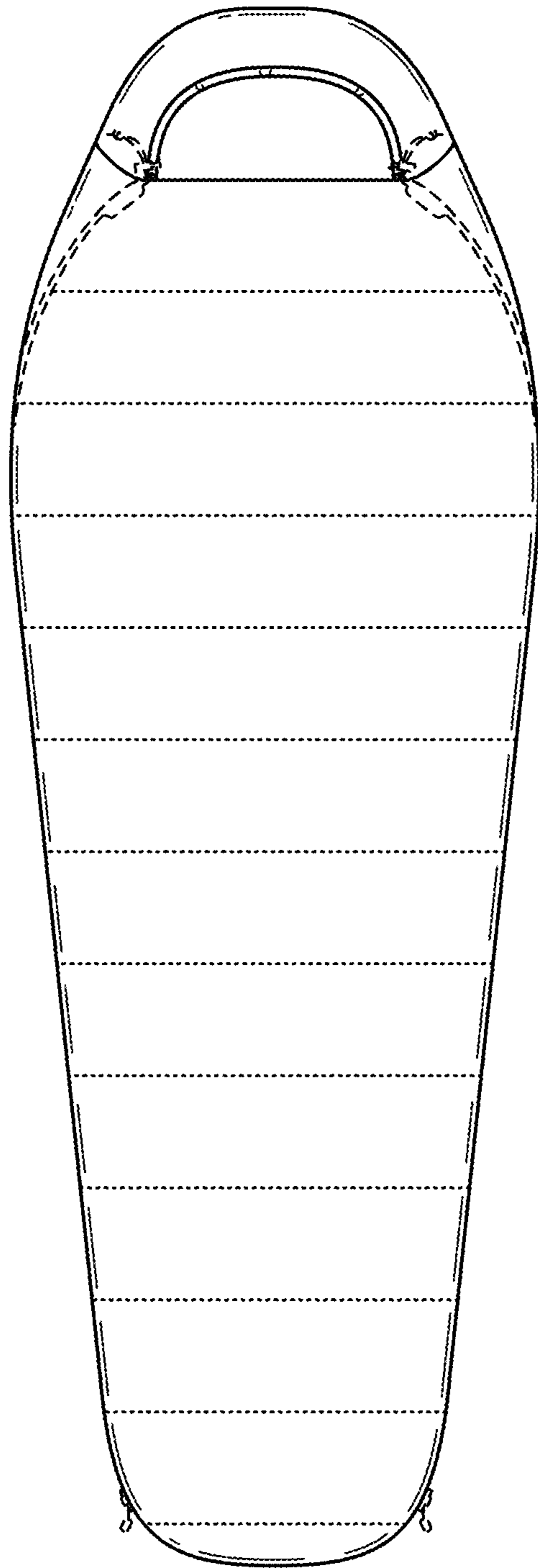

FIG. 15