



US00D788906S

(12) **United States Design Patent** (10) **Patent No.:** **US D788,906 S**
Dittrich et al. (45) **Date of Patent:** **** Jun. 6, 2017**

(54) EAR PLUG FOR SWIMMERS	4,094,315 A * 6/1978 Leight A61F 11/08 128/864
(71) Applicant: EAR LABS AB, Malmö (SE)	D253,723 S * 12/1979 Leight 128/864 D265,129 S * 6/1982 Leight D24/106
(72) Inventors: Christian Dittrich, Löderup (SE); Claes Lundin, Malmö (SE); Casper Asmussen, Malmö (SE)	D408,526 S * 4/1999 Westerdal D24/106 D435,645 S * 12/2000 Westerdal D24/106 D437,048 S * 1/2001 Hirshfeld D24/106 D492,991 S * 7/2004 Chiang D24/106 D511,381 S * 11/2005 Chiang D24/106 D521,637 S * 5/2006 Yang D24/106 D539,415 S * 3/2007 Fleming D24/106 D567,230 S * 4/2008 Seto D14/223 D578,638 S * 10/2008 Falco D24/106 D591,416 S * 4/2009 Prowizor D24/106 D591,732 S * 5/2009 Burton D14/205 D604,409 S * 11/2009 Scanlon D24/106 D760,887 S * 7/2016 Dittrich D24/106
(73) Assignee: EAR LABS AB, Malmö (SE)	2010/0294285 A1 * 11/2010 Turdjian A61F 11/08 128/867
(**) Term: 15 Years	
(21) Appl. No.: 35/500,280	
(22) Filed: Nov. 4, 2015	

(80) **Hague Agreement Data**

Int. Filing Date: **Nov. 4, 2015**
Int. Reg. No.: **DM/088143**
Int. Reg. Date: **Nov. 4, 2015**
Int. Reg. Pub. Date: **Nov. 20, 2015**

* cited by examiner

Primary Examiner — Darlington Ly
(74) *Attorney, Agent, or Firm* — Larson & Larson, P.A.;
Frank Liebenow

(30) **Foreign Application Priority Data**

May 13, 1920 (EM) 002699793-0001

(51) **LOC (10) Cl.** **24-04**

(52) **U.S. Cl.**
USPC **D24/106**

(58) **Field of Classification Search**
USPC D14/205, 206, 226; D24/106, 173, 174;
D29/112; 128/864, 867
CPC A61F 11/08; A61F 2011/085
See application file for complete search history.

(56) **References Cited**

U.S. PATENT DOCUMENTS

3,800,791 A * 4/1974 Visor A61F 11/10
128/864
D242,743 S * 12/1976 Leight 128/864

(57) **CLAIM**

The ornamental design for an ear plug for swimmers, as shown and described.

DESCRIPTION

1.1 is a front elevation view of an ear plug for swimmers showing our new design;
1.2 is a left side elevation view thereof;
1.3 is a right side elevation view thereof;
1.4 is a top plan view thereof;
1.5 is a bottom plan view thereof;
1.6 is a rear elevation view thereof; and
1.7 is a rear perspective view thereof.
The broken lines in the drawings illustrate portions of the ear plug for swimmers that form no part of the claimed design.

1 Claim, 7 Drawing Sheets

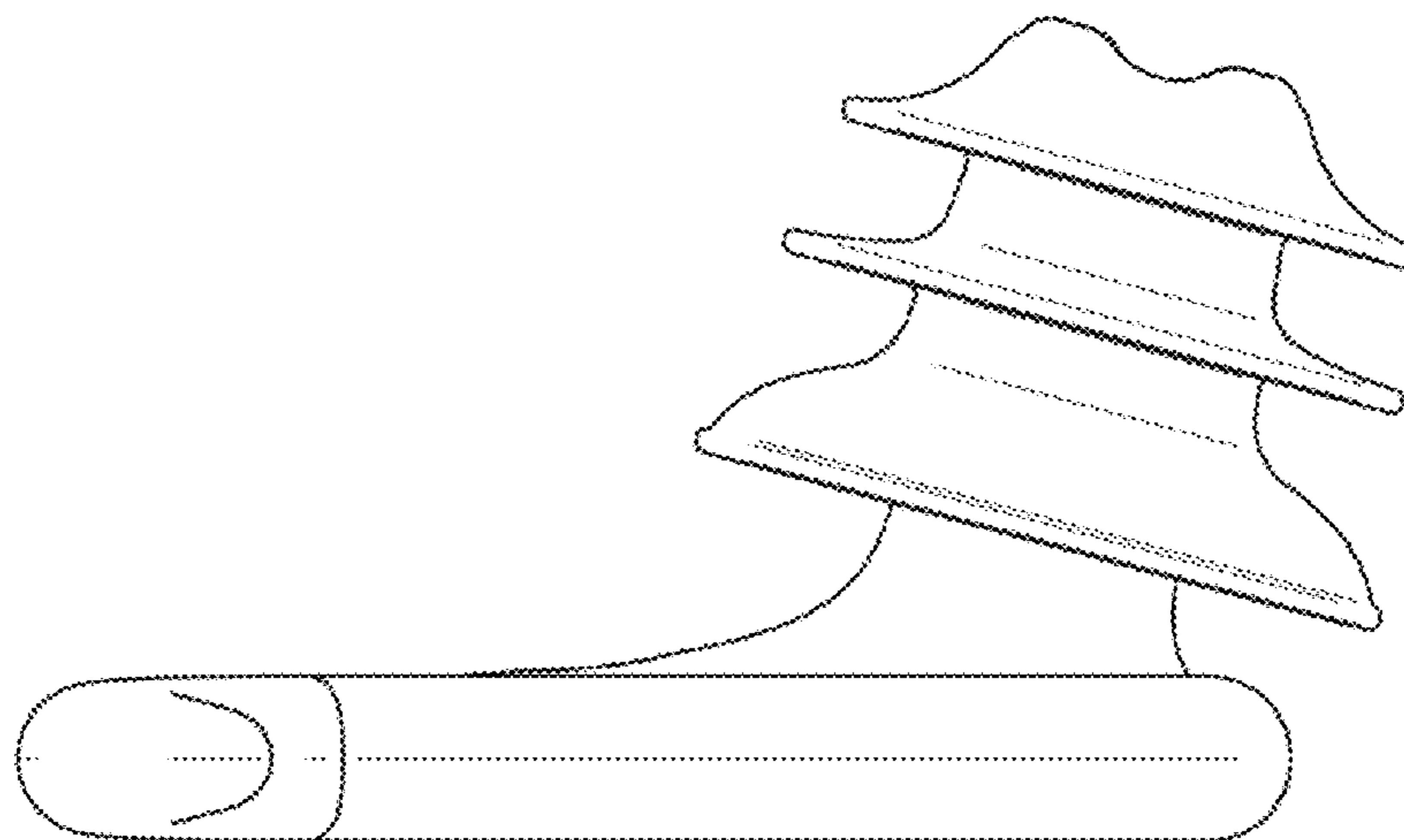

1.1

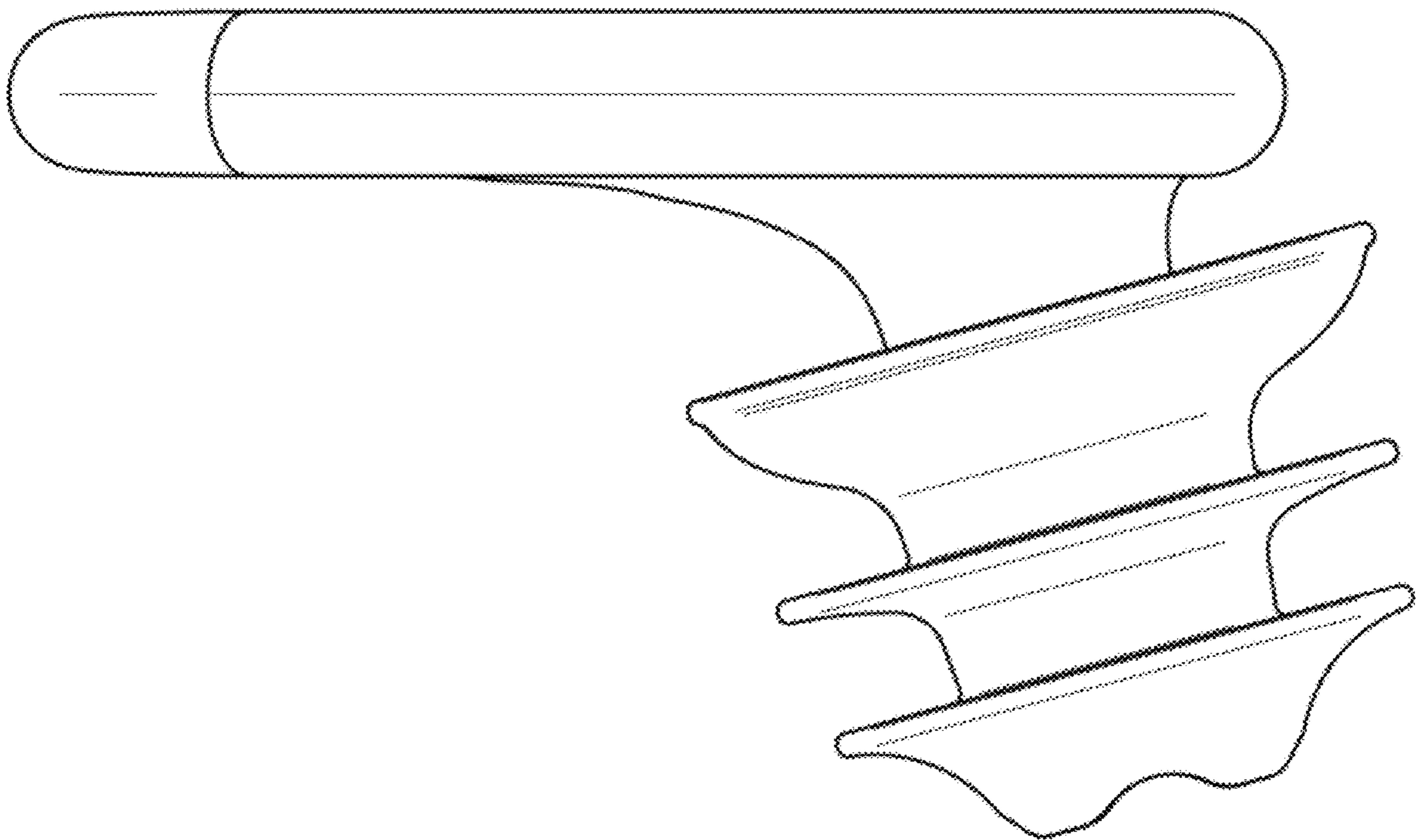

1.2

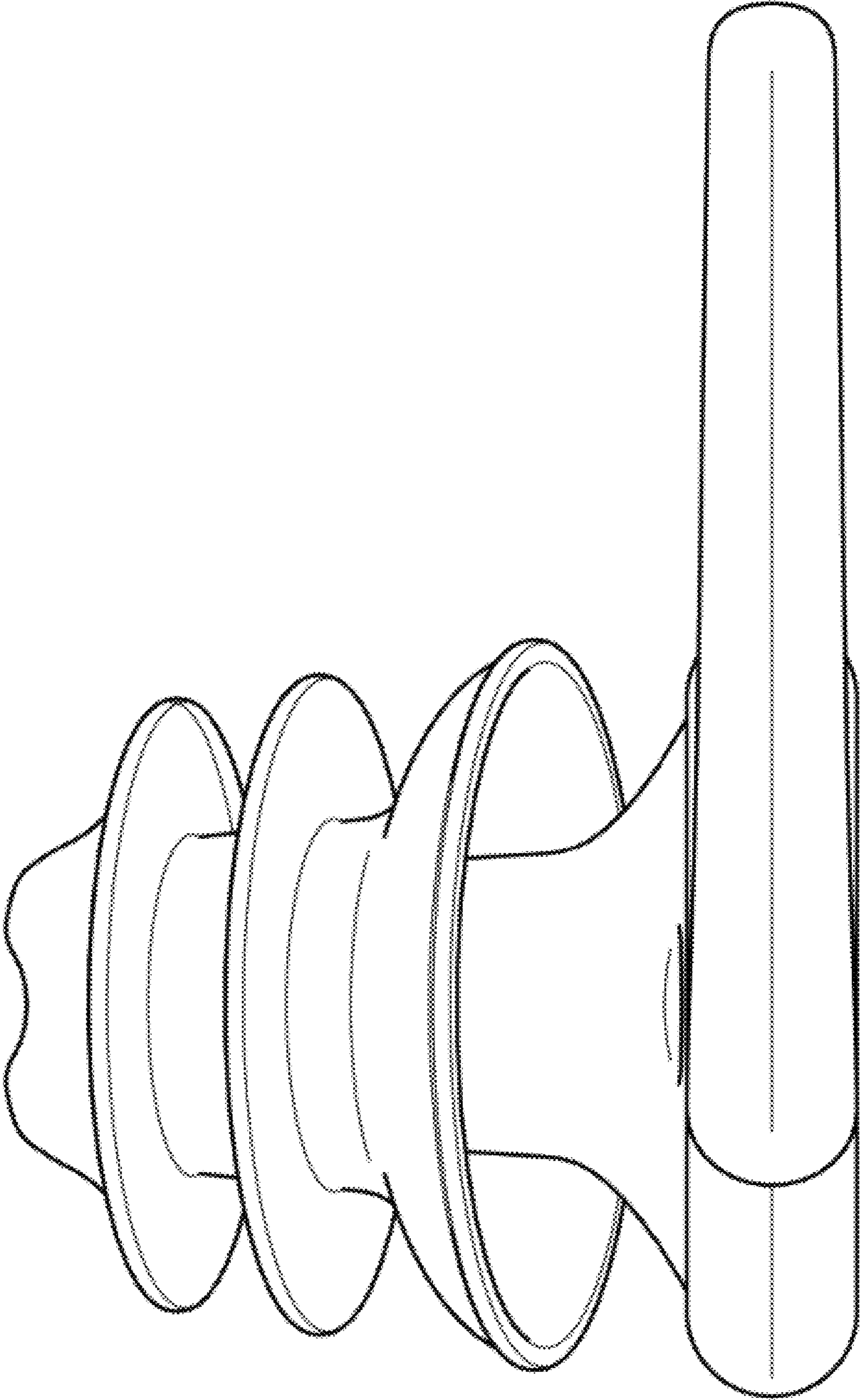

1.3

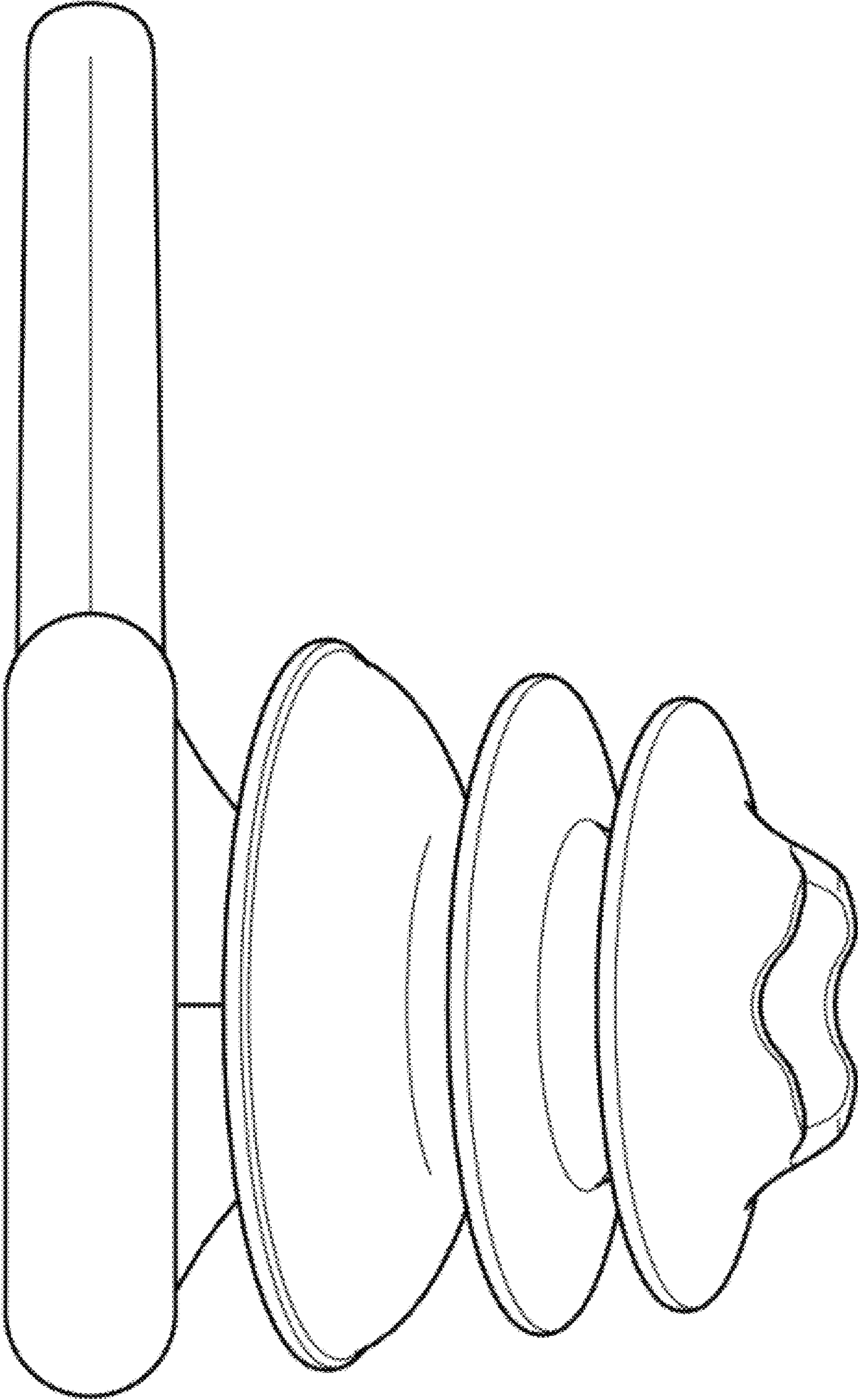

1.4

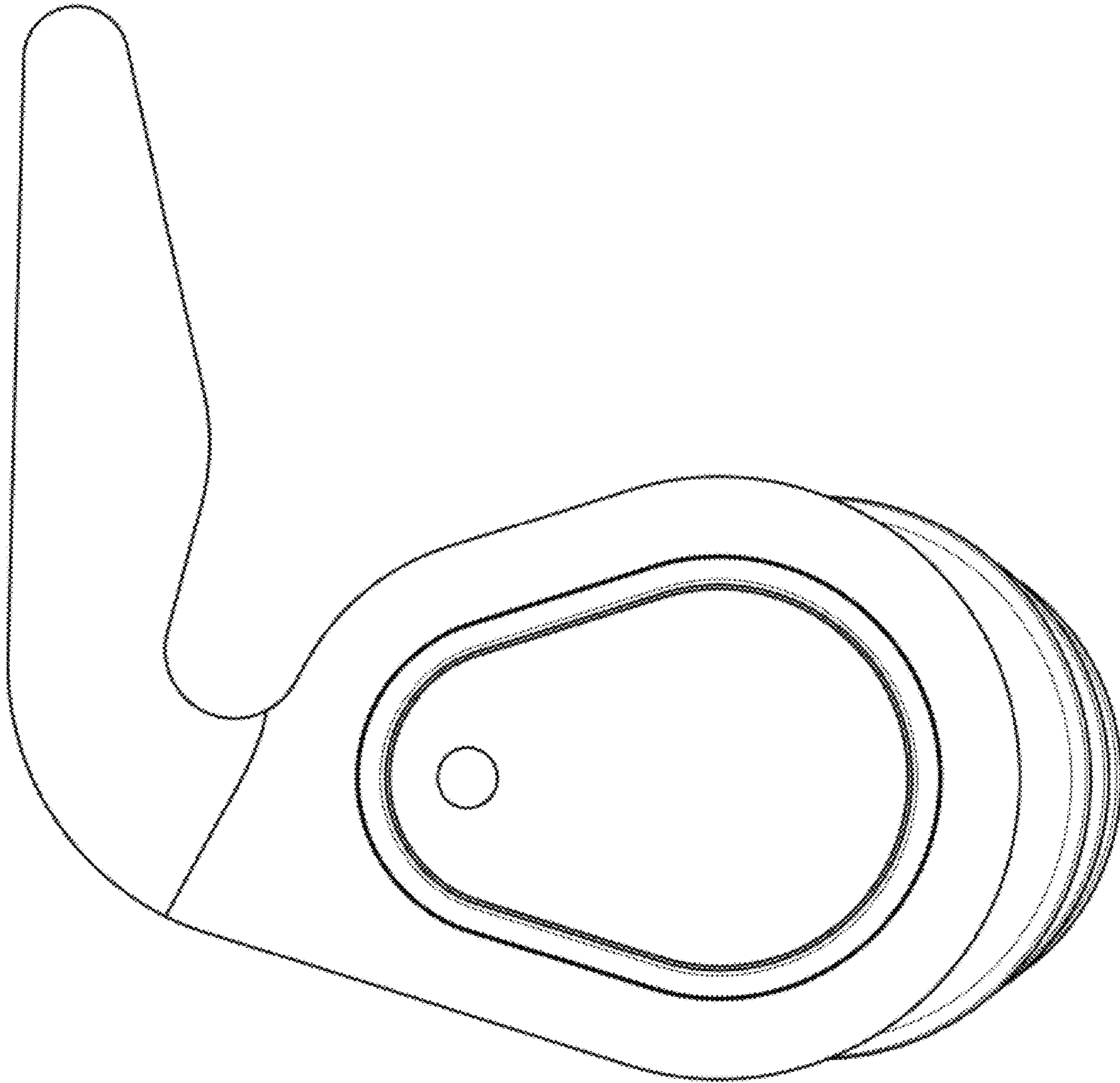

1.5

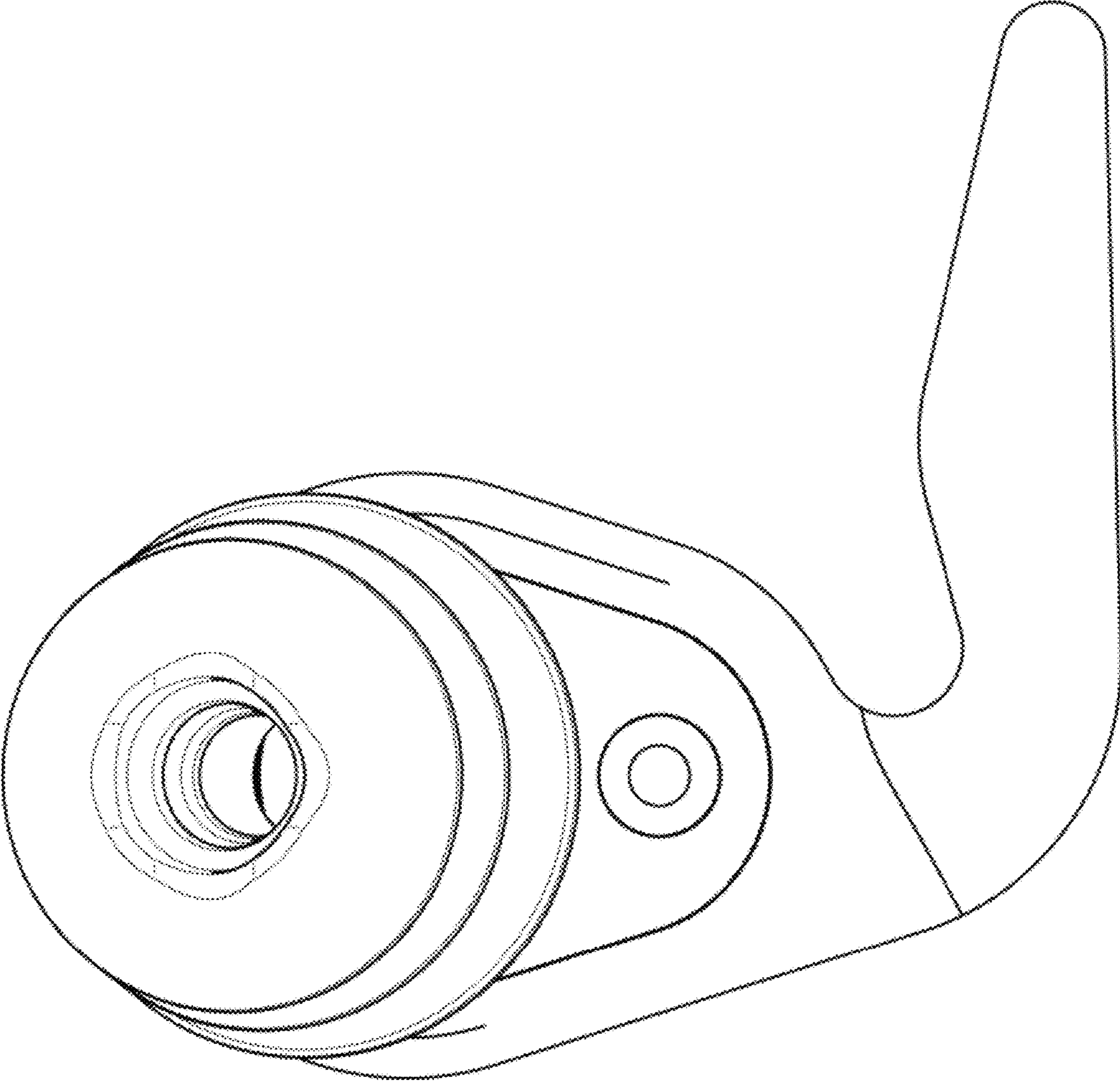

1.6

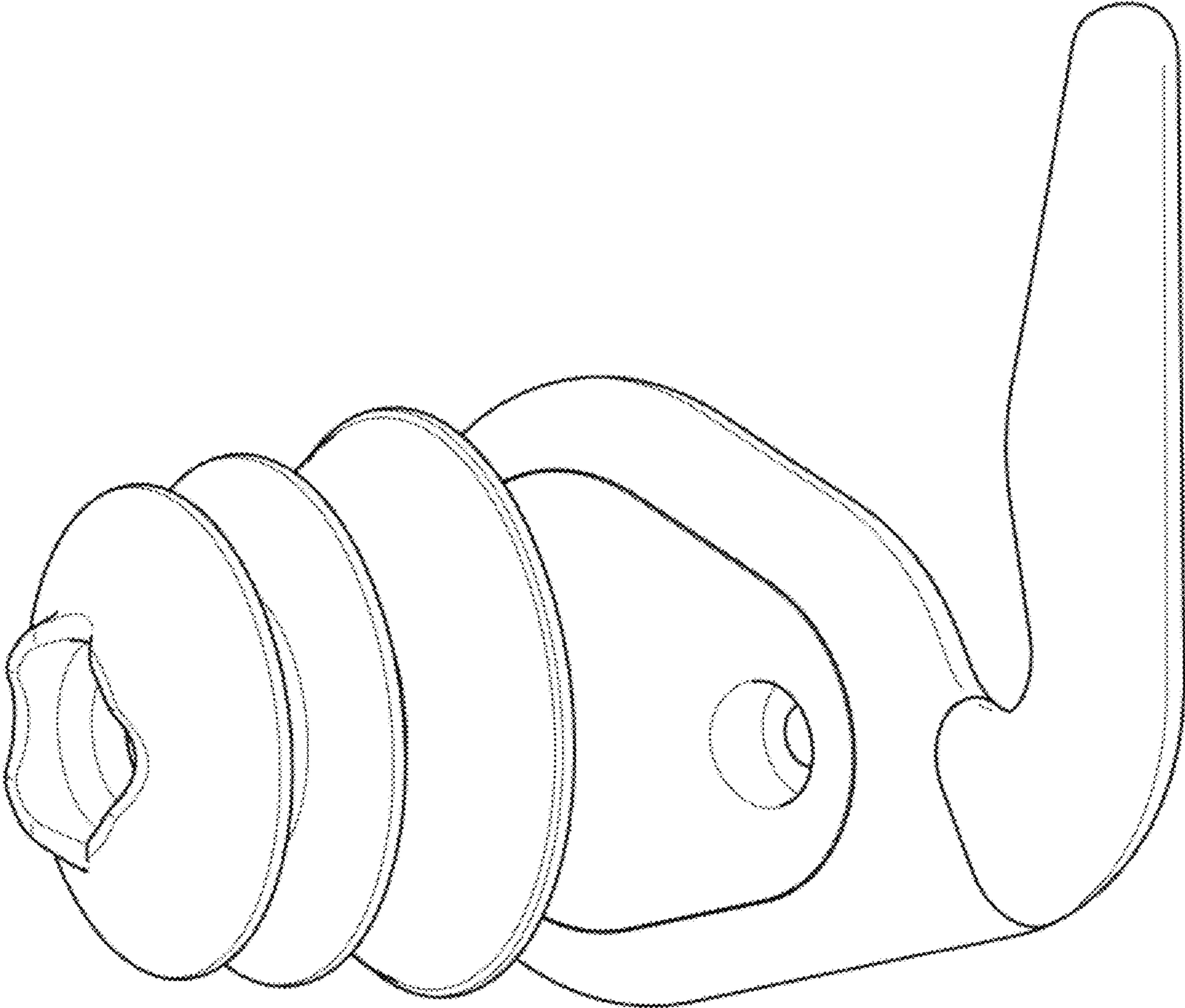

1.7

