



US00D788899S

(12) **United States Design Patent** (10) **Patent No.:** **US D788,899 S**
Valentino et al. (45) **Date of Patent:** **** Jun. 6, 2017**

(54) **FRAGRANCE DIFFUSER BULB**
 (71) Applicant: **Bath & Body Works Brand Management, Inc.**, Reynoldsburg, OH (US)
 (72) Inventors: **Heidi Valentino**, New York, NY (US); **Kathryn Ludwig**, Brooklyn, NY (US)
 (73) Assignee: **Bath & Body Works Brand Management, Inc.**, Reynoldsburg, OH (US)

D510,271 S * 10/2005 Mero D9/538
 D515,933 S * 2/2006 Mero D9/538
 D522,119 S 5/2006 Baraky et al.
 D530,210 S * 10/2006 Chisholm D9/538
 D532,314 S * 11/2006 Todd D9/552
 7,228,981 B2 * 6/2007 Chisholm B65D 1/0223
 215/379
 D553,504 S * 10/2007 Goto D9/549
 7,277,626 B2 10/2007 Pesu et al.
 D559,694 S * 1/2008 Le Bras-Brown D9/538
 D583,038 S 12/2008 Kay et al.
 D603,709 S * 11/2009 Lepoitevin D9/520

(Continued)

Primary Examiner — Sandra Snapp

(74) *Attorney, Agent, or Firm* — Andrus Intellectual Property Law, LLP

(**) Term: **15 Years**

(21) Appl. No.: **29/536,461**

(22) Filed: **Aug. 17, 2015**

(51) **LOC (10) Cl.** **28-99**

(52) **U.S. Cl.**
USPC **D23/366**

(58) **Field of Classification Search**
 USPC D23/355–369; D28/5, 6; 261/DIG. 17, 261/DIG. 42, DIG. 47, DIG. 55, DIG. 65, 261/DIG. 70, DIG. 88, DIG. 89; 392/386, 392/389, 394, 395, 403; 239/34, 44, 45, 239/53, 56; D9/522, 549, 556
 CPC ... A61L 9/02; A61L 9/03; A61L 9/034; A61L 9/04; A61L 9/12; A61L 9/032; A61L 9/122; A61L 9/127; A61L 9/22
 See application file for complete search history.

(56) **References Cited**

U.S. PATENT DOCUMENTS

D314,136 S * 1/1991 Malvoisin D9/502
 D344,236 S * 2/1994 Drounau D9/545
 D430,659 S 9/2000 Zaragoza et al.
 6,236,807 B1 5/2001 Ruffolo et al.
 D463,290 S * 9/2002 Wiggins D9/557
 D497,422 S 10/2004 Wirthman et al.
 D498,780 S * 11/2004 Su D16/202

(57) **CLAIM**

The ornamental design for a fragrance diffuser bulb, as shown and described.

DESCRIPTION

FIG. 1 is a perspective view of our new and ornamental design for a fragrance diffuser bulb;
 FIG. 2 is a front elevation view thereof, wherein the rear elevation view is identical to the front elevation view;
 FIG. 3 is a side elevation view thereof, wherein the fragrance diffuser bulb has been rotated to the right by 45 degrees with respect to the front elevation view;
 FIG. 4 is a left side elevation view thereof, wherein the right side elevation view is identical to the left side elevation view;
 FIG. 5 is a top view thereof;
 FIG. 6 is a bottom view thereof; and,
 FIG. 7 is a front elevation view thereof, showing the fragrance diffuser bulb use with an electrical fragrance diffuser.

The broken lines in the figures are directed to environment and are for illustrative purposes only; the broken lines form no part of the claimed design.

1 Claim, 6 Drawing Sheets

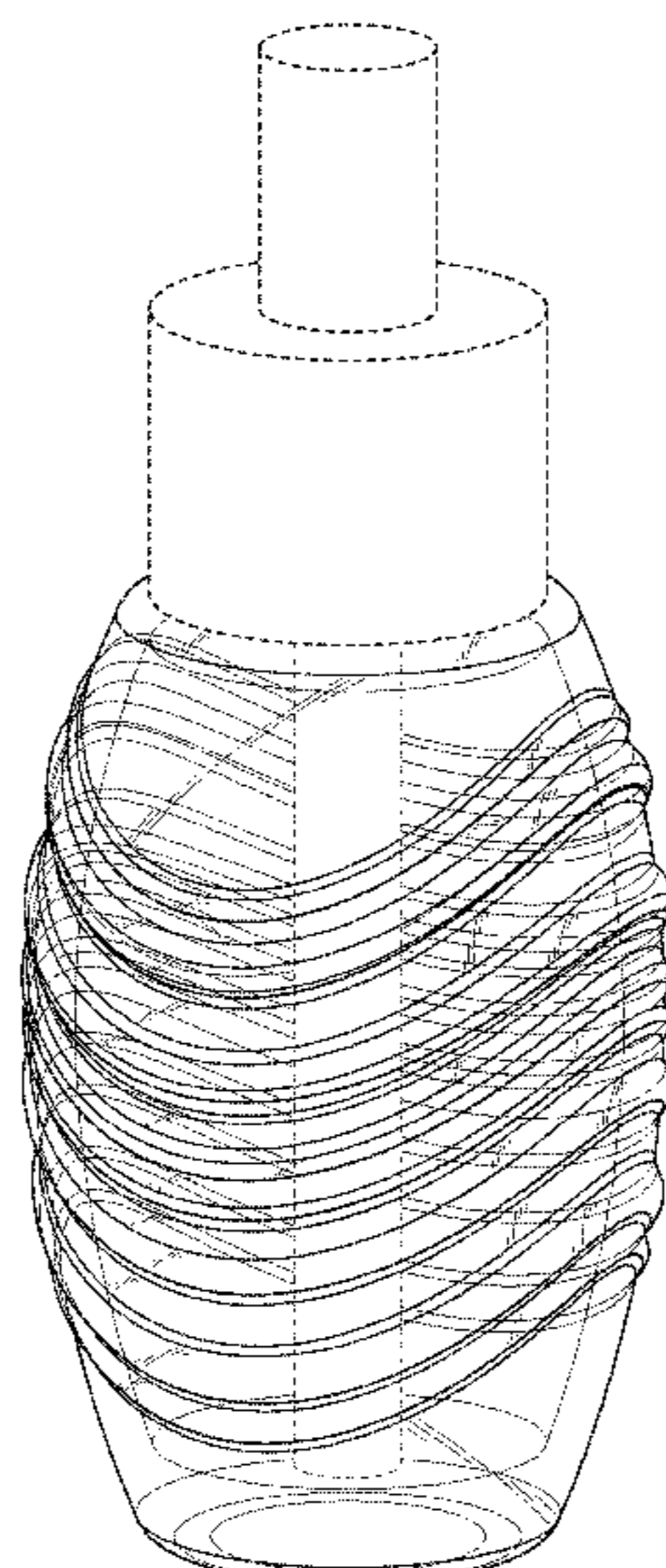

(56)

References Cited

U.S. PATENT DOCUMENTS

RE41,055 E * 12/2009 Choke-arpornchai D9/516
D606,643 S 12/2009 Butler et al.
D619,464 S * 7/2010 Langley D9/522
D642,923 S * 8/2011 Newton D9/522
D642,924 S * 8/2011 Newton D9/443
D643,296 S * 8/2011 Newton D9/522
D647,608 S 10/2011 Young et al.
D656,681 S * 3/2012 Reisler D29/101.4
D657,040 S 4/2012 Young et al.
8,301,019 B2 10/2012 Smith et al.
D672,861 S 12/2012 Adair et al.
D672,862 S 12/2012 Adair et al.
D686,721 S 7/2013 Wirz
D694,587 S * 12/2013 Slocumb D7/590
D738,734 S * 9/2015 Cripe D9/538
D742,234 S * 11/2015 Cripe D9/516

* cited by examiner

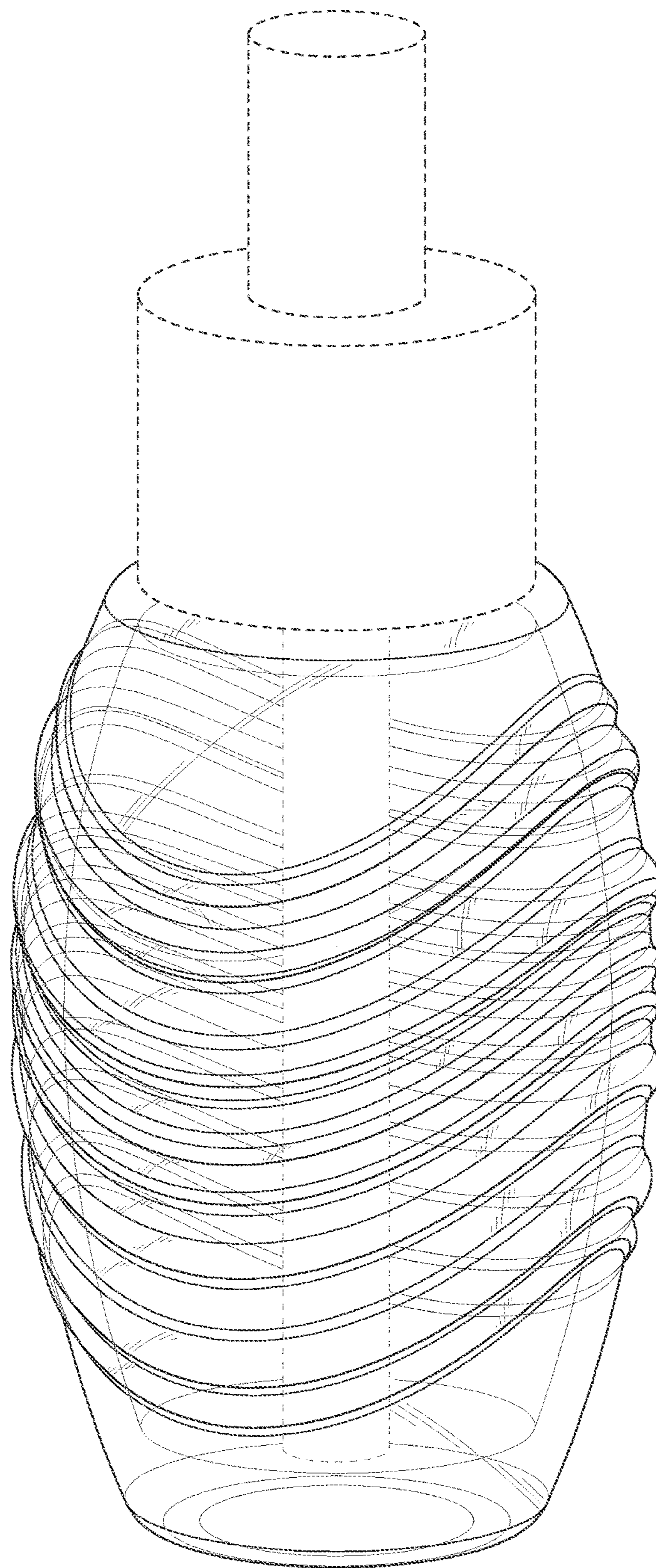

FIG. 1

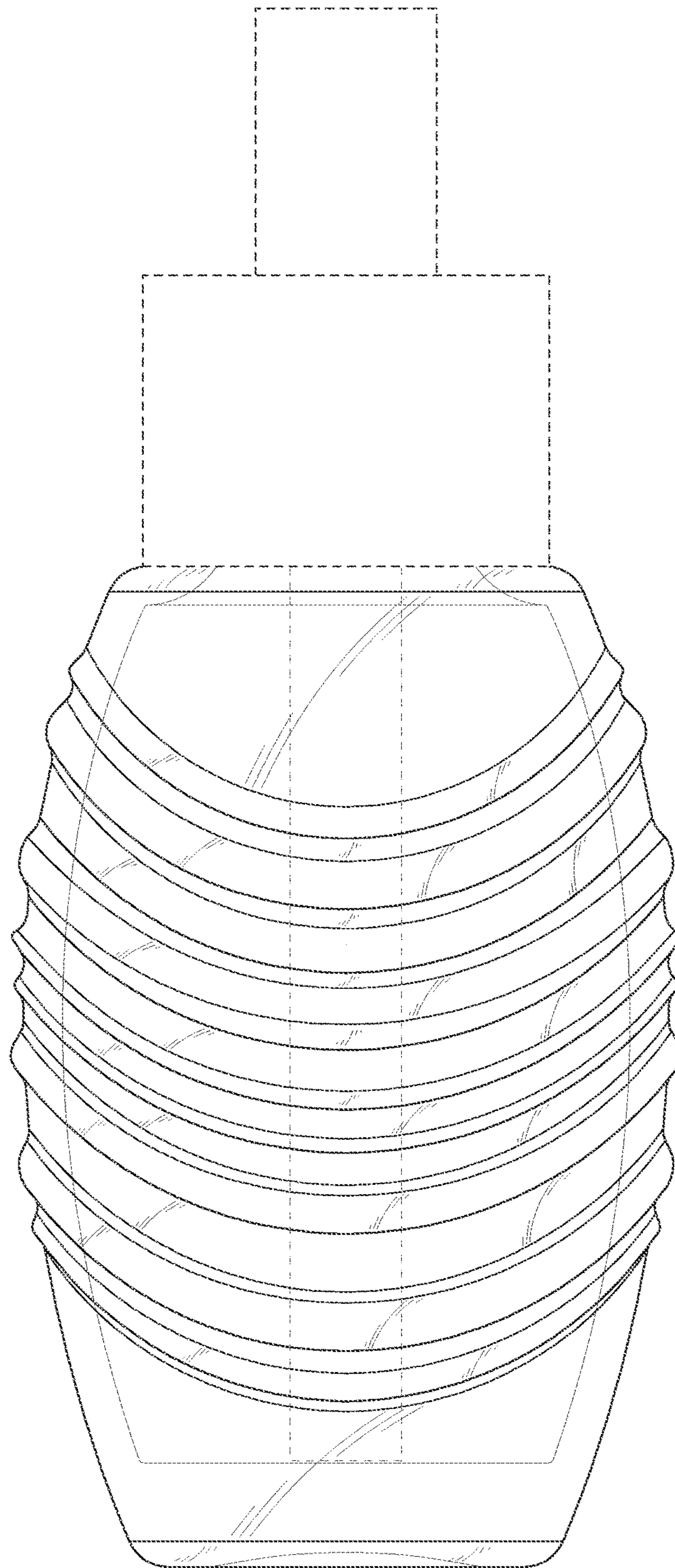

FIG. 2

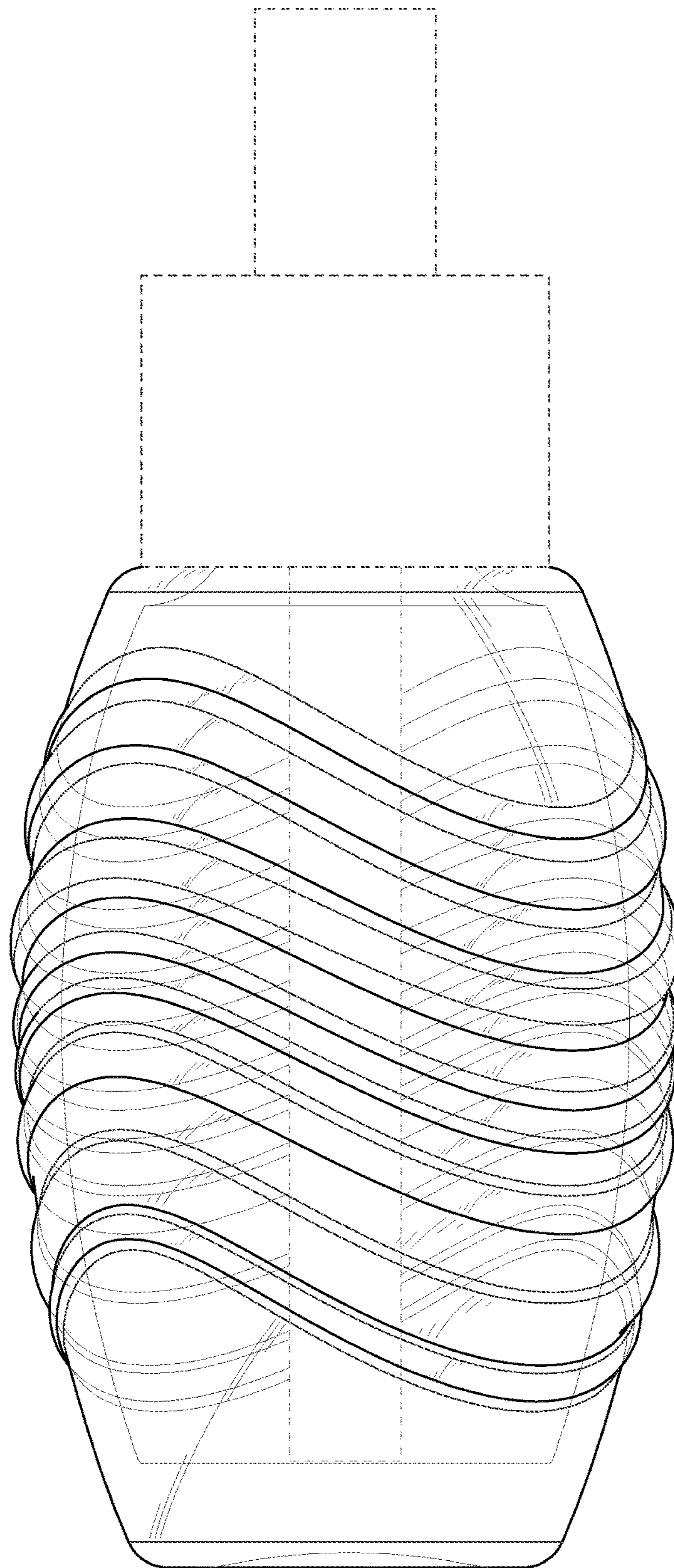

FIG. 3

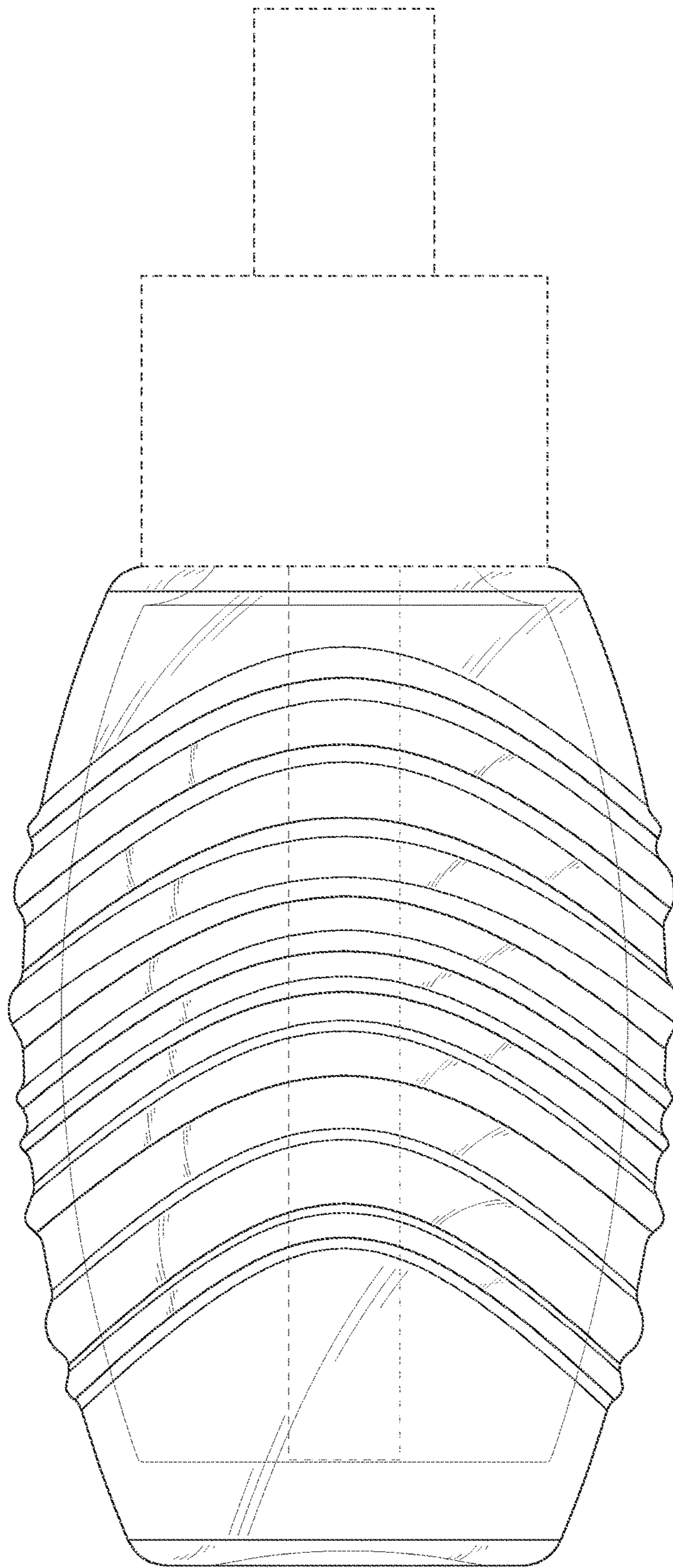

FIG. 4

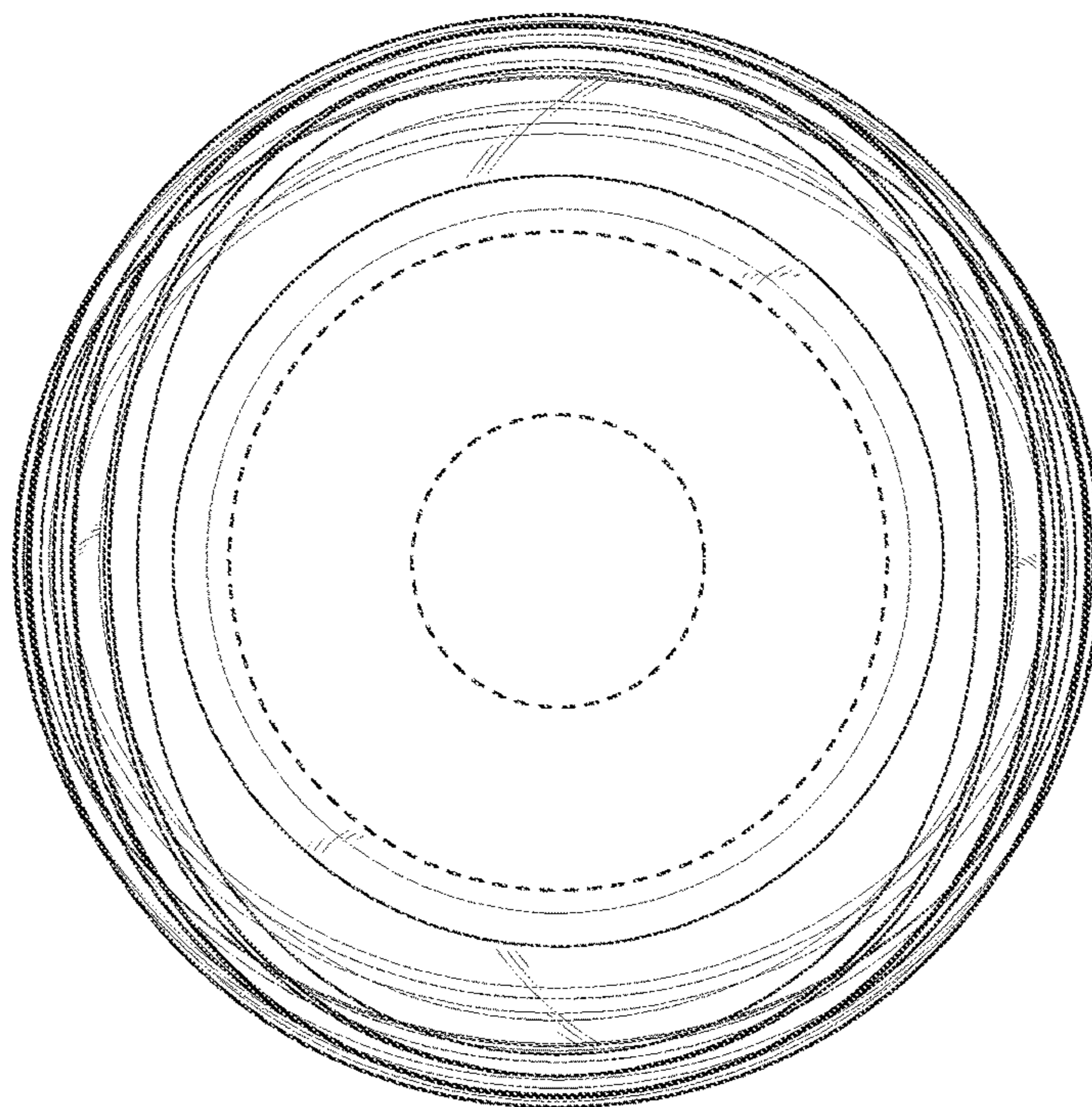

FIG. 5

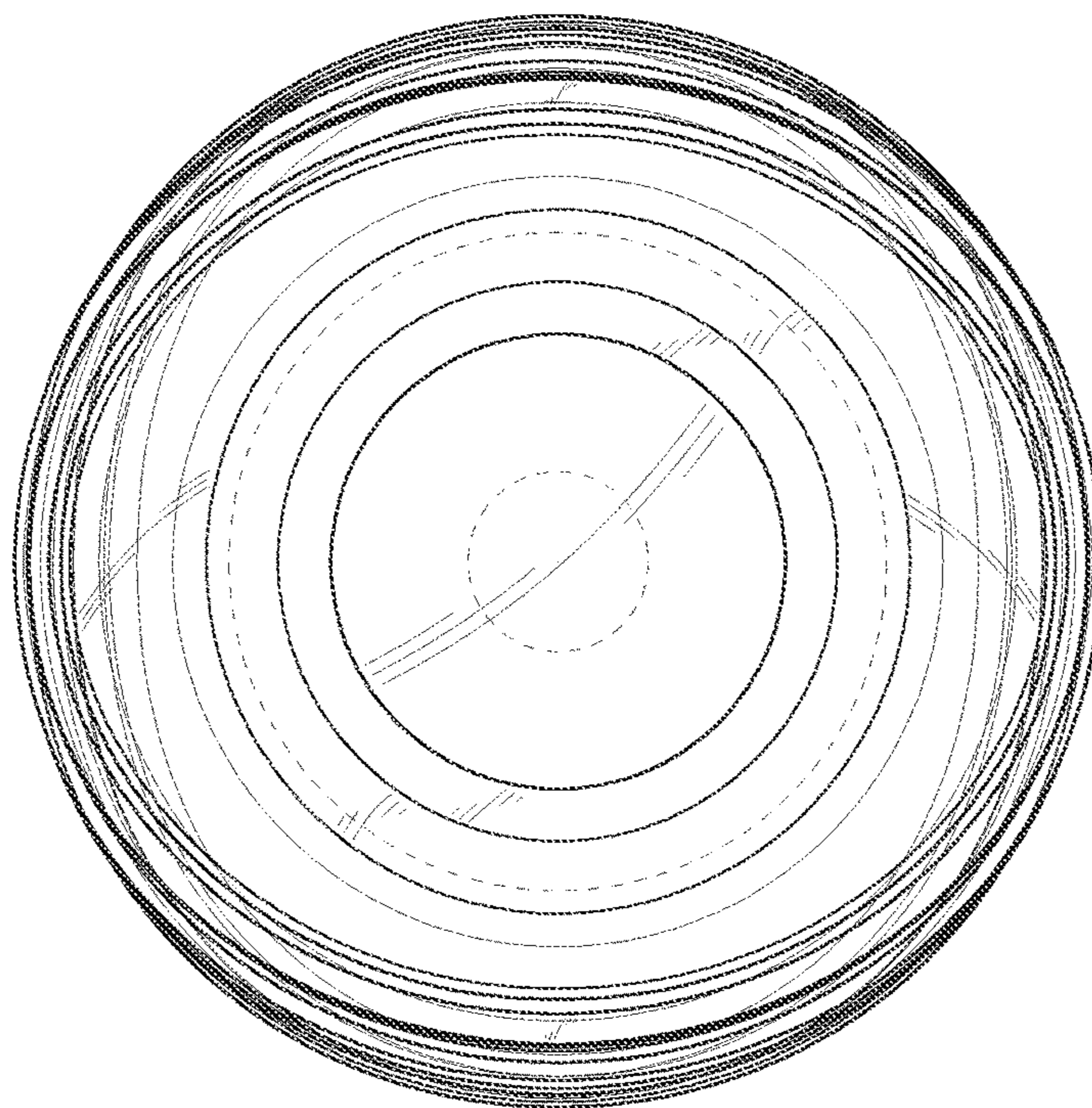

FIG. 6

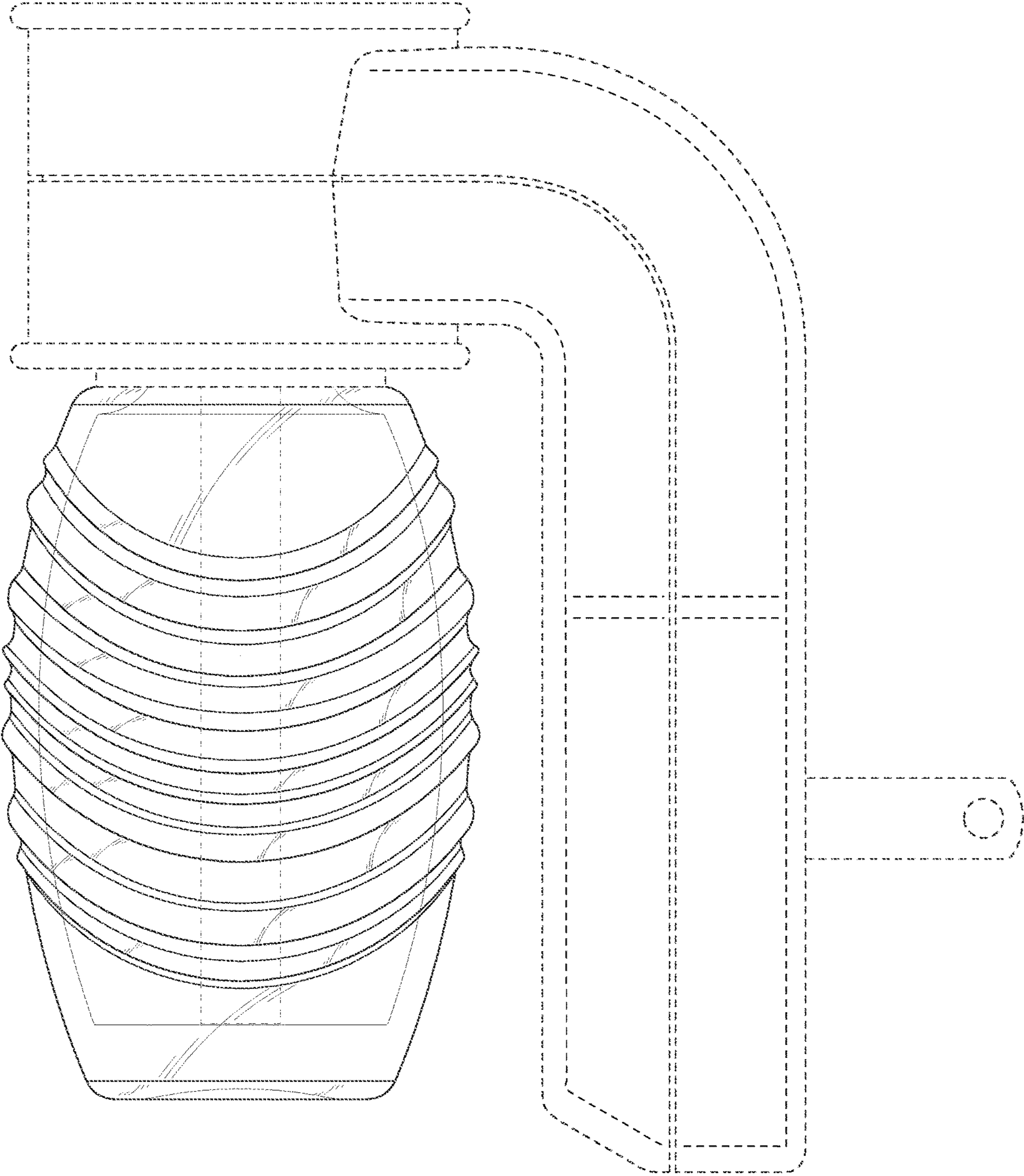

FIG. 7

UNITED STATES PATENT AND TRADEMARK OFFICE
CERTIFICATE OF CORRECTION

PATENT NO. : D788,899 S
APPLICATION NO. : 29/536461
DATED : June 6, 2017
INVENTOR(S) : Heidi Valentino and Kathryn Ludwig

Page 1 of 1

It is certified that error appears in the above-identified patent and that said Letters Patent is hereby corrected as shown below:

On the Title Page

Under the heading "DESCRIPTION", FIG. 7, Line 2, the phrase "bulb use" should read --bulb in use--.

Signed and Sealed this
Eighth Day of August, 2017



Joseph Matal
*Performing the Functions and Duties of the
Under Secretary of Commerce for Intellectual Property and
Director of the United States Patent and Trademark Office*