



US00D788889S

(12) **United States Design Patent**
Hull et al.

(10) **Patent No.:** **US D788,889 S**
(45) **Date of Patent:** **** Jun. 6, 2017**

- (54) **CIRCULAR GRATE**
- (71) Applicant: **Oatey Co.**, Cleveland, OH (US)
- (72) Inventors: **Eric G. Hull**, Avon Lake, OH (US);
Paul R. Metcalfe, Solon, OH (US);
Scott E. Urban, University Heights,
OH (US)
- (73) Assignee: **Oatey Co.**, Cleveland, OH (US)
- (**) Term: **15 Years**
- (21) Appl. No.: **29/566,457**
- (22) Filed: **May 31, 2016**
- (51) **LOC (10) Cl.** **23-01**
- (52) **U.S. Cl.**
USPC **D23/261**
- (58) **Field of Classification Search**
USPC D23/259–262, 268, 267, 397, 400–401;
D25/149–152; 210/164
CPC E03F 5/06; E03F 5/0407; E03F 5/042
See application file for complete search history.

- 2,803,348 A * 8/1957 Bingham E03F 5/06
210/498
- D191,184 S 8/1961 Scholz
- 3,406,829 A * 10/1968 Vande Bosche E03F 5/0407
210/164
- 3,854,151 A * 12/1974 Boudewyn E03F 5/0407
4/286
- D244,854 S 6/1977 Salamone
- 4,136,010 A 1/1979 Pilie
- 4,207,632 A 6/1980 Savell, Jr. et al.
- 4,257,892 A 3/1981 Boersma
- 4,261,824 A * 4/1981 Cuschera E03F 5/06
210/164
- 4,423,527 A 1/1984 Morris et al.
- 4,454,039 A 6/1984 McCoy
- D276,839 S 12/1984 McCoy
- 4,515,498 A 5/1985 Thomann et al.
- 5,130,016 A 7/1992 Gavin

(Continued)

Primary Examiner — Eric Goodman
Assistant Examiner — Amy Wierenga
(74) *Attorney, Agent, or Firm* — Baker & Hostetler LLP

(57) **CLAIM**

I claim the ornamental design for a circular grate, as shown and described.

(56) **References Cited**

U.S. PATENT DOCUMENTS

- D22,739 S * 8/1893 Gregory D23/397
- D26,525 S 1/1897 Nason
- 873,120 A 12/1907 Dunstan
- 979,182 A 12/1910 MacDonald
- 1,622,652 A 3/1927 Lang
- 1,805,816 A 5/1931 Fleming
- 2,161,783 A 6/1939 Huber
- 2,190,532 A 2/1940 Lukomski
- 2,222,807 A 11/1940 Burr
- 2,269,522 A 1/1942 Dreibuss et al.
- 2,324,545 A 7/1943 Svirsky
- 2,689,017 A 9/1954 Schmid
- 2,701,027 A 2/1955 Scoville
- 2,783,852 A 3/1957 Sisk

DESCRIPTION

FIG. 1 is a top perspective view of a circular grate;
FIG. 2 is a bottom perspective view thereof;
FIG. 3 is a top plan view thereof;
FIG. 4 is a bottom plan view thereof;
FIG. 5 is a front elevational view thereof, the rear elevational view being a mirror image of the grate of FIG. 5; and,
FIG. 6 is a right side elevational view thereof, the left side elevational view being a mirror image of the circular grate of FIG. 6.
The broken lines depict portions of the circular grate that form no part of the claim.

1 Claim, 5 Drawing Sheets

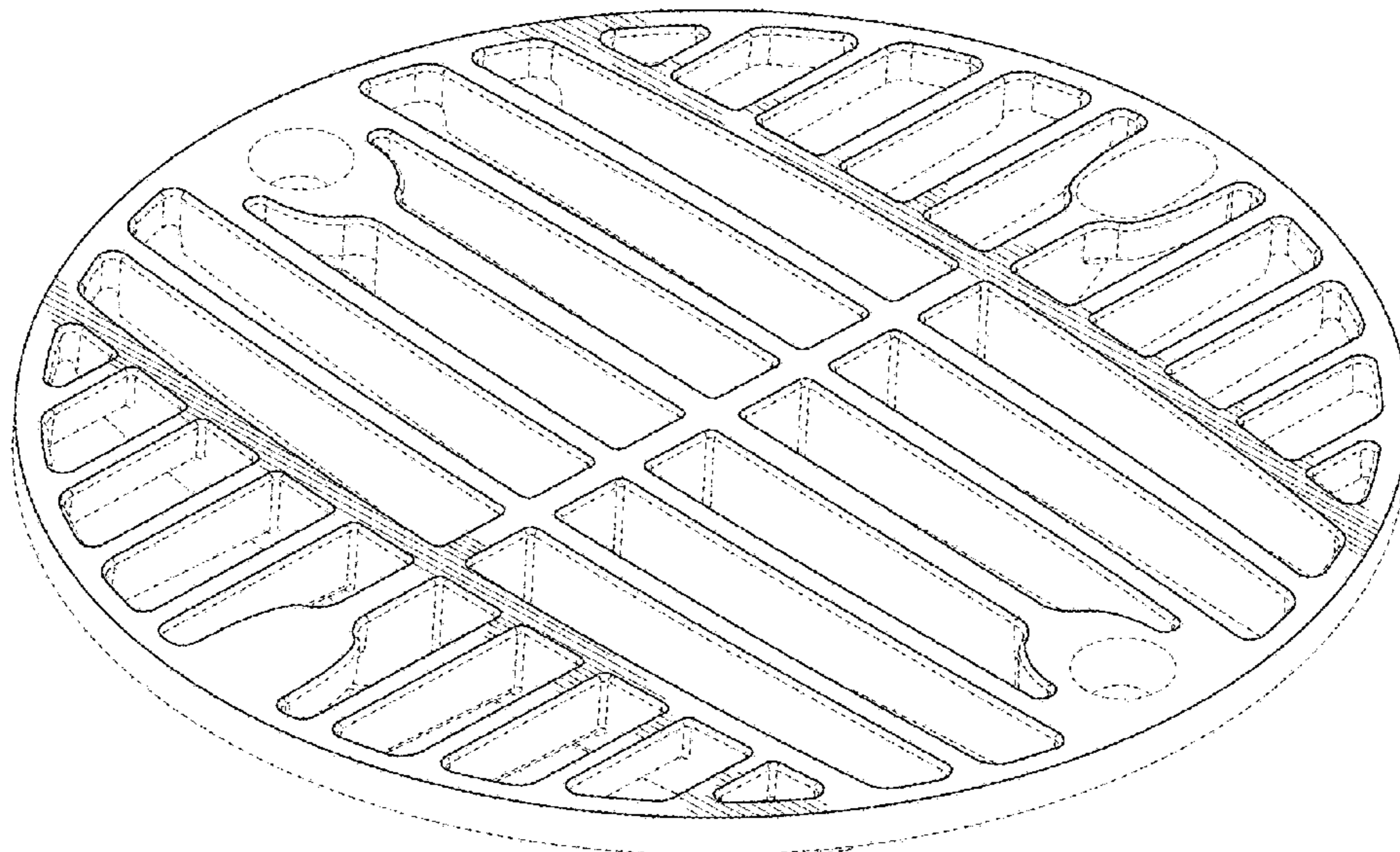

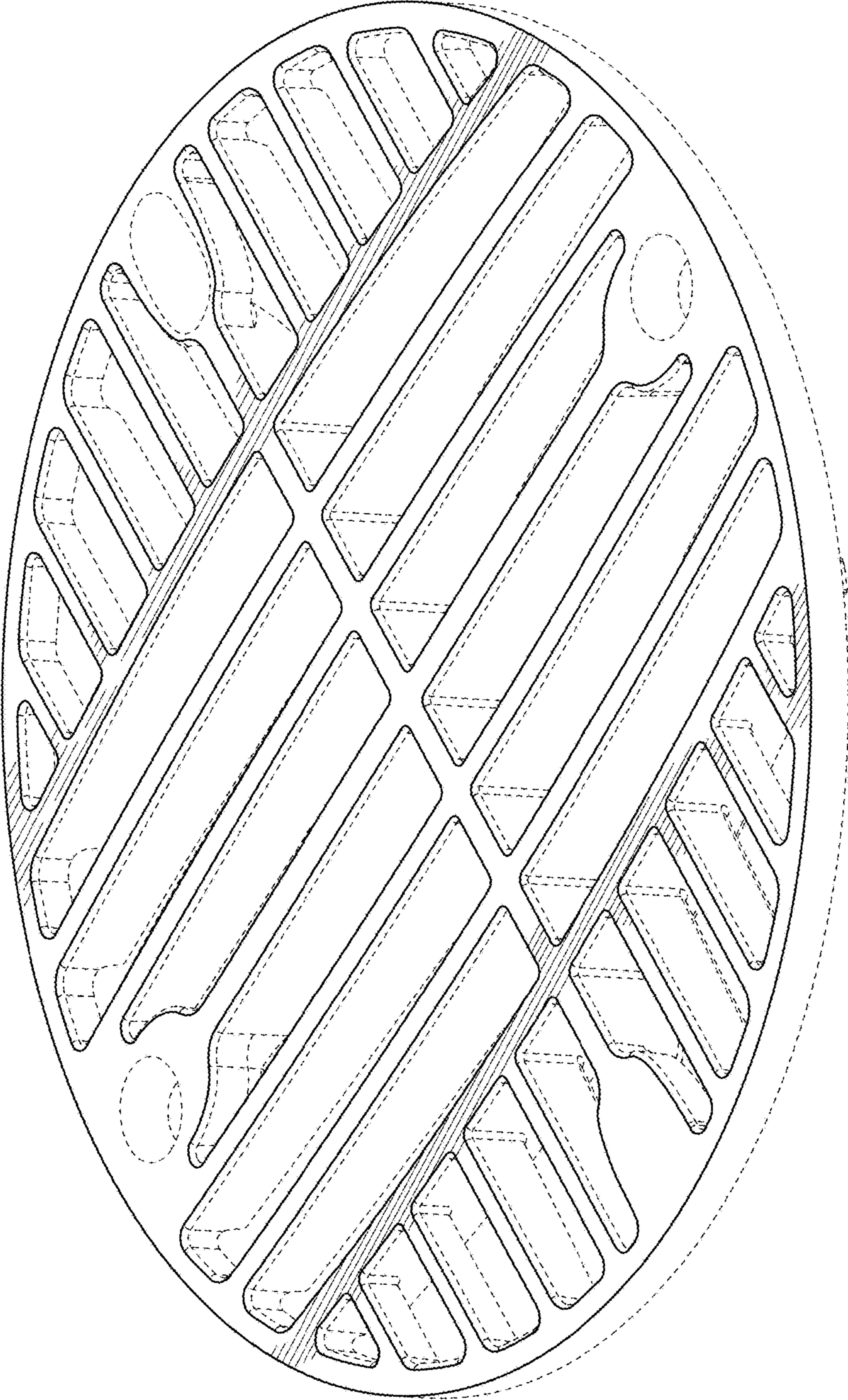

FIG. 1

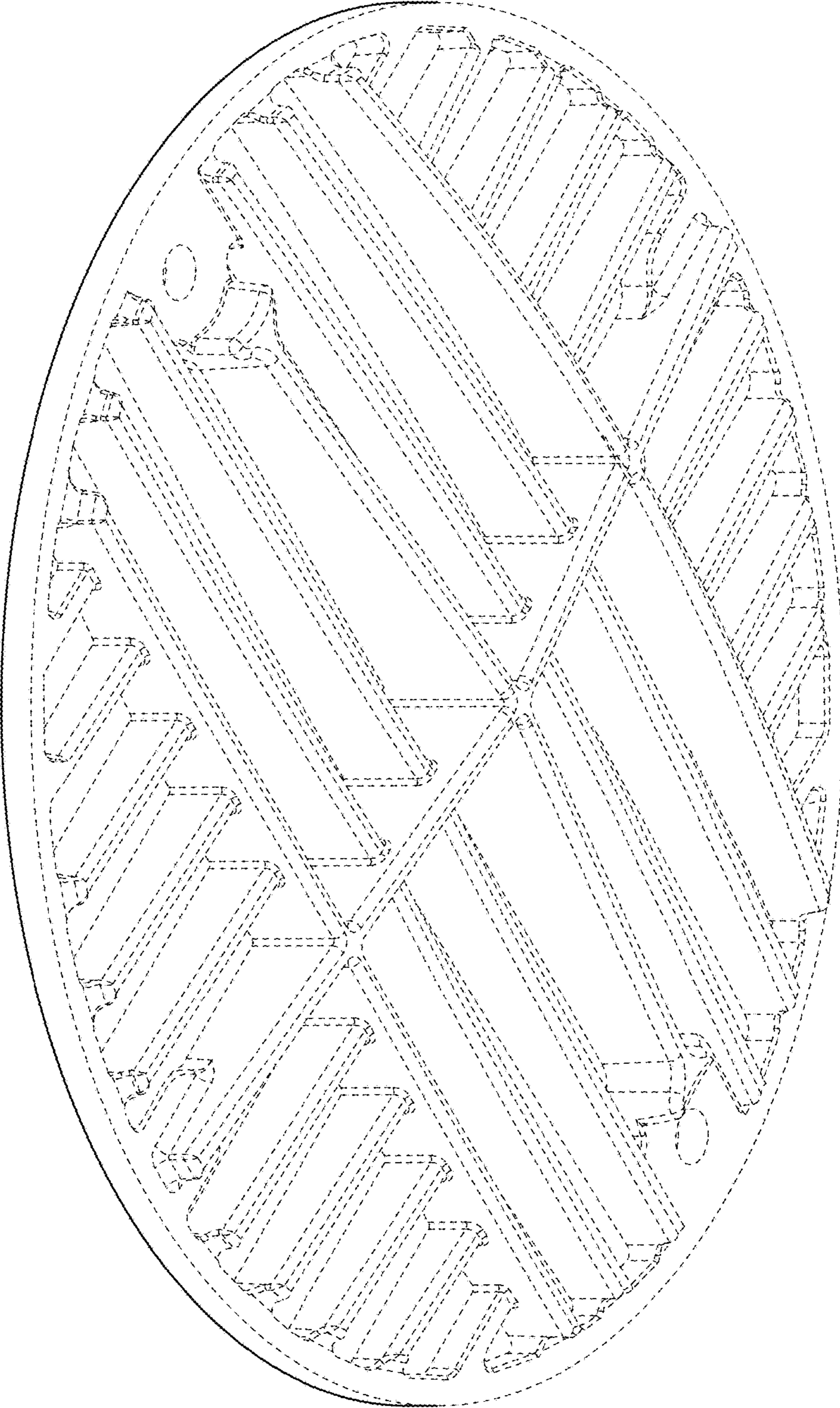

FIG. 2

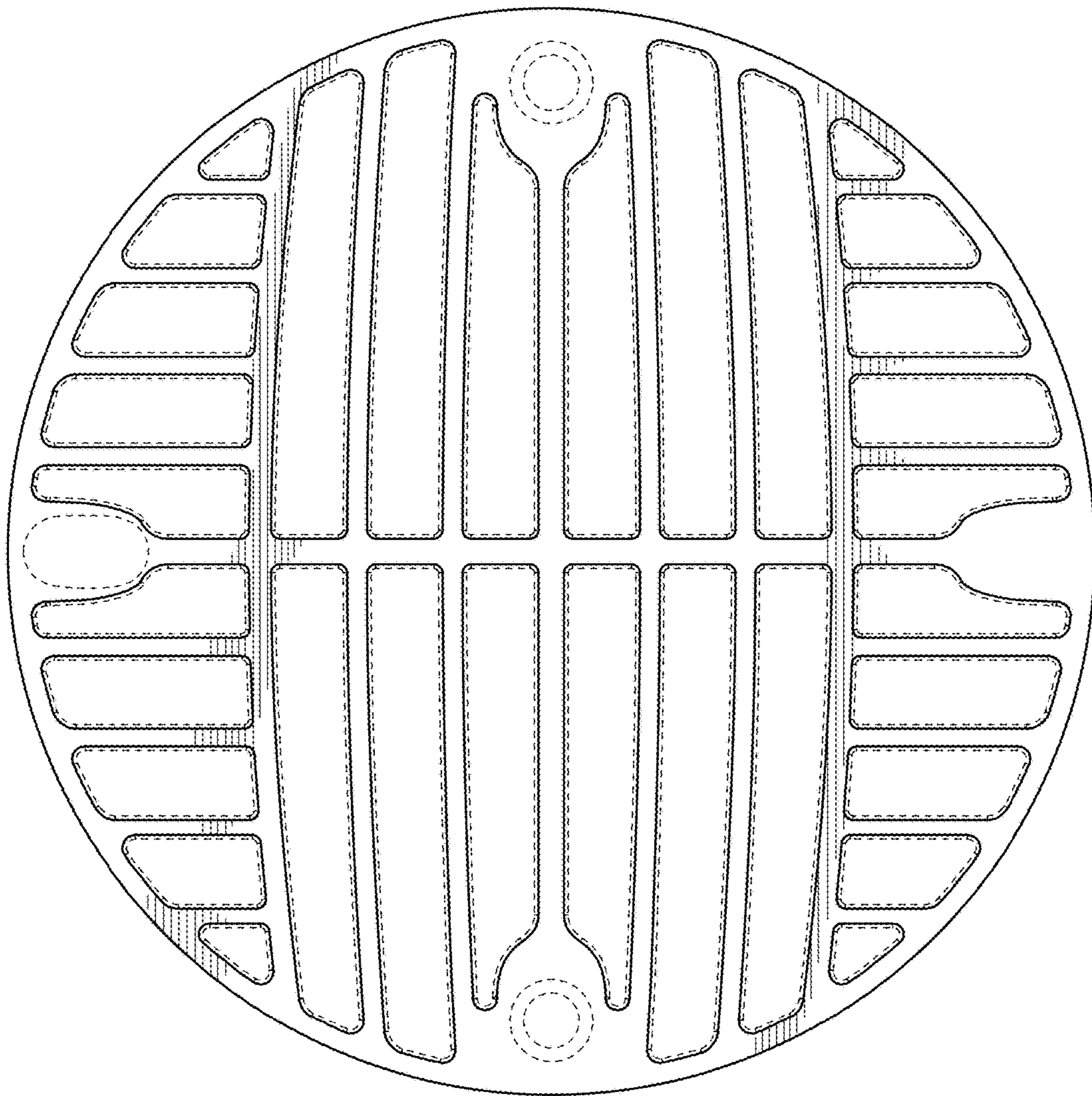

FIG. 3

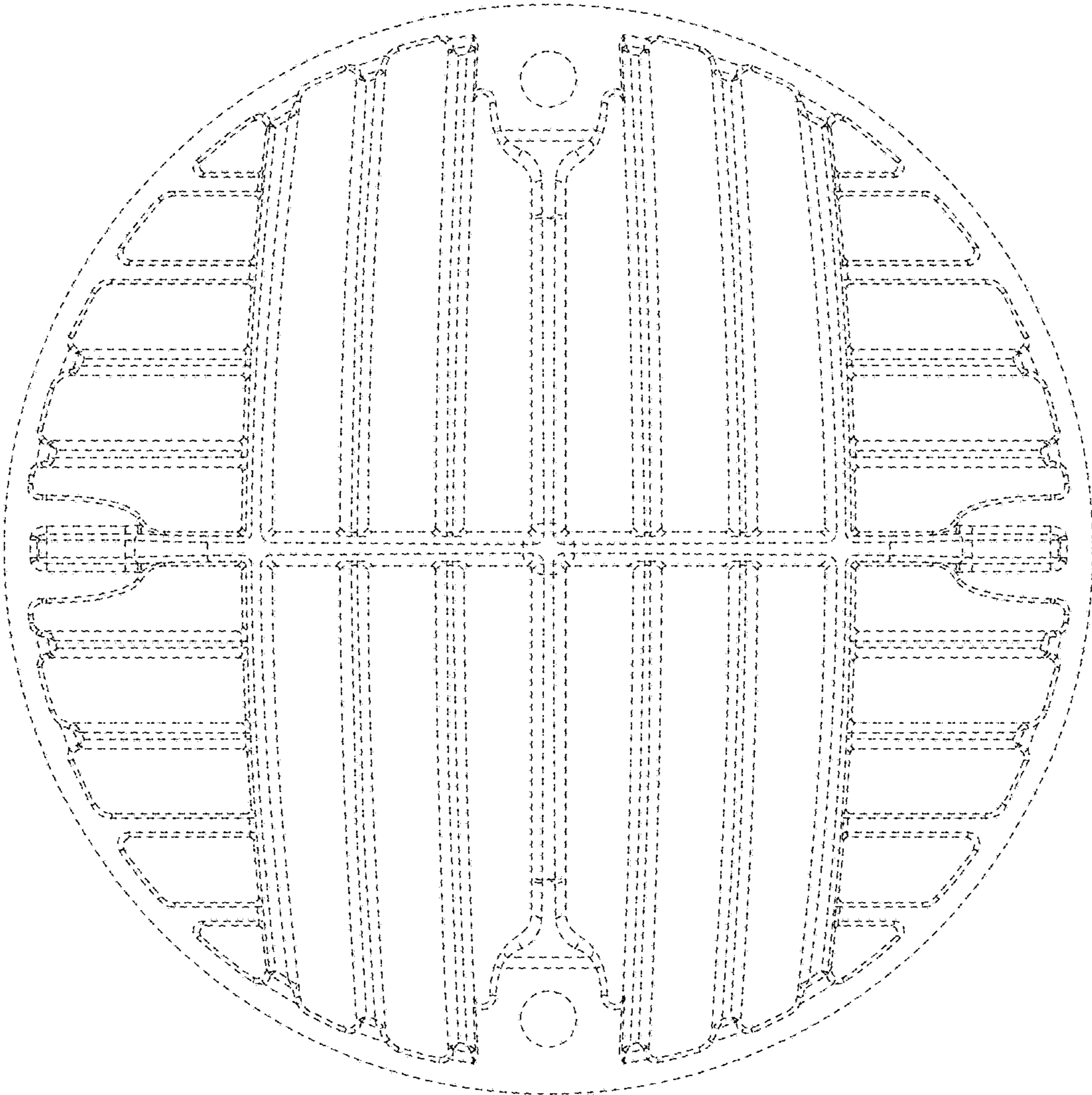

FIG. 4

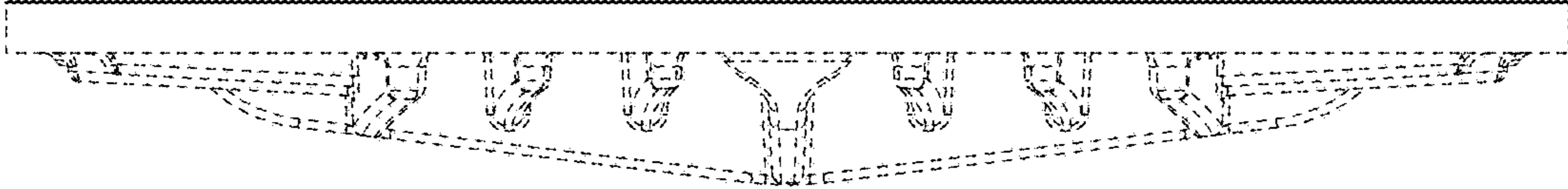

FIG. 5

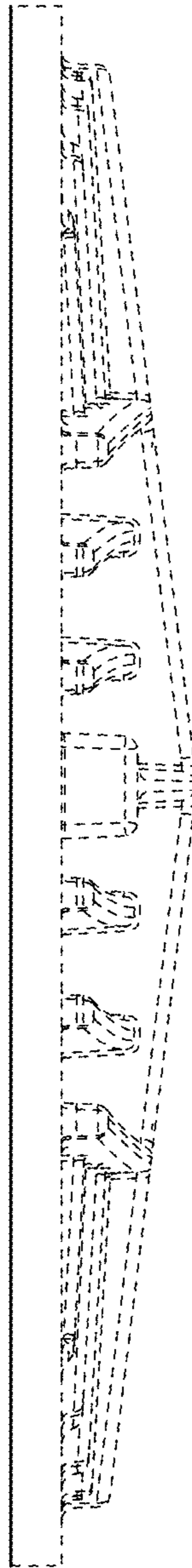

FIG. 6