



US00D788875S

(12) **United States Design Patent** (10) **Patent No.:** **US D788,875 S**
Arnedo Vera et al. (45) **Date of Patent:** **** Jun. 6, 2017**

(54) **GUN STOCK**

(71) Applicant: **GAMO OUTDOOR, S.L.**, Sant Boi de Llobregat (ES)

(72) Inventors: **Julian Arnedo Vera**, Sant Boi de Llobregat (ES); **Victor Tresserras Torre**, Sant Boi de Llobregat (ES)

(73) Assignee: **GAMO OUTDOOR, S.L.**, Sant Boi de Llobregat (Barcelona) (ES)

(**) Term: **15 Years**

(21) Appl. No.: **35/500,368**

(22) Filed: **Dec. 9, 2015**

(80) **Hague Agreement Data**

Int. Filing Date: **Dec. 9, 2015**

Int. Reg. No.: **DM/088473**

Int. Reg. Date: **Dec. 9, 2015**

Int. Reg. Pub. Date: **Dec. 18, 2015**

(51) **LOC (10) Cl.** **22-00**

(52) **U.S. Cl.**
USPC **D22/108**

(58) **Field of Classification Search**
USPC D22/108
CPC F41C 23/20
See application file for complete search history.

(56) **References Cited**

U.S. PATENT DOCUMENTS

| | | | |
|----------------|---------|------------------------|------------|
| D631,526 S * | 1/2011 | Torre | D22/108 |
| D701,283 S * | 3/2014 | Vera | D22/108 |
| D712,996 S * | 9/2014 | Tresserras Torre | D22/108 |
| D744,055 S * | 11/2015 | Bitz | D22/108 |
| 9,429,387 B1 * | 8/2016 | Barfoot | F41C 23/20 |

* cited by examiner

Primary Examiner — George D. Kirschbaum

(74) *Attorney, Agent, or Firm* — Knobbe, Martens, Olson & Bear, LLP

(57) **CLAIM**

Ornamental design for a gun stock, as shown and described.

DESCRIPTION

1. Gun stock

FIG. 1.1 is an enlarged front view of a gun stock according to my new design;

FIG. 1.2 is a top view thereof;

FIG. 1.3 is a bottom view thereof;

FIG. 1.4 is a right view thereof;

FIG. 1.5 is a perspective view thereof;

FIG. 1.6 is a left view thereof; and

FIG. 1.7 is an enlarged back view thereof.

The broken lines that appear in FIGS. 1.1-1.7 depict environmental features that form no part of the claimed design.

1 Claim, 7 Drawing Sheets

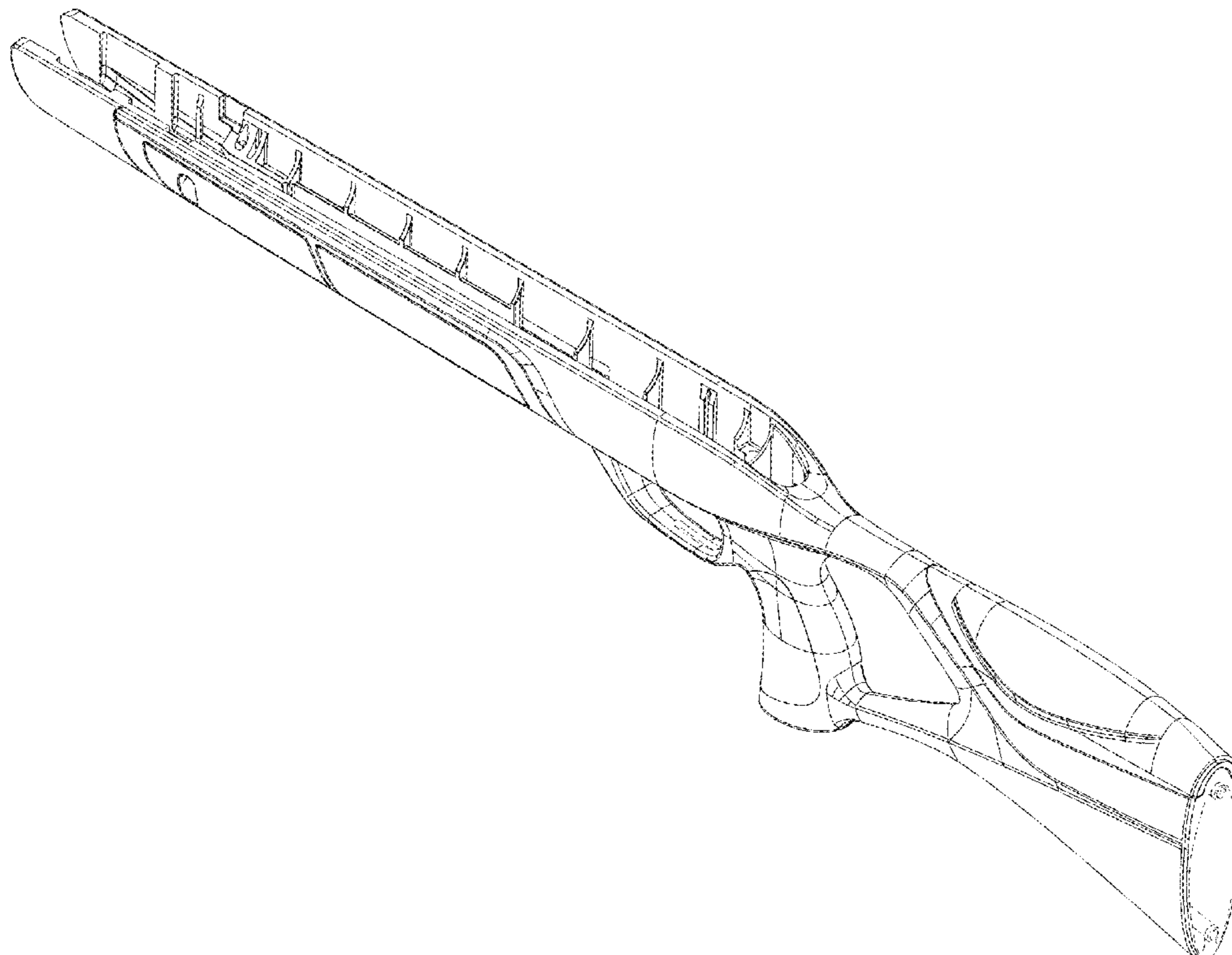

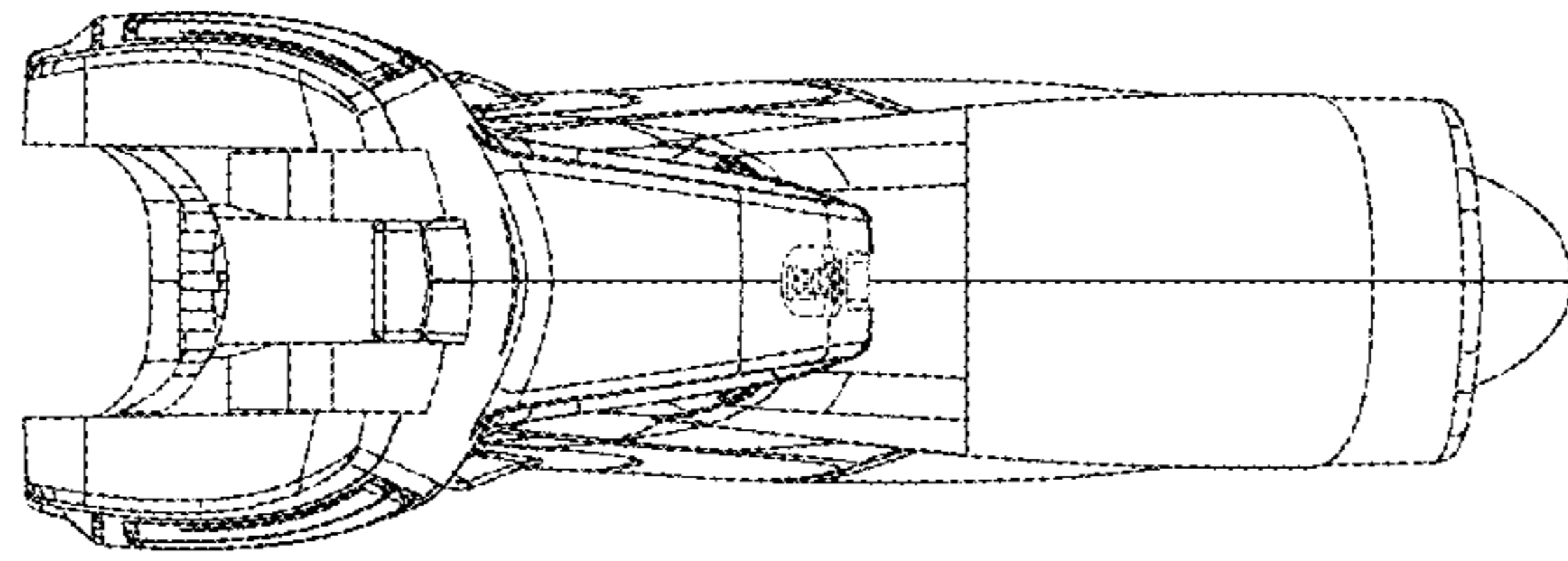

FIG. 1.1

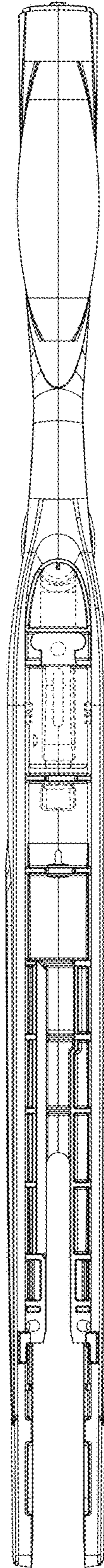

FIG. 1.2

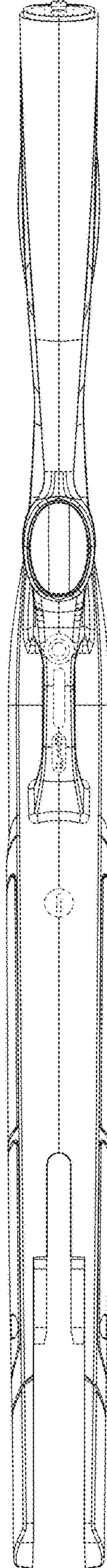

FIG. 1.3

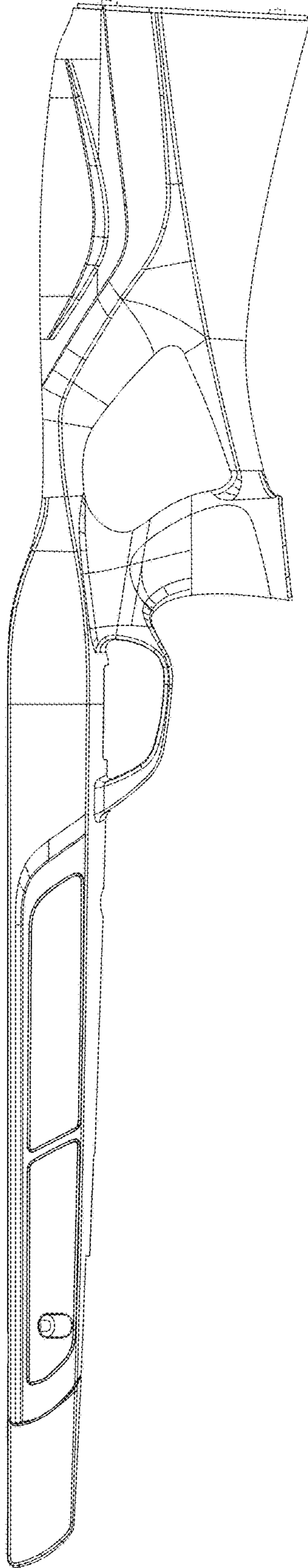

FIG. 1.4

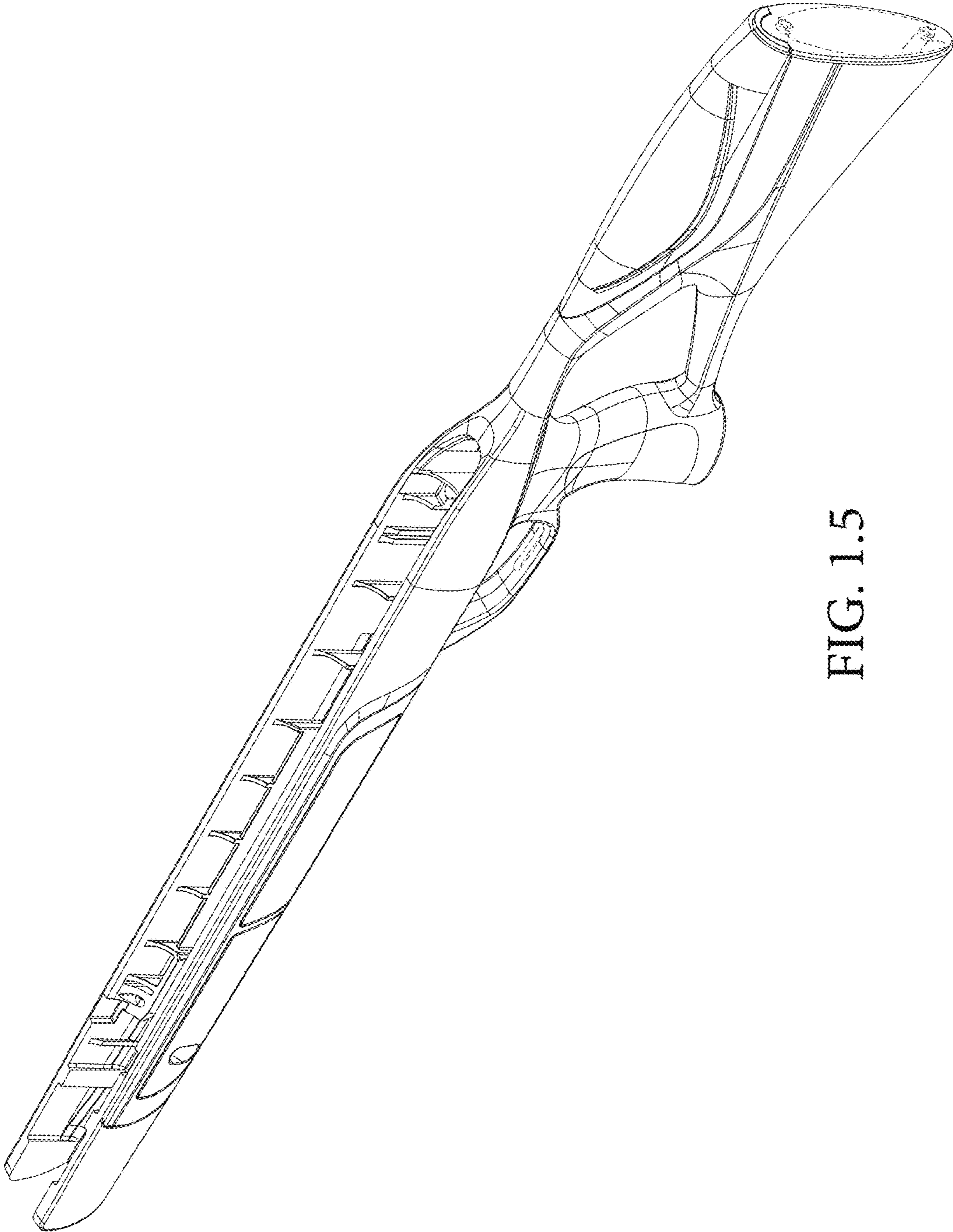

FIG. 1.5

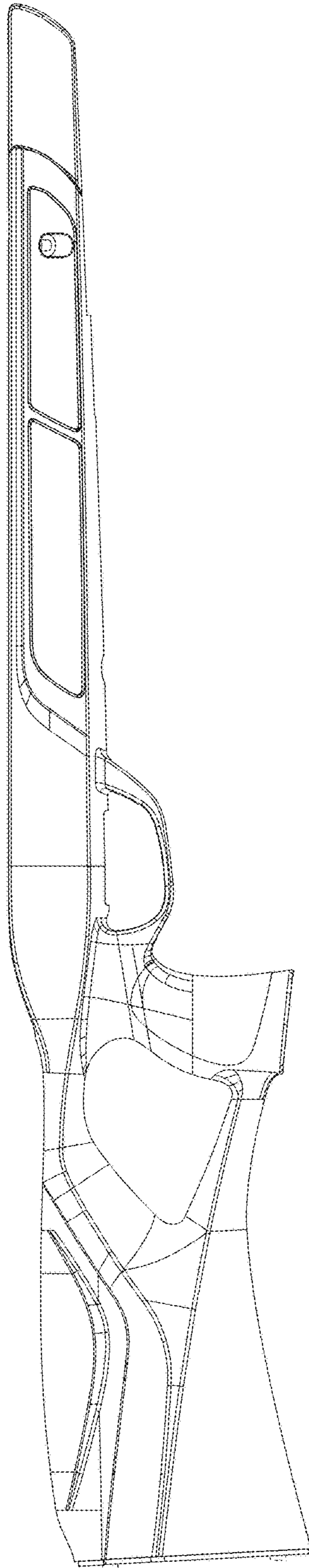

FIG. 1.6

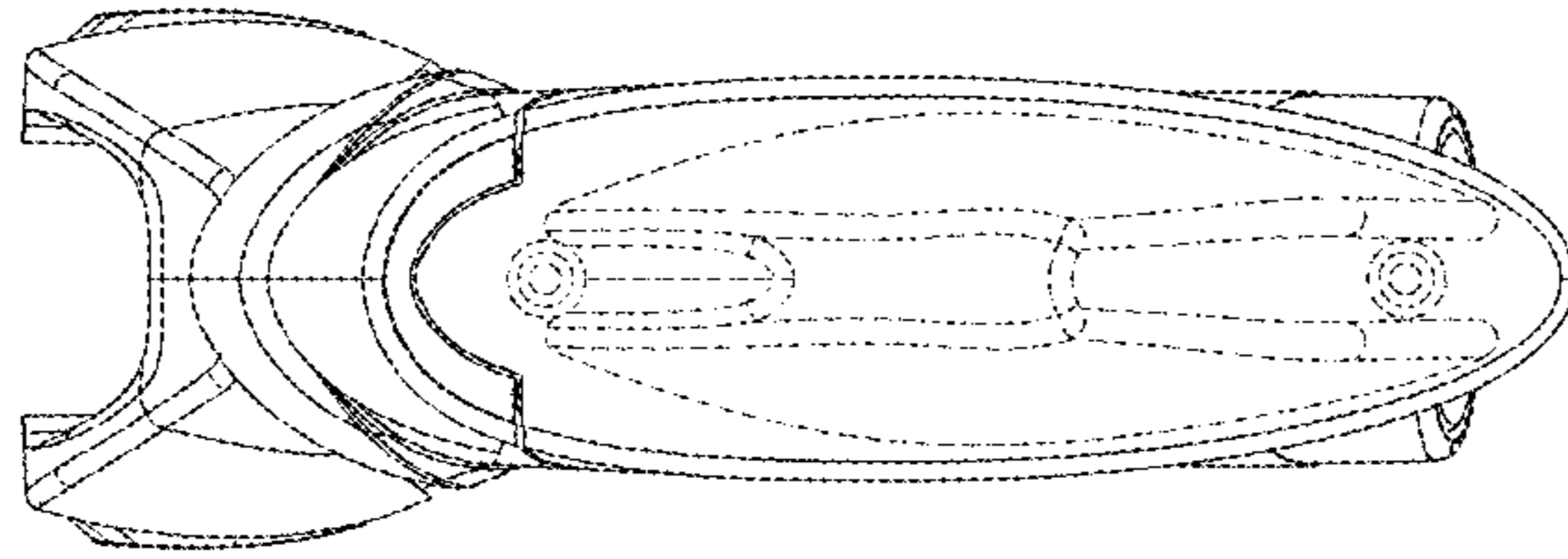

FIG. 1.7