



US00D788821S

(12) **United States Design Patent** (10) **Patent No.:** **US D788,821 S**  
**Nguyen et al.** (45) **Date of Patent:** **\*\* Jun. 6, 2017**

(54) **ELECTRONIC DEVICE**

17/00; G06F 19/00; G07F 17/32; H04M 1/00

(71) Applicant: **Vocollect, Inc.**, Pittsburgh, PA (US)

See application file for complete search history.

(72) Inventors: **Vinh-Duy Thai Nguyen**, Pittsburgh, PA (US); **Bryan DiPiazza**, Belle Vernon, PA (US); **Matthew Shope**, Belle Vernon, PA (US); **Richard Sharbaugh**, New Kensington, PA (US); **Timothy Fox**, Pittsburgh, PA (US); **Fernando Aguirre-Petrilli**, Pittsburgh, PA (US)

(56) **References Cited**

U.S. PATENT DOCUMENTS

6,658,202	B1 *	12/2003	Battaglia .....	H04N 1/2158 358/909.1
6,733,329	B2	5/2004	Yang	
6,807,591	B2 *	10/2004	Kao .....	G11B 20/10527 710/74
D506,209	S *	6/2005	Leong .....	D14/191
D511,519	S *	11/2005	Bone .....	D14/480.1
7,052,287	B1	5/2006	Ni et al.	
7,074,052	B1	7/2006	Ni et al.	
D529,044	S *	9/2006	Andre .....	D14/203.3
D537,808	S *	3/2007	Lee .....	D14/203.7

(Continued)

(73) Assignee: **Vocollect, Inc.**, Pittsburgh, PA (US)

*Primary Examiner* — Prabhakar Deshmukh

(\*\*) Term: **15 Years**

(74) *Attorney, Agent, or Firm* — Additon, Higgins & Pendleton, P.A.

(21) Appl. No.: **29/561,378**

(22) Filed: **Apr. 15, 2016**

**Related U.S. Application Data**

(63) Continuation of application No. 29/513,411, filed on Dec. 30, 2014, now Pat. No. Des. 754,206.

(57) **CLAIM**

The ornamental design for an electronic device, as shown and described.

(51) **LOC (10) Cl.** ..... **14-03**

(52) **U.S. Cl.**  
USPC ..... **D14/496**; D14/203.3

**DESCRIPTION**

(58) **Field of Classification Search**  
USPC ..... D14/496, 401, 435, 474, 483, 217, 137, D14/138, 160, 168, 356, 203.1–203.8, D14/507; 345/156, 169, 173–179, 905; 715/727–729, 864; 710/1, 5, 8; 713/1, 713/600; 455/1.1, 1.7, 73, 344–347, 93, 455/95, 3.01–3.06, 550.1, 573.1; 370/342–344; 369/1, 2, 6–12; 463/43–47; 273/148 B  
CPC .... A63F 9/00; A63F 9/24; A63F 13/00; G06F

The present application is related to U.S. patent application Ser. No. 29/513,410 for an Electronic Device filed Dec. 30, 2014, now U.S. Pat. No. D754,205. Each of the foregoing patent application and patent is hereby incorporated by reference in its entirety.

FIG. 1 is a top-left-front perspective view of an electronic device, showing our new design.  
FIG. 2 is a top plan view of the electronic device.  
FIG. 3 is a bottom plan view of the electronic device.  
FIG. 4 is a right elevation view of the electronic device.  
FIG. 5 is a left elevation view of the electronic device.  
FIG. 6 is a front elevation view of the electronic device; and,  
FIG. 7 is a rear elevation view of the electronic device.

(Continued)

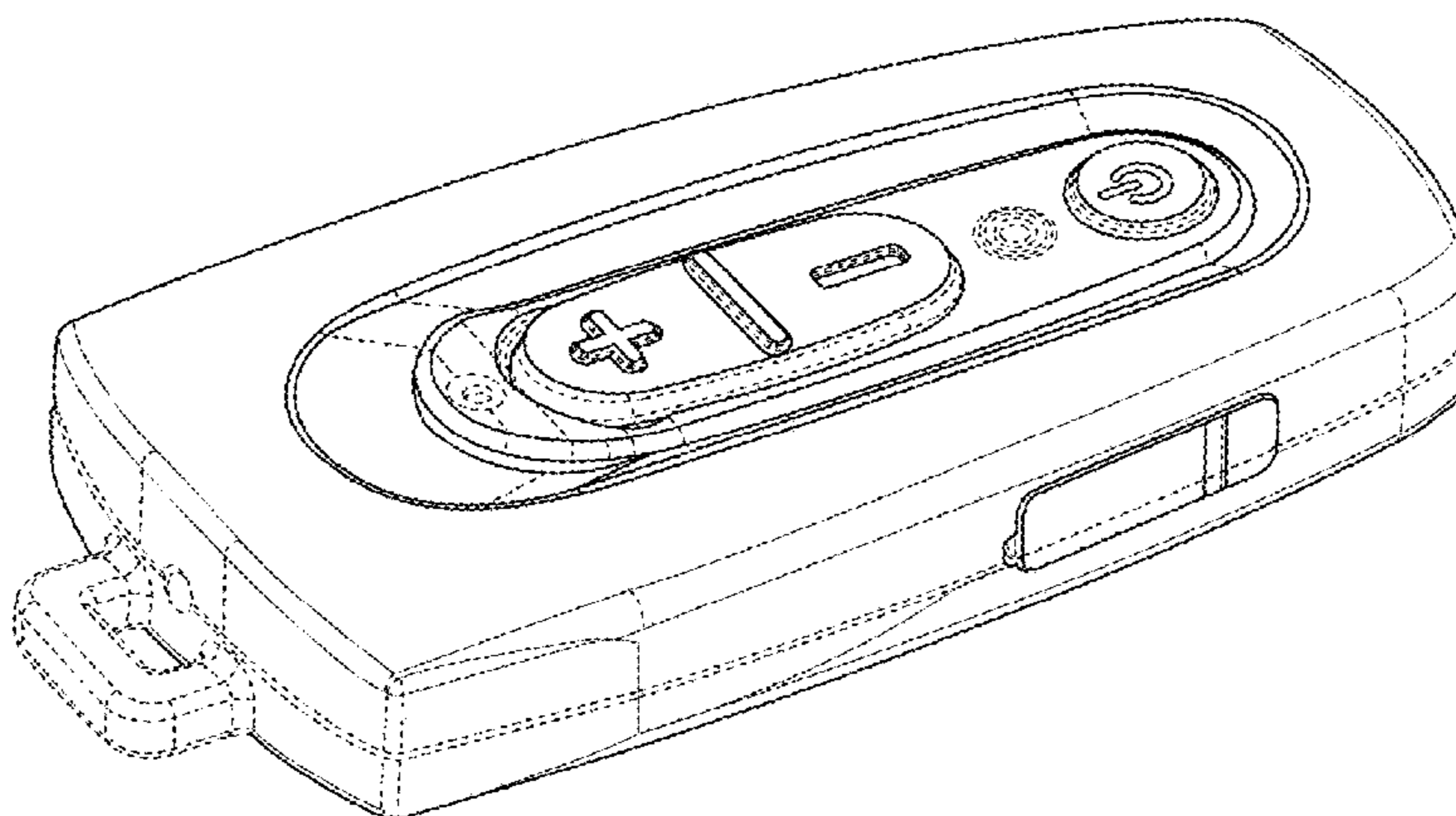

The broken lines indicate unclaimed portions and form no part of the claimed design.

**1 Claim, 7 Drawing Sheets**

(56)

**References Cited**

U.S. PATENT DOCUMENTS

7,203,529	B2 *	4/2007	Kim .....	H04N 1/2112 348/E7.079
D556,210	S	11/2007	Choi et al.	
D558,783	S *	1/2008	Andre .....	D14/496
D563,434	S	3/2008	Dai	
D592,227	S *	5/2009	Oh .....	D14/496
D597,068	S	7/2009	Whang	
D607,873	S *	1/2010	Lee .....	D14/203.3
7,856,255	B2 *	12/2010	Tsuchiya .....	G06F 1/1616 200/11 TW
D639,773	S *	6/2011	Kang .....	D14/203.3
D643,401	S	8/2011	Chen et al.	
D662,488	S	6/2012	Yeo	
D688,272	S	8/2013	Lee	
D688,706	S *	8/2013	Lee .....	D14/496
D702,732	S	4/2014	Wu	
D754,205	S	4/2016	Nguyen et al.	
D754,206	S	4/2016	Nguyen et al.	

\* cited by examiner

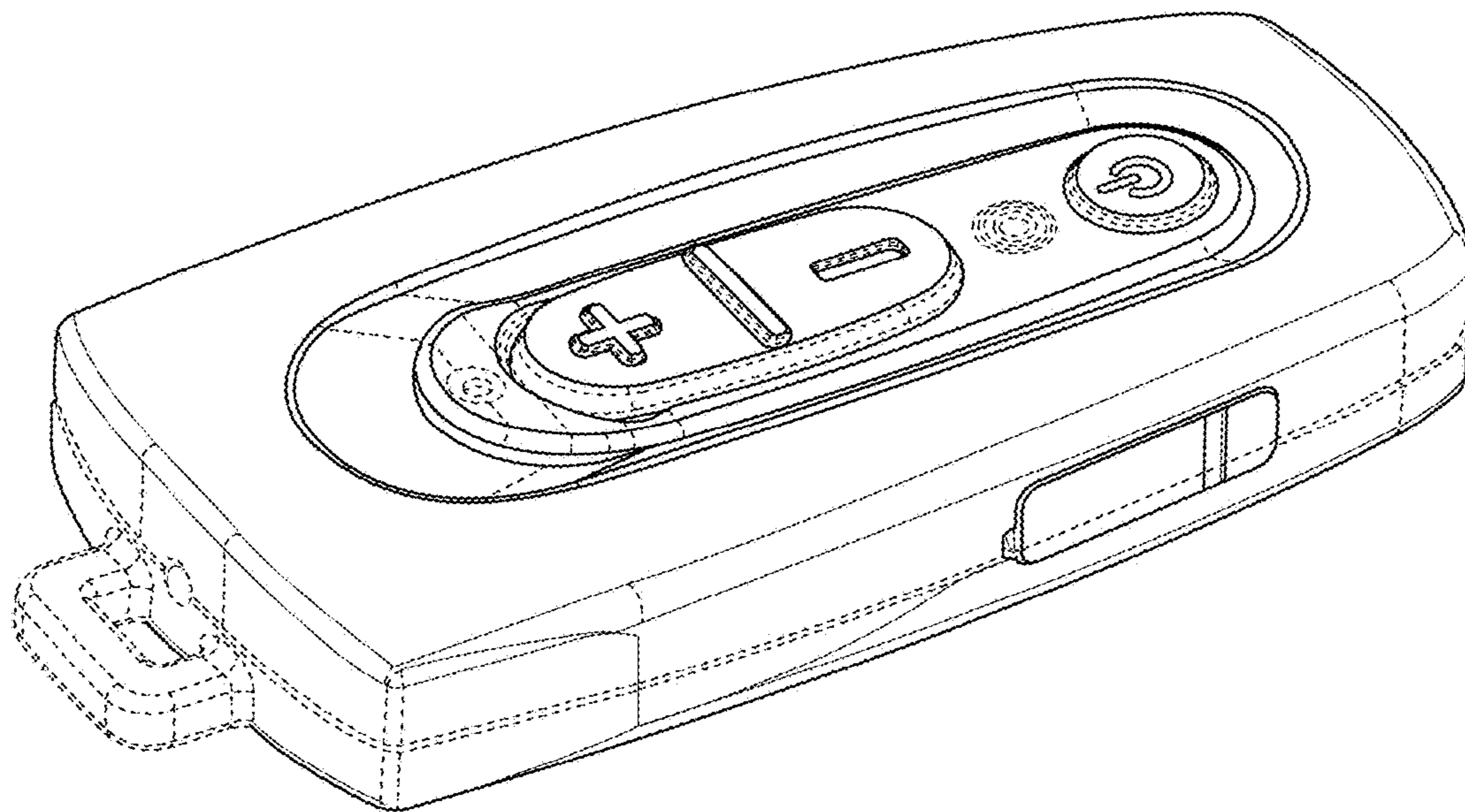

FIG. 1

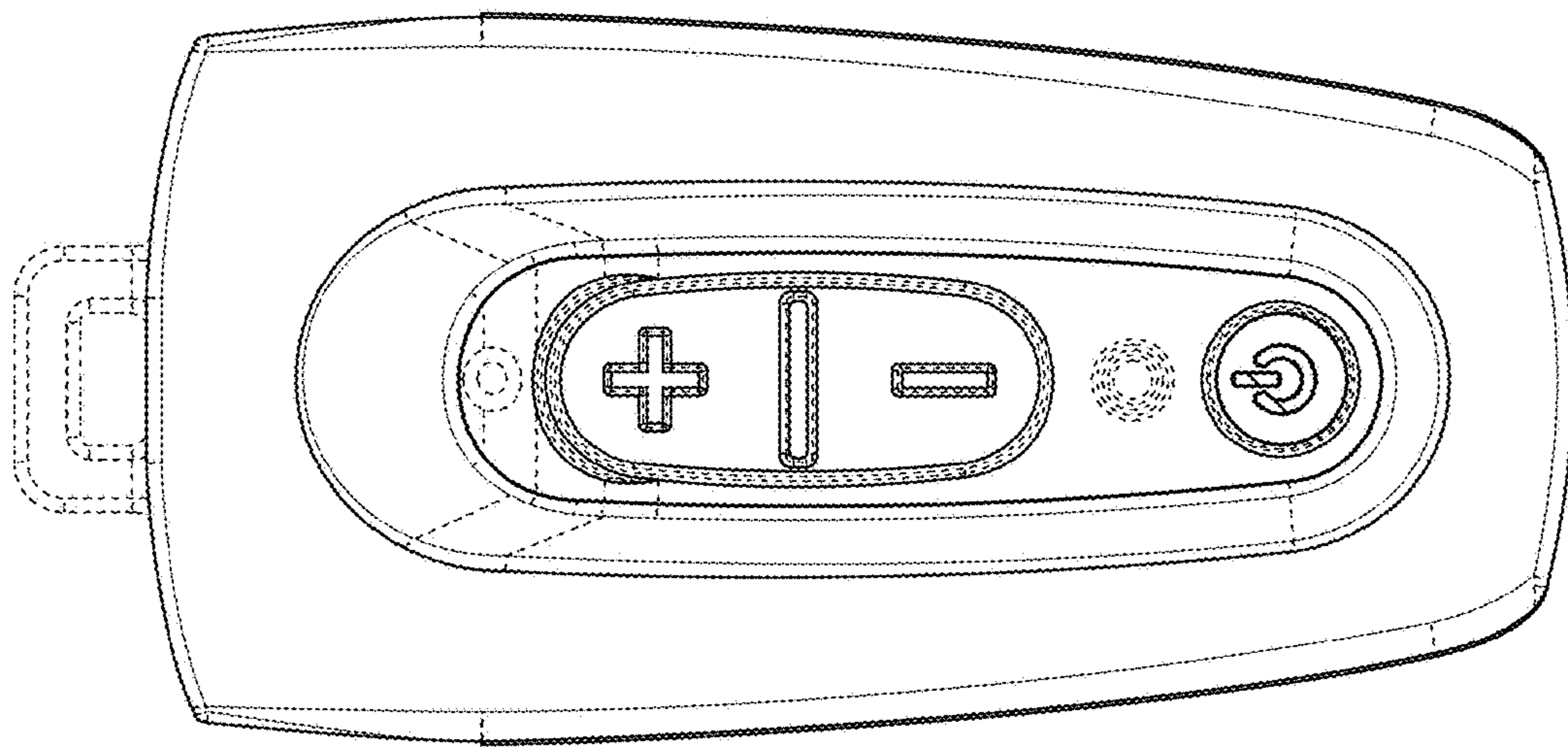

FIG. 2

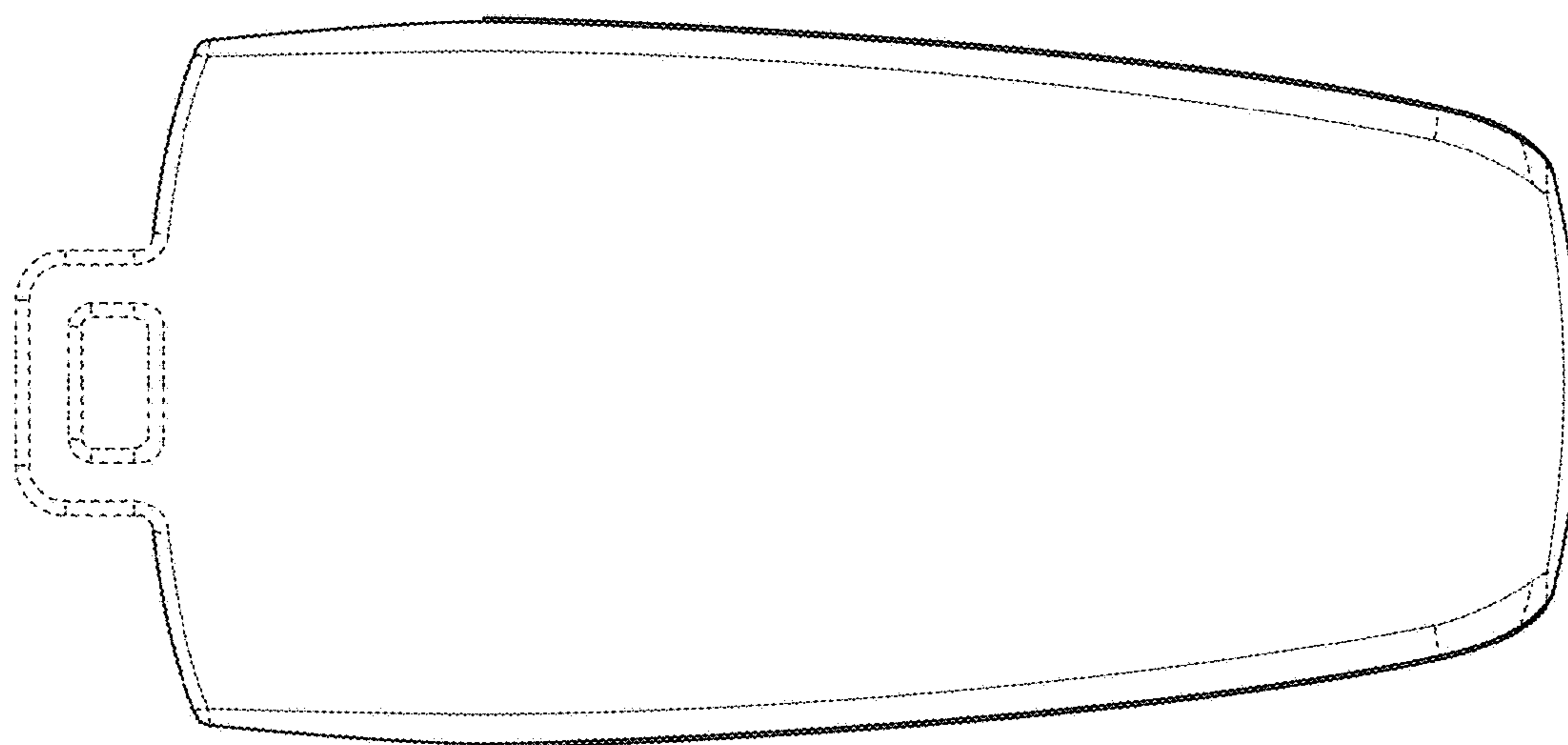

FIG. 3

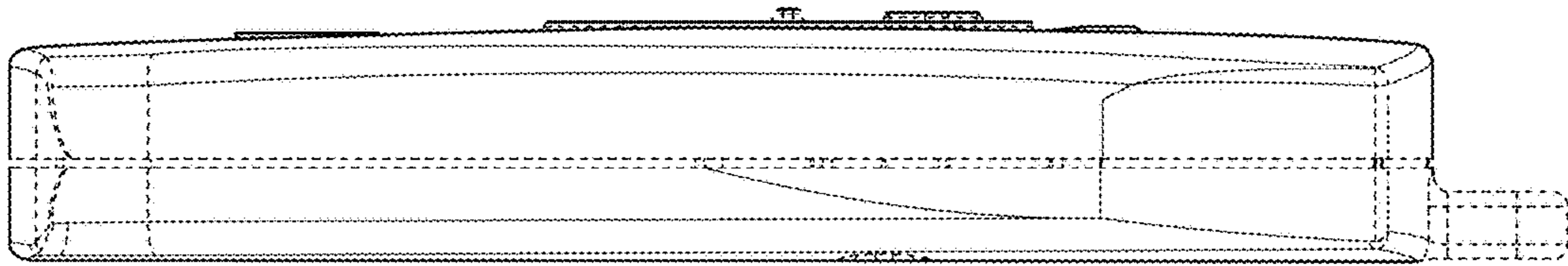

FIG. 4

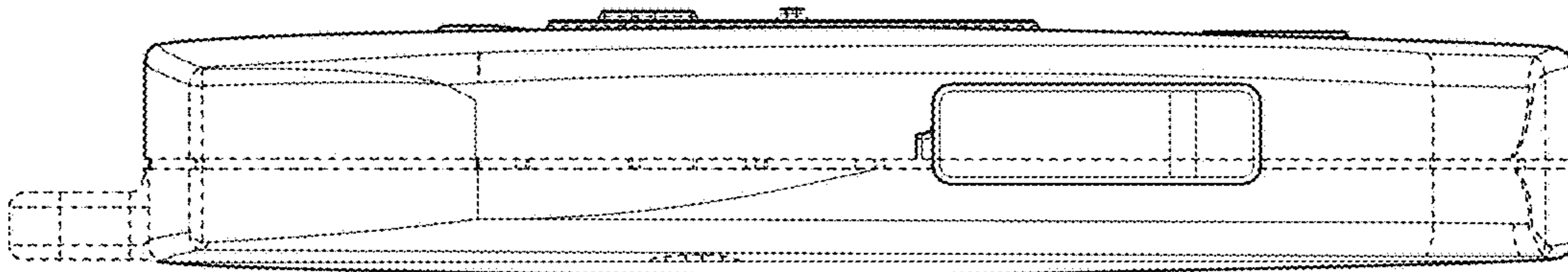
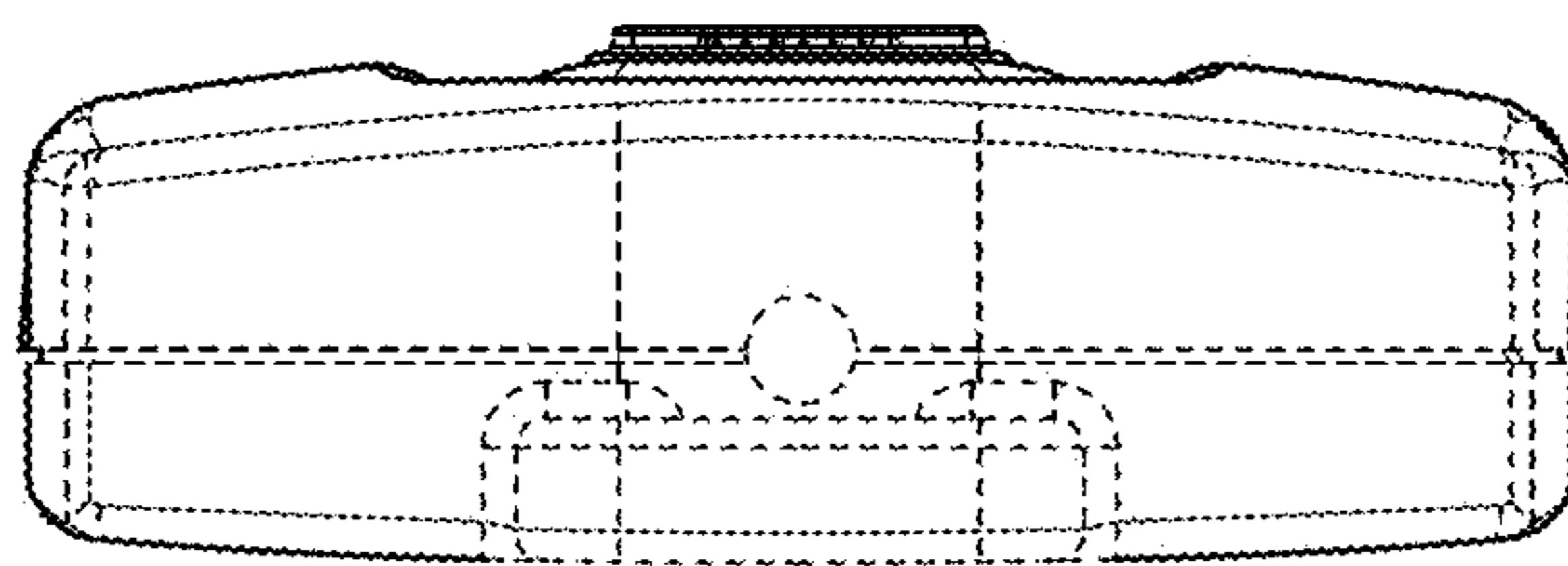

FIG. 5



**FIG. 6**



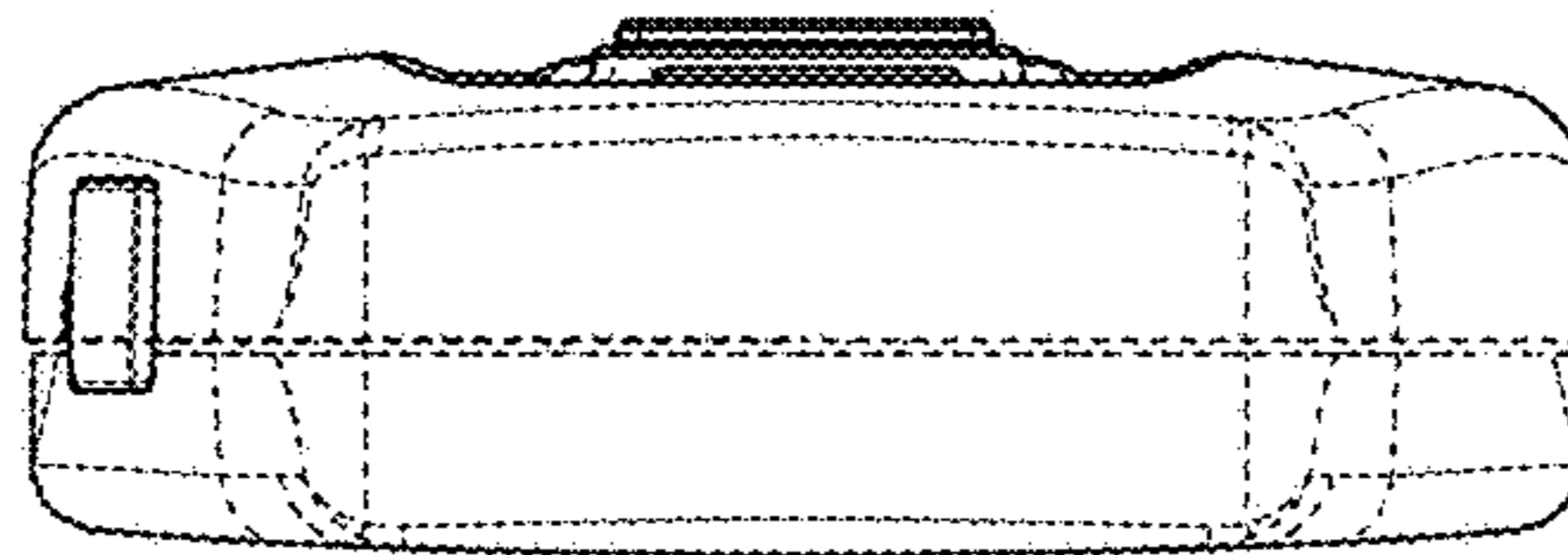

FIG. 7