



US00D788633S

(12) **United States Design Patent**
Rosenberg-Pineau

(10) **Patent No.:** **US D788,633 S**
(45) **Date of Patent:** **** Jun. 6, 2017**

(54) **JEWELRY SETTING**

25/005; A44C 25/007; A44C 25/008;
A44C 3/008

(71) Applicant: **Leo Schachter Diamonds, L.L.C.**,
New York, NY (US)

See application file for complete search history.

(72) Inventor: **Katherine Rosenberg-Pineau**,
Wellesley, MA (US)

(56) **References Cited**

(73) Assignee: **LEO SCHACHTER DIAMONDS,**
L.L.C., New York, NY (US)

U.S. PATENT DOCUMENTS

D260,862 S 9/1981 Linzer
D420,936 S 2/2000 Murray
6,298,689 B1* 10/2001 Lai A44C 17/005
63/26

(Continued)

(**) Term: **15 Years**

OTHER PUBLICATIONS

(21) Appl. No.: **29/559,649**

Notice of Allowance for U.S. Appl. No. 29/527,361, mailed Jan. 29, 2016.

(22) Filed: **Mar. 30, 2016**

Primary Examiner — Cynthia Ramirez

Assistant Examiner — Llorellys Martinez-Rivera

(74) *Attorney, Agent, or Firm* — Pearl Cohen Zedek
Latzer Baratz LLP

Related U.S. Application Data

(62) Division of application No. 29/527,361, filed on May
18, 2015, now Pat. No. Des. 754,022.

(51) **LOC (10) Cl.** **11-01**

(52) **U.S. Cl.**

USPC **D11/91**

(58) **Field of Classification Search**

USPC D11/1-3, 7, 16, 26-45, 47, 63, 67,
D11/75-86, 89-92; D99/25

CPC A44C 1/00; A44C 17/00; A44C 17/001;
A44C 17/02; A44C 17/0208; A44C
17/0216; A44C 17/0225; A44C 17/0233;
A44C 17/0241; A44C 17/025; A44C
17/0258; A44C 17/0266; A44C 17/0275;
A44C 17/0283; A44C 17/0291; A44C
17/04; A44C 17/043; A44C 17/046; A44C
15/002; A44C 15/0025; A44C 23/00;
A44C 25/00; A44C 25/001; A44C

(57) **CLAIM**

The ornamental design for a jewelry setting, as shown and
described.

DESCRIPTION

FIG. 1 is a top, front, right side perspective view of a first
embodiment of a jewelry setting showing my new design;
FIG. 2 is a front elevation view thereof;
FIG. 3 is a rear elevation view thereof;
FIG. 4 is a right side elevation view thereof;
FIG. 5 is a left side elevation view thereof;
FIG. 6 is a top plan view thereof;
FIG. 7 is a bottom plan view thereof;
FIG. 8 is a top, front, right side perspective view of a second
embodiment of a jewelry setting showing my new design;
FIG. 9 is a front elevation view thereof;
FIG. 10 is a back elevation view thereof;
FIG. 11 is a right side elevation view thereof;
FIG. 12 is a left side elevation view thereof;
FIG. 13 is a top plan view thereof; and,

(Continued)

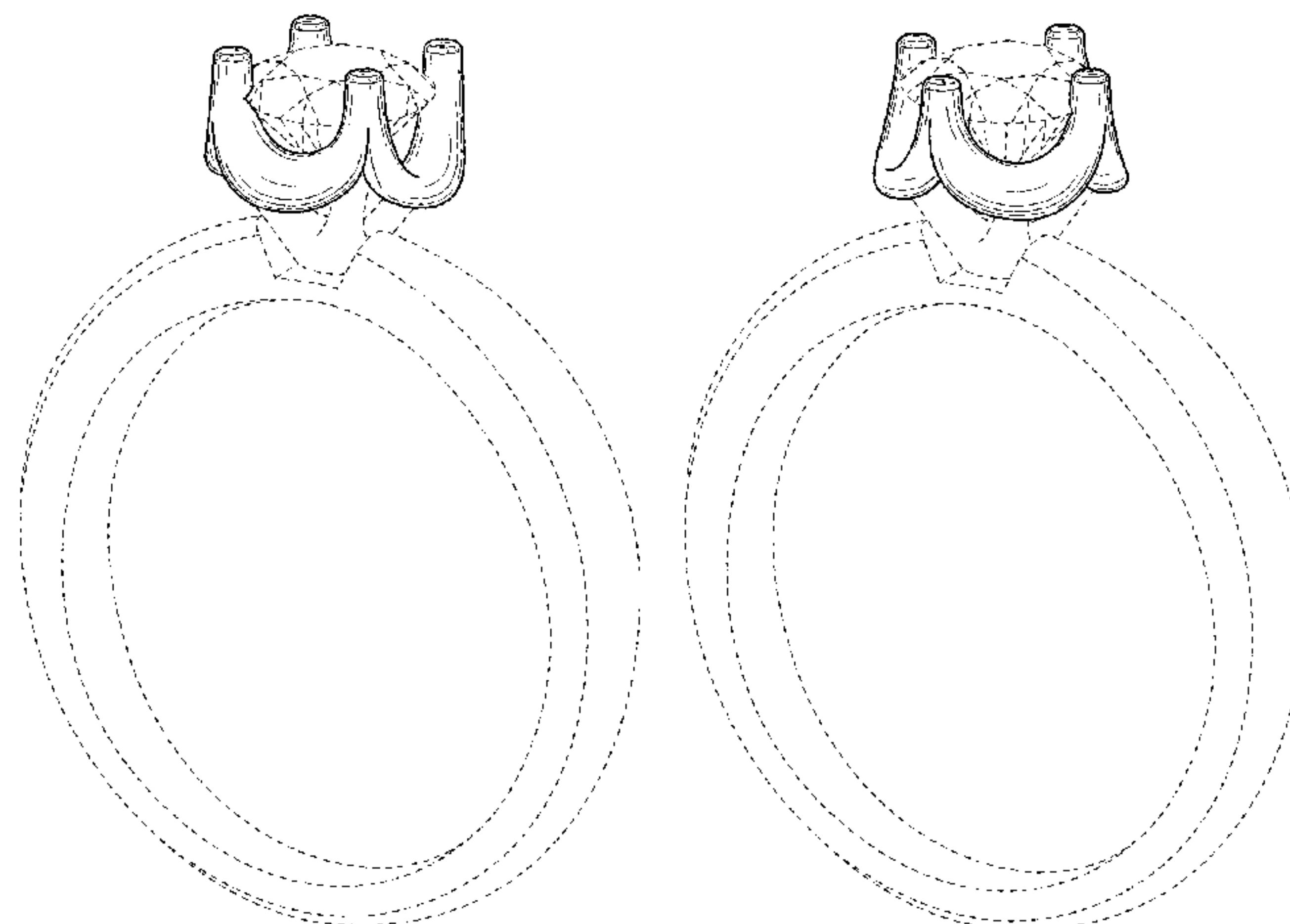

FIG. 14 is a bottom plan view thereof.
The broken lines shown in FIGS. 1-14 illustrate environmental subject matter only and form no part of the claimed design.

1 Claim, 6 Drawing Sheets

(56)

References Cited

U.S. PATENT DOCUMENTS

D506,158 S *	6/2005	McMullan	D11/91
D508,866 S *	8/2005	Shin	D11/34
D513,712 S *	1/2006	Koren	D11/34
D546,235 S	7/2007	Sabet		
D547,688 S *	7/2007	Sabet	D11/34
D570,243 S *	6/2008	Giles	D11/92
D574,289 S	8/2008	Karavani		
D580,294 S	11/2008	Sabet		
D602,807 S	10/2009	Colombani		

D610,034 S	2/2010	Colombani		
D628,113 S	11/2010	Papadimitriou		
D636,694 S *	4/2011	Papadimitriou	D11/34
D637,101 S *	5/2011	Papadimitriou	D11/34
D637,102 S	5/2011	Papadimitriou		
D639,692 S	6/2011	Papadimitriou		
D639,693 S	6/2011	Papadimitriou		
D672,680 S *	12/2012	Papadimitriou	D11/34
D676,348 S *	2/2013	Papadimitriou	D11/34
D676,779 S	2/2013	Papadimitriou		
D677,192 S	3/2013	Papadimitriou		
D677,597 S *	3/2013	Papadimitriou	D11/34
D686,102 S *	7/2013	Shlakman	D11/26
D726,068 S	4/2015	Minister		
D727,202 S	4/2015	Shlakman		
D729,106 S	5/2015	Shlakman		
D754,022 S *	4/2016	Rosenberg-Pineau	D11/91
D754,023 S *	4/2016	Dholakiya	D11/92
D755,073 S *	5/2016	Rosenberg-Pineau	D11/91
D763,115 S *	8/2016	Nisguretsky	D11/34
D780,058 S *	2/2017	Shlakman	D11/34
2007/0256452 A1	11/2007	Aghjayan		
2014/0345322 A1	11/2014	Logian		

* cited by examiner

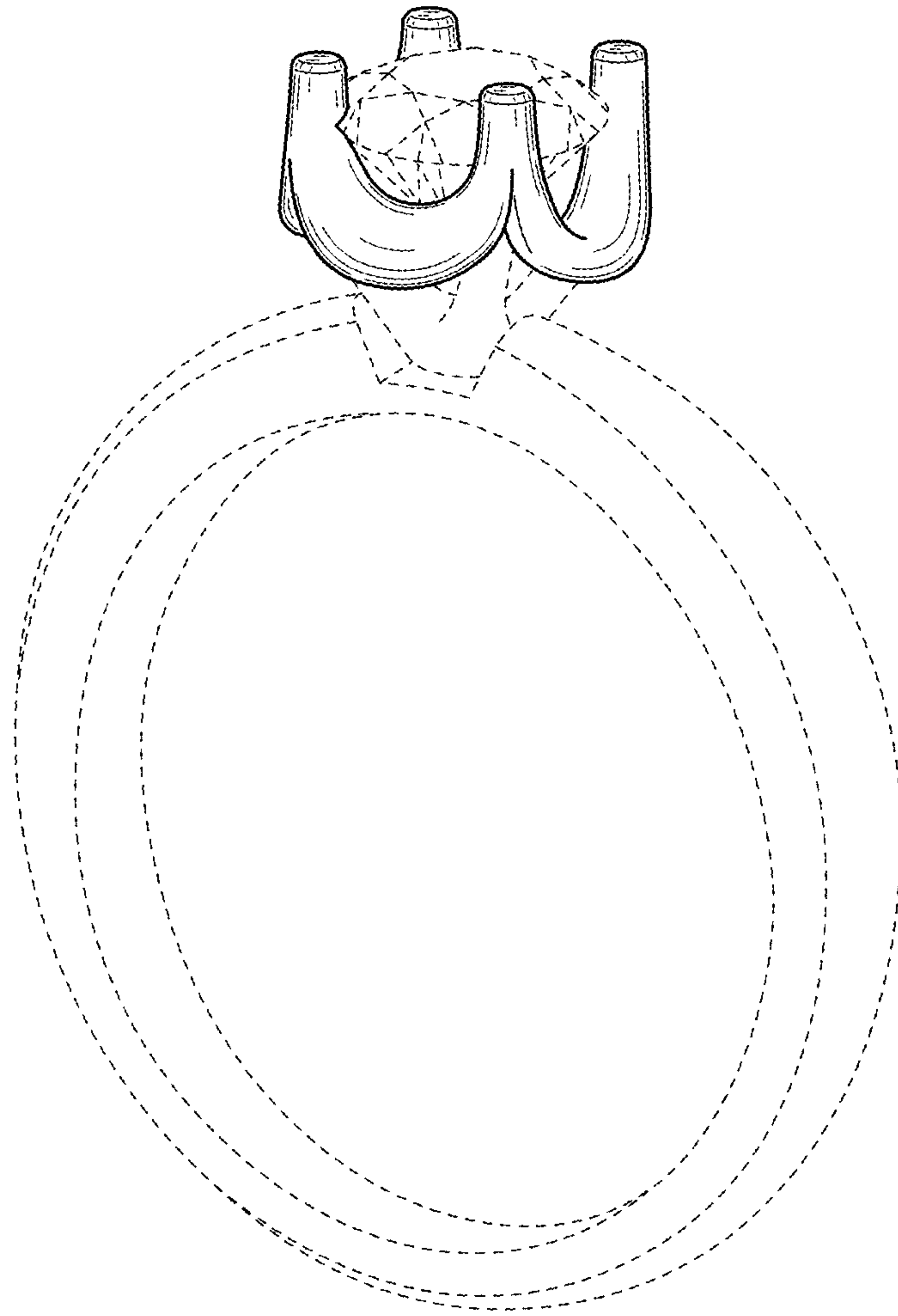

FIG. 1

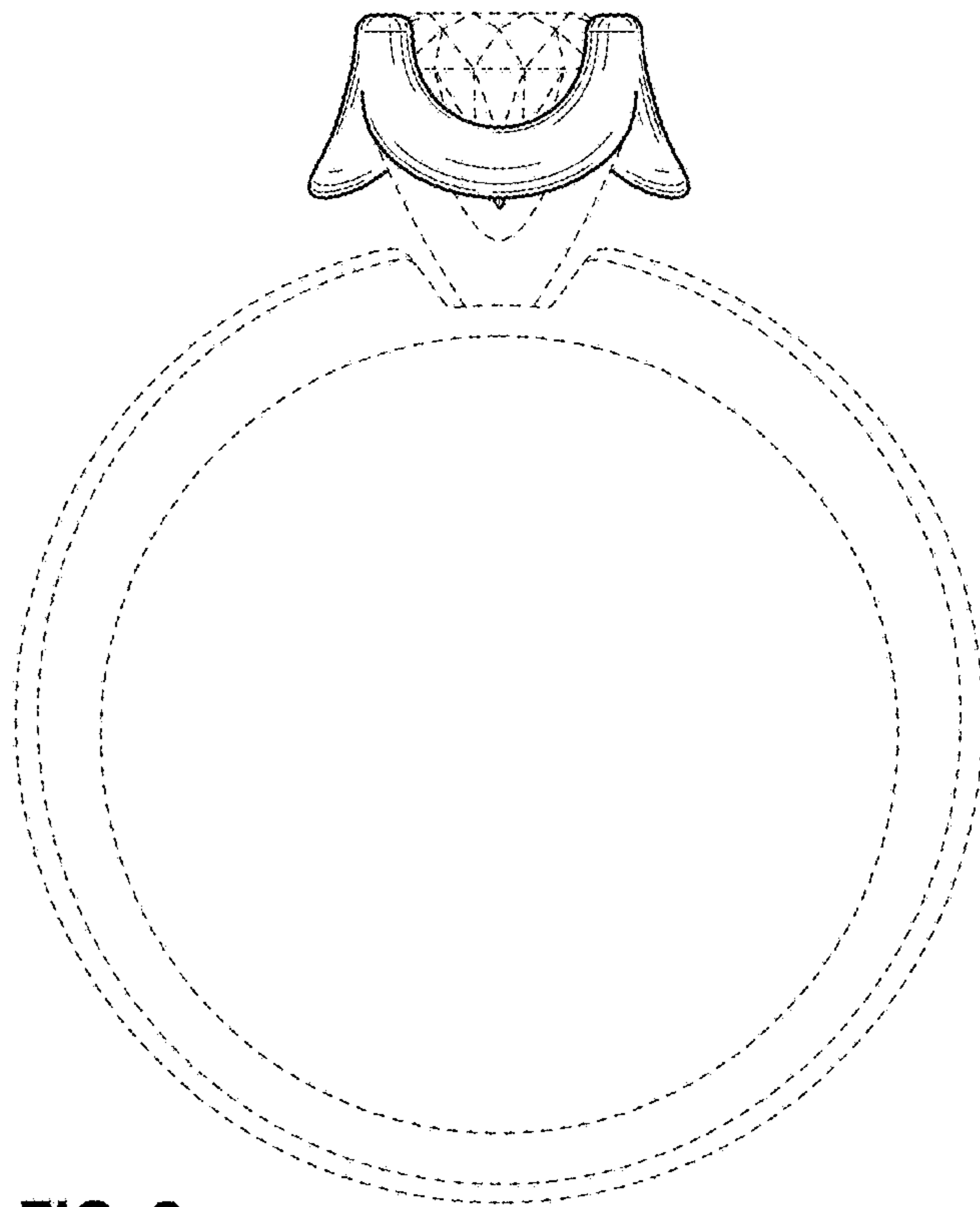

FIG. 2

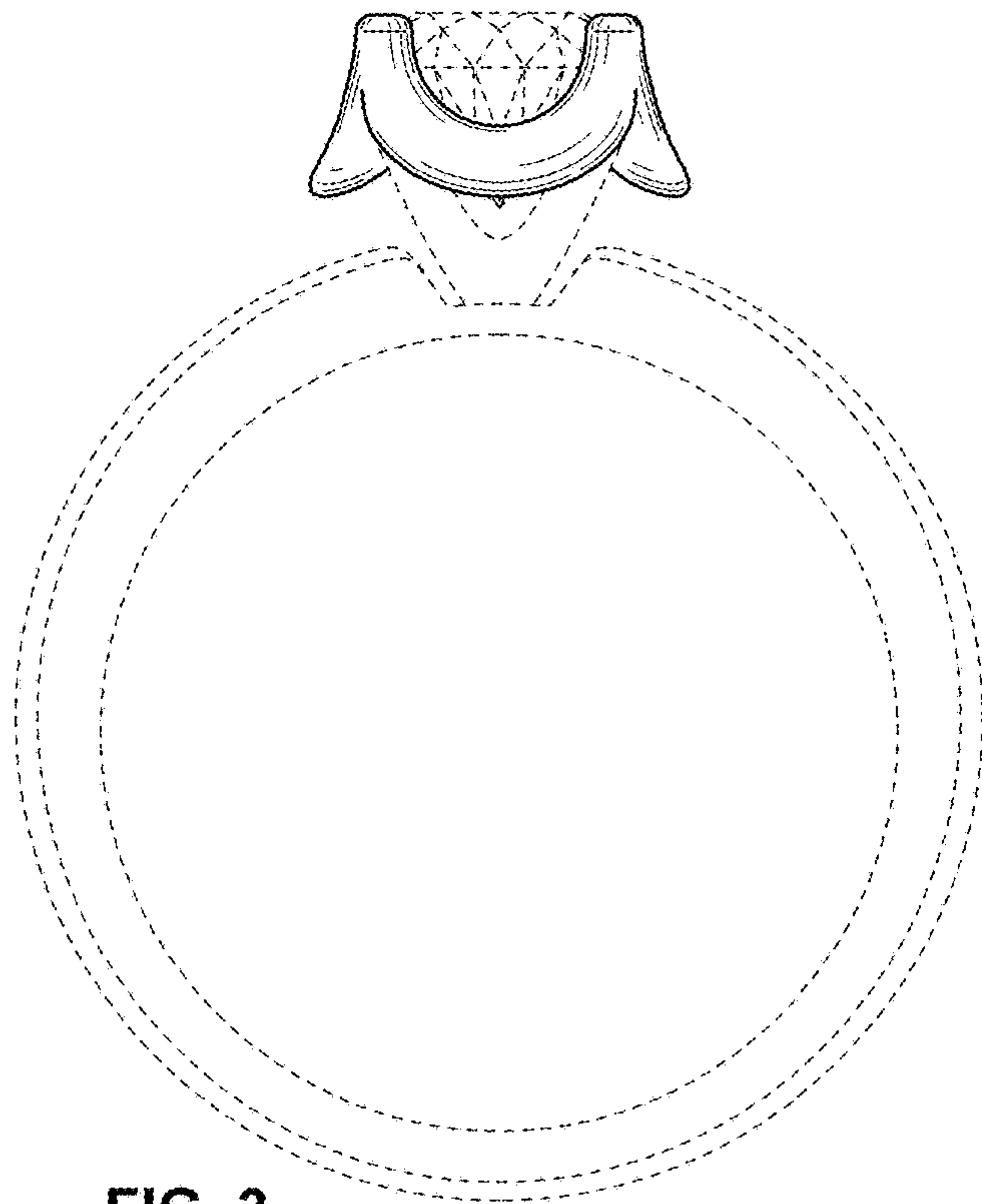

FIG. 3

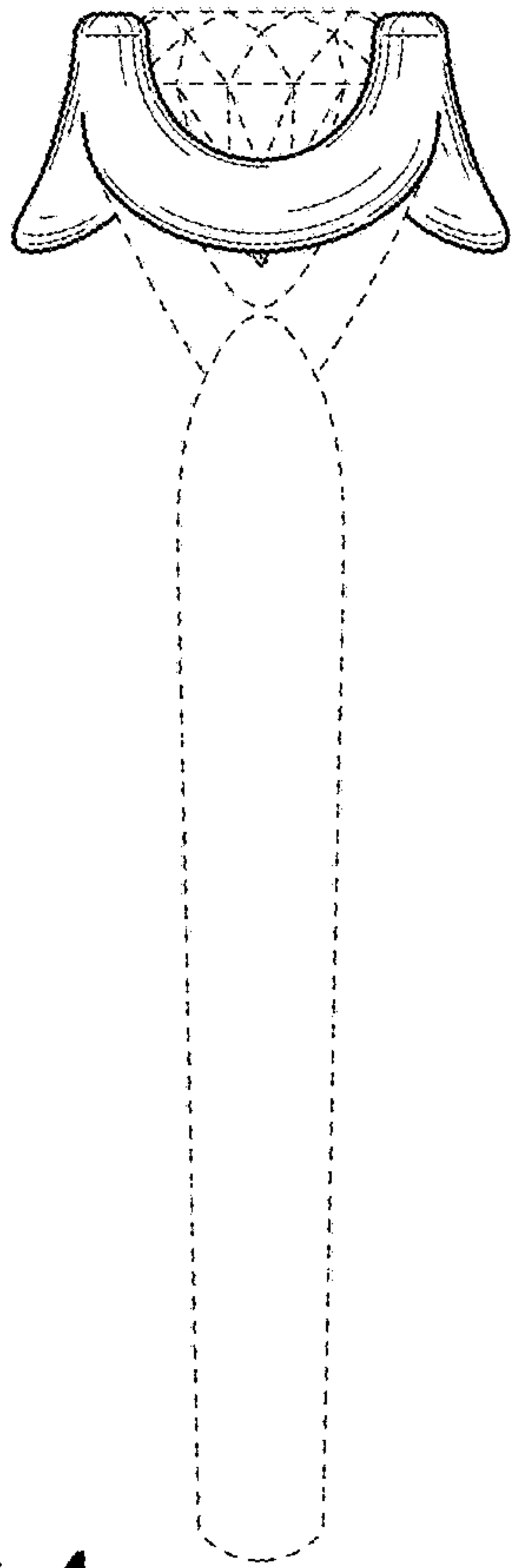

FIG. 4

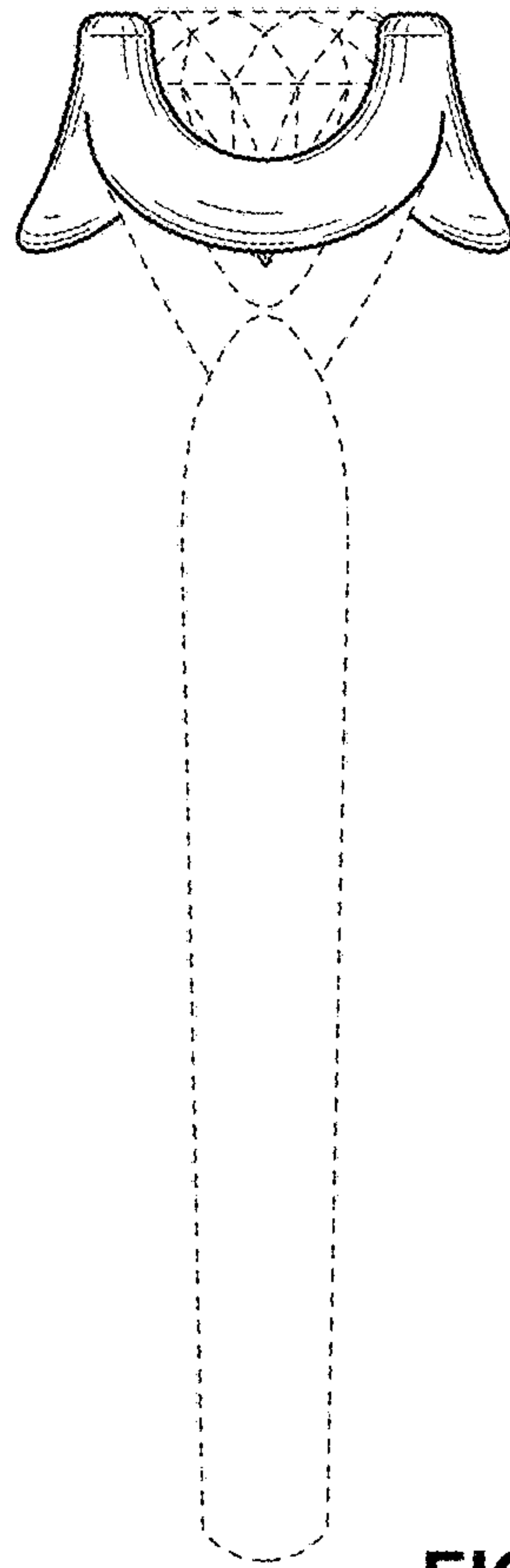

FIG. 5

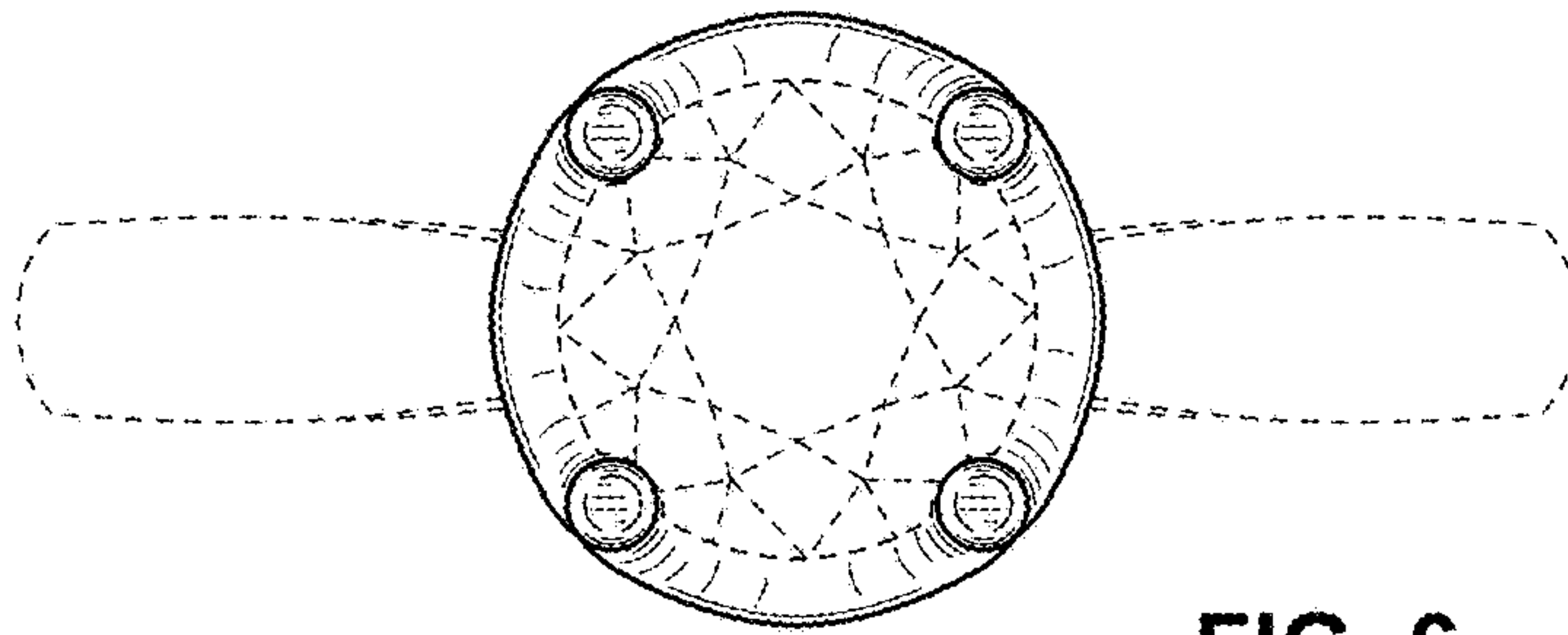

FIG. 6

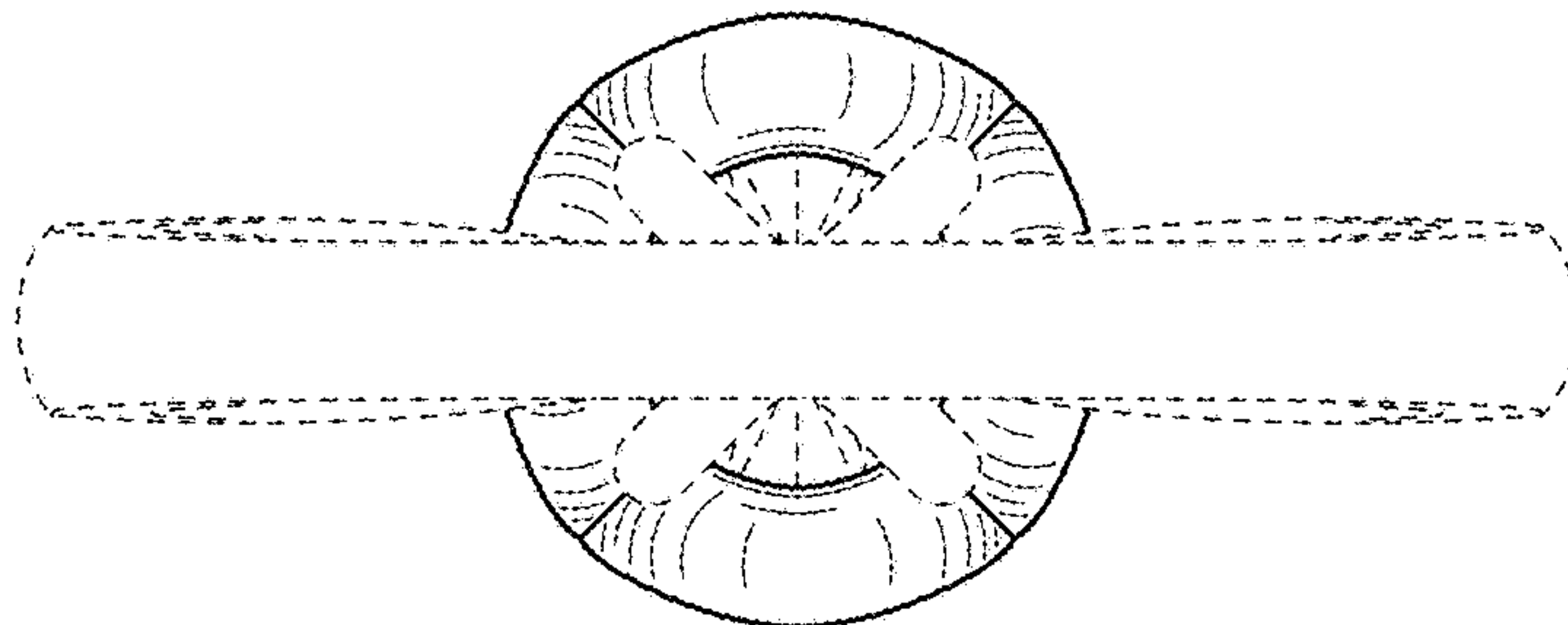

FIG. 7

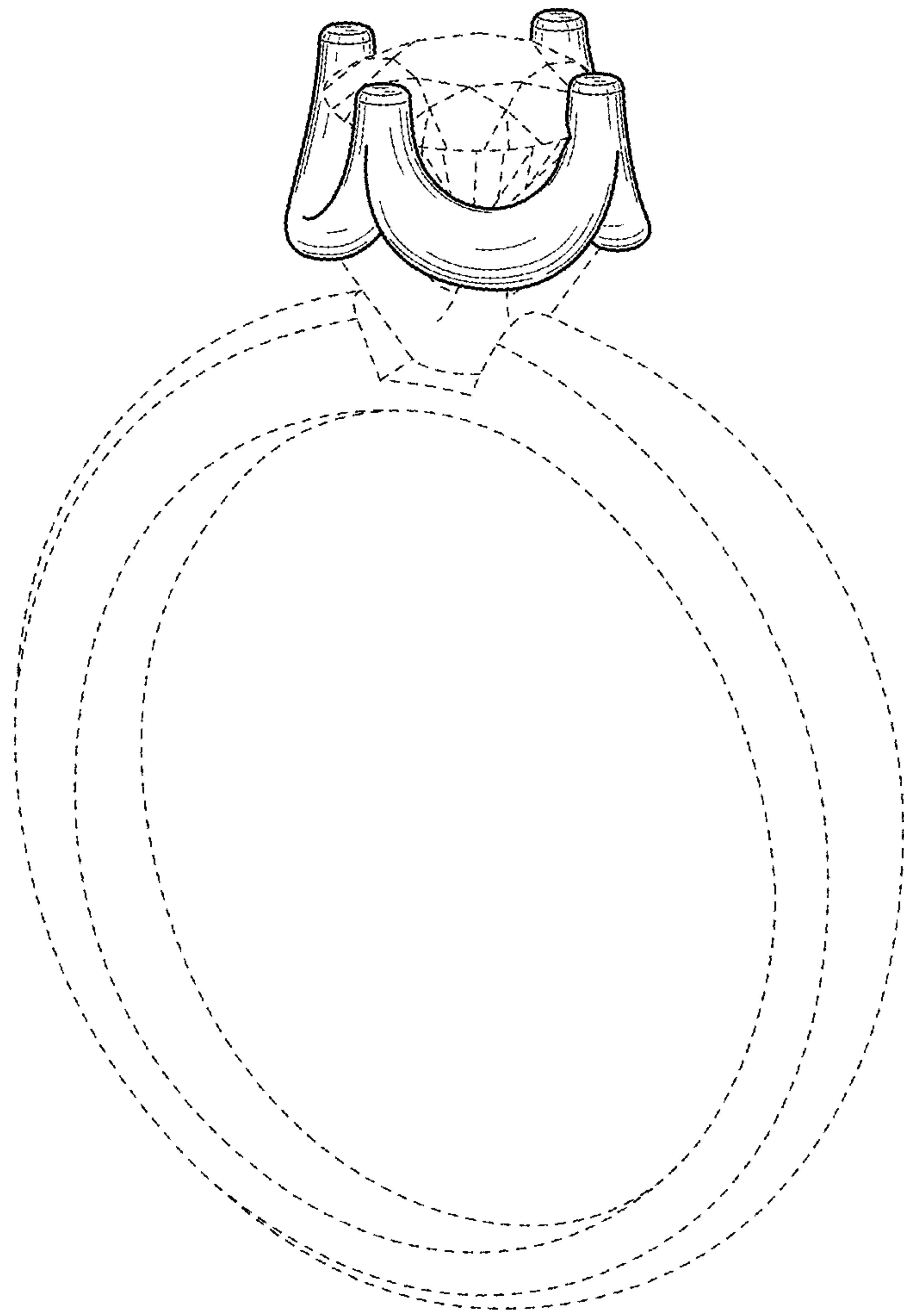

FIG. 8

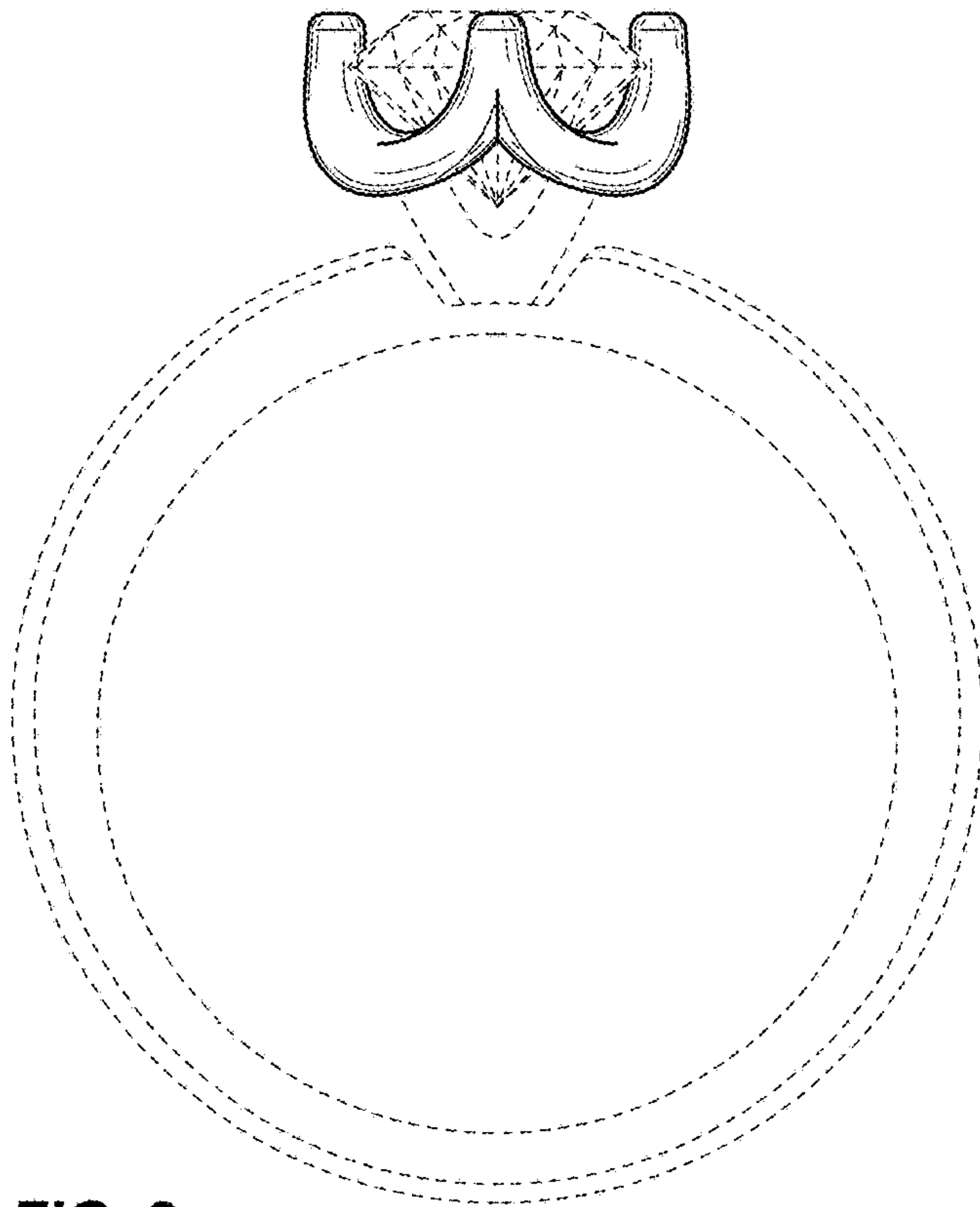

FIG. 9

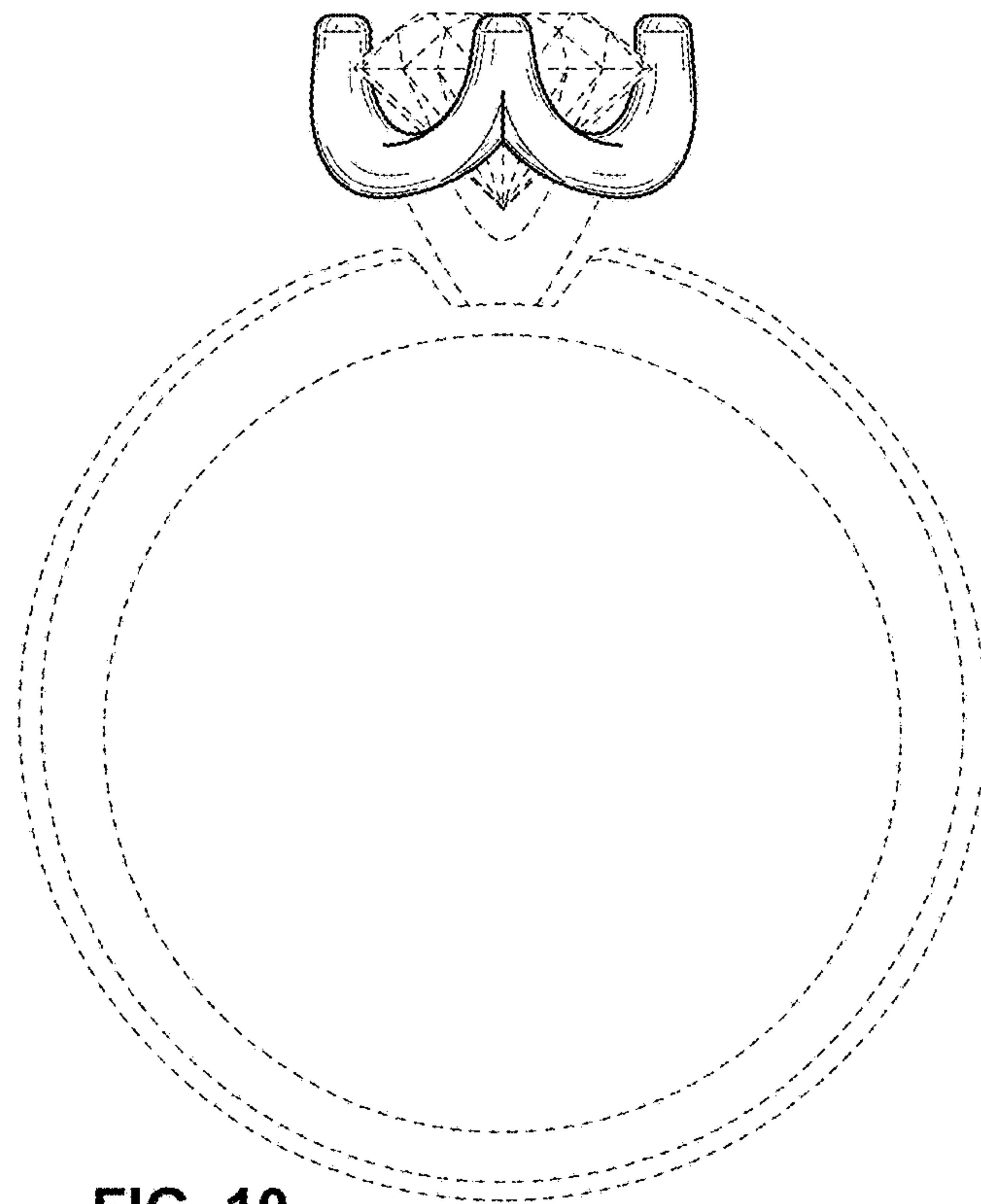

FIG. 10

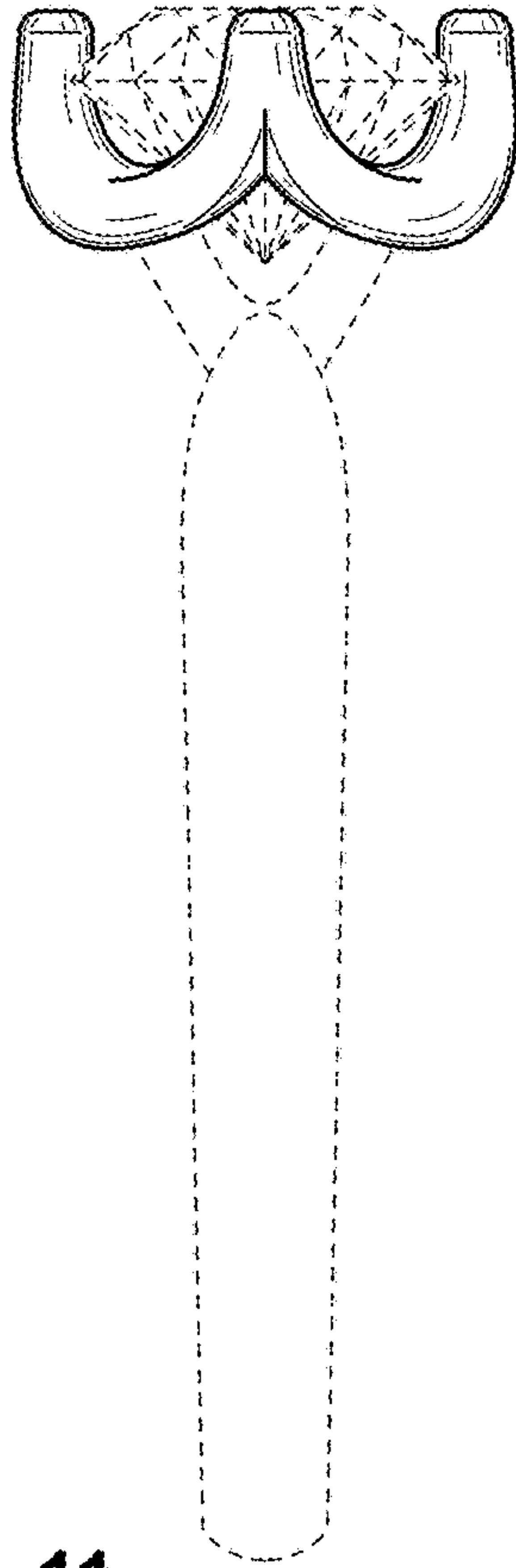

FIG. 11

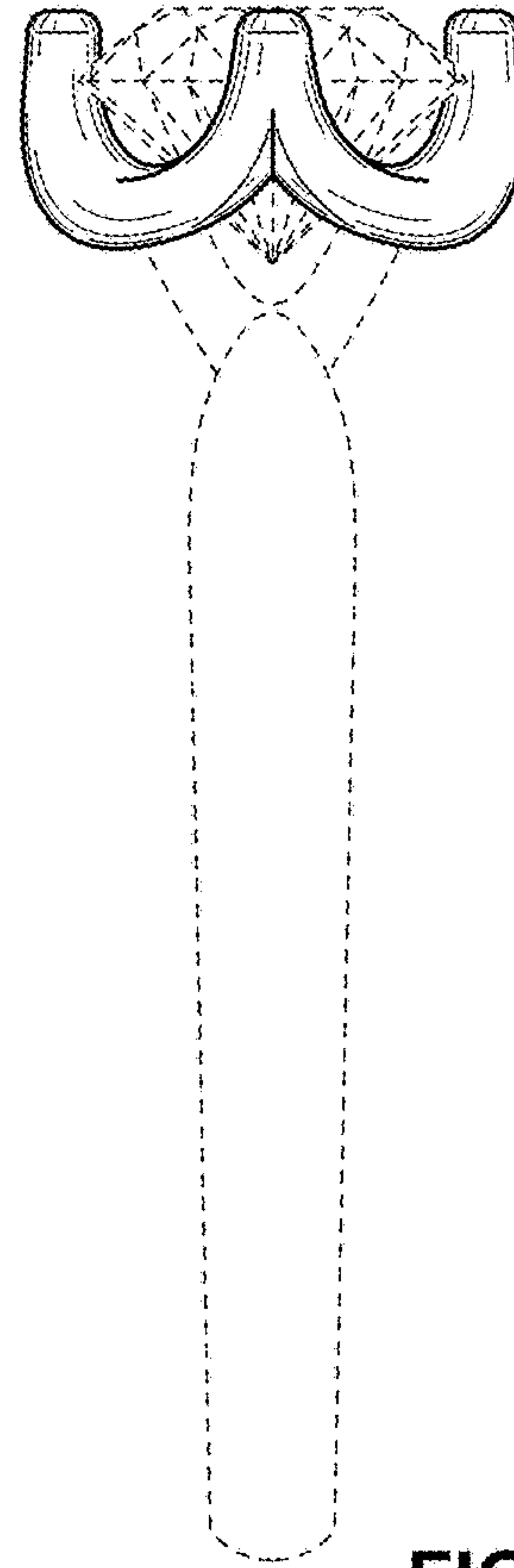

FIG. 12

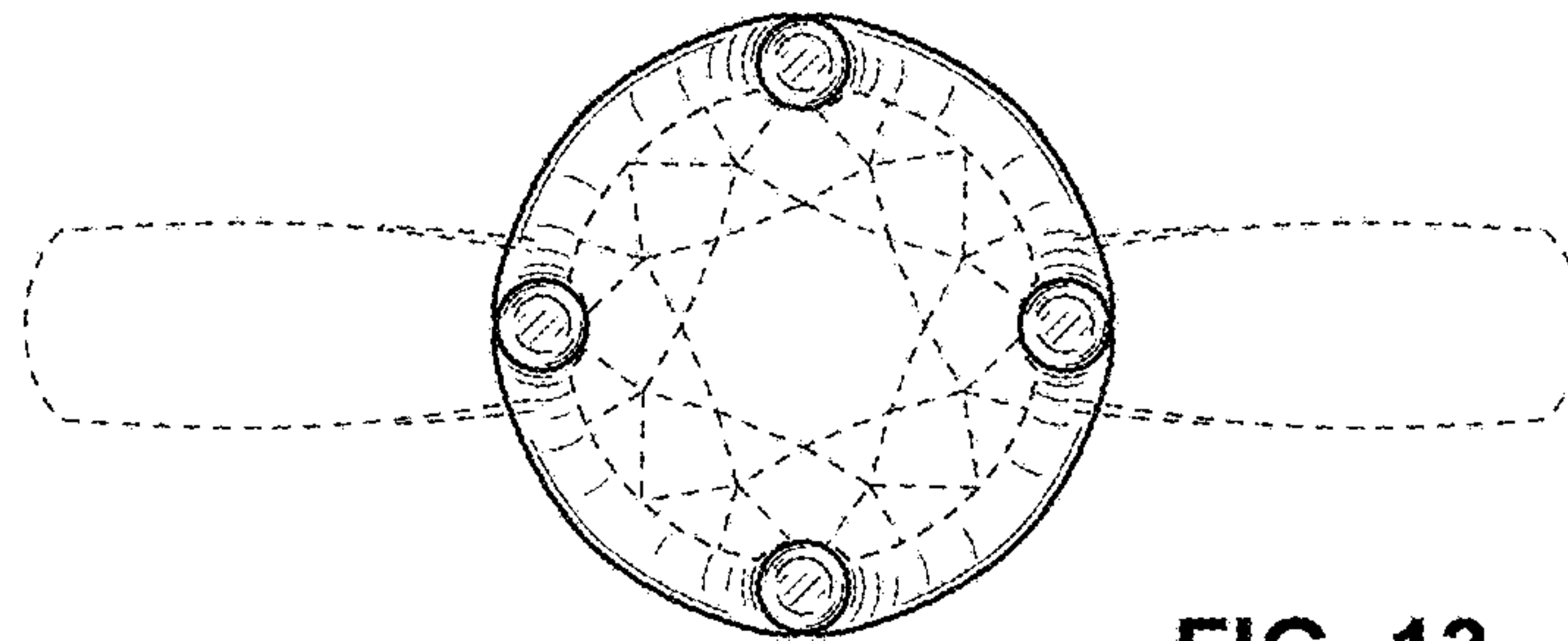

FIG. 13

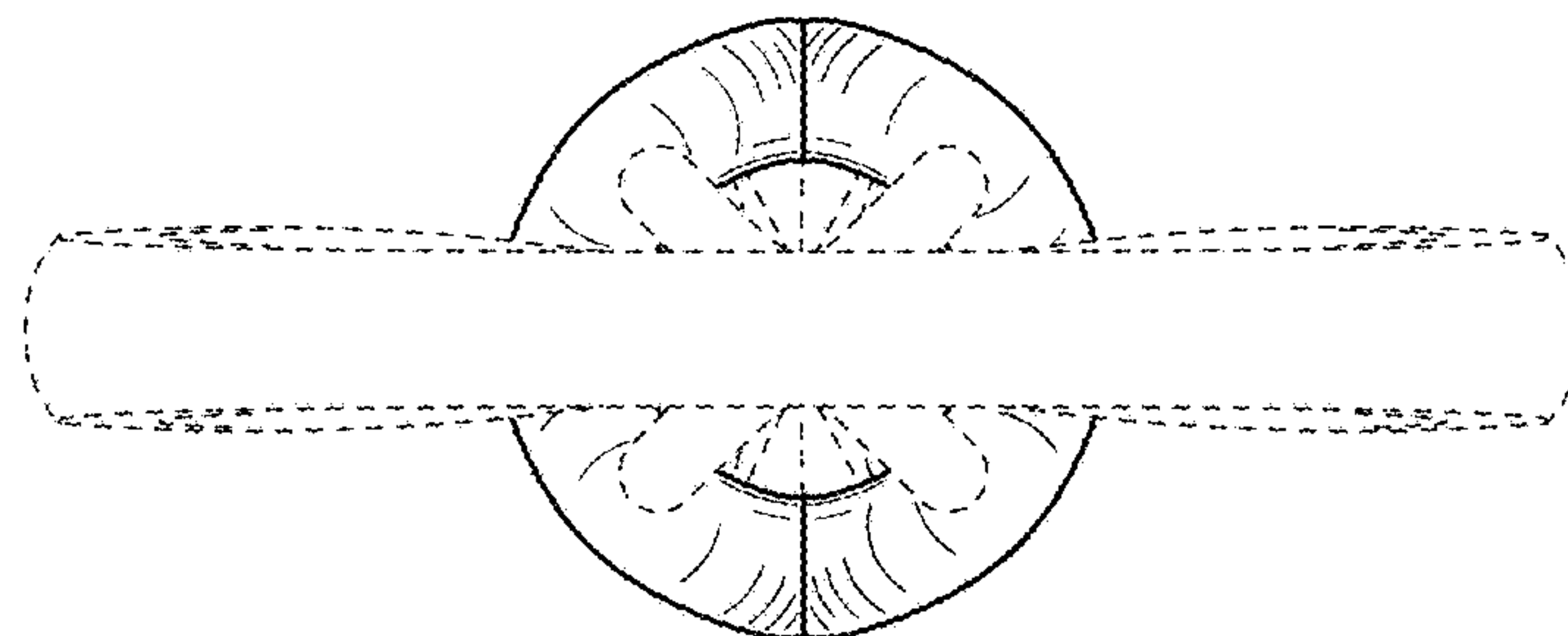

FIG. 14