



US00D788514S

(12) **United States Design Patent**  
**Bock**

(10) **Patent No.:** **US D788,514 S**

(45) **Date of Patent:** **\*\* Jun. 6, 2017**

(54) **OVEN**

(71) Applicant: **Hamilton Beach Brands, Inc.**, Glen Allen, VA (US)

(72) Inventor: **Brian Bock**, Midlothian, VA (US)

(73) Assignee: **Hamilton Beach Brands, Inc.**, Glen Allen, VA (US)

(\*\*) Term: **15 Years**

(21) Appl. No.: **29/532,068**

(22) Filed: **Jul. 1, 2015**

(51) **LOC (10) Cl.** ..... **07-02**

(52) **U.S. Cl.**  
USPC ..... **D7/350.1; D7/329**

(58) **Field of Classification Search**  
USPC ... D7/323, 338, 339, 346-349, 350.1-350.4,  
D7/351, 393-395, 402, 405, 406,  
D7/328-330; 219/678; D8/303, 308  
CPC .... H05B 6/763; H05B 6/6414; H05B 6/6408;  
Y02B 40/14; Y02B 40/143; Y02B  
40/146; F24C 15/02; F24C 1/00; F24C  
14/00; F24C 3/00; F24C 5/00; F24C  
7/00; A47J 37/00; A47J 37/06; A47J  
37/0611; A47J 37/08; A47J 37/0807;  
A47J 37/0814; A47J 37/0835; A47J  
37/085; A47J 37/0864; A47J 37/0878;  
A47J 37/0885; A47J 37/0892

See application file for complete search history.

(56) **References Cited**

**U.S. PATENT DOCUMENTS**

D223,066 S \* 3/1972 Hanson et al. .... D7/329  
D237,242 S 10/1975 Claxton

D241,602 S 9/1976 Hanson et al.  
5,694,831 A 12/1997 Haroun et al.  
D393,395 S 4/1998 Tanaka et al.  
D427,838 S 7/2000 Lee  
6,657,168 B1 12/2003 Lazzer  
6,717,110 B2 4/2004 Van der Meer et al.  
7,105,778 B1 9/2006 DeLong et al.  
D549,034 S 8/2007 Garman et al.  
D570,638 S 6/2008 Barnes  
D583,184 S 12/2008 DeLong  
D638,249 S \* 5/2011 Ryan ..... D7/350.1  
D644,309 S \* 8/2011 De'Longhi ..... D7/350.1  
D662,759 S \* 7/2012 Blacken ..... D7/328  
D663,156 S \* 7/2012 Curtis ..... D7/350.1  
D736,554 S \* 8/2015 Steiner ..... D7/350.1  
D749,886 S \* 2/2016 Prats ..... D7/330  
D781,635 S \* 3/2017 Koszylko ..... D7/348

\* cited by examiner

*Primary Examiner* — Keli L Hill

(74) *Attorney, Agent, or Firm* — Alexander D Raring

(57) **CLAIM**

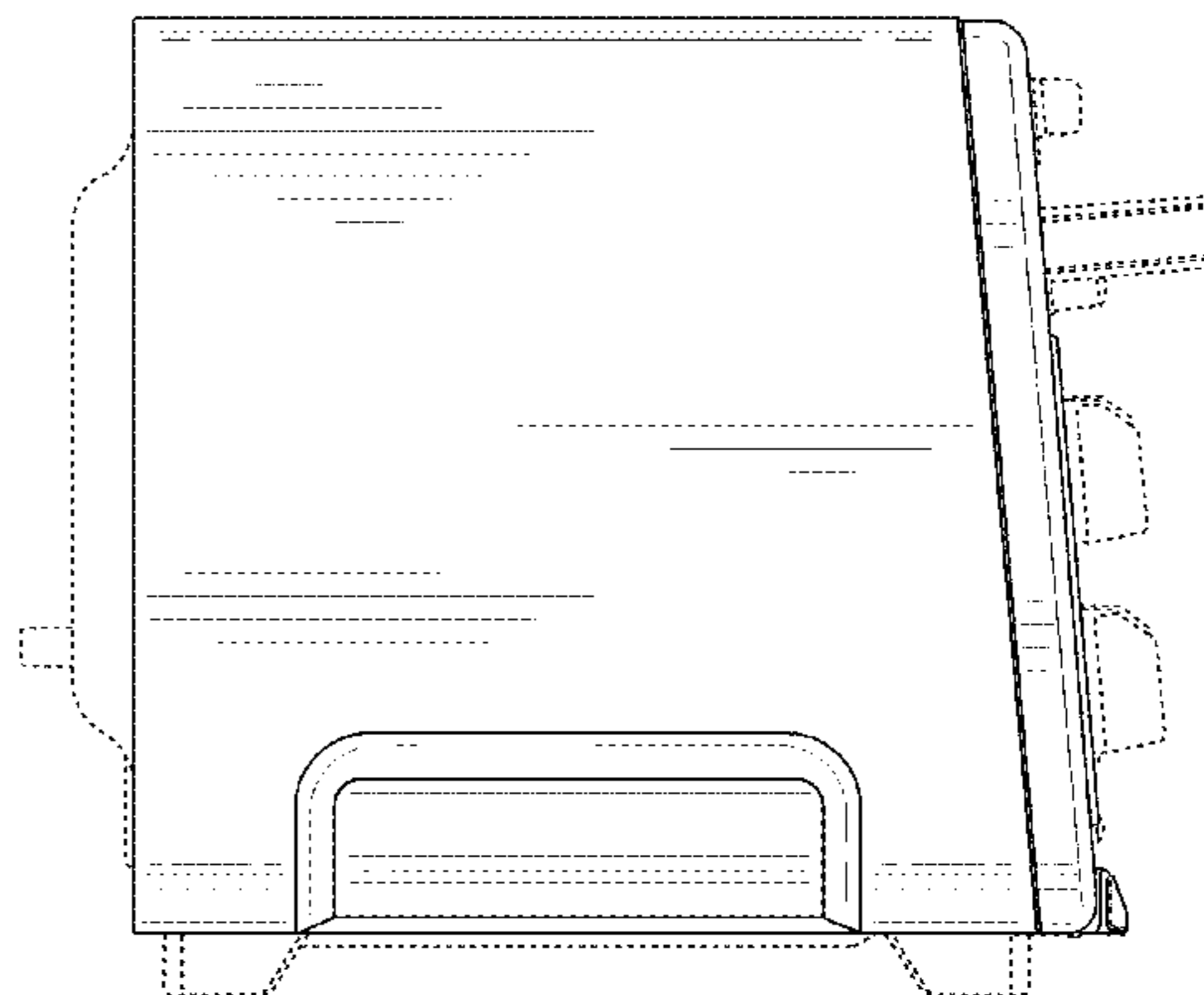
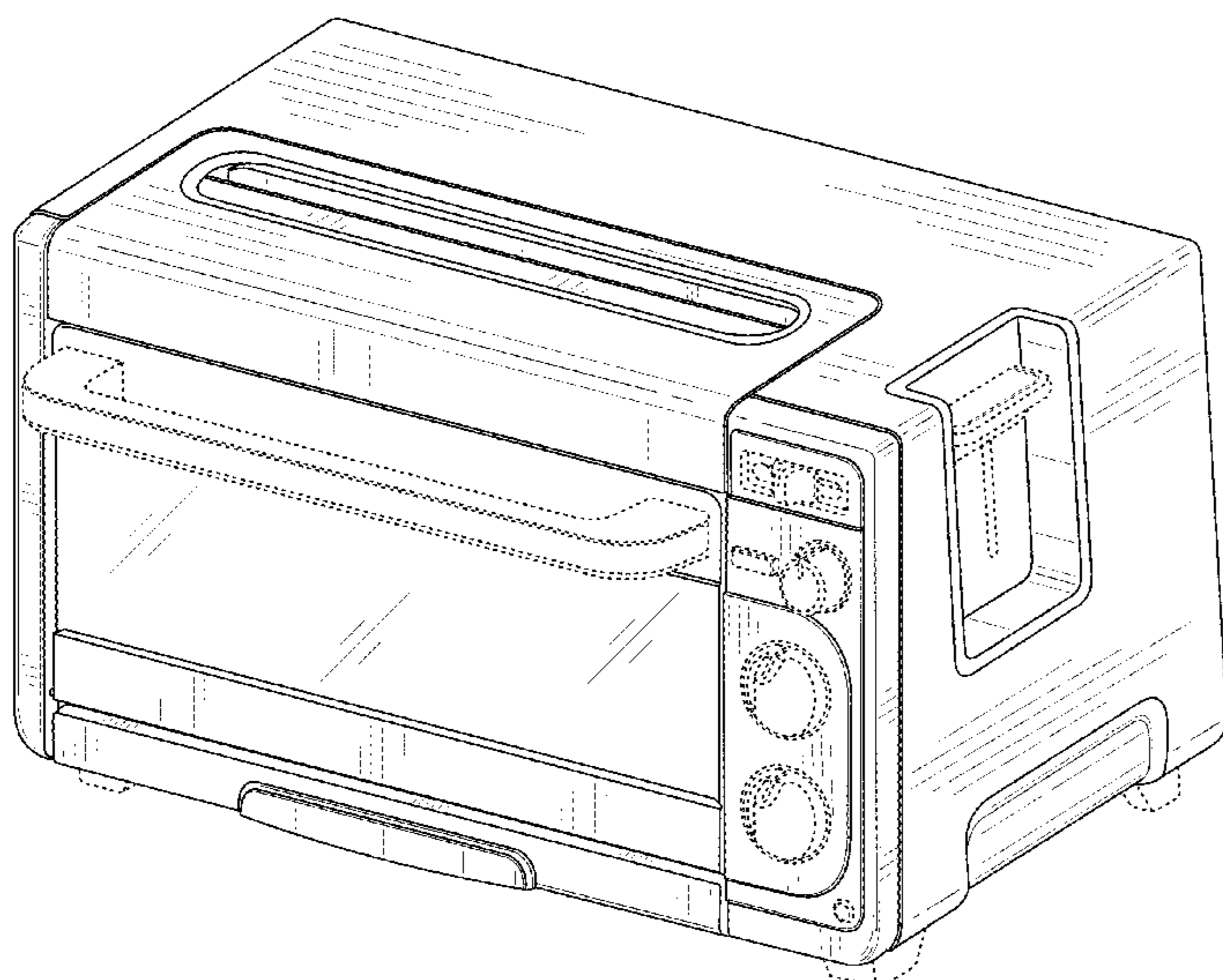
The ornamental design for an oven, as shown and described.

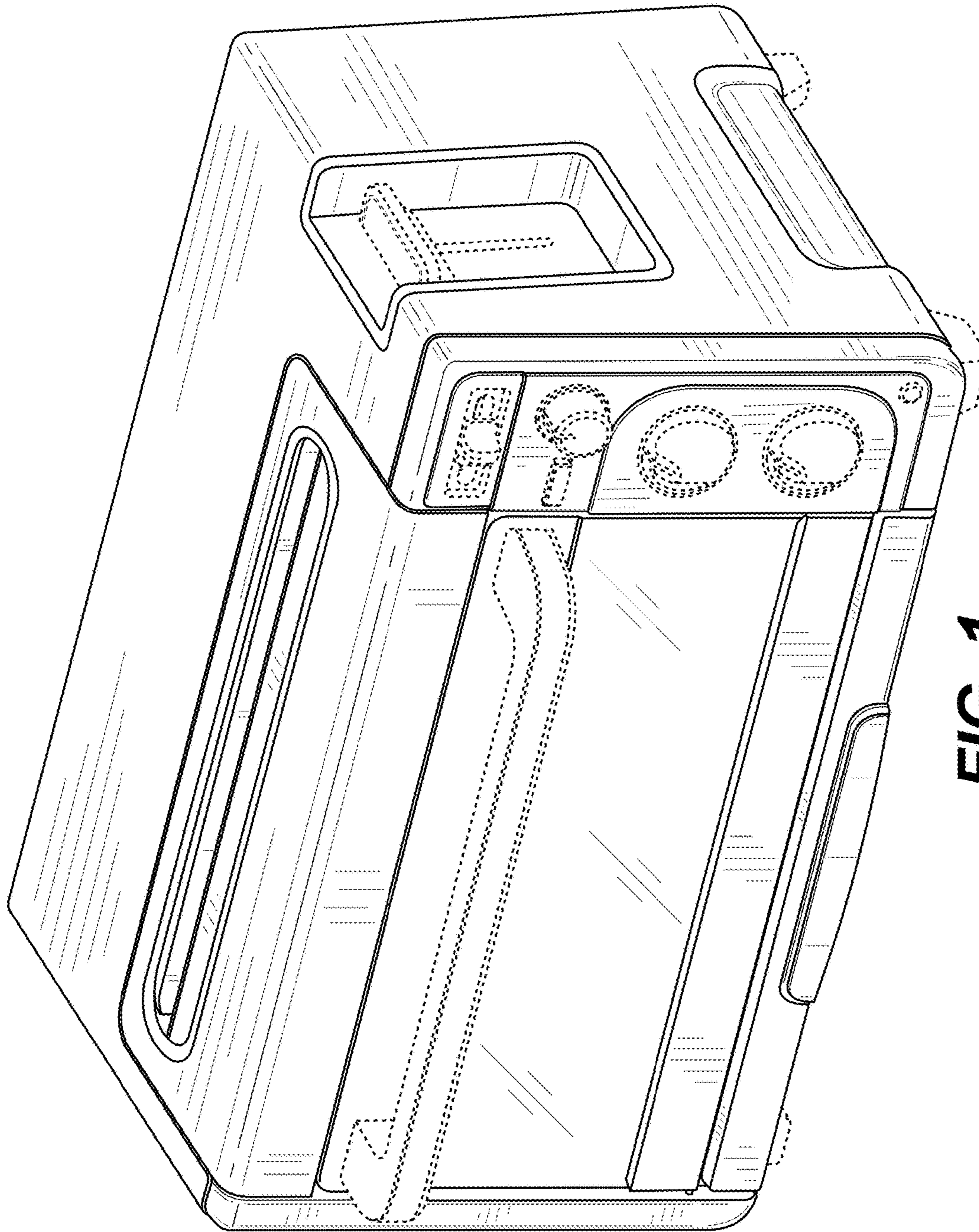
**DESCRIPTION**

FIG. 1 is a perspective view as seen from the top, front and right side of an oven showing the new design;  
FIG. 2 is a front view thereof;  
FIG. 3 is a rear view thereof;  
FIG. 4 is a left side view thereof;  
FIG. 5 is a right side view thereof;  
FIG. 6 is a top view thereof; and,  
FIG. 7 is a bottom view thereof.

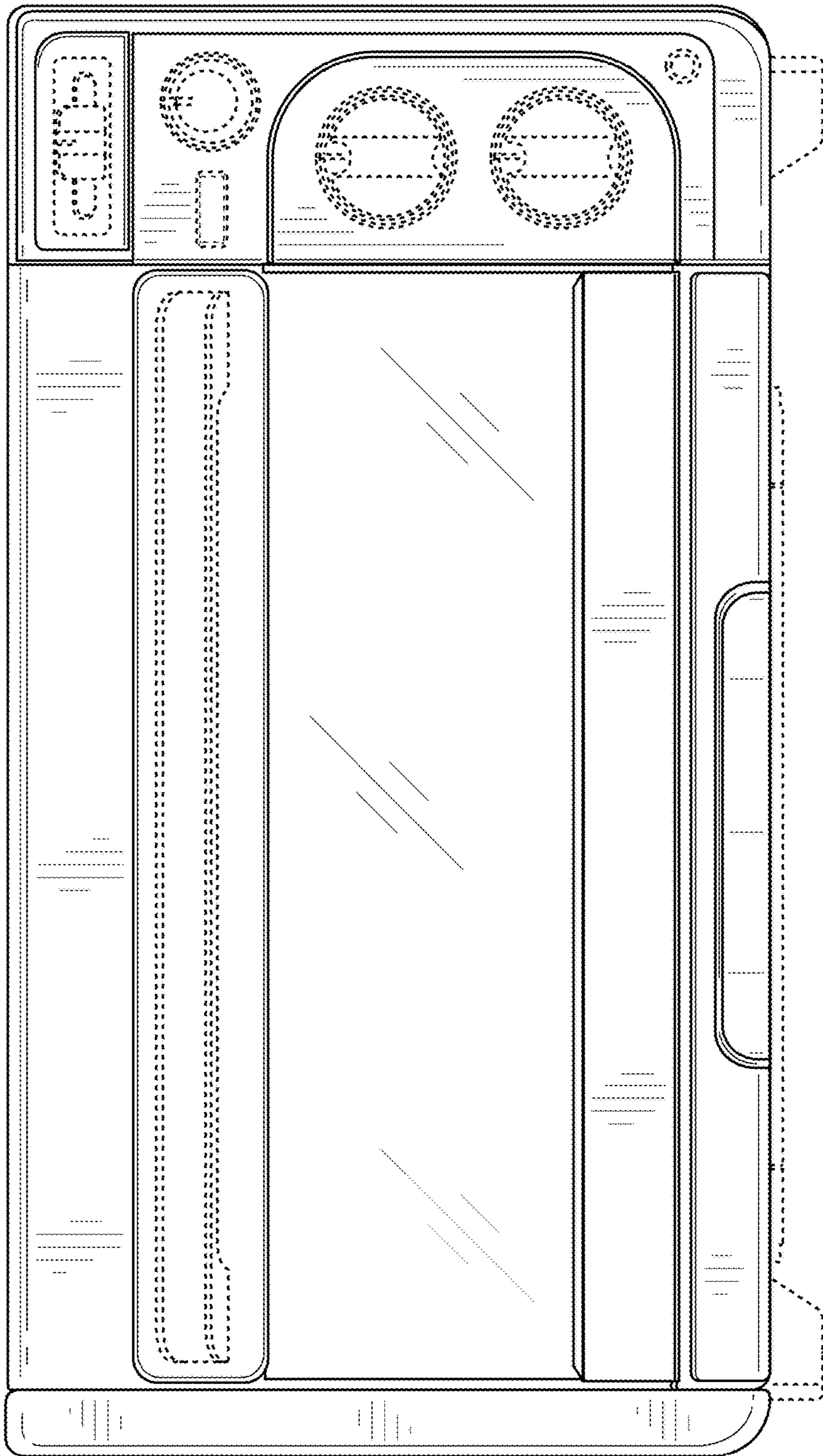
The broken lines shown are included for the purpose of illustrating portions of the oven that form no part of the claim.

**1 Claim, 7 Drawing Sheets**

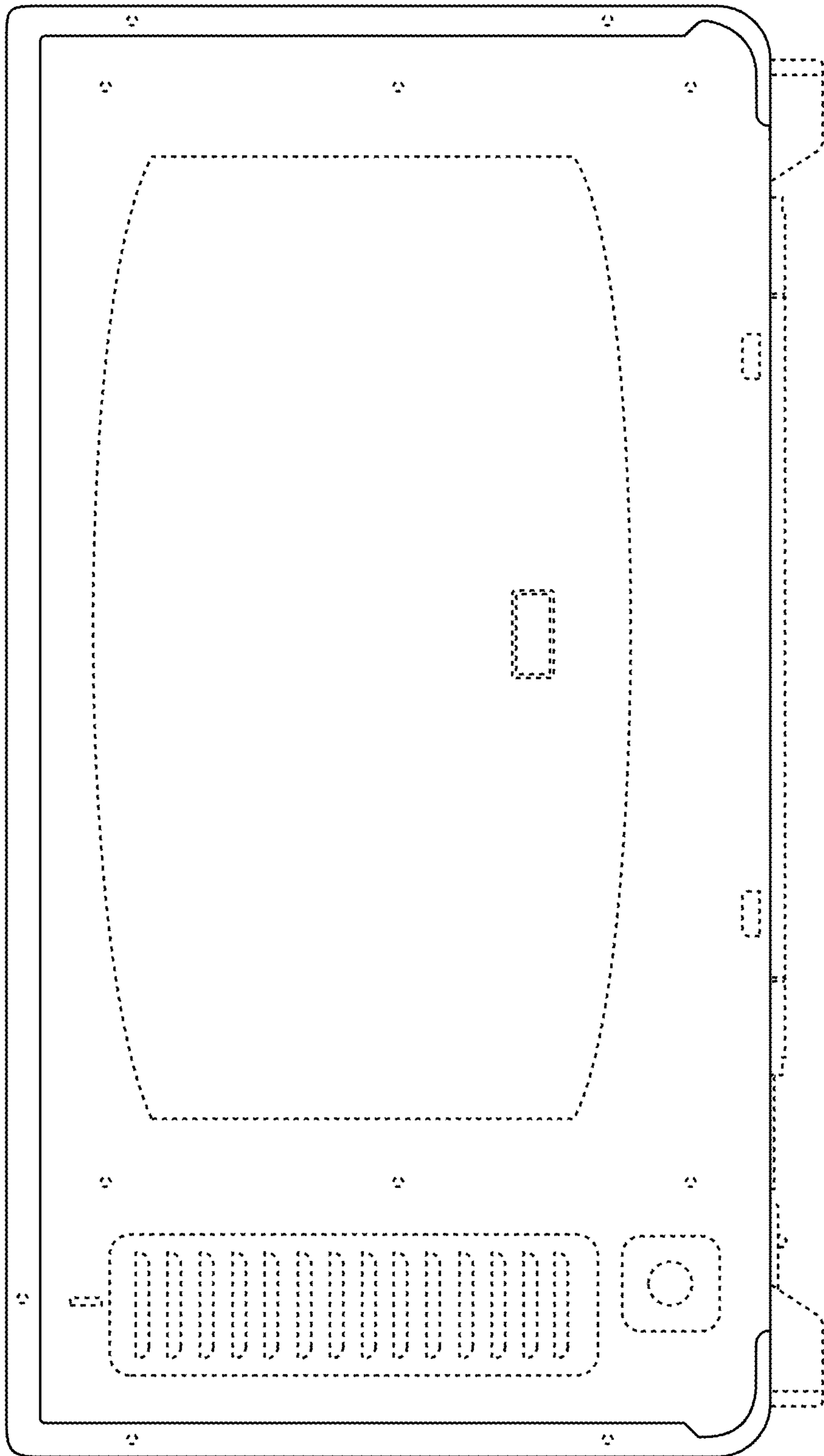




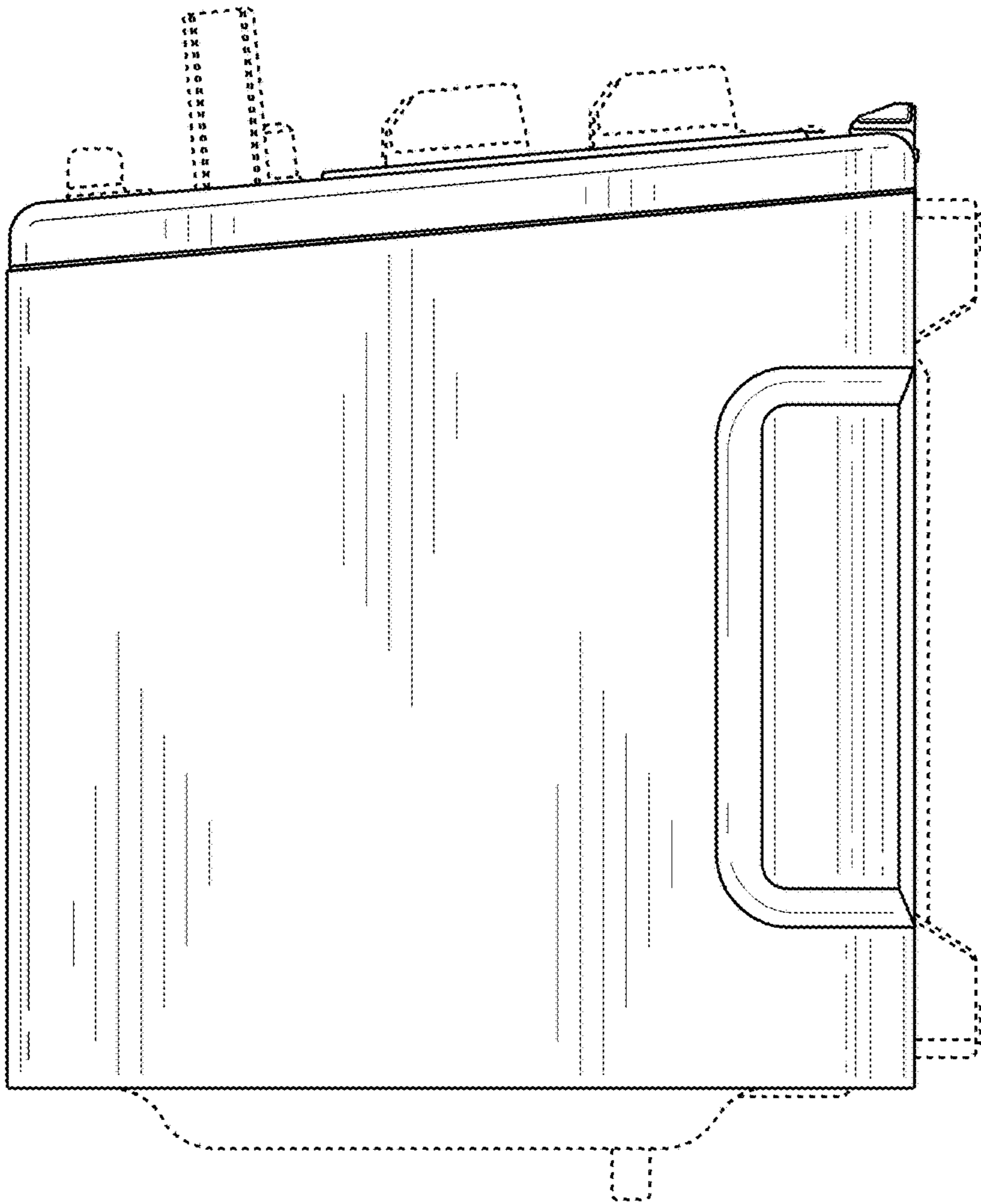
**FIG. 1**



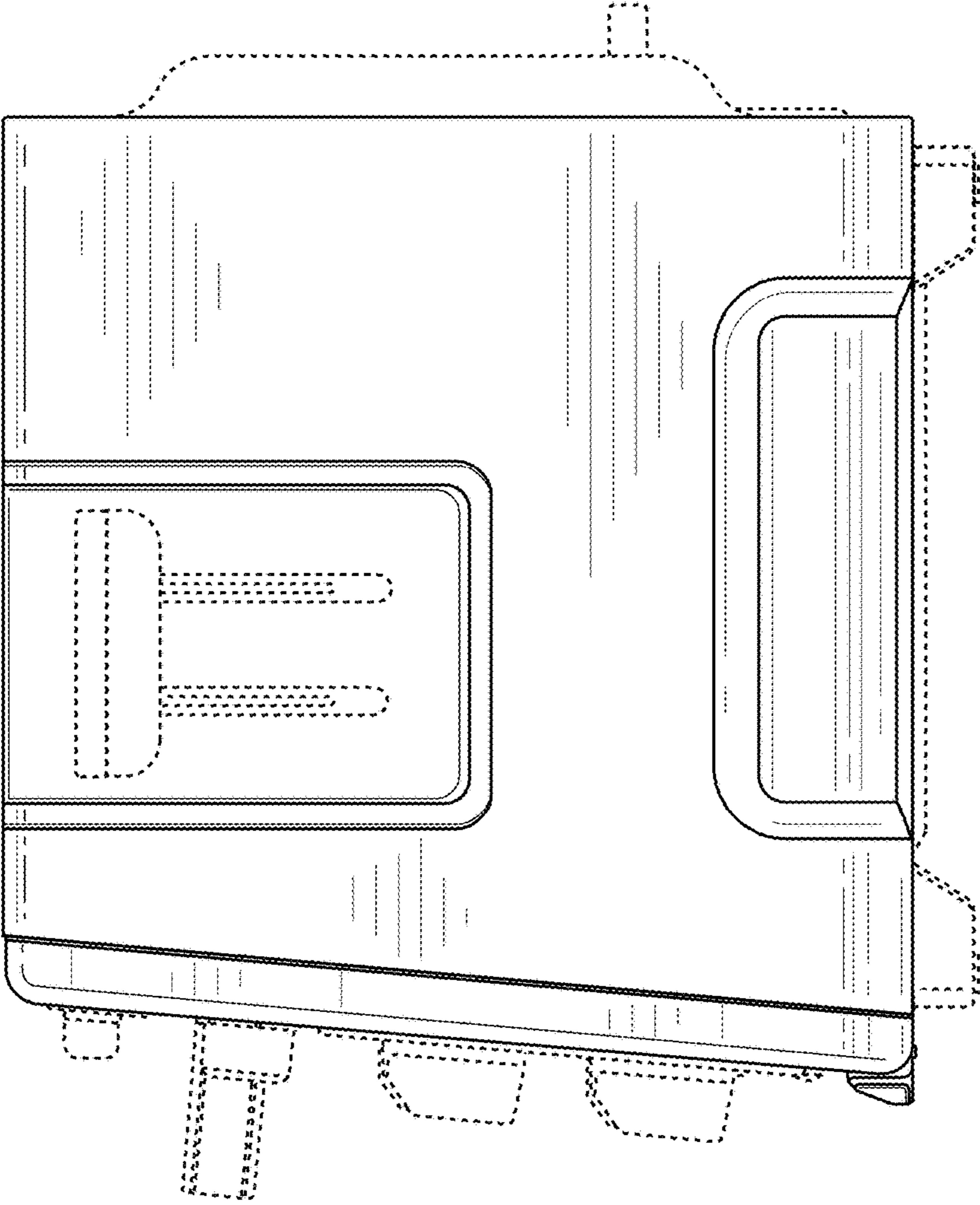
**FIG. 2**



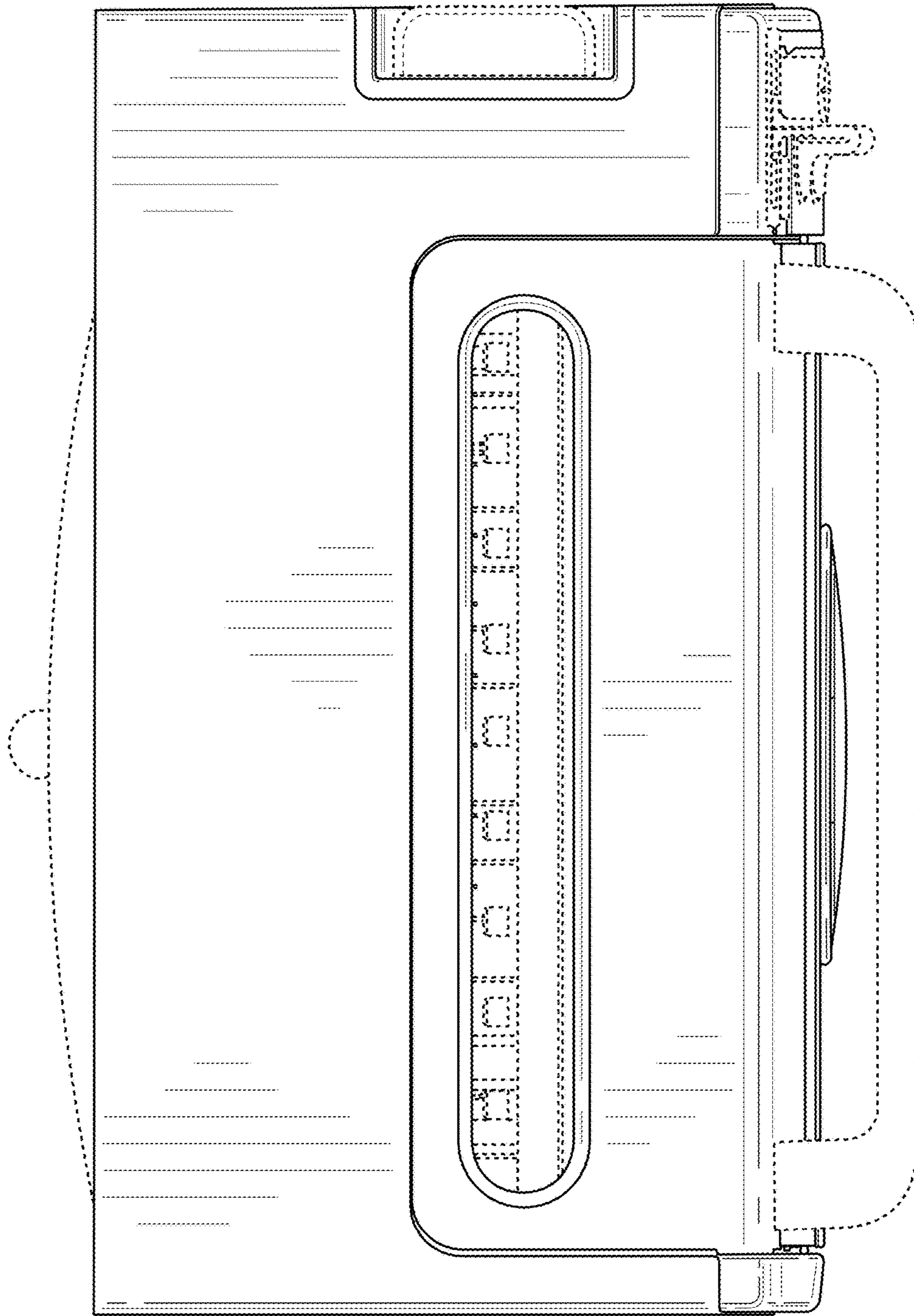
**FIG. 3**



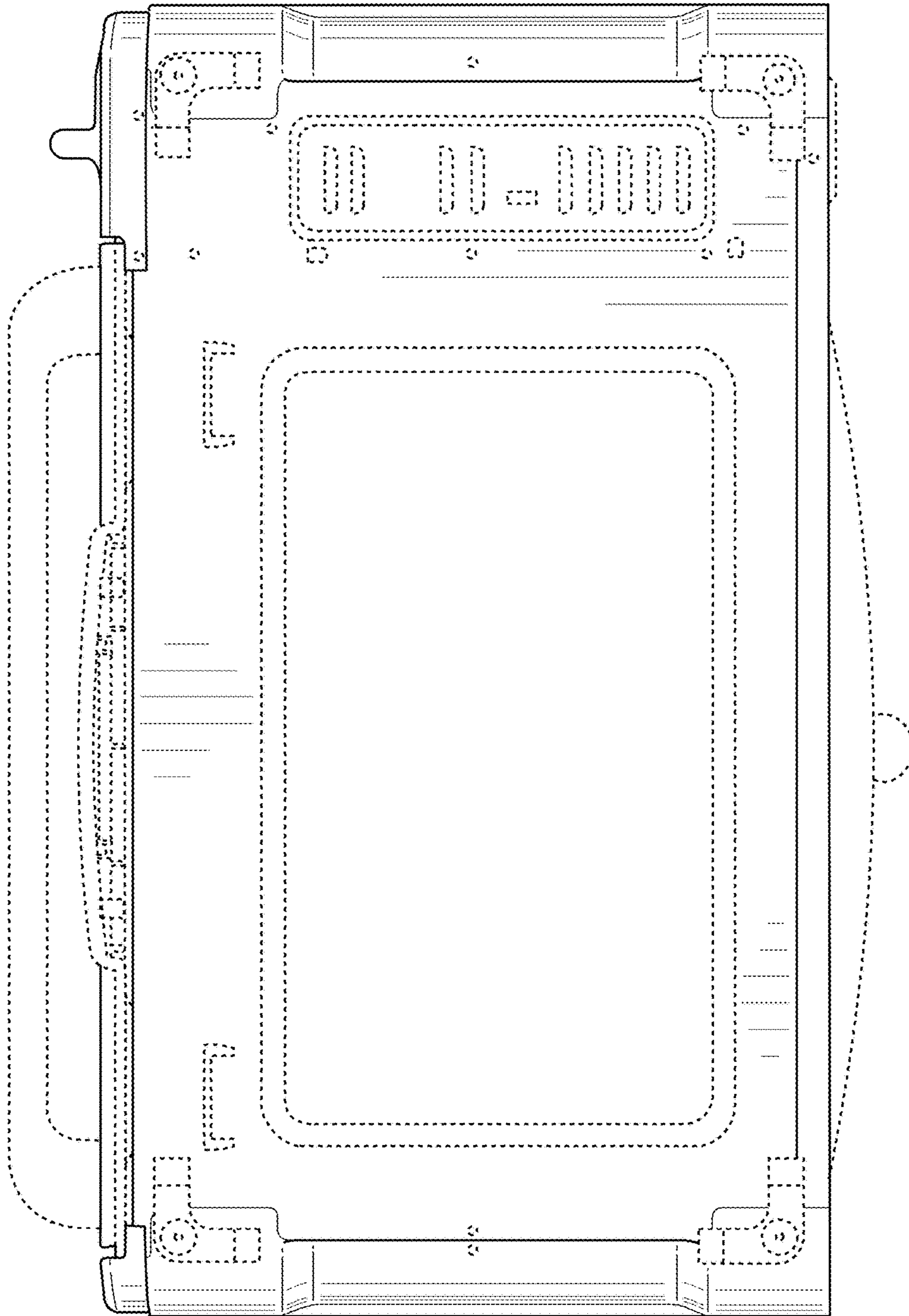
**FIG. 4**



**FIG. 5**



**FIG. 6**



**FIG. 7**