



US00D788500S

(12) **United States Design Patent** (10) **Patent No.:** **US D788,500 S**  
**Fu** (45) **Date of Patent:** **\*\* Jun. 6, 2017**

(54) **TOOL CUPBOARDS**

(71) Applicant: **Ningbo Vertak Mechanical & Electronic Co., Ltd., Ningbo (CN)**  
(72) Inventor: **Yi-Qiao Fu, Ningbo (CN)**  
(73) Assignee: **Ningbo Vertak Mechanical & Electrical Co., Ltd., Ningbo (CN)**  
(\*\*) Term: **15 Years**  
(21) Appl. No.: **29/529,637**  
(22) Filed: **Jun. 9, 2015**  
(51) **LOC (10) Cl.** ..... **06-04**  
(52) **U.S. Cl.**  
USPC ..... **D6/671**  
(58) **Field of Classification Search**  
USPC ..... D3/276, 279, 281-284, 286, 295, 297,  
D3/318-319, 905; D6/657, 662, 663,  
(Continued)

(56) **References Cited**

**U.S. PATENT DOCUMENTS**

D381,166 S \* 7/1997 Bonazza ..... D34/19  
D444,960 S \* 7/2001 Sato ..... D18/59  
(Continued)

*Primary Examiner* — Ricky Pham  
(74) *Attorney, Agent, or Firm* — Wang Law Firm, Inc.

(57) **CLAIM**

The ornamental design for a tool cupboards, as shown and described.

**DESCRIPTION**

FIG. 1 is a front view of the tool cupboards showing my new design;  
FIG. 2 is a back side view thereof;  
FIG. 3 is a left side view thereof;  
FIG. 4 is a right view thereof;

FIG. 5 is a top plan view thereof;  
FIG. 6 is a bottom plan view thereof;  
FIG. 7 is a perspective view thereof;  
FIG. 8 is a front view of the top plate;  
FIG. 9 is a back side view thereof;  
FIG. 10 is a left side view thereof;  
FIG. 11 is a right view thereof;  
FIG. 12 is a top plan view thereof;  
FIG. 13 is a bottom plan view thereof;  
FIG. 14 is a perspective view thereof;  
FIG. 15 is a front view of the first drawer;  
FIG. 16 is a back side view thereof;  
FIG. 17 is a left side view thereof;  
FIG. 18 is a right view thereof;  
FIG. 19 is a top plan view thereof;  
FIG. 20 is a bottom plan view thereof;  
FIG. 21 is a perspective view thereof;  
FIG. 22 is a front view of the second drawer;  
FIG. 23 is a back side view thereof;  
FIG. 24 is a left side view thereof;  
FIG. 25 is a right view thereof;  
FIG. 26 is a top plan view thereof;  
FIG. 27 is a bottom plan view thereof;  
FIG. 28 is a perspective view thereof;  
FIG. 29 is a front view of the first box;  
FIG. 30 is a back side view thereof;  
FIG. 31 is a left side view thereof;  
FIG. 32 is a right view thereof;  
FIG. 33 is a top plan view thereof;  
FIG. 34 is a bottom plan view thereof;  
FIG. 35 is a perspective view thereof;  
FIG. 36 is a front view of the second box;  
FIG. 37 is a back side view thereof;  
FIG. 38 is a left side view thereof;  
FIG. 39 is a right view thereof;  
FIG. 40 is a top plan view thereof;  
FIG. 41 is a bottom plan view thereof;  
FIG. 42 is a perspective view thereof;  
FIG. 43 is a front view of the third box;  
FIG. 44 is a back side view thereof;  
FIG. 45 is a left side view thereof;  
FIG. 46 is a right view thereof;  
FIG. 47 is a top plan view thereof;  
FIG. 48 is a bottom plan view thereof;

(Continued)

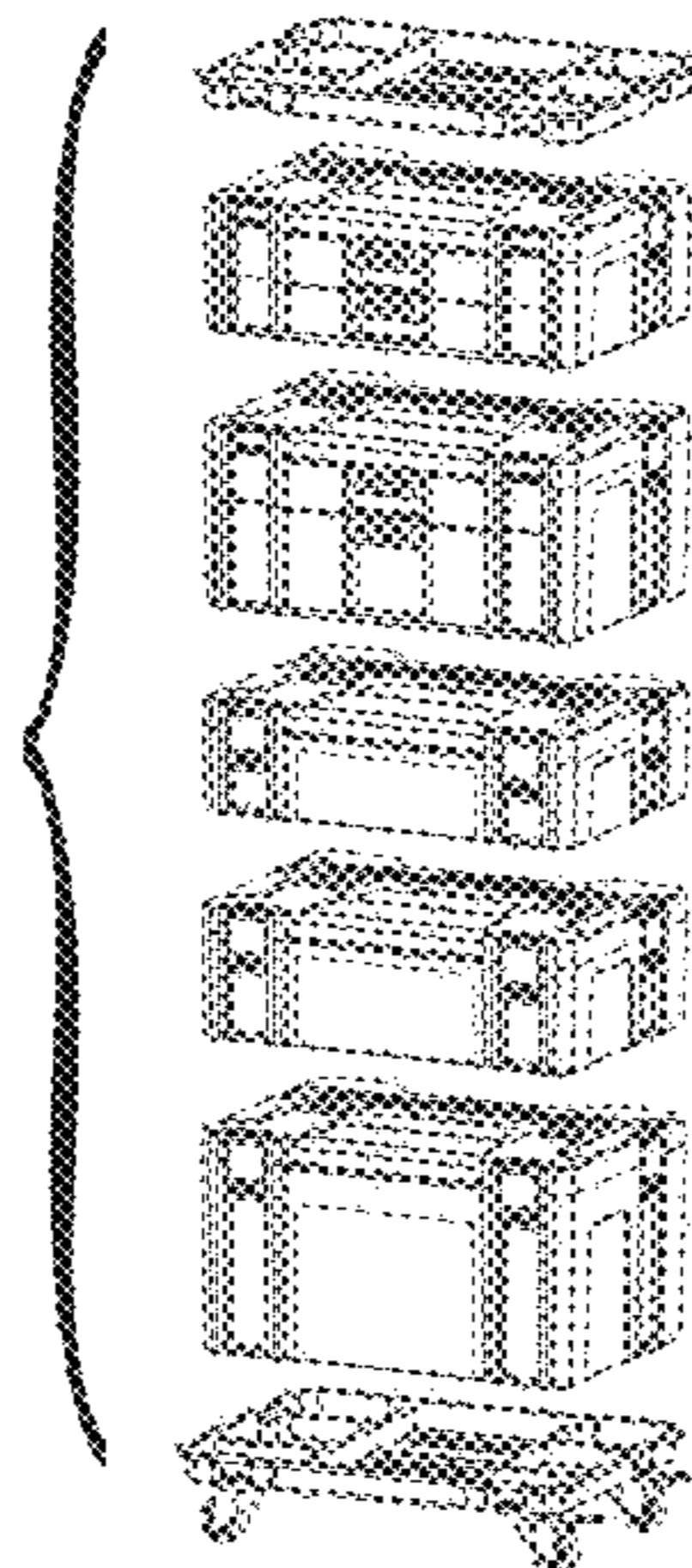

FIG. 49 is a perspective view thereof;  
 FIG. 50 is a front view of the pedestal;  
 FIG. 51 is a back side view thereof;  
 FIG. 52 is a left side view thereof;  
 FIG. 53 is a right view thereof;  
 FIG. 54 is a top plan view thereof;  
 FIG. 55 is a bottom plan view thereof;  
 FIG. 56 is a perspective view thereof; and,  
 FIG. 57 is an exploded view of the tool cupboards.

**1 Claim, 57 Drawing Sheets**

(58) **Field of Classification Search**

USPC ..... D6/664.1, 668, 668.1, 668.2, 669, 671,  
 D6/671.1, 671.2, 671.3, 671.4, 705,  
 D6/705.5; D34/19, 20, 21  
 CPC ..... A47B 49/00; A47B 49/002; A47B 67/00;  
 A47B 67/04; A47B 87/02; A47B 88/04;  
 A47B 88/0411; A47B 88/20; A47B  
 97/00; A47B 2210/00; A47B 2210/004;  
 A47B 2210/0078; A47B 2210/0008;

A47F 3/00; B62B 3/00; B25H 3/00;  
 B25H 3/003; B25H 3/006; B25H 3/02;  
 B25H 3/021; B25H 3/026; B25H 3/028

See application file for complete search history.

(56)

**References Cited**

U.S. PATENT DOCUMENTS

D470,687	S	*	2/2003	Binse	.....	D6/657
D489,858	S	*	5/2004	Hay	.....	A47B 97/00
						D34/20
6,976,744	B2	*	12/2005	Hay	.....	A47B 97/00
						312/249.13
D517,805	S	*	3/2006	Hosking	.....	D3/291
D524,506	S	*	7/2006	Hay	.....	D34/20
D649,350	S	*	11/2011	Shitrit	.....	D3/281
D694,522	S	*	12/2013	Horovitz	.....	D3/281
D730,661	S	*	6/2015	Brunner	.....	D6/671
D738,106	S	*	9/2015	Shitrit	.....	D3/276
2010/0224527	A1	*	9/2010	Huang	.....	B25H 3/028
						206/503
2011/0181008	A1	*	7/2011	Bensman	.....	B25H 3/026
						280/47.26

\* cited by examiner



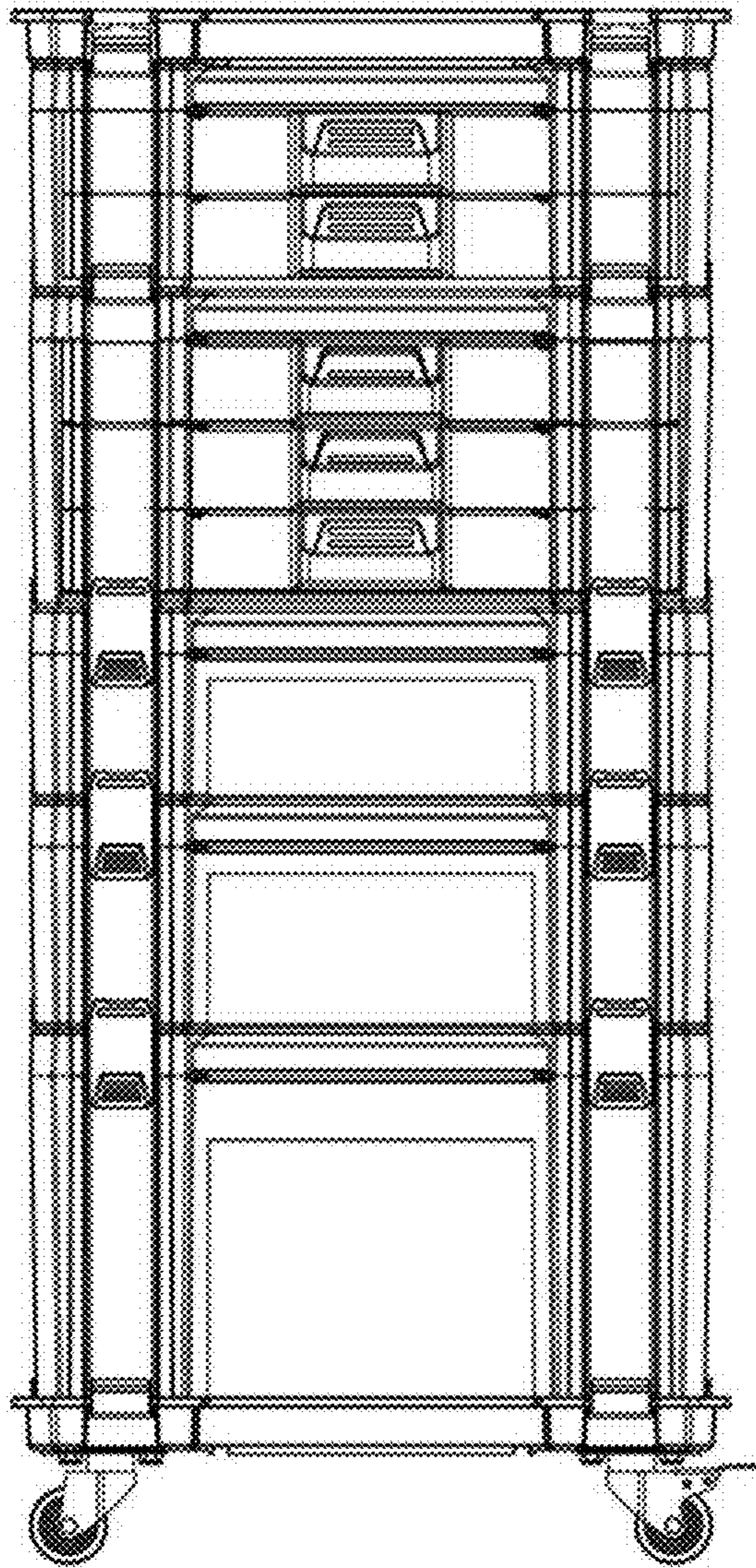

FIG. 1

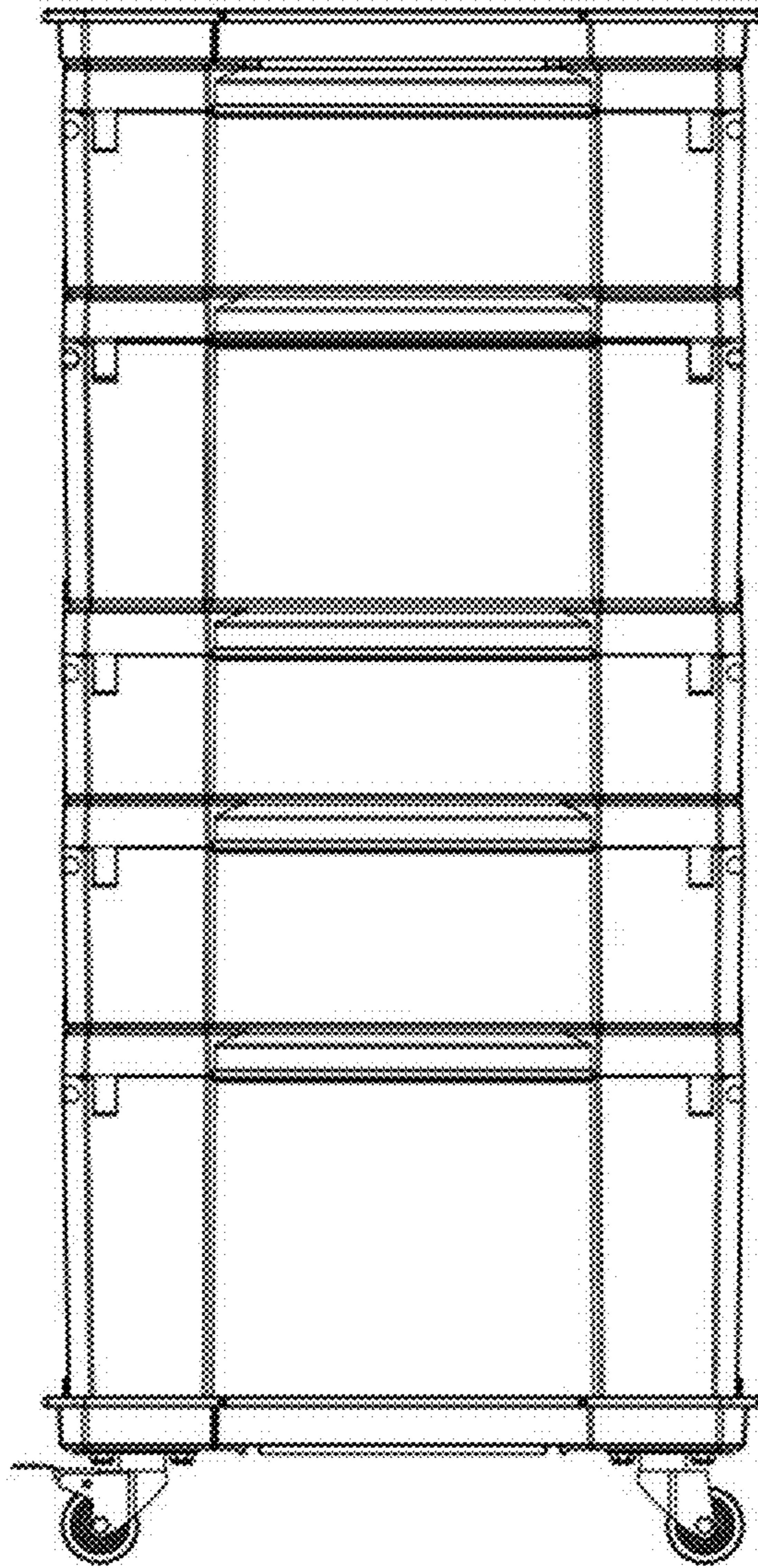

FIG. 2

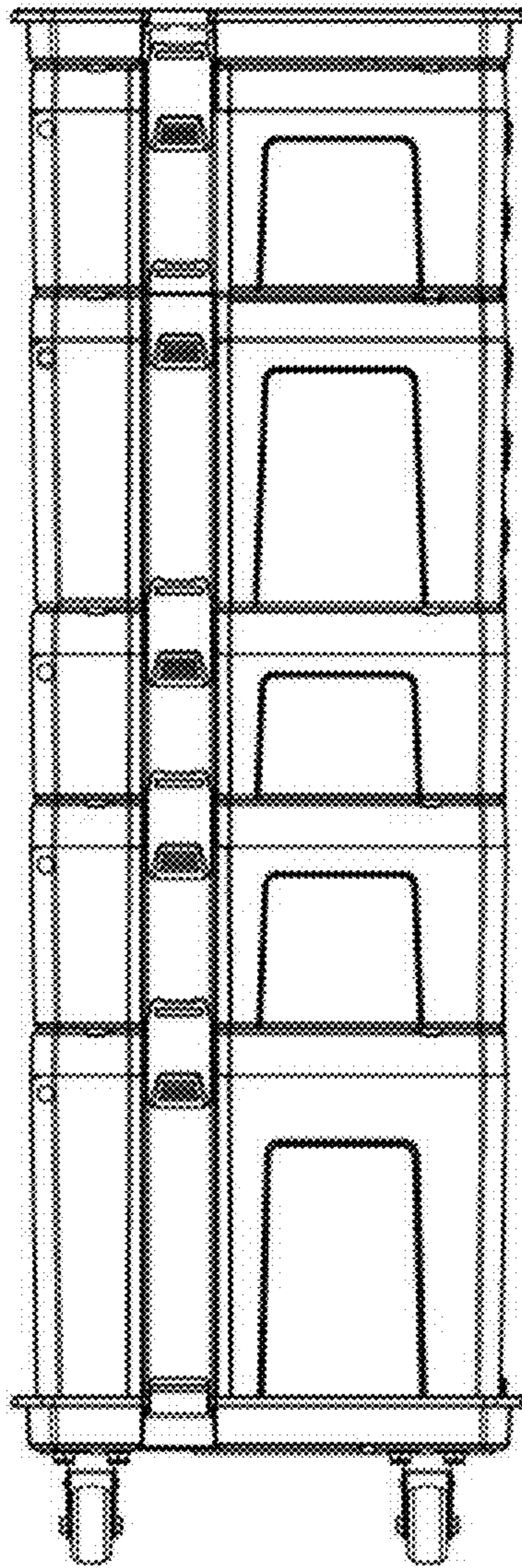

FIG. 3



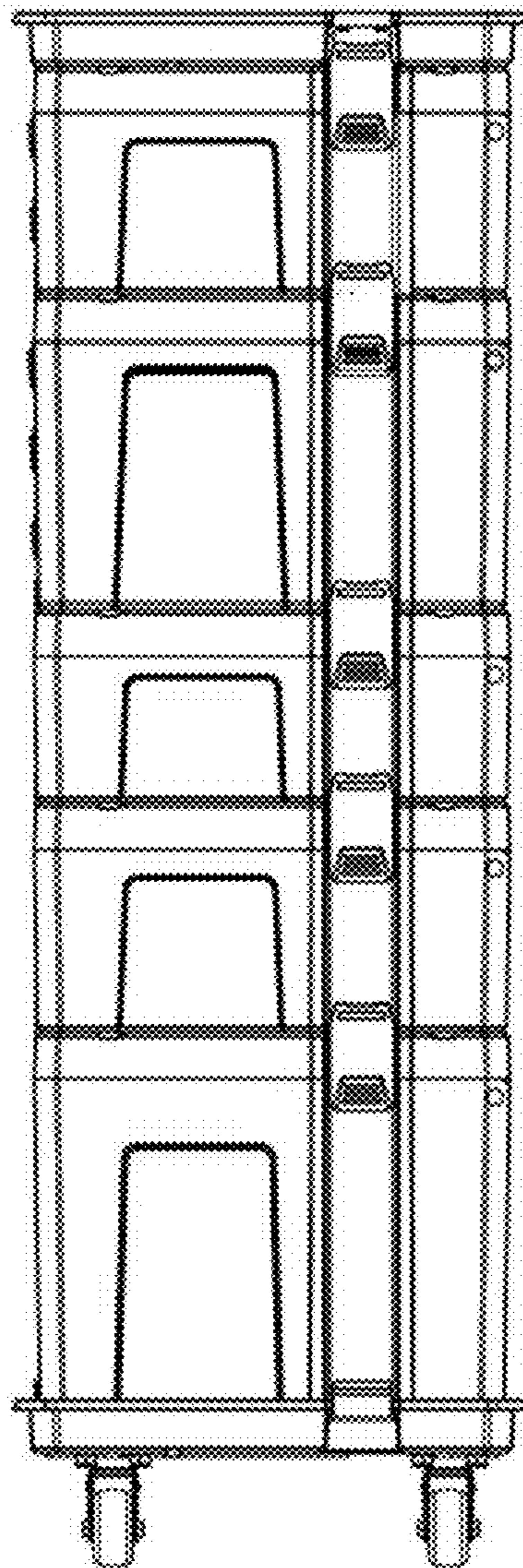

FIG. 4

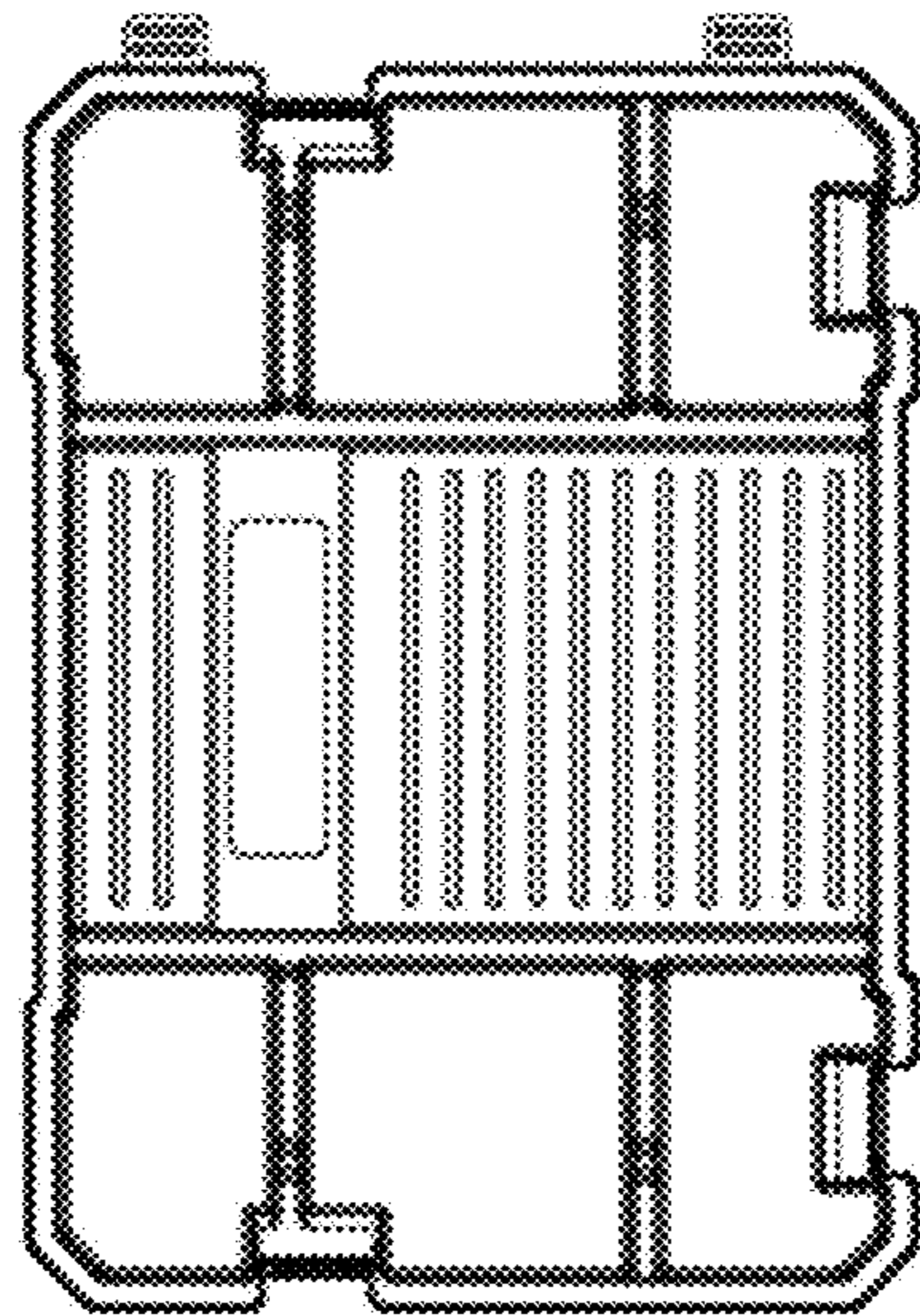

FIG. 5

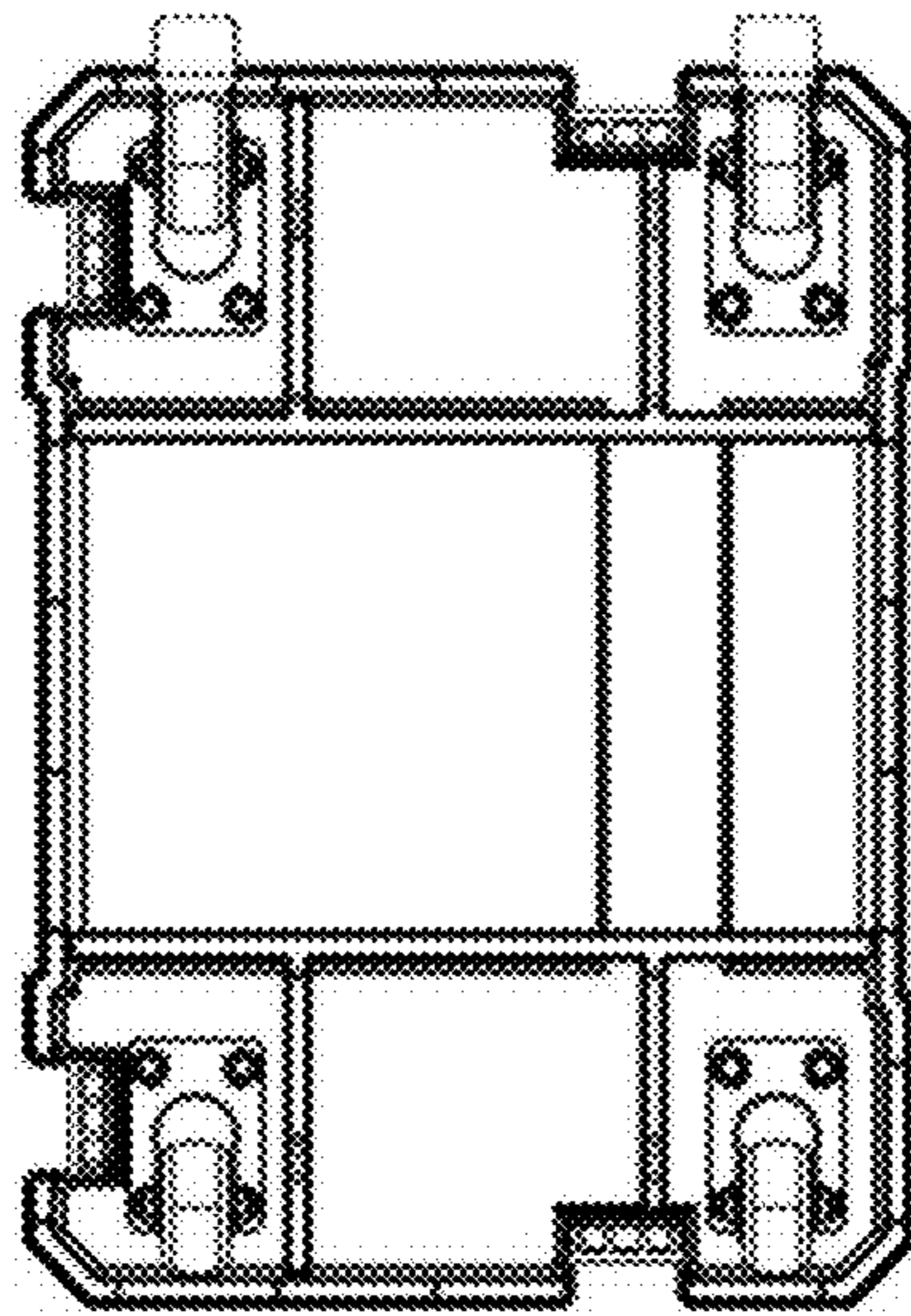

FIG. 6



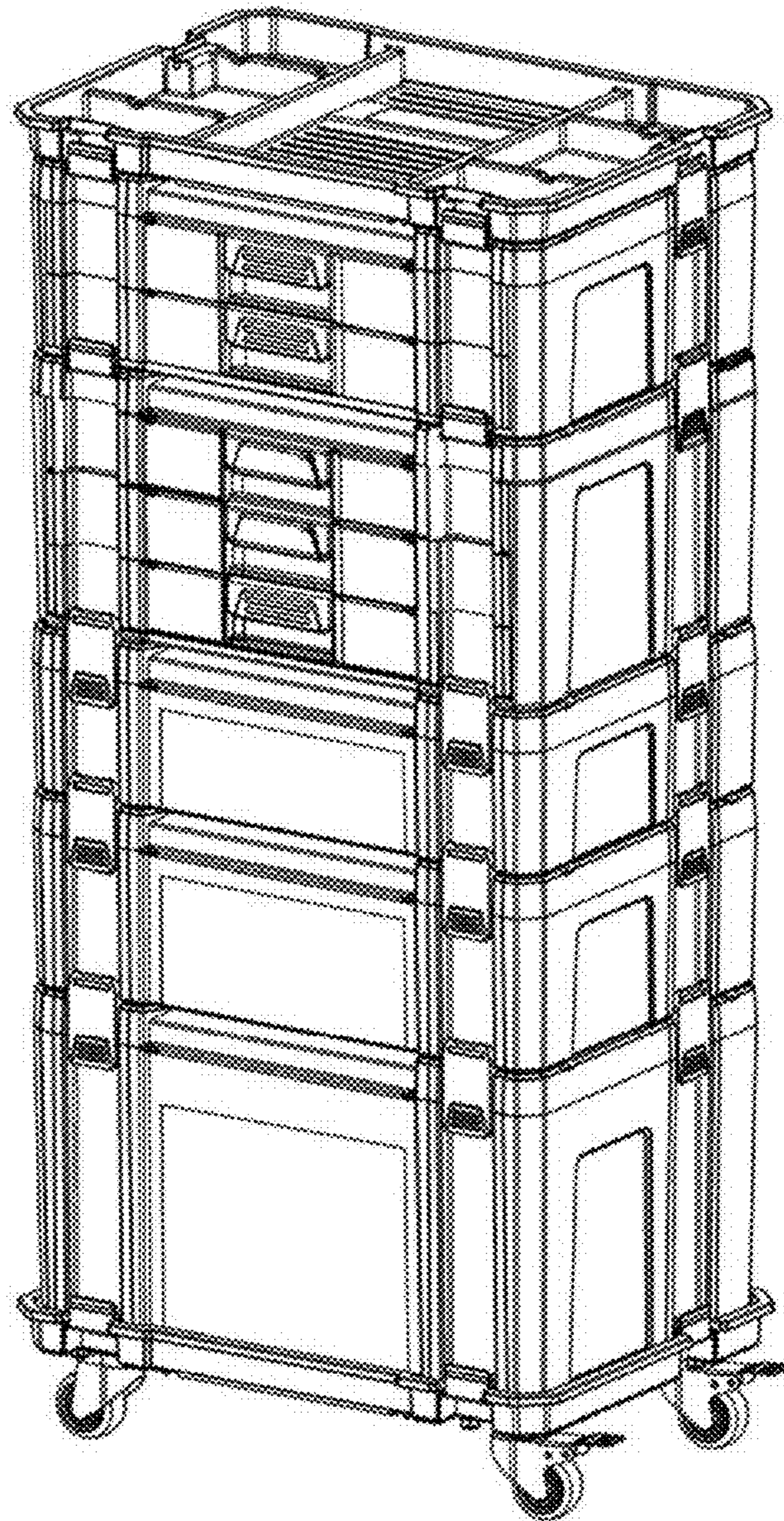

FIG. 7



FIG. 8

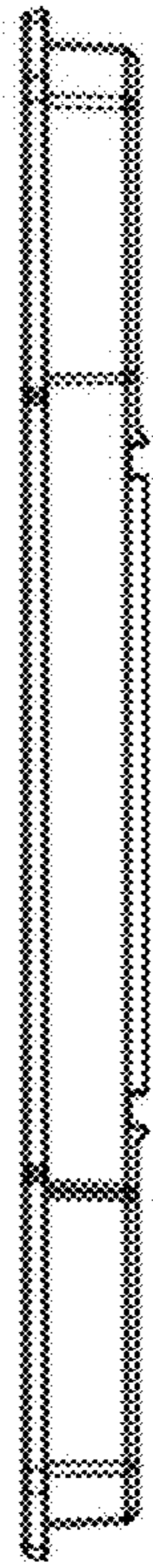

FIG. 9



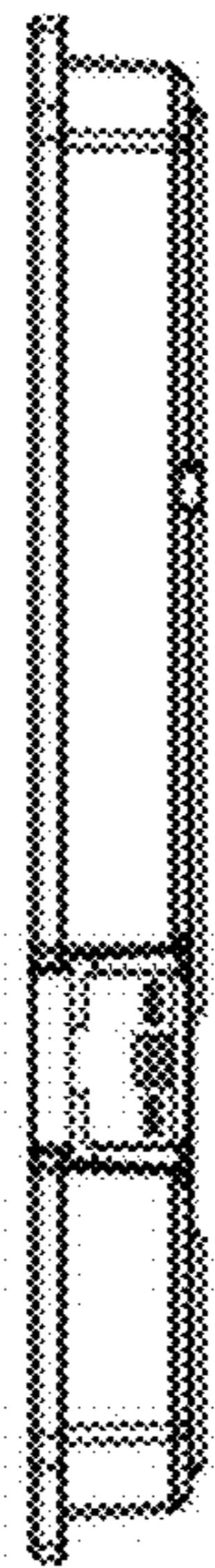

FIG. 10

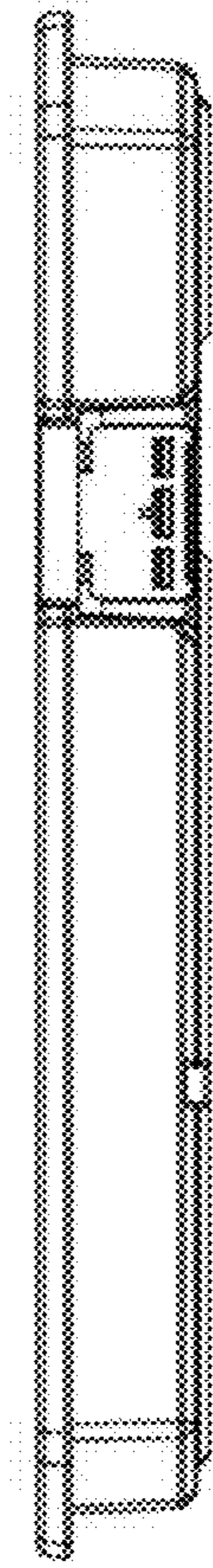

FIG. 11

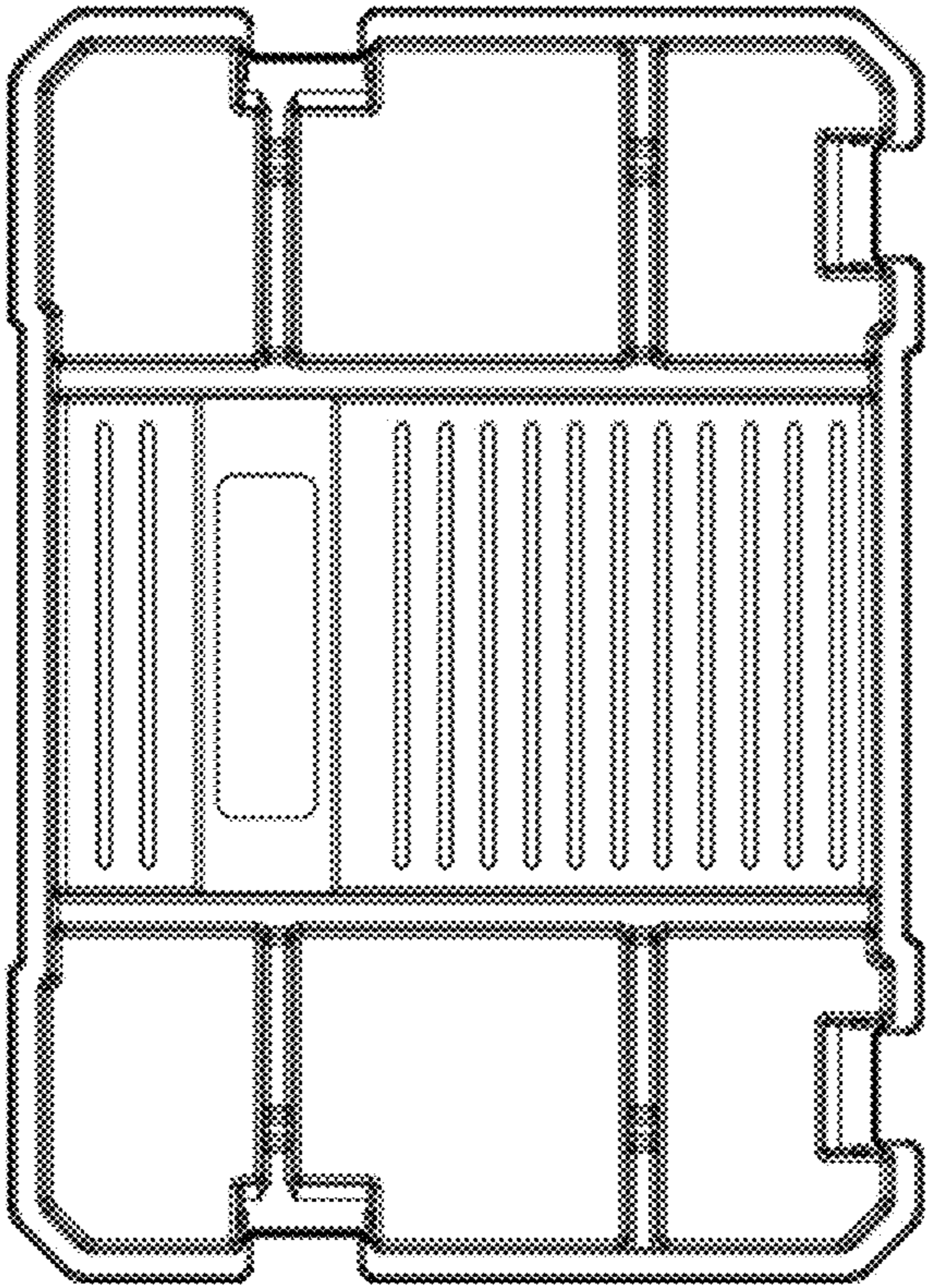

FIG. 12



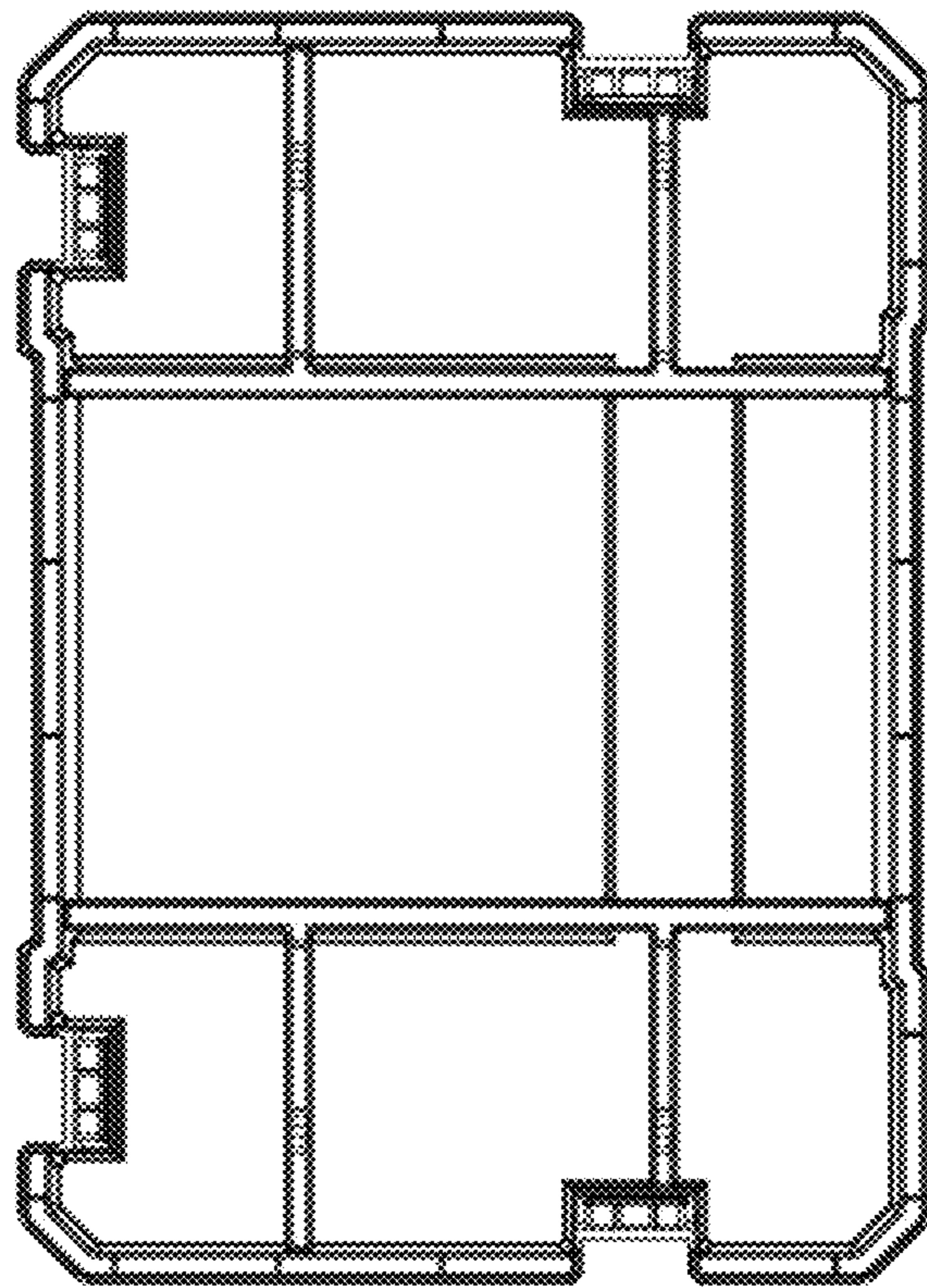

FIG. 13

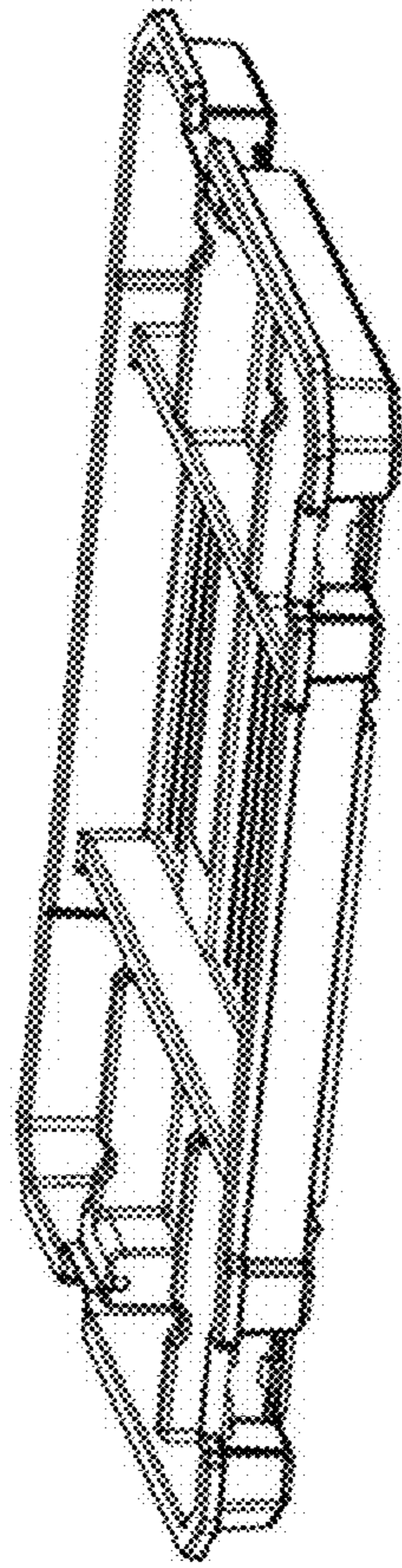

FIG. 14

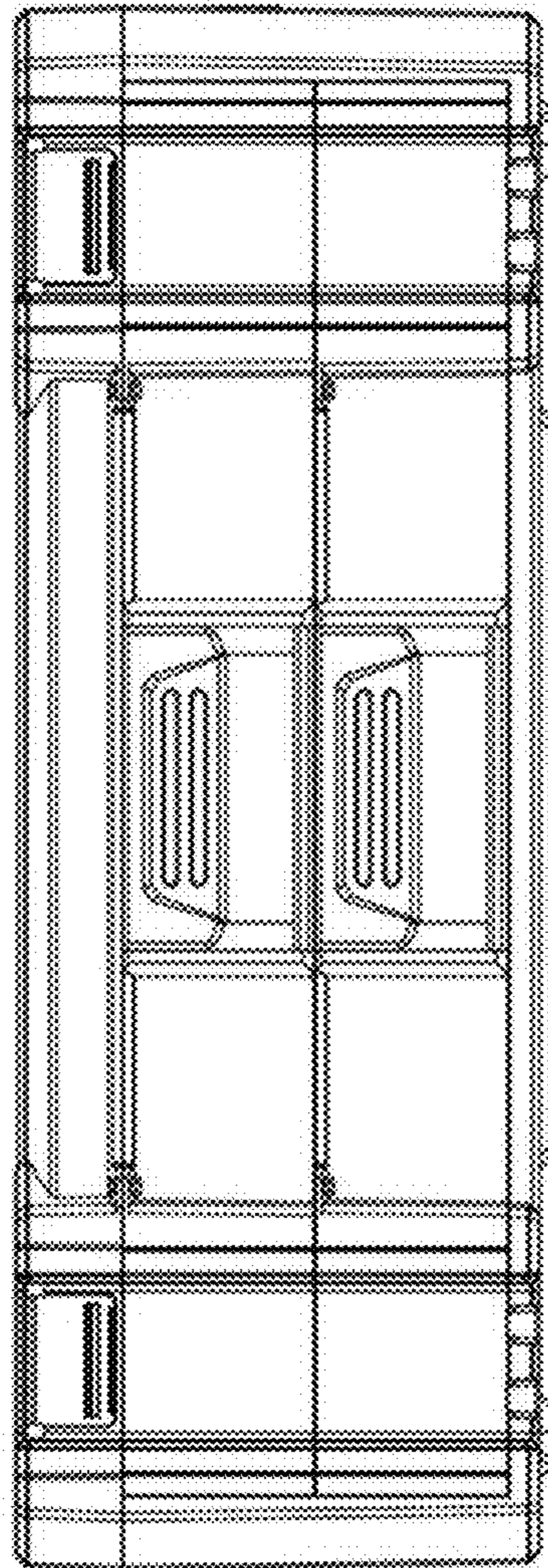

FIG. 15



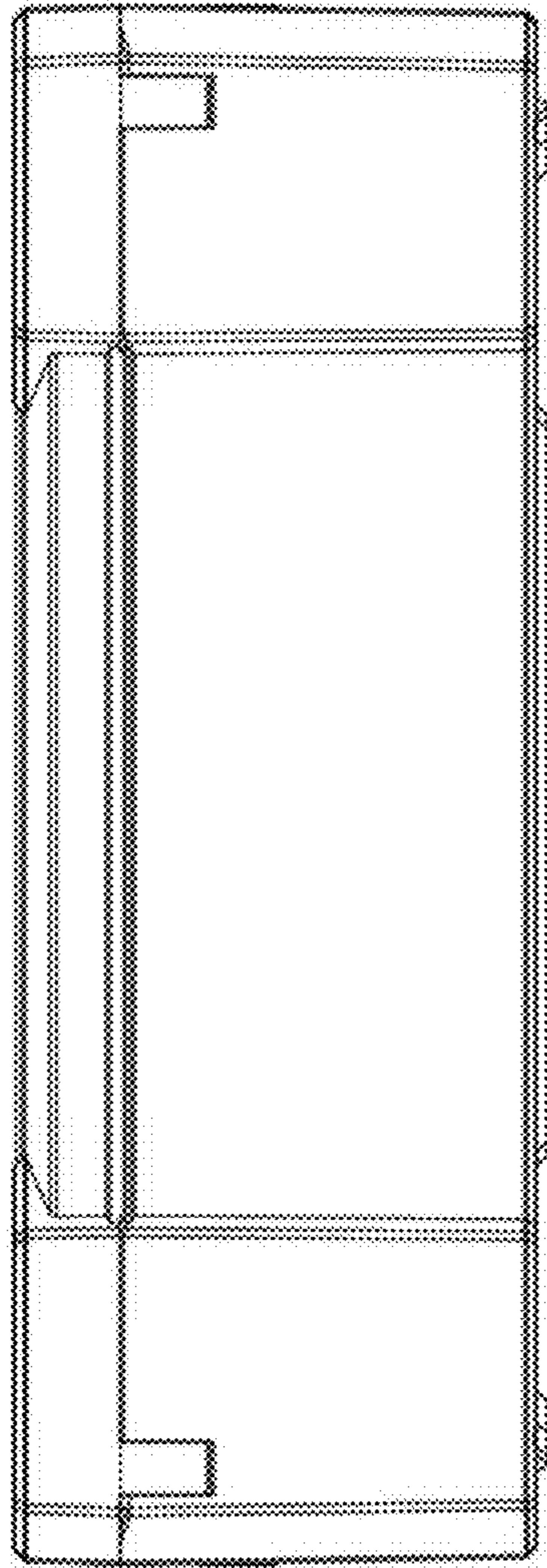

FIG. 16

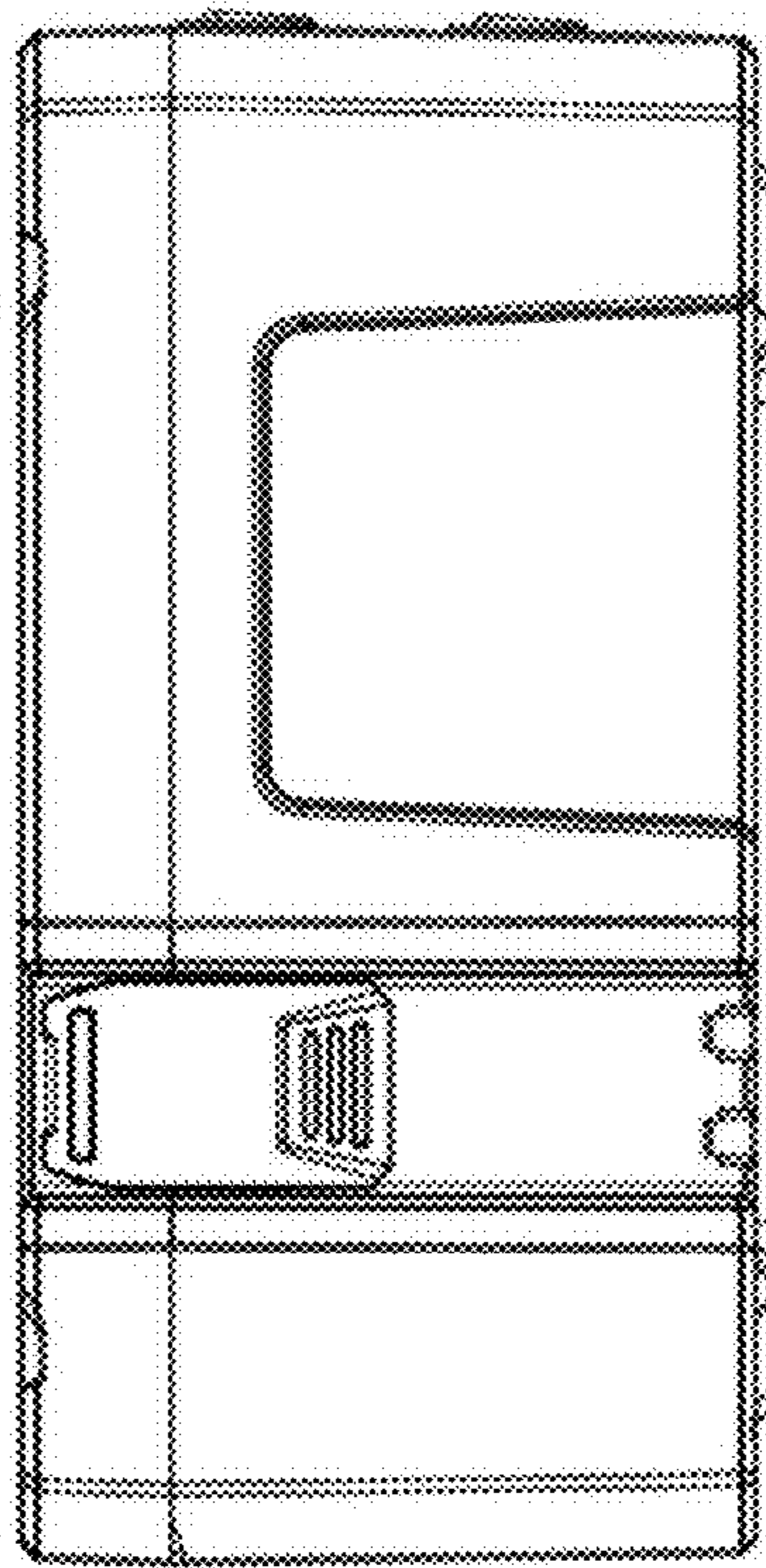

FIG. 17

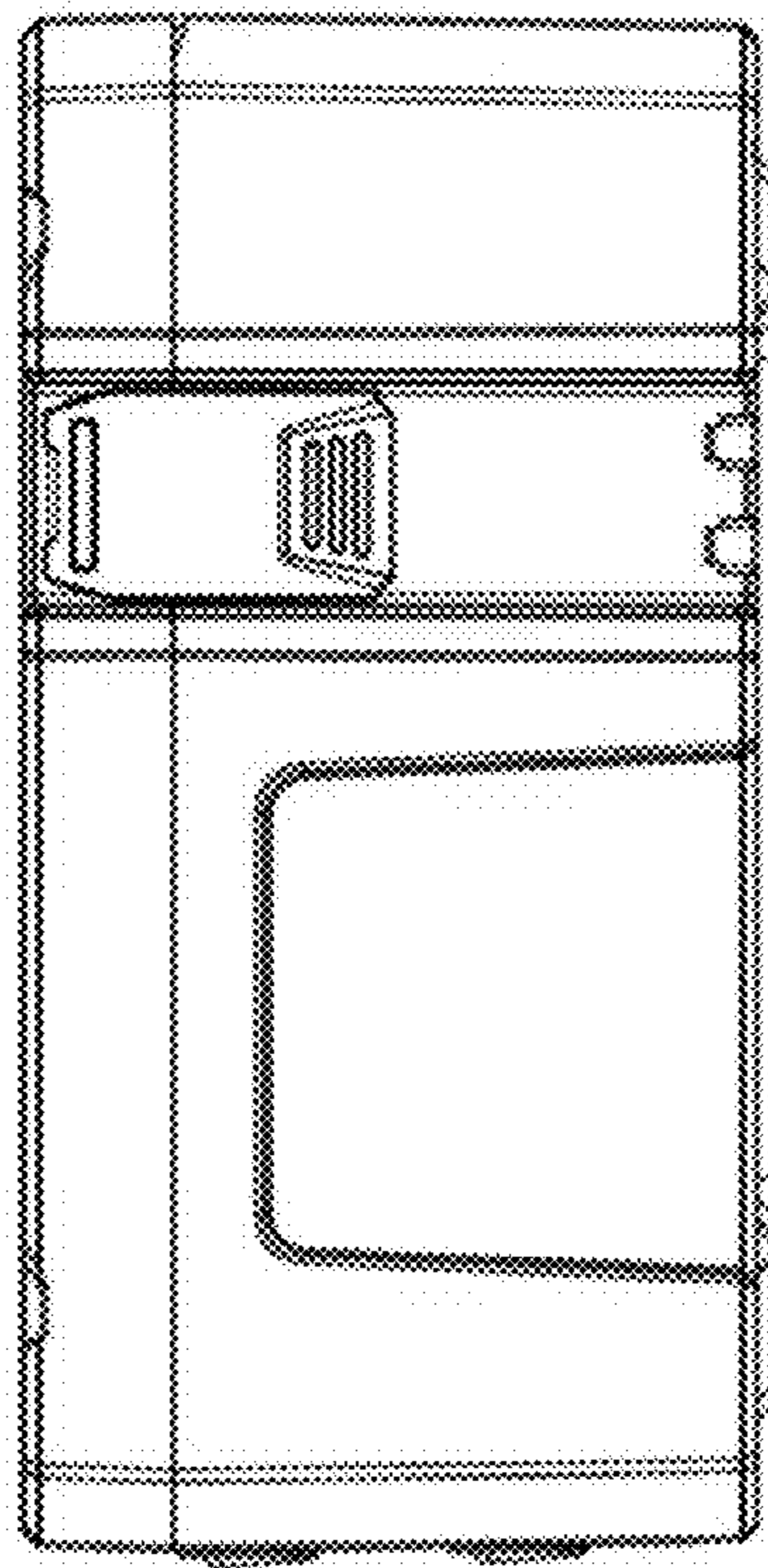

FIG. 18



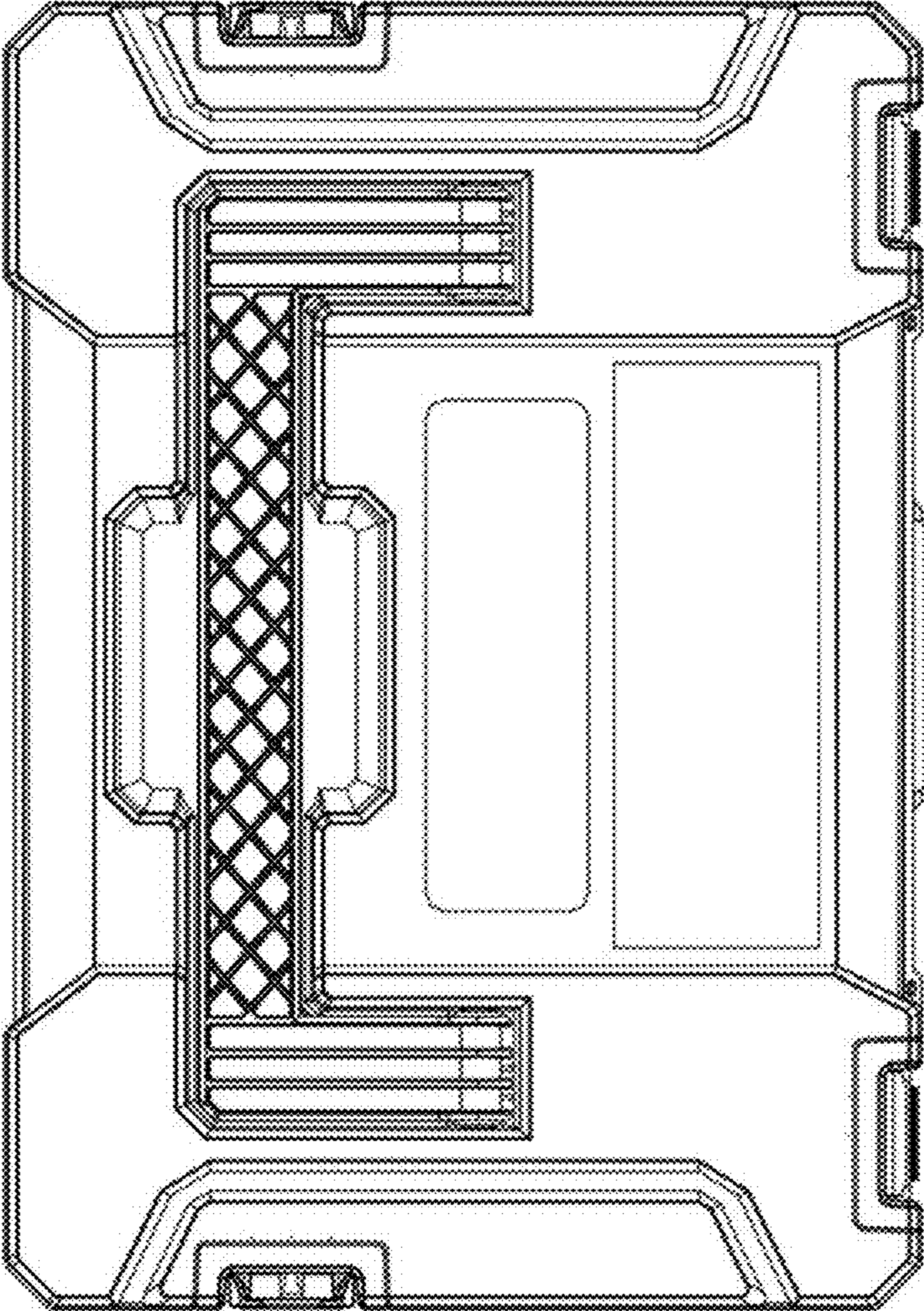

FIG. 19

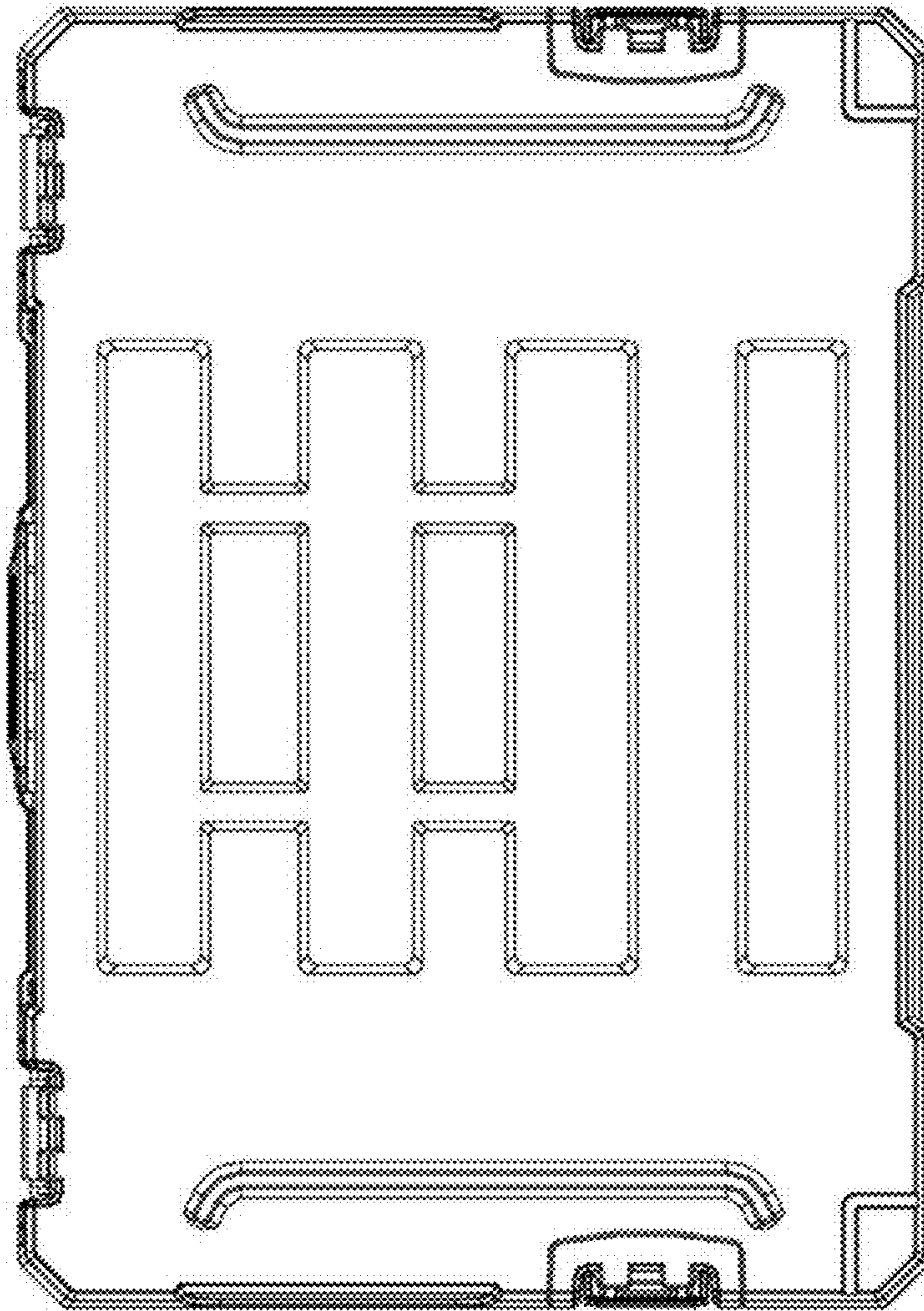

FIG. 20



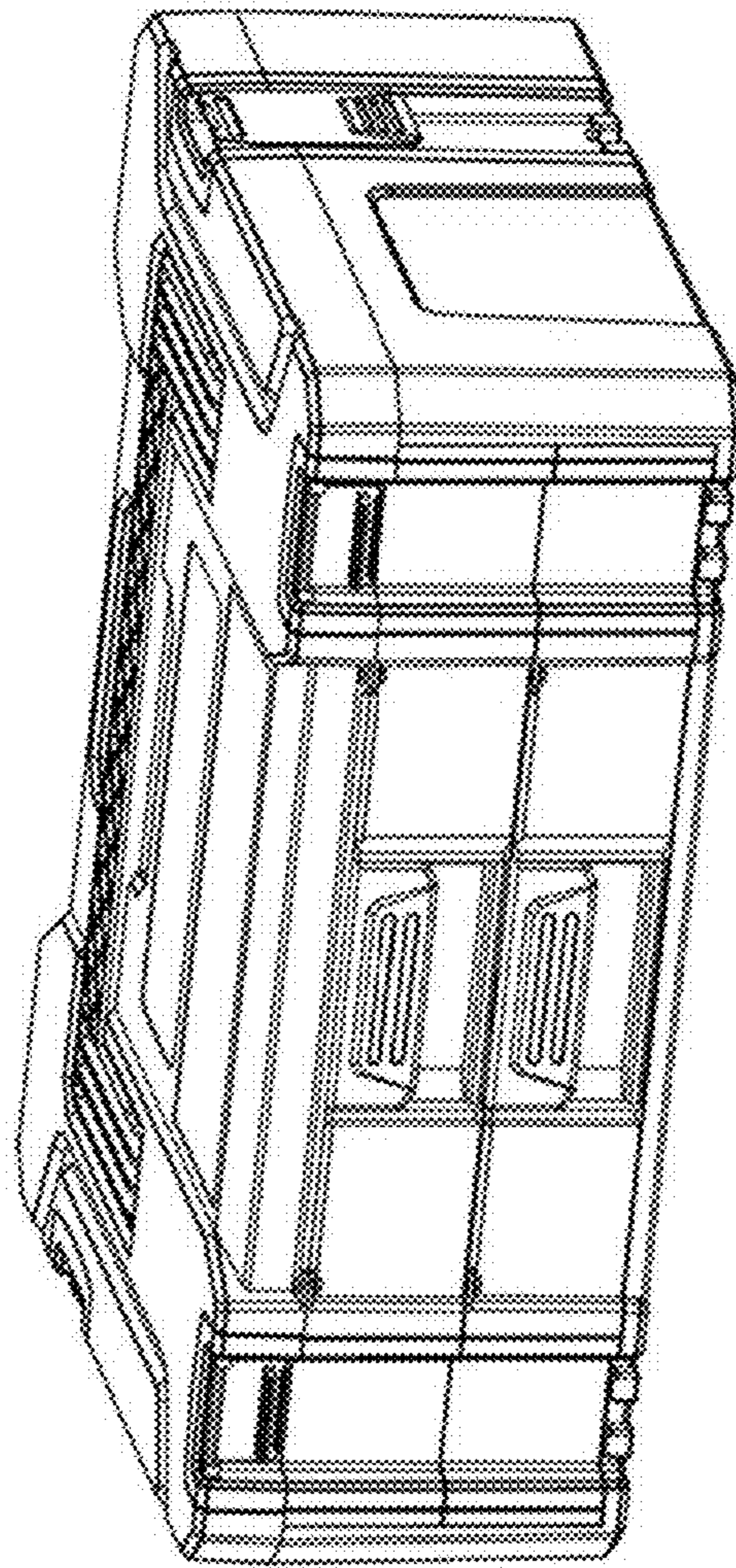

FIG. 21

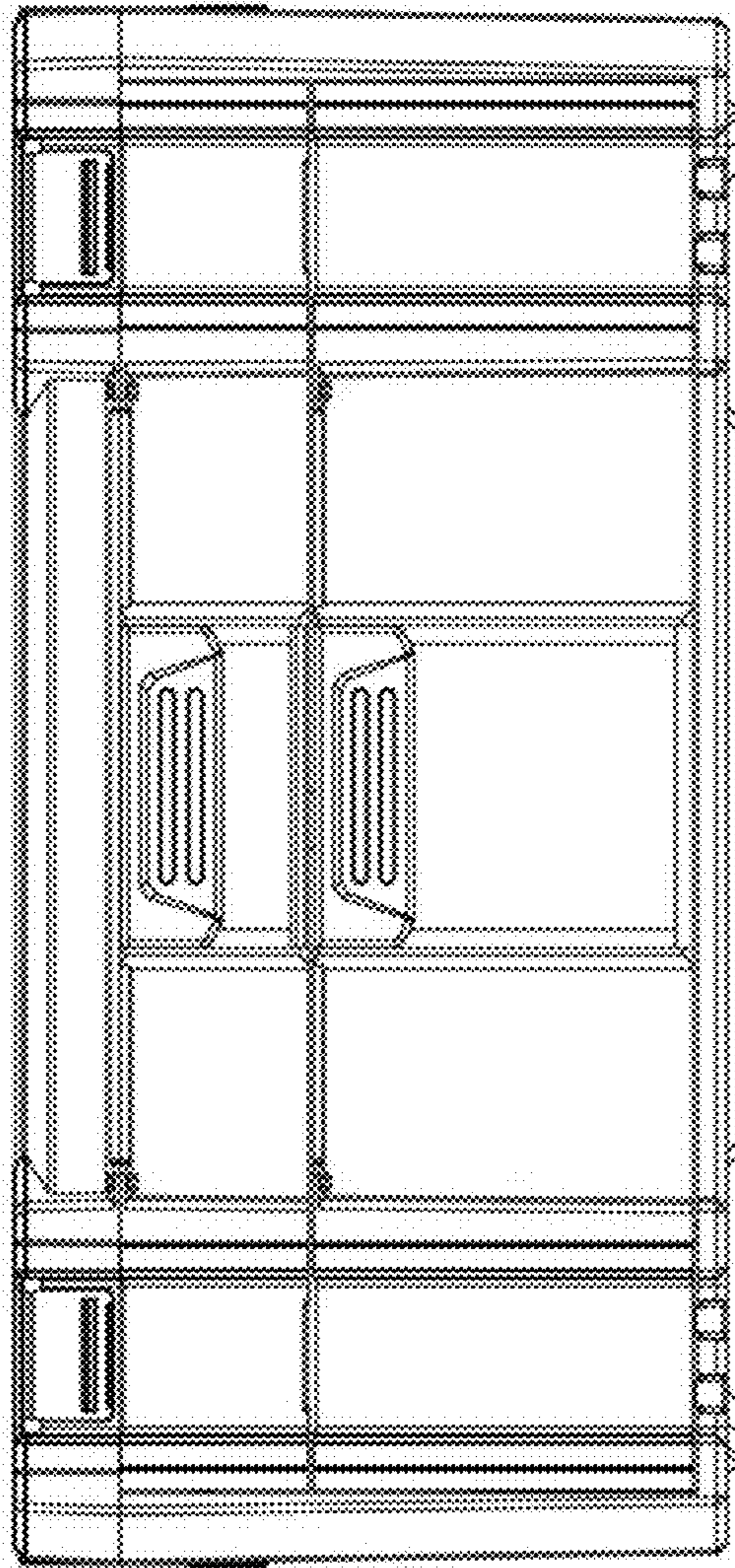

FIG. 22



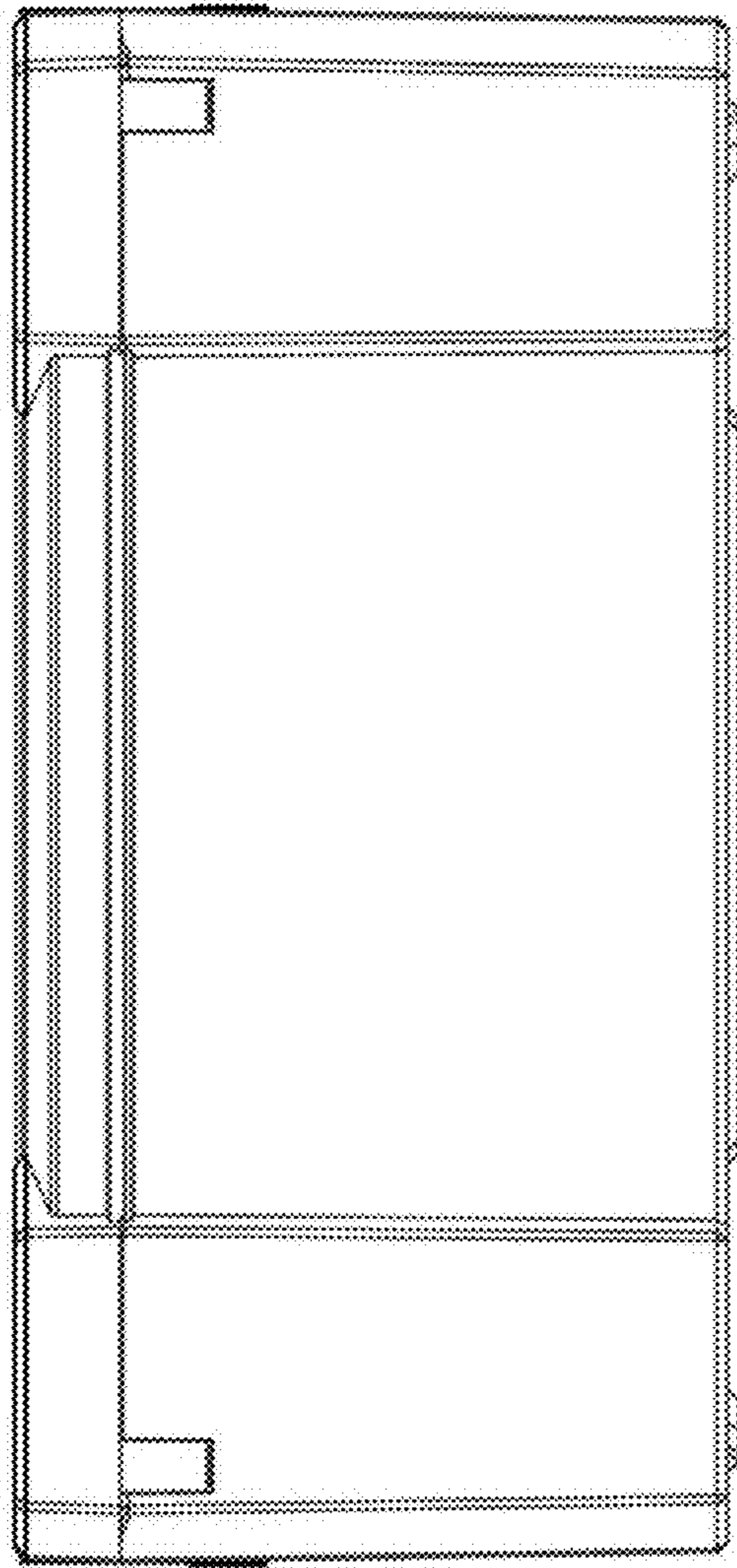

FIG. 23

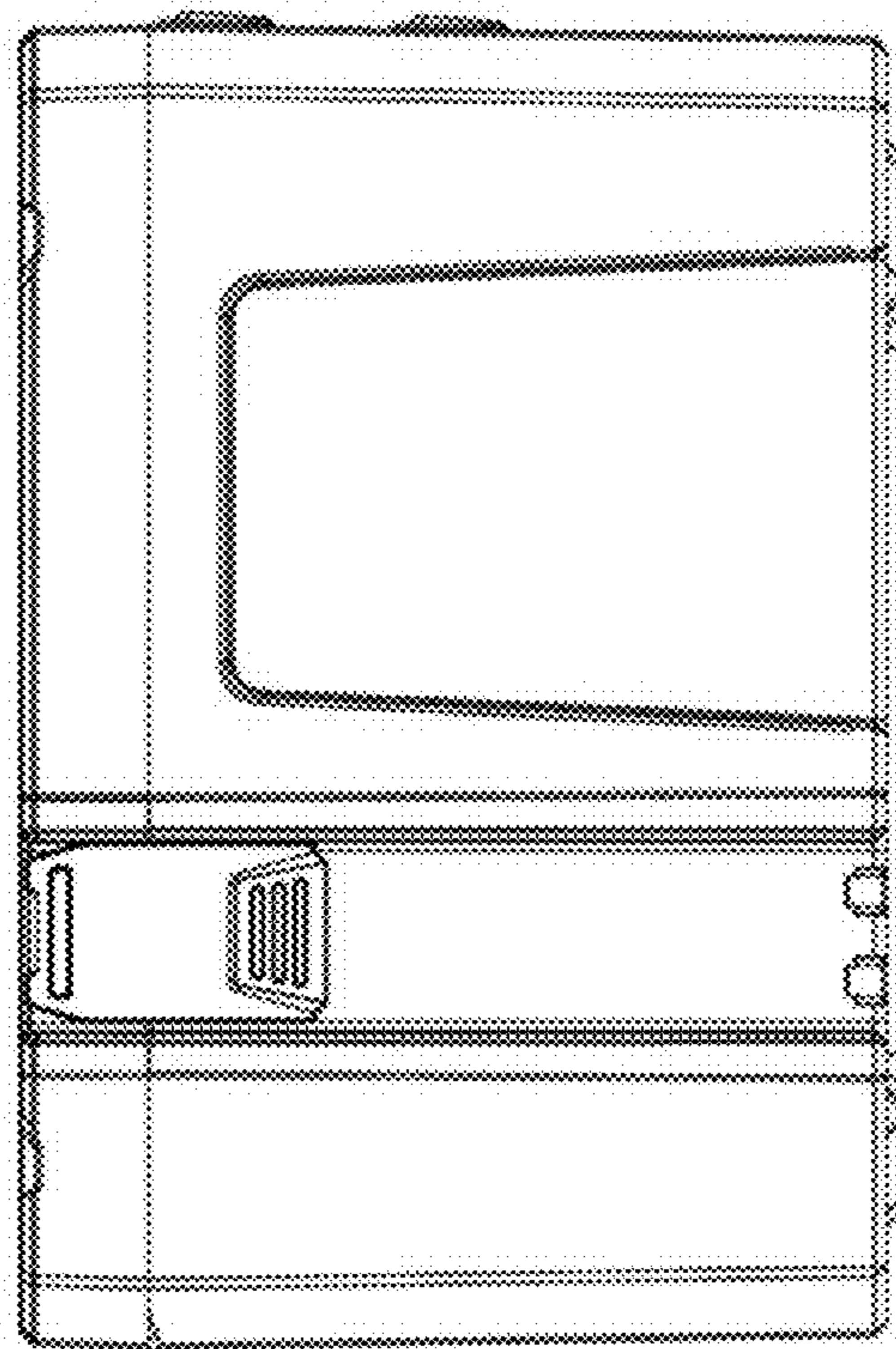

FIG. 24

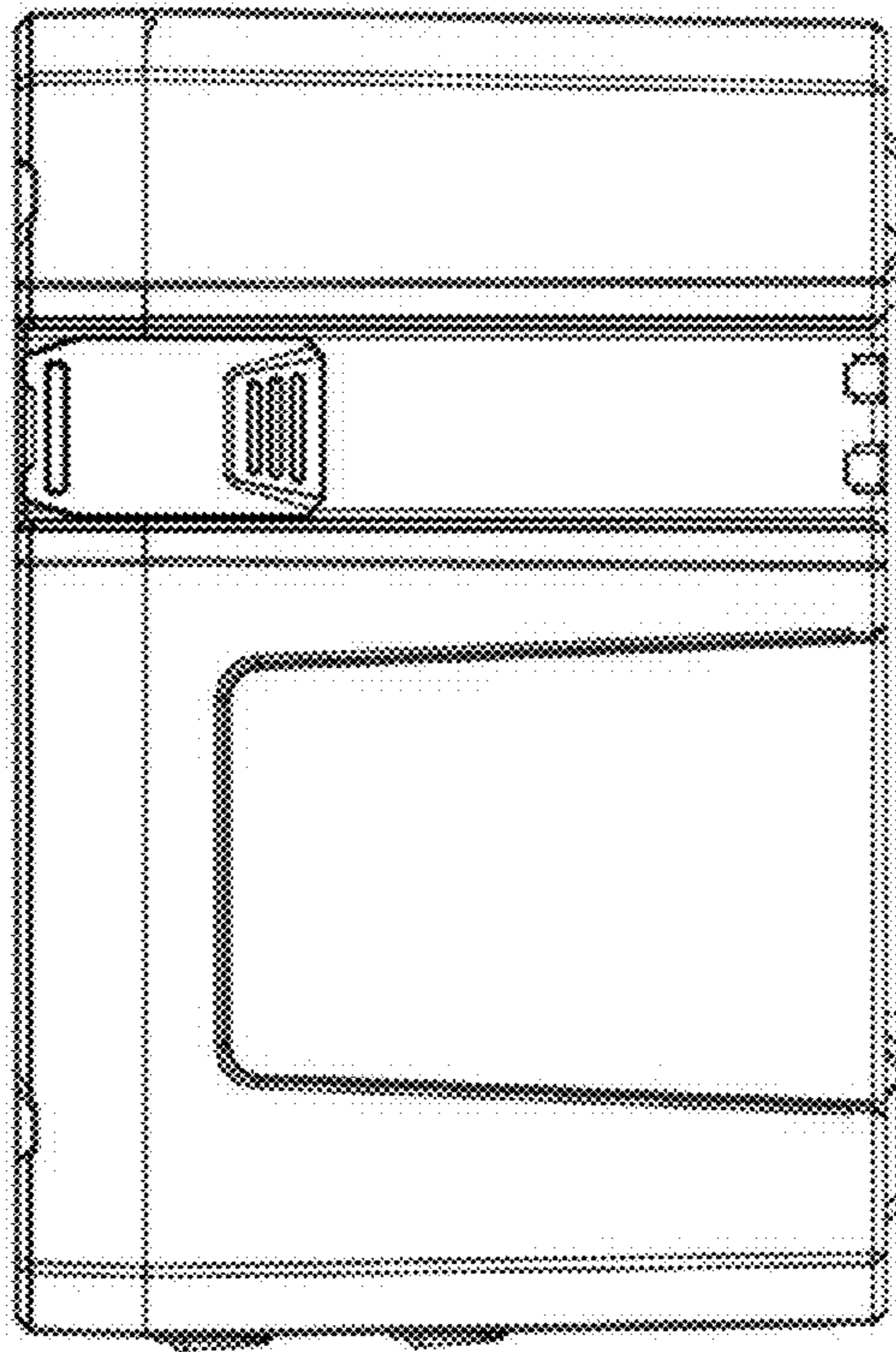

FIG. 25

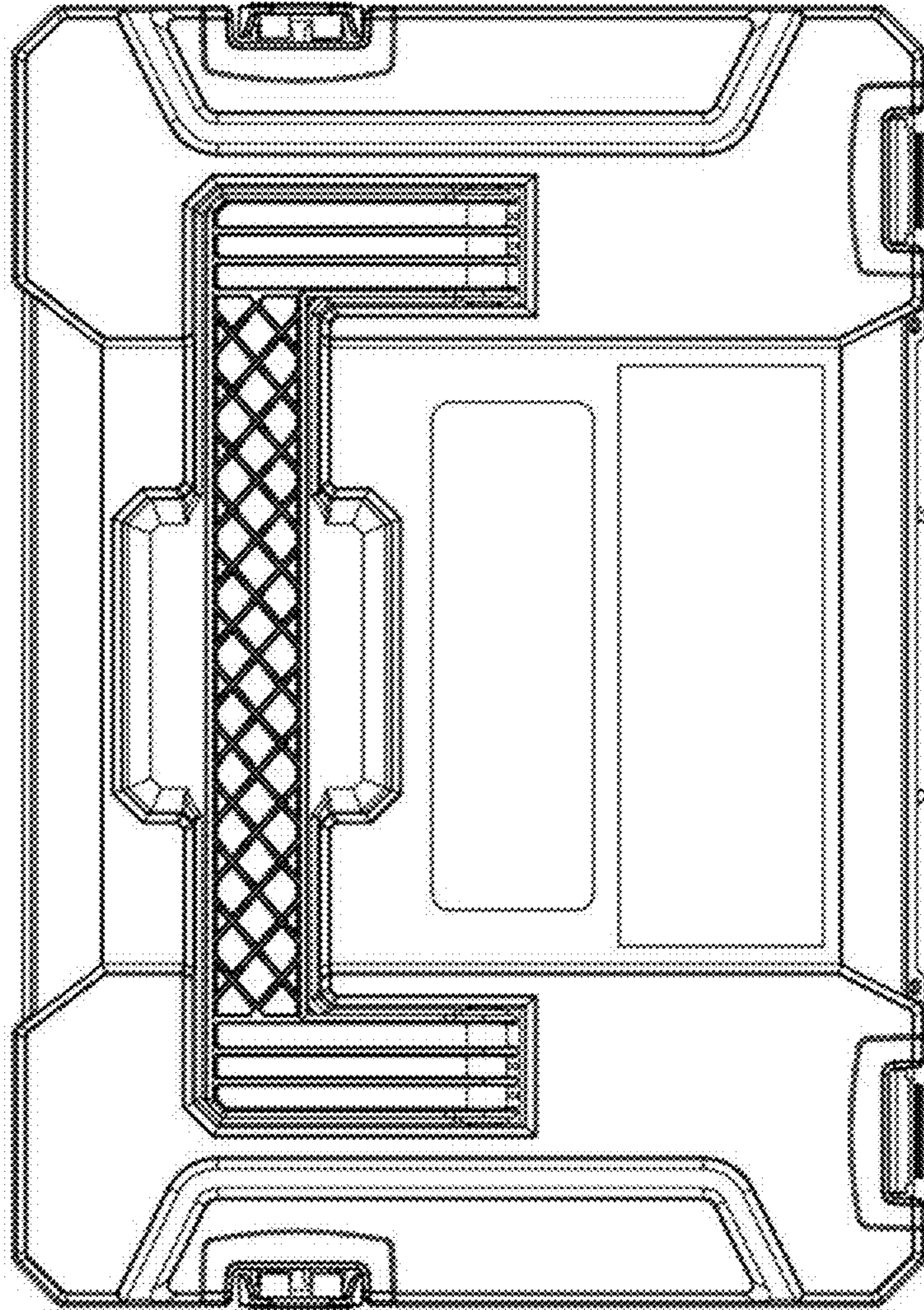

FIG. 26



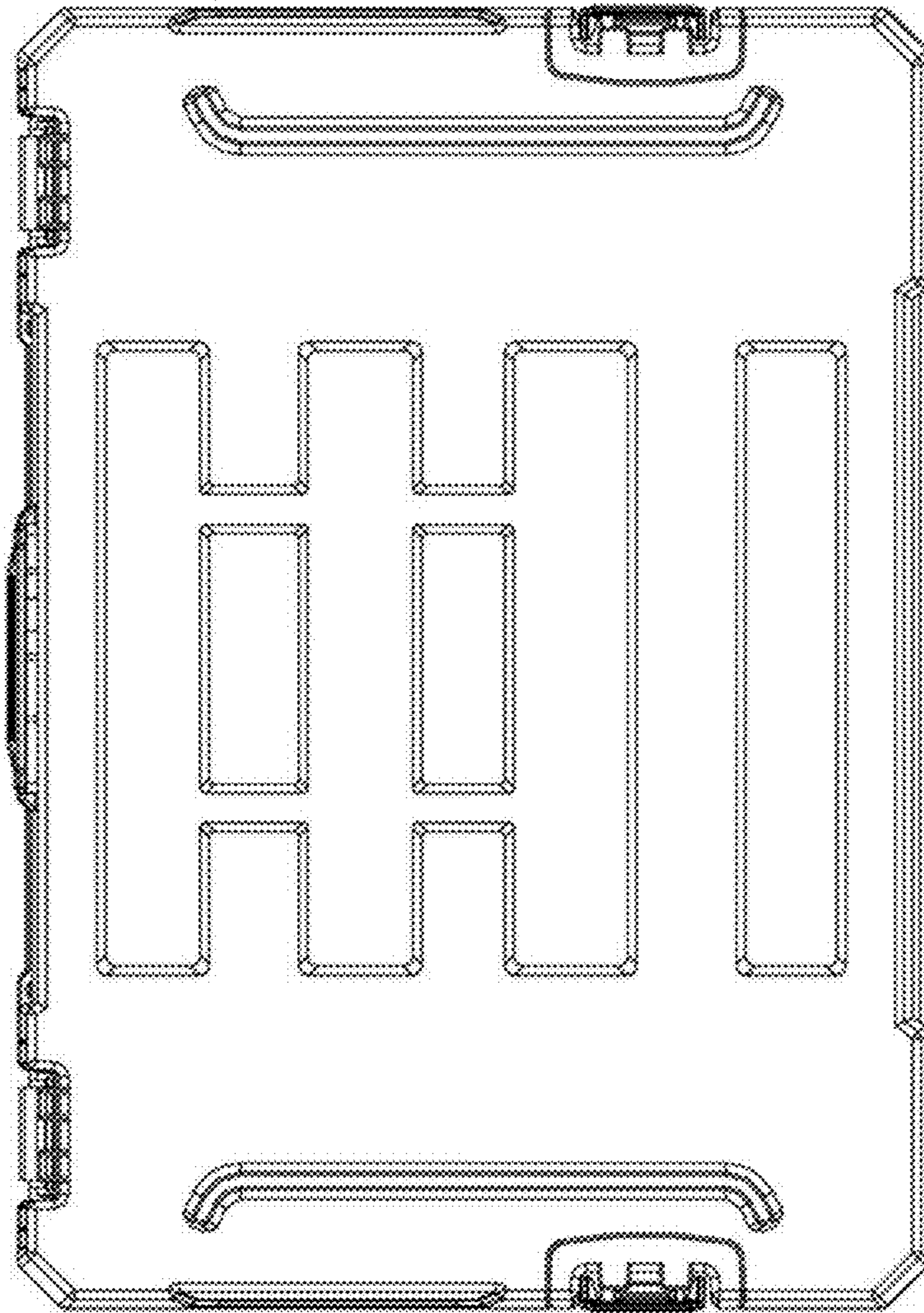

FIG. 27

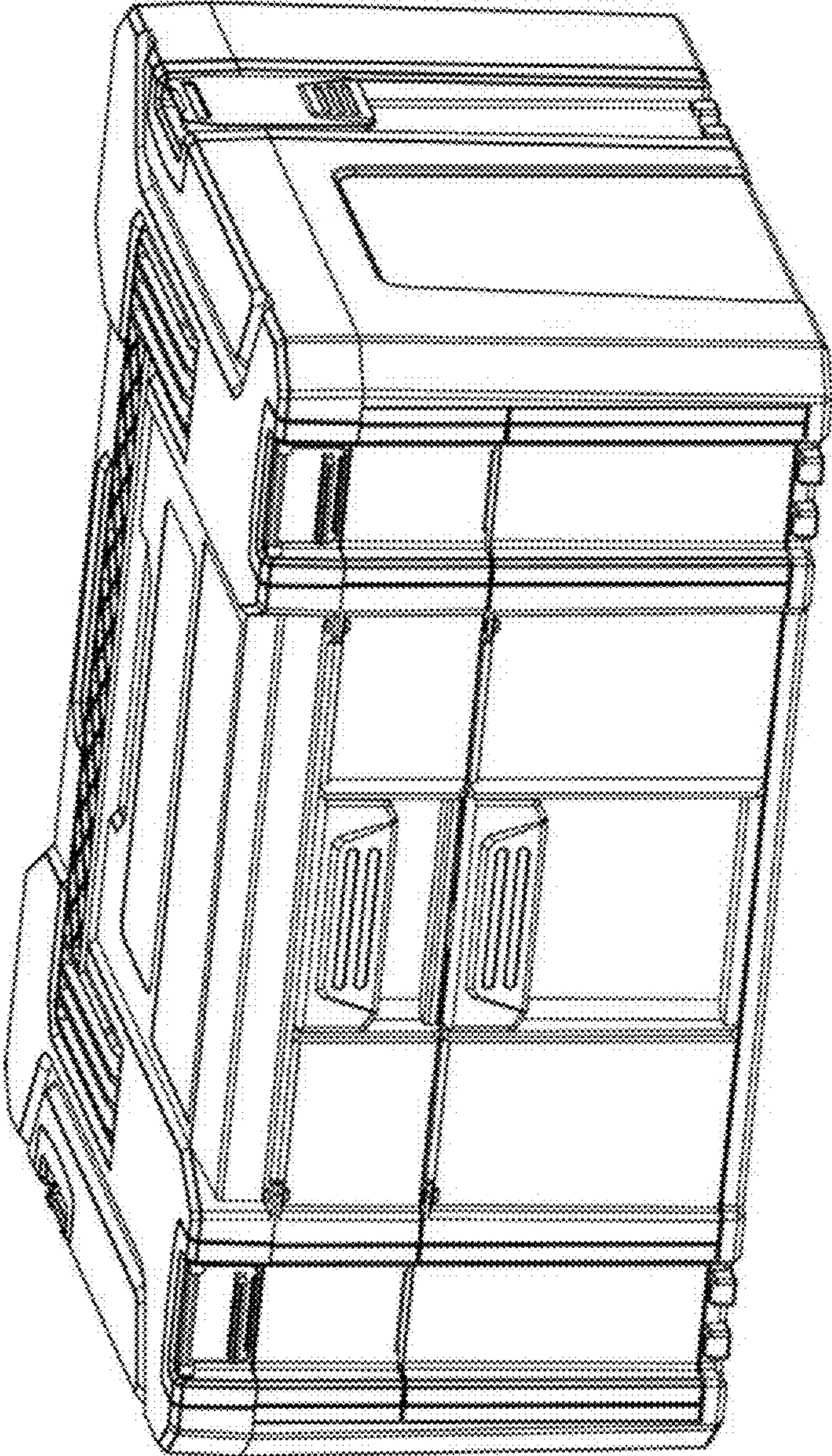

FIG. 28

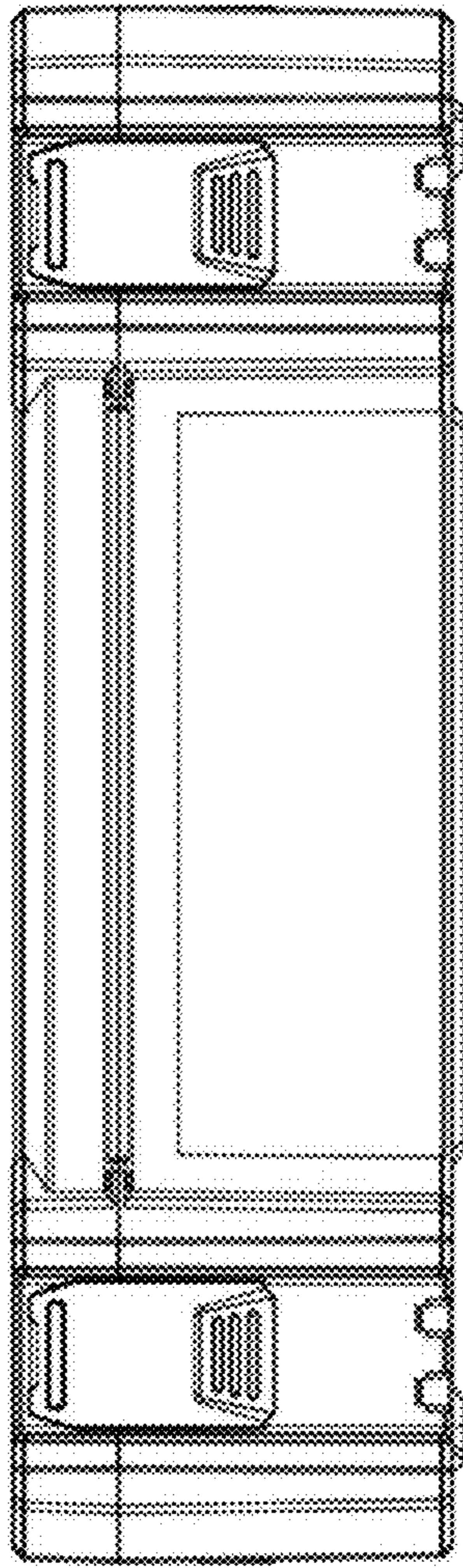

FIG. 29



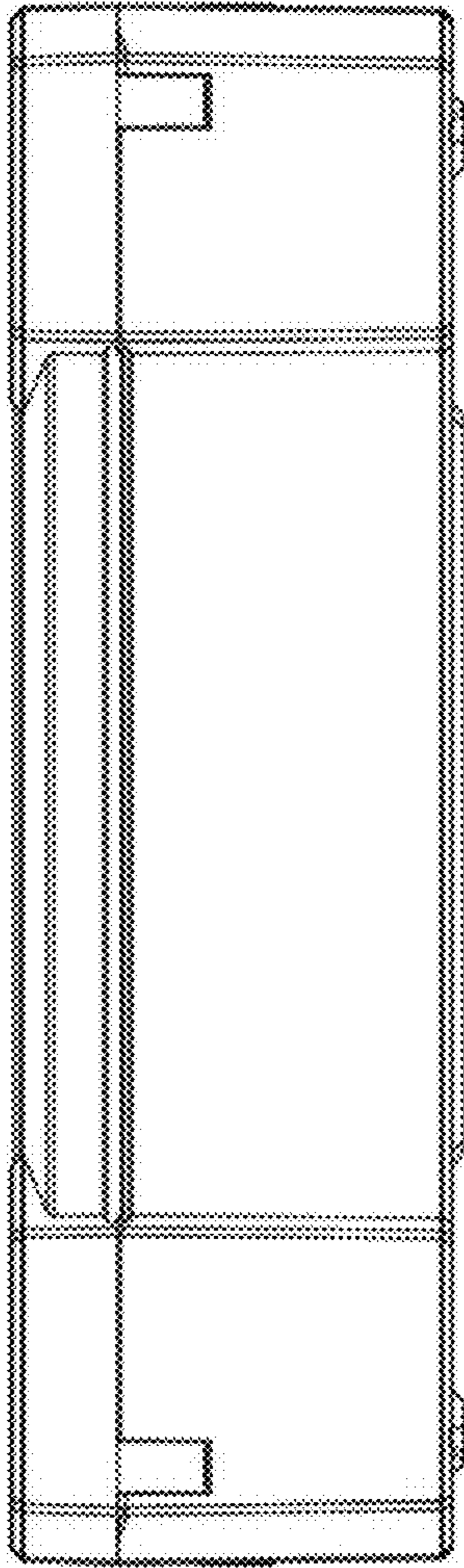

FIG. 30



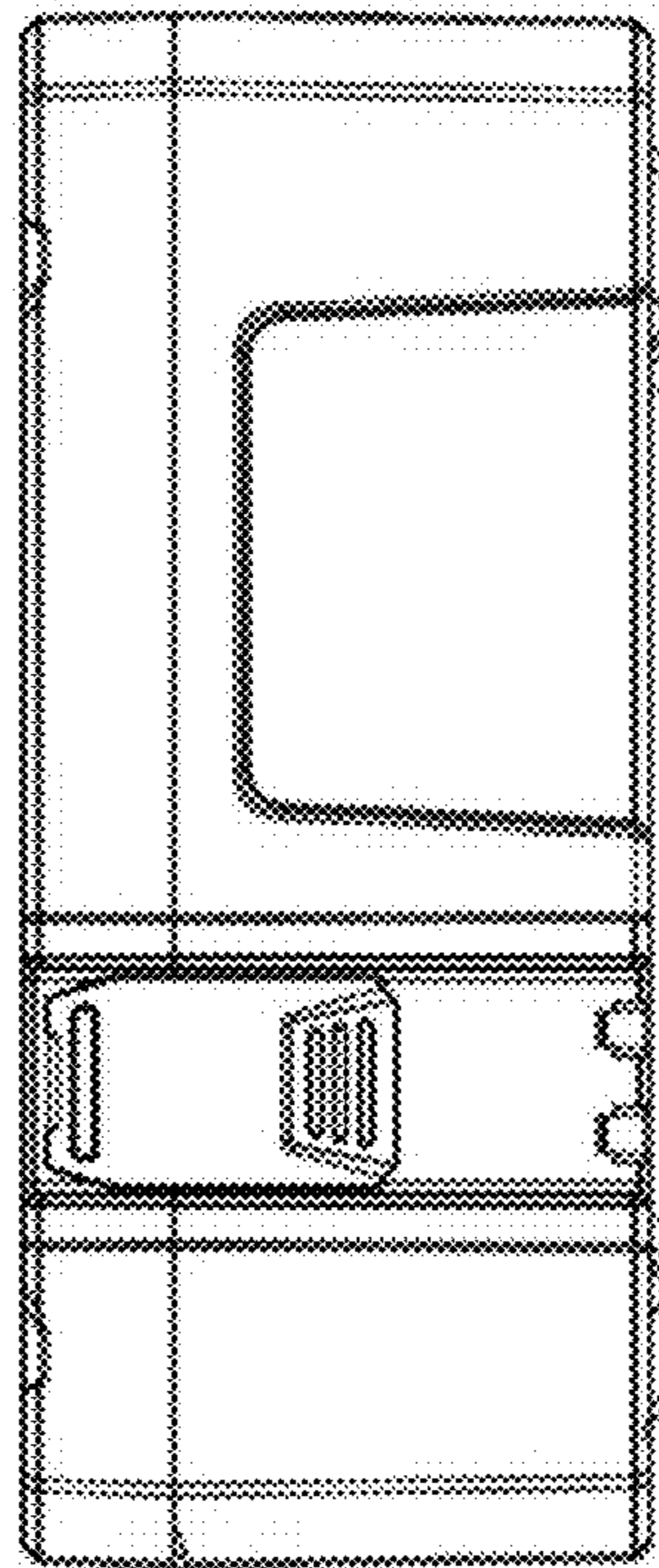

FIG. 31

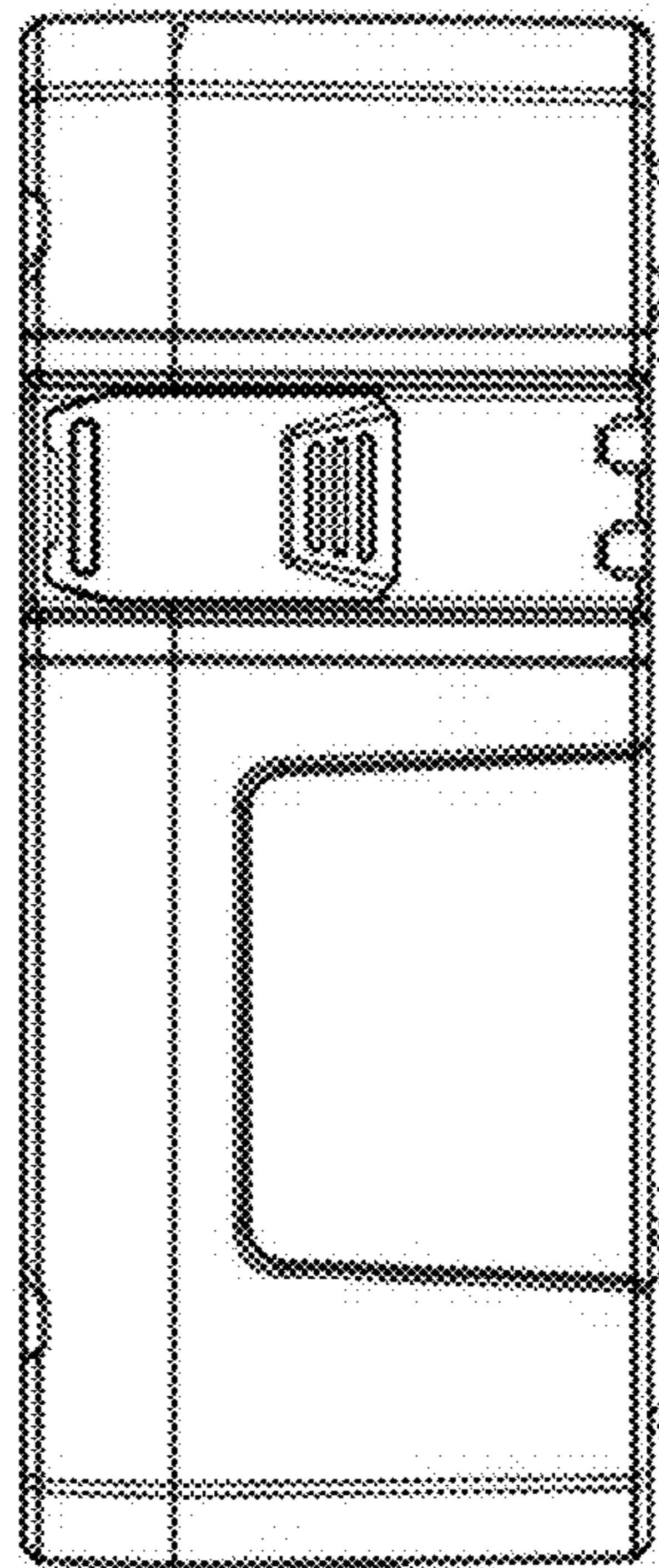

FIG. 32

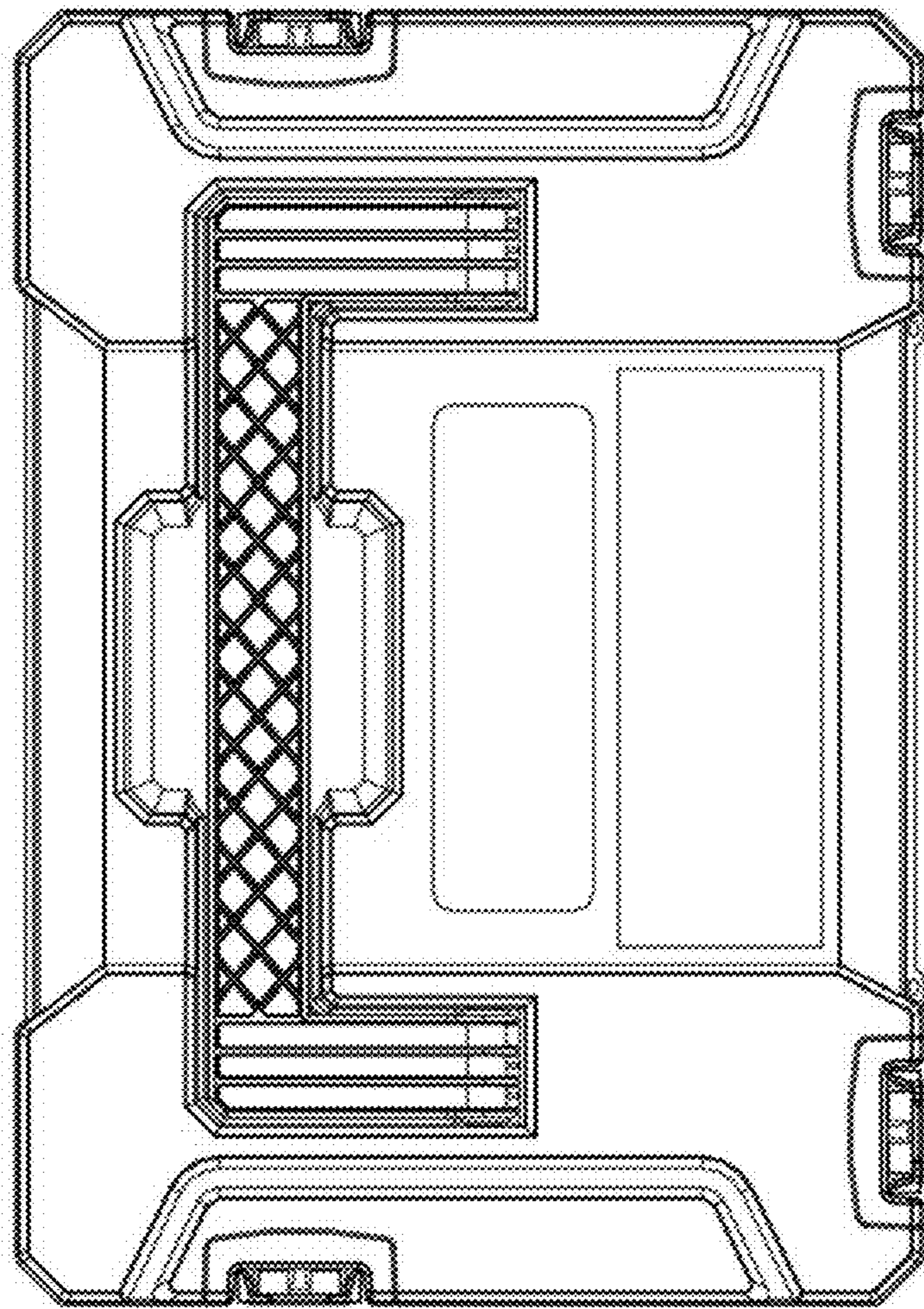

FIG. 33

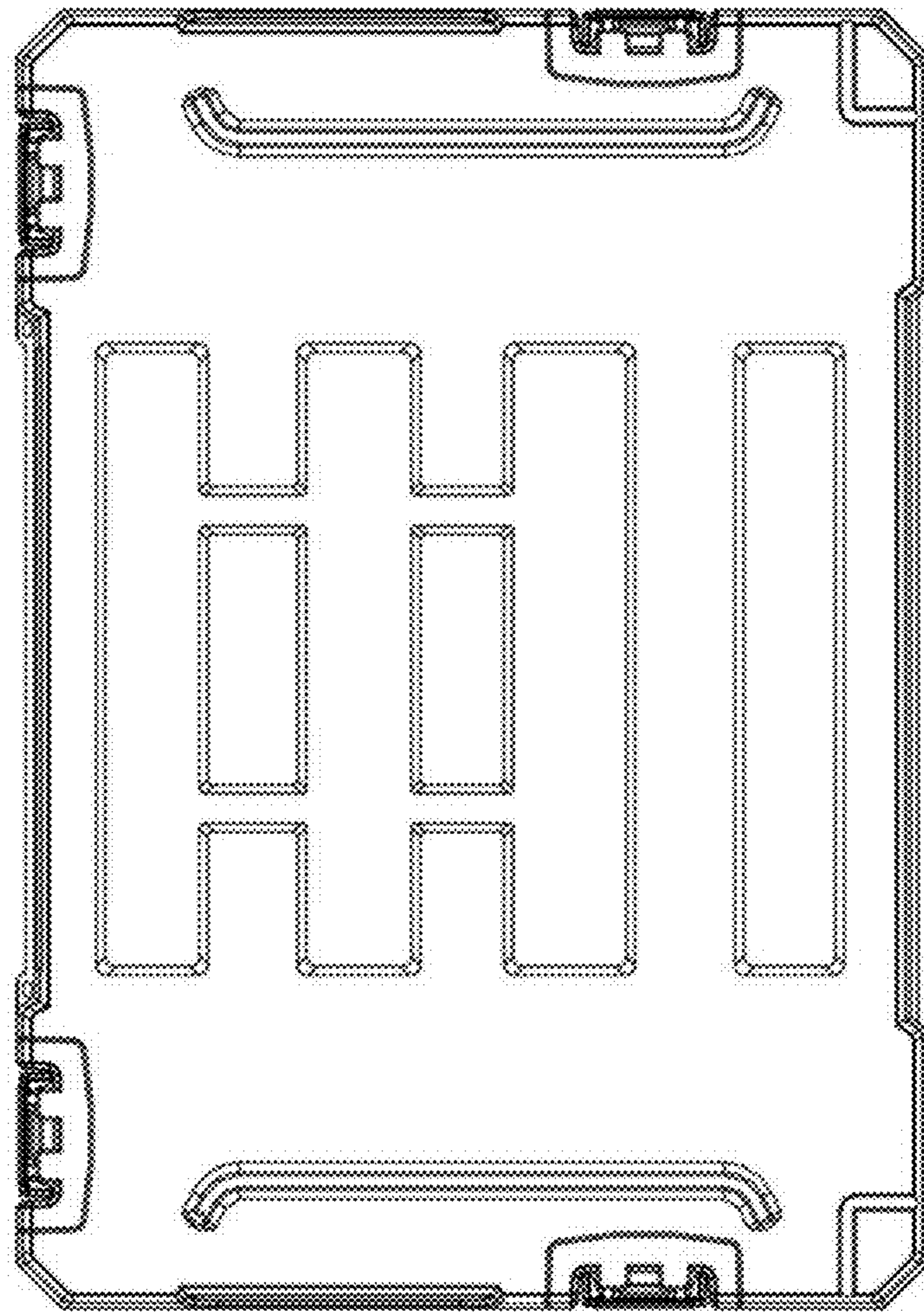

FIG. 34



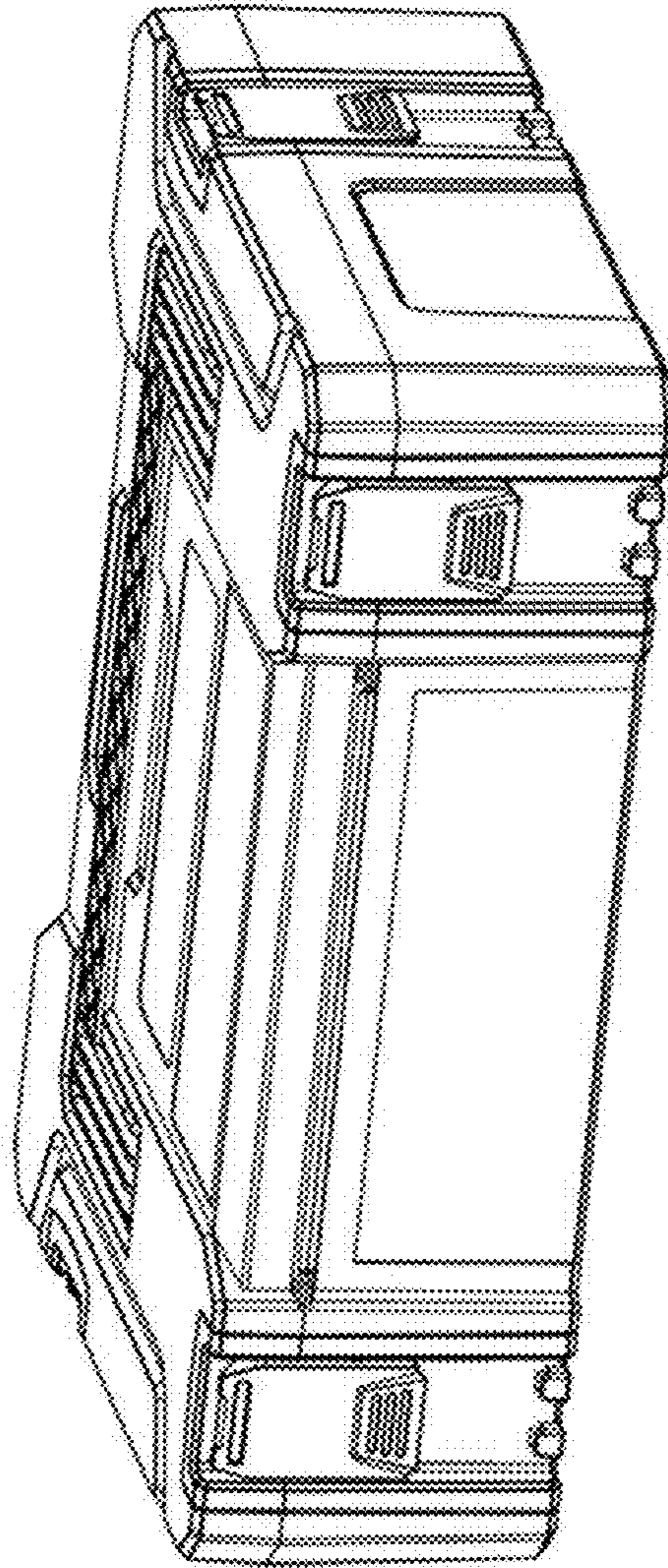

FIG. 35

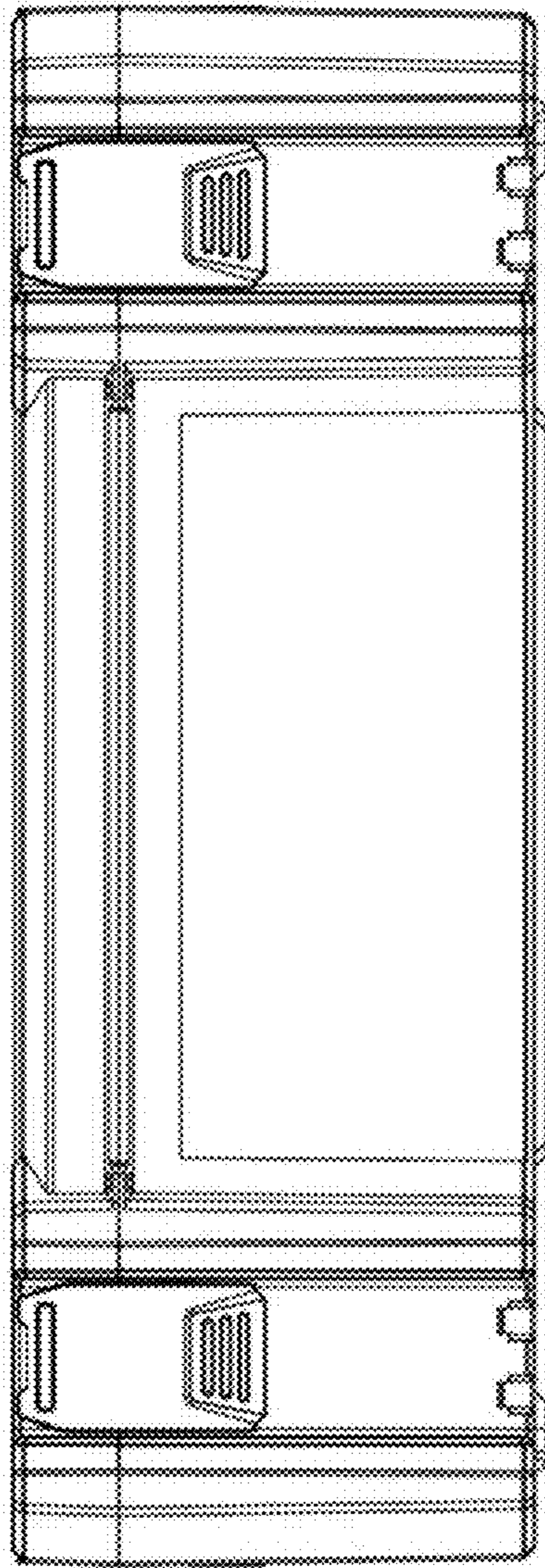

FIG. 36

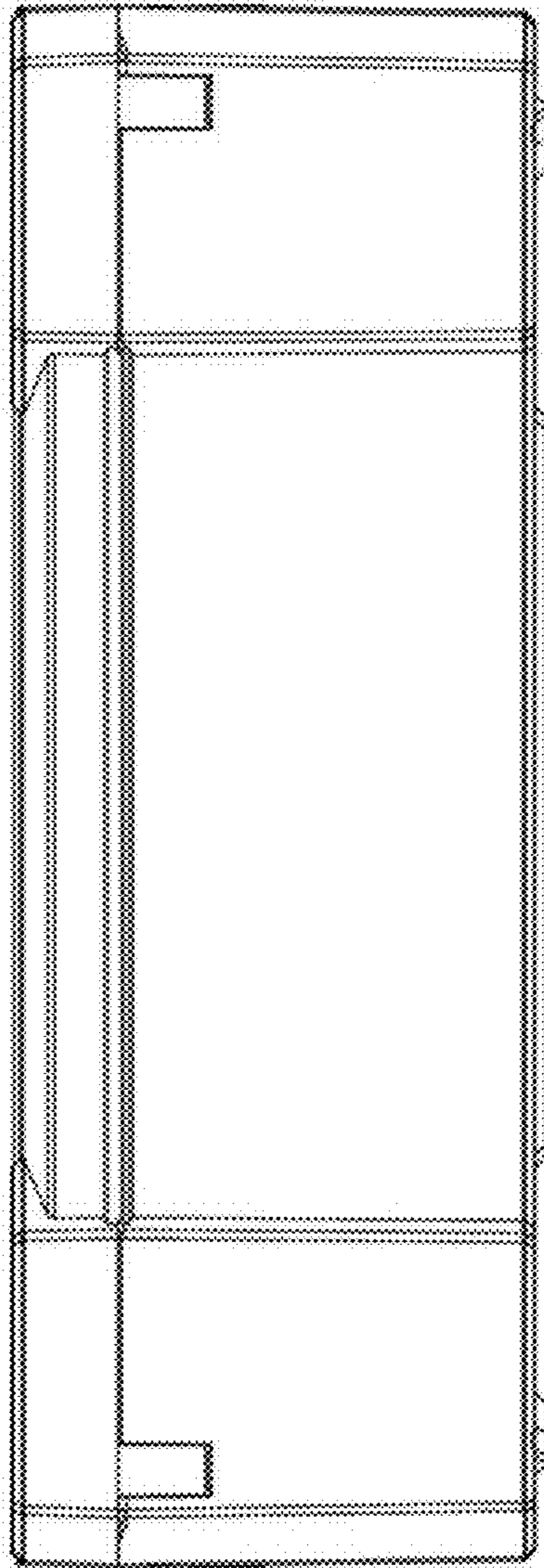

FIG. 37

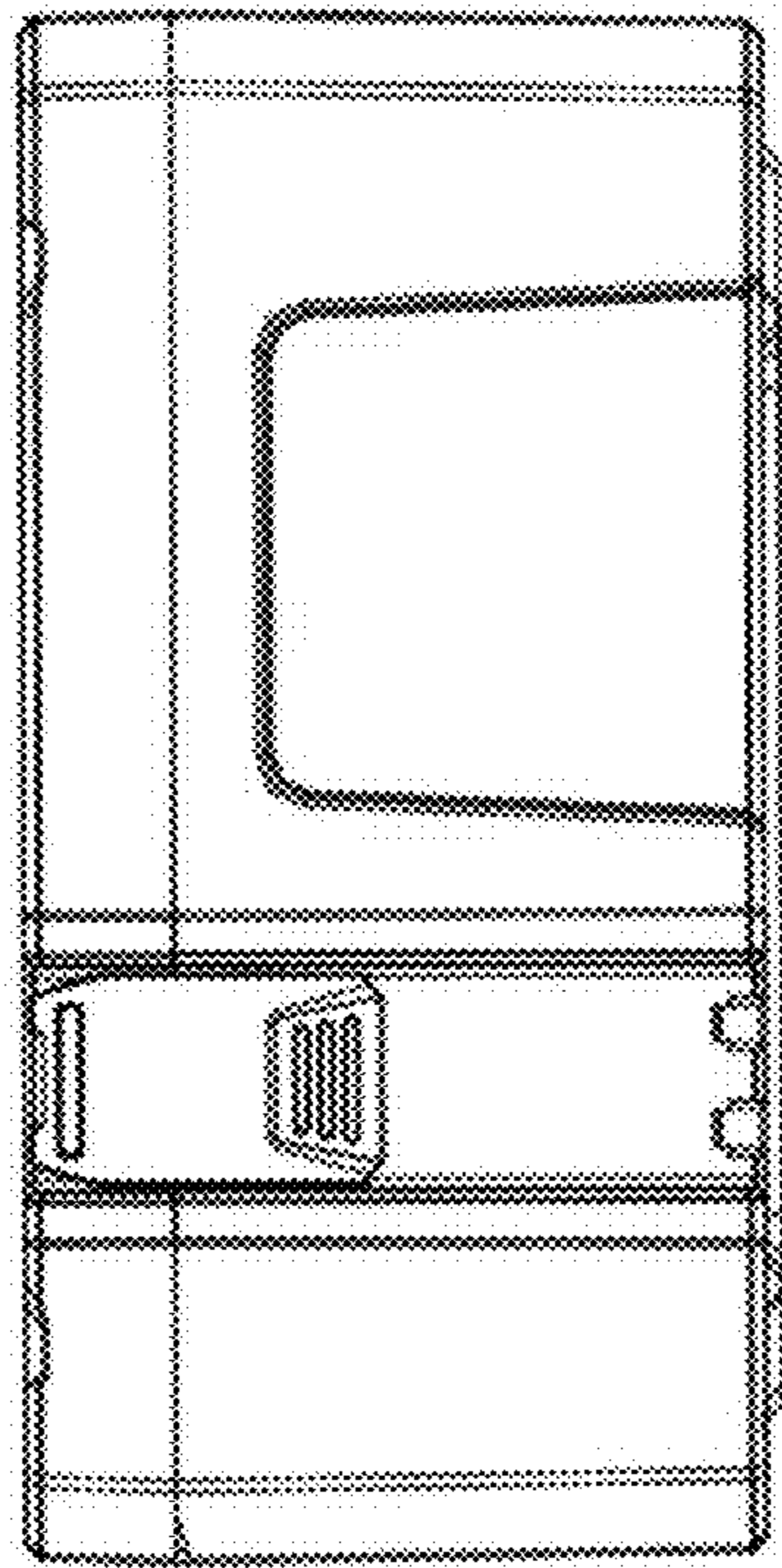

FIG. 38



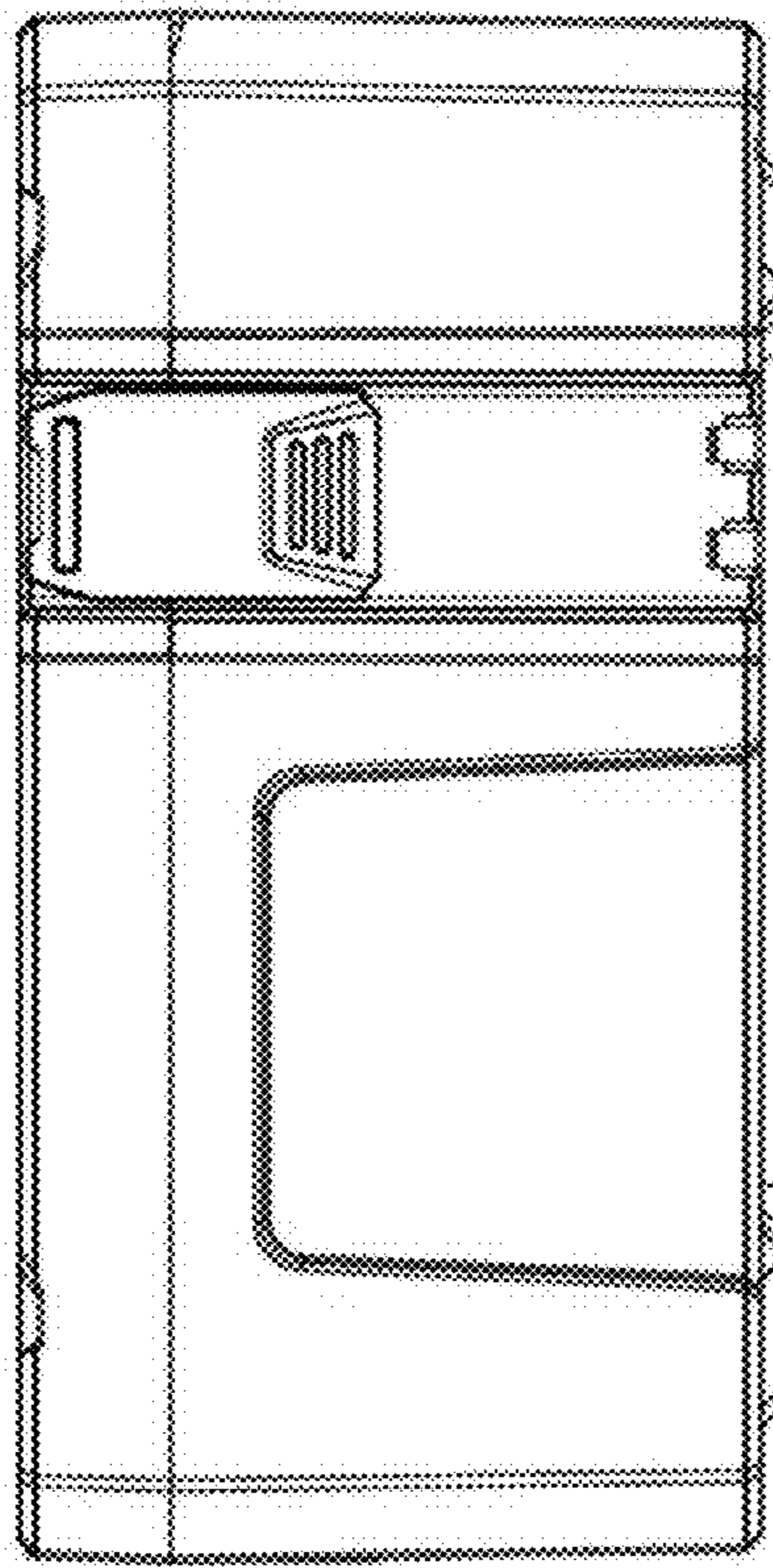

FIG. 39

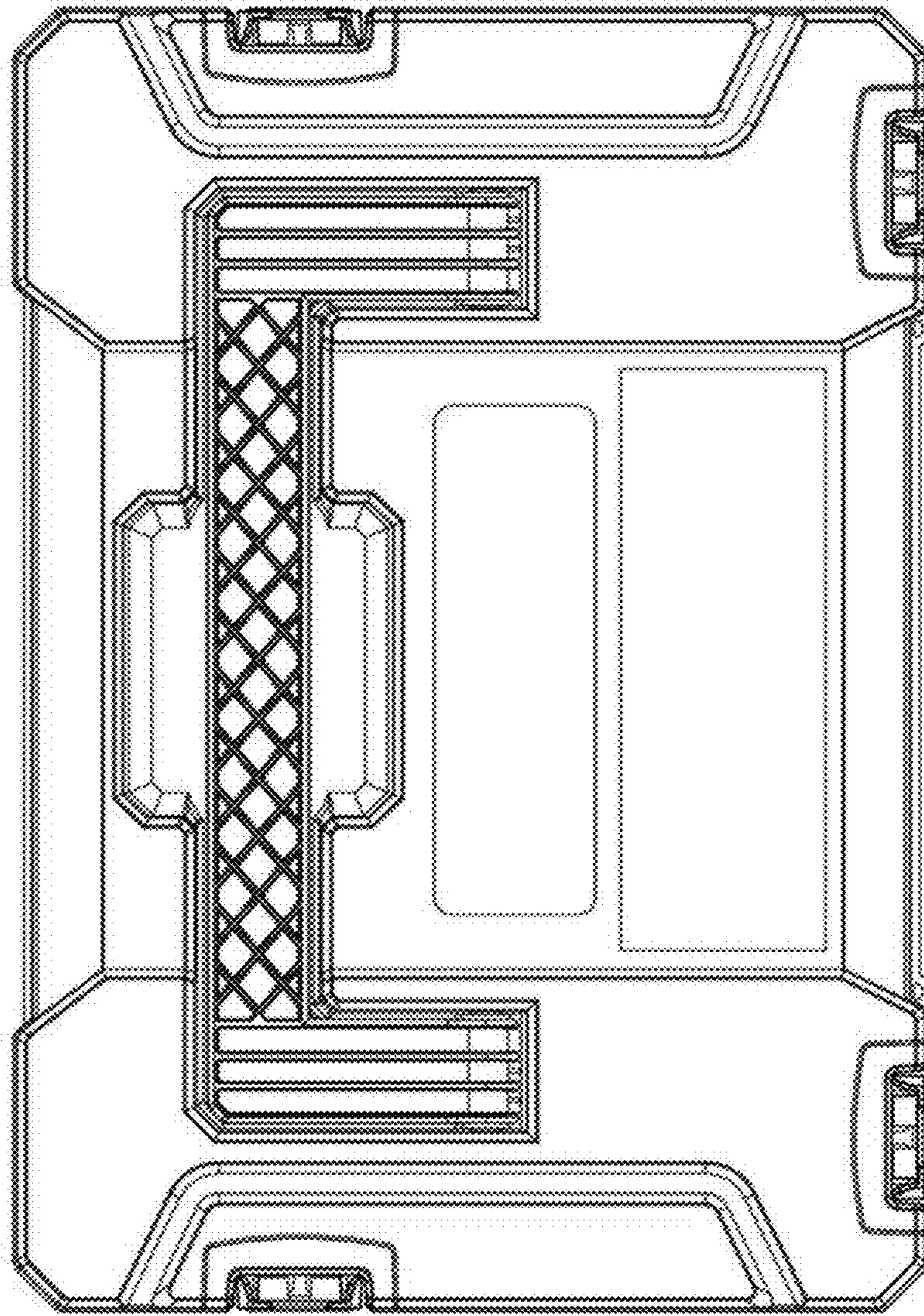

FIG. 40

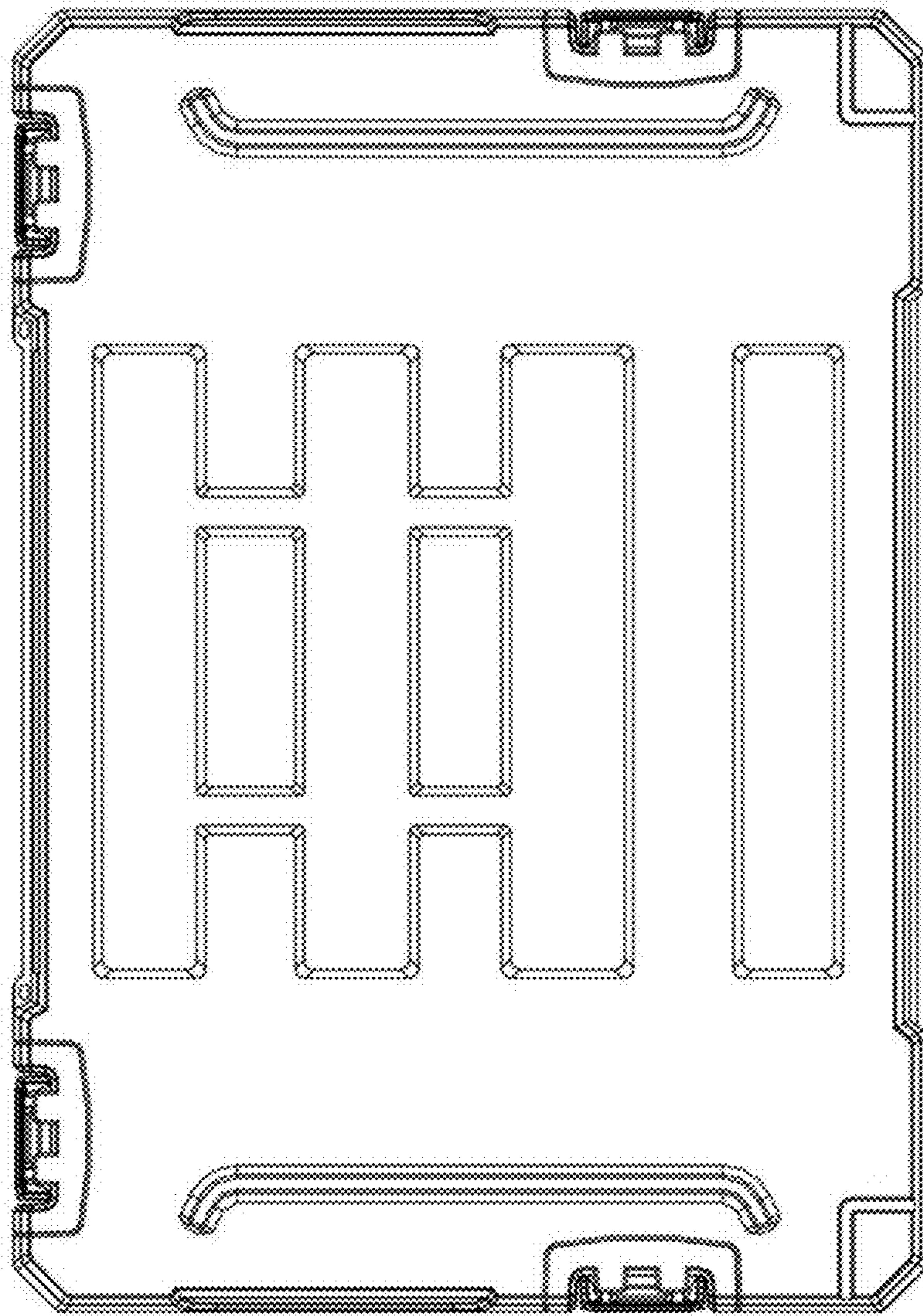

FIG. 41



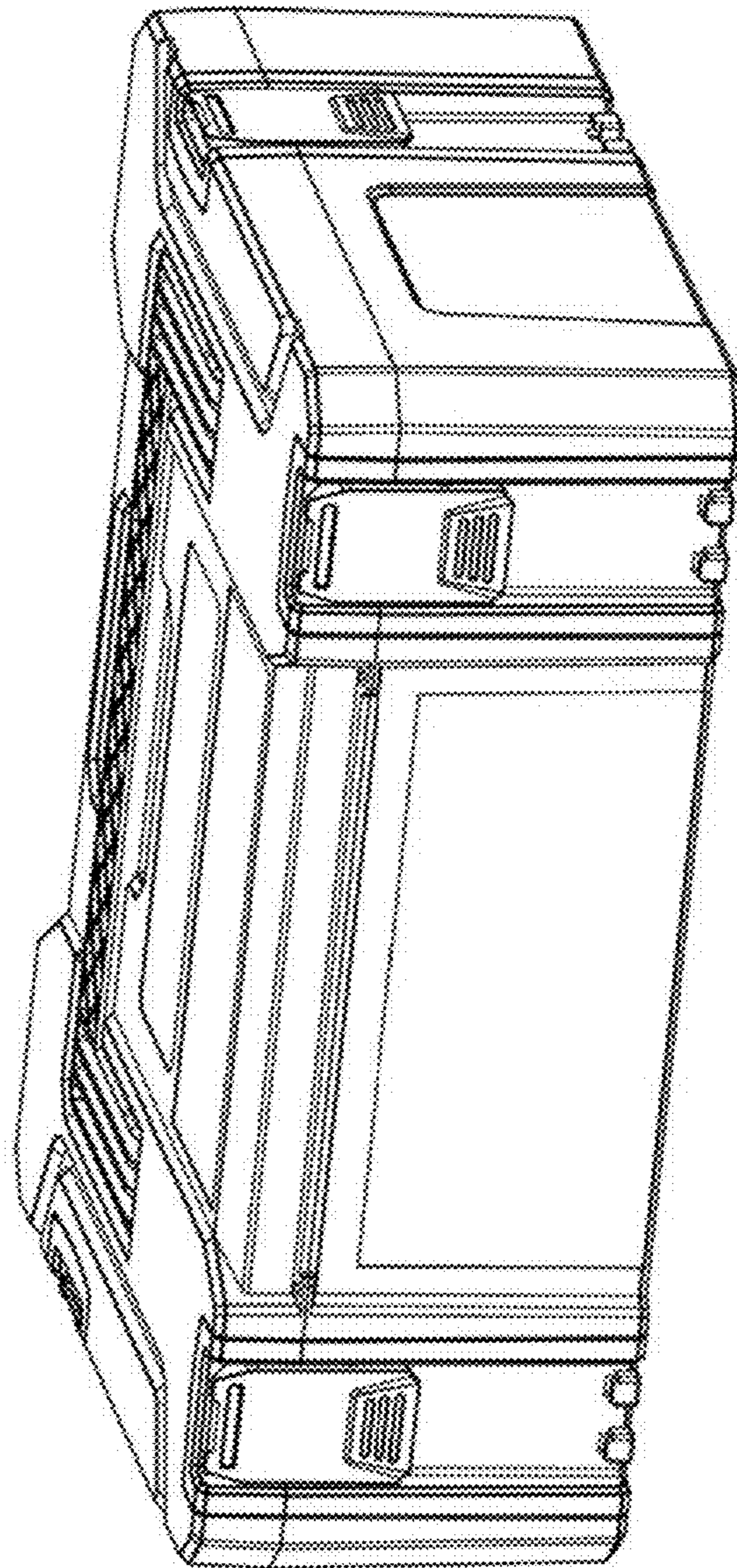

FIG. 42



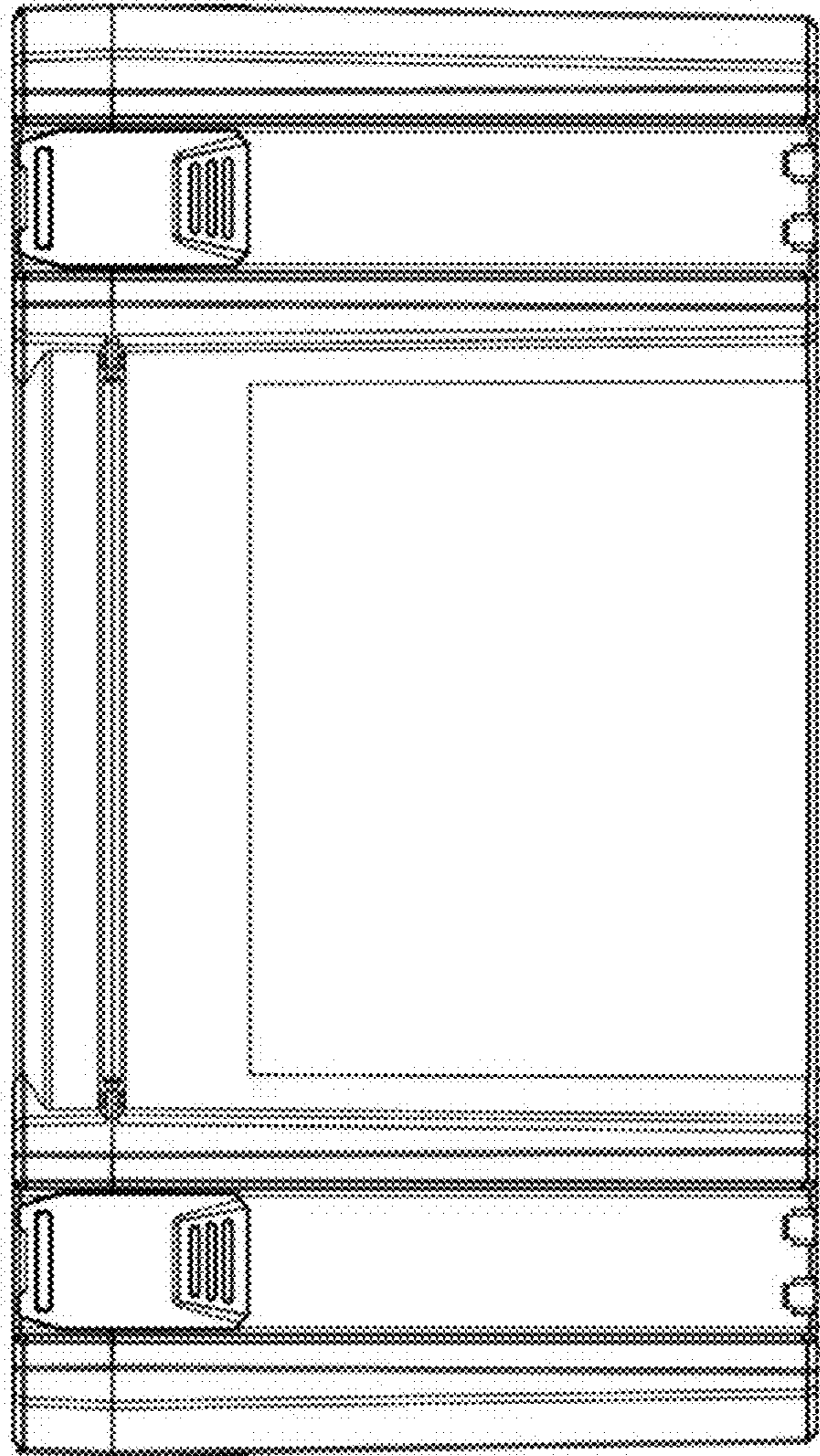

FIG. 43

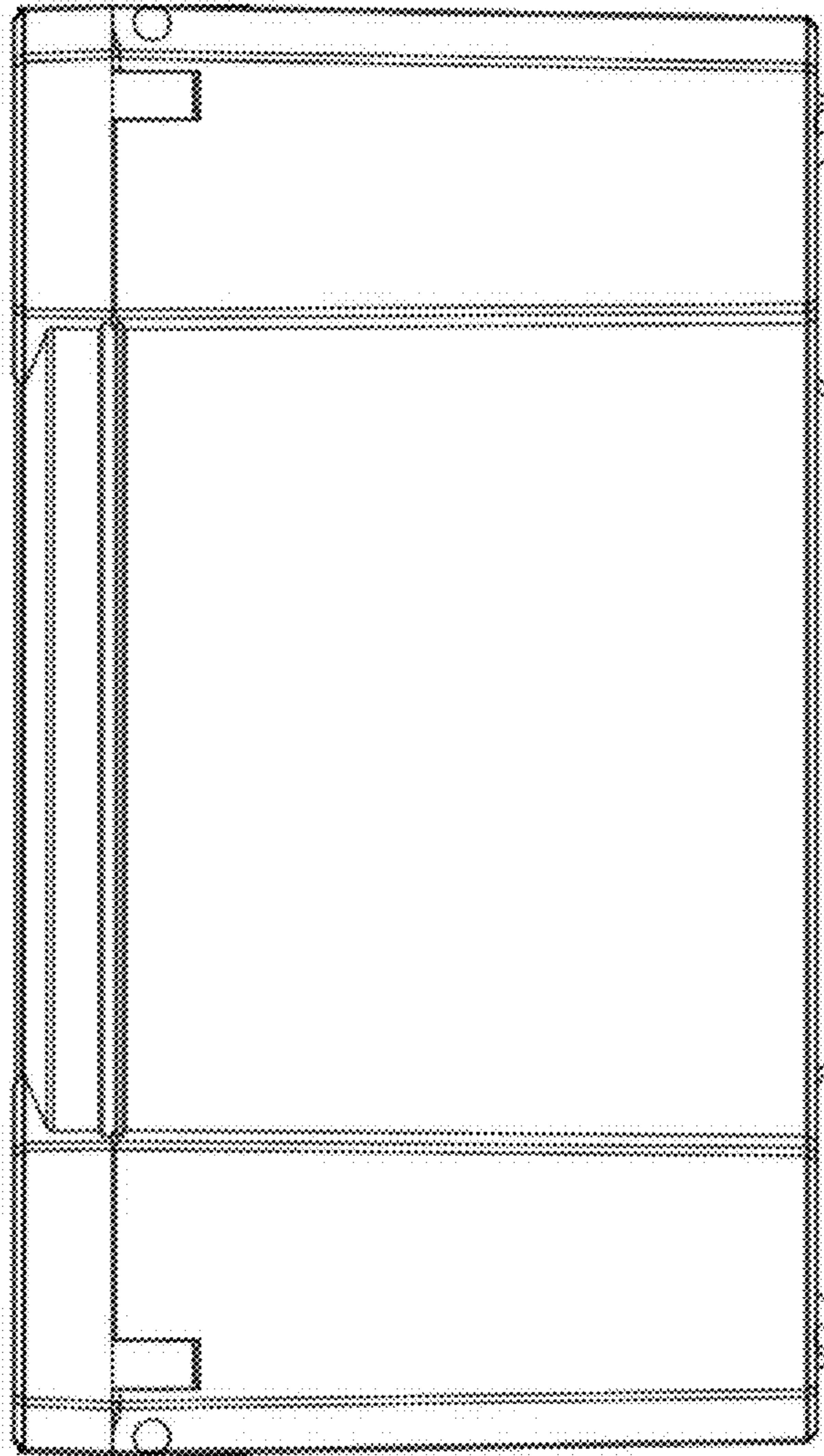

FIG. 44

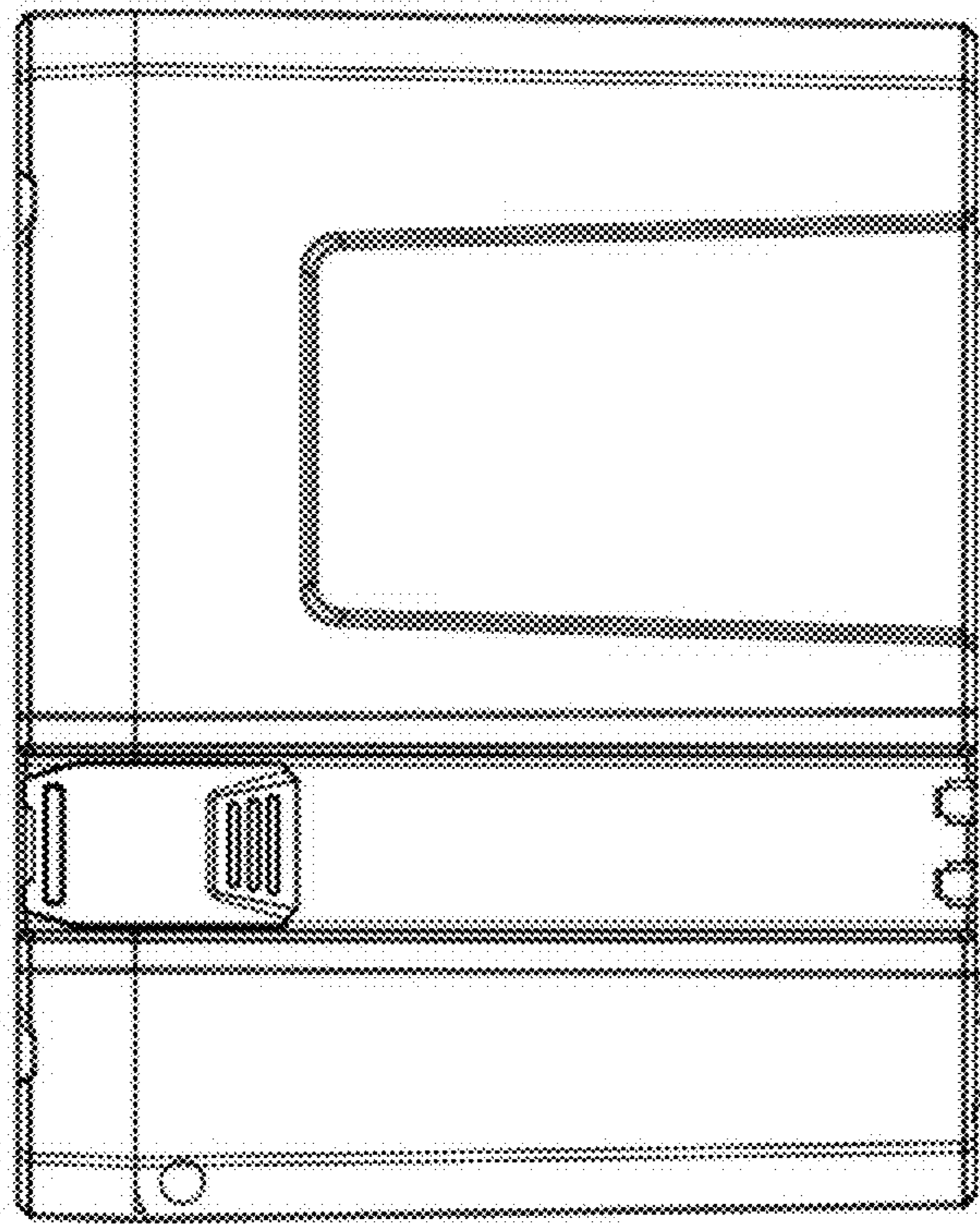

FIG. 45

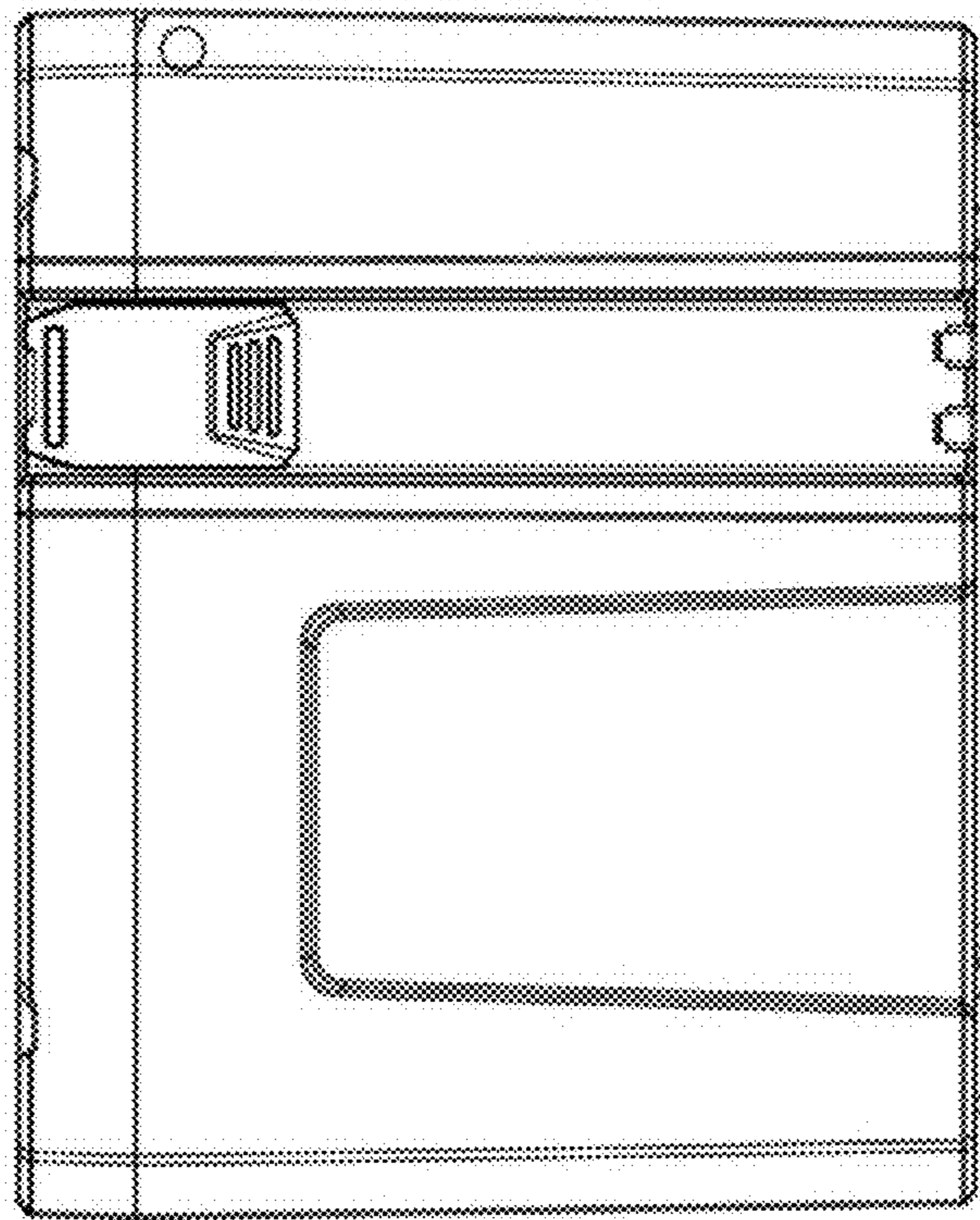

FIG. 46



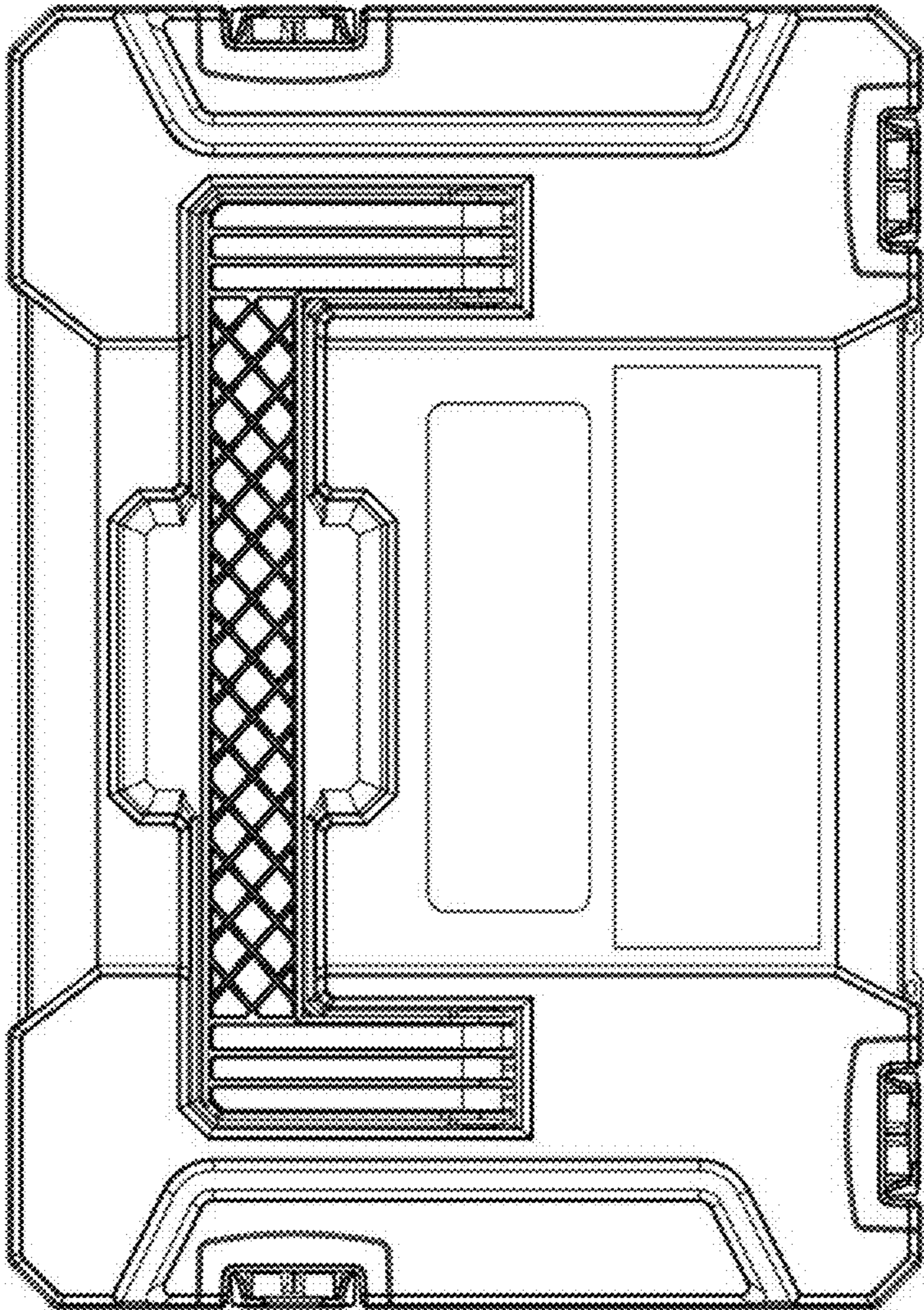

FIG. 47

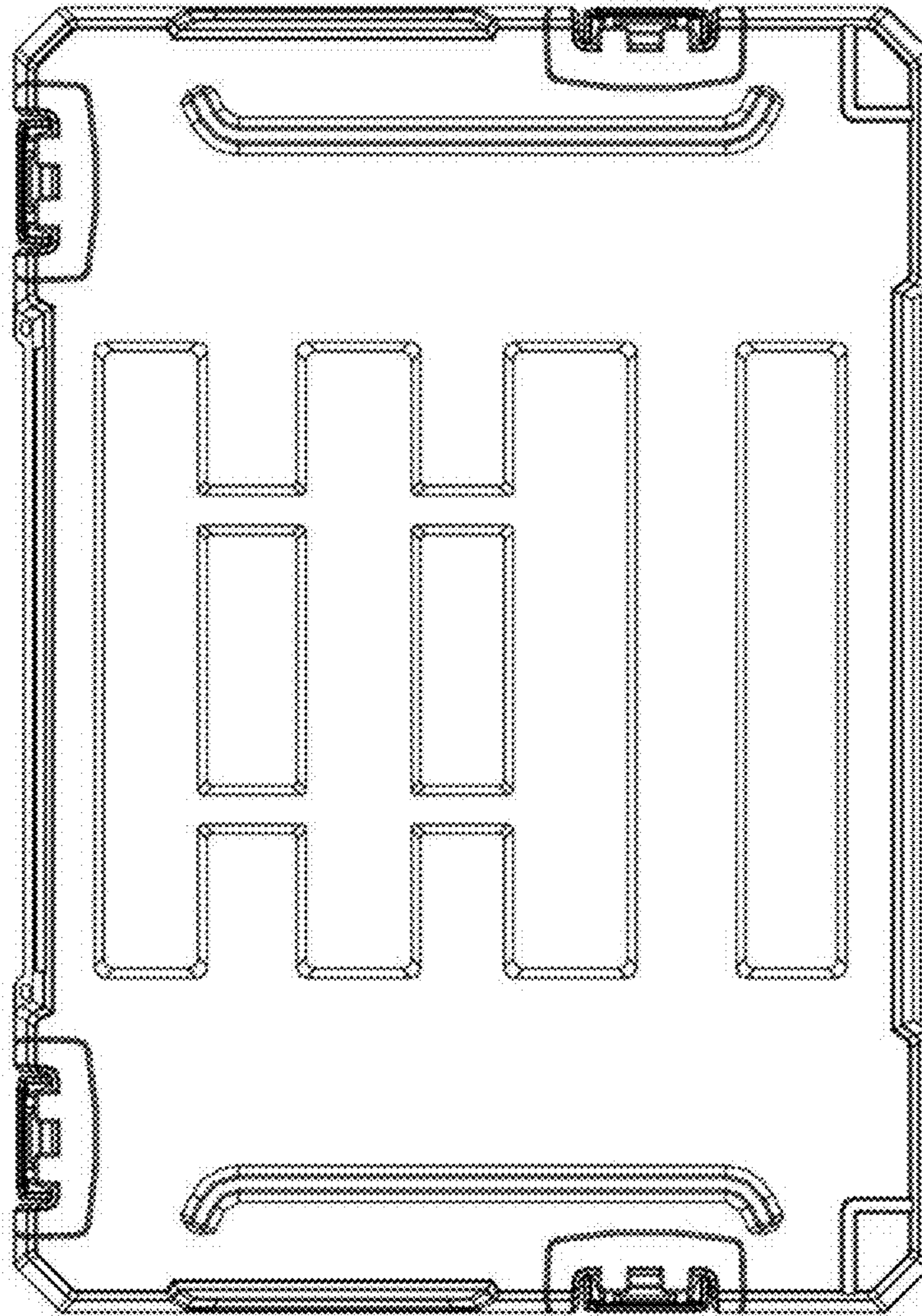

FIG. 48



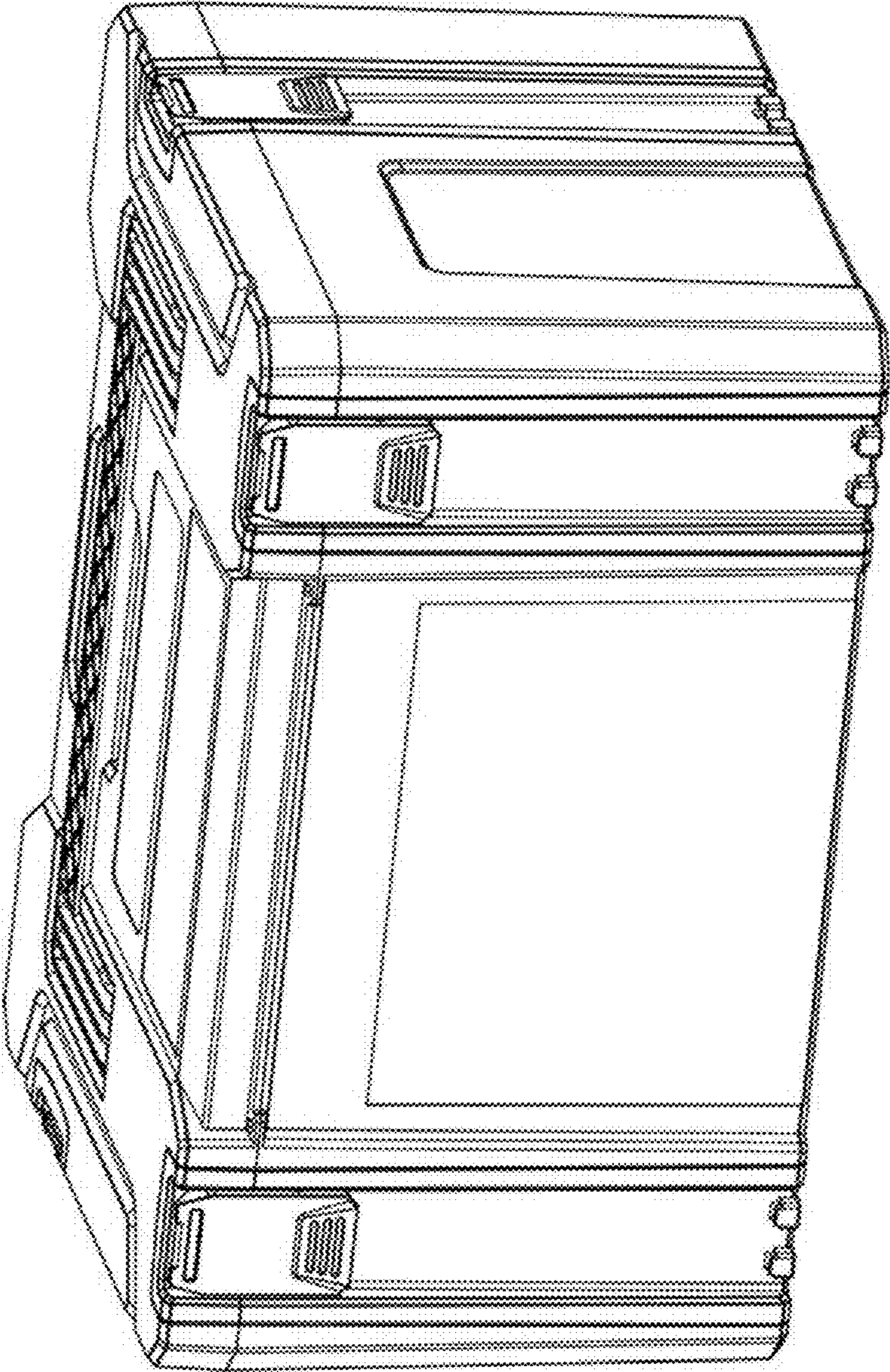

FIG. 49

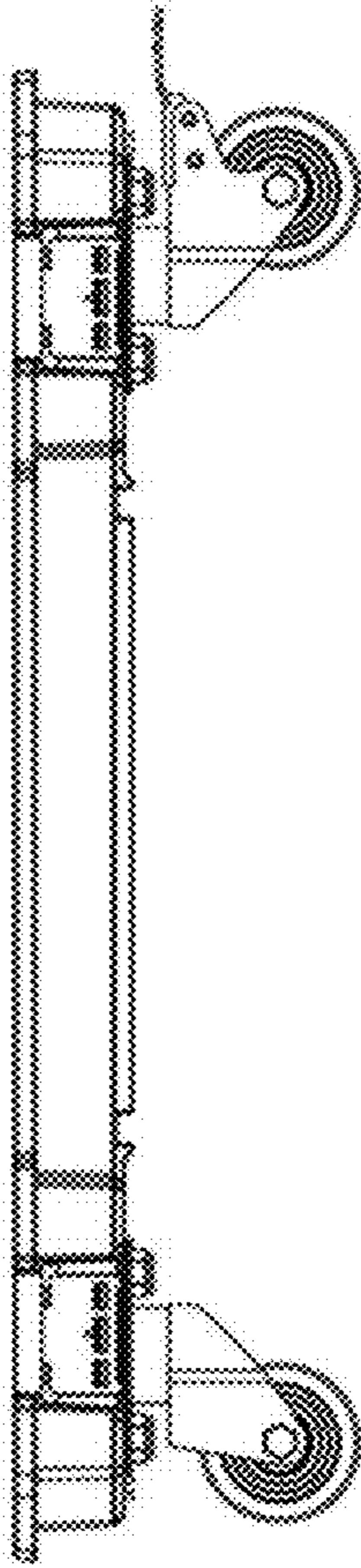

FIG. 50





FIG. 51

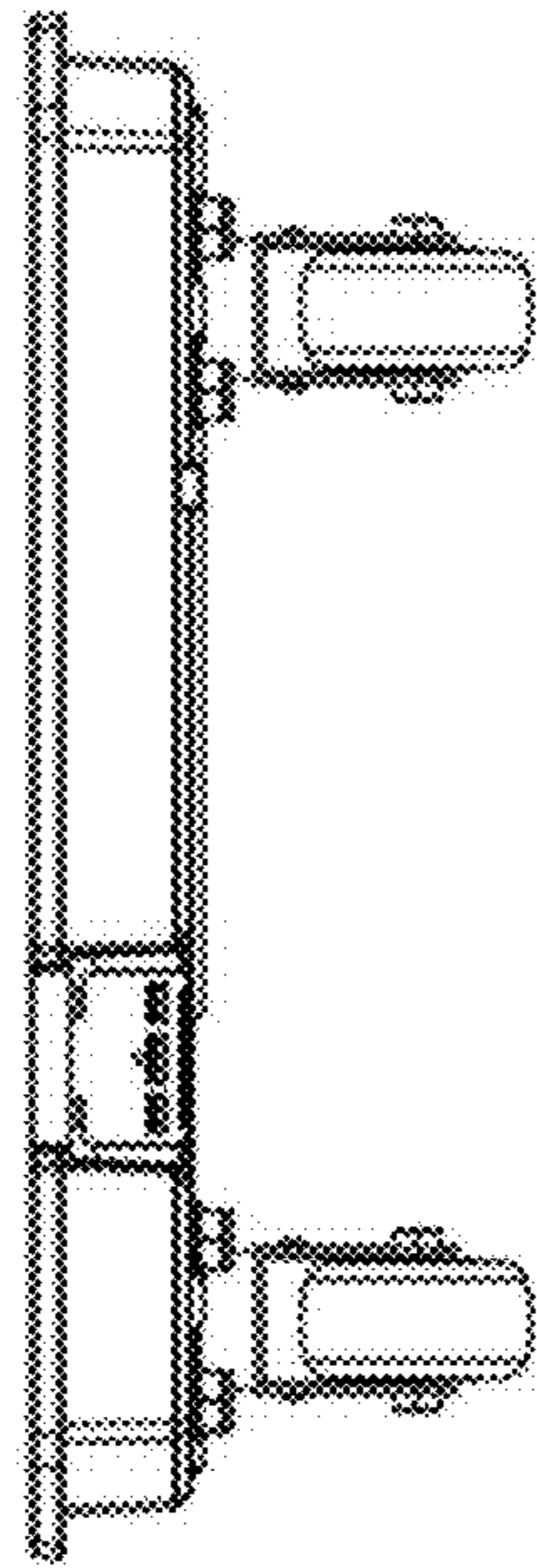

FIG. 52

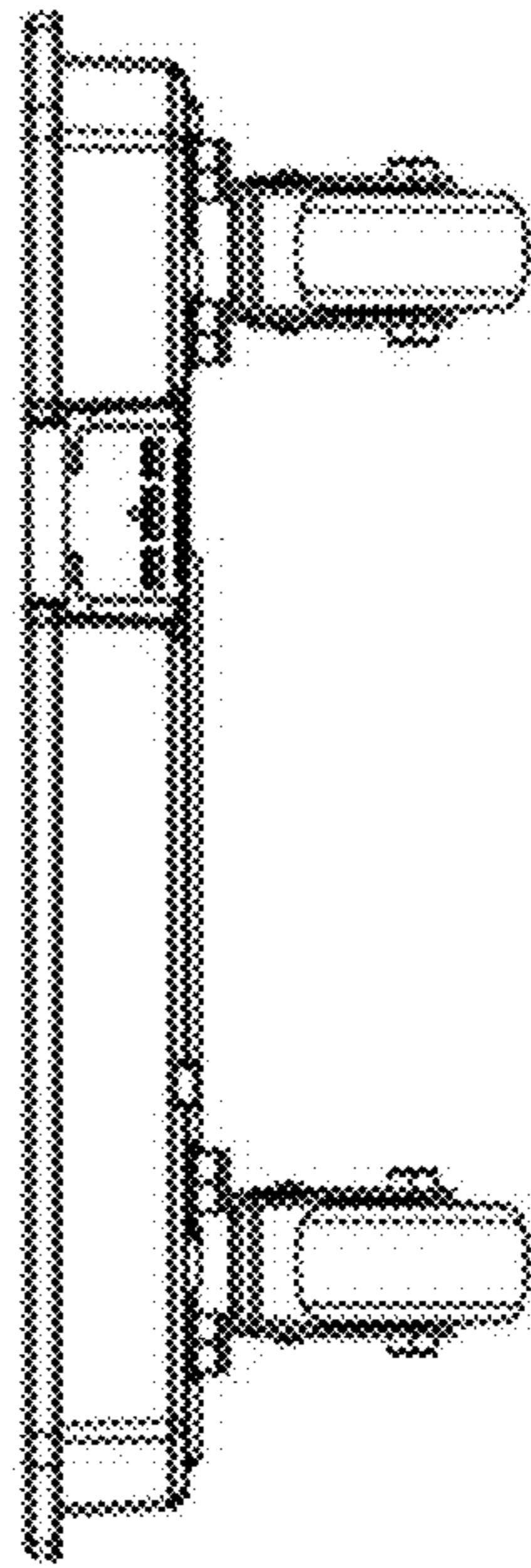

FIG. 53

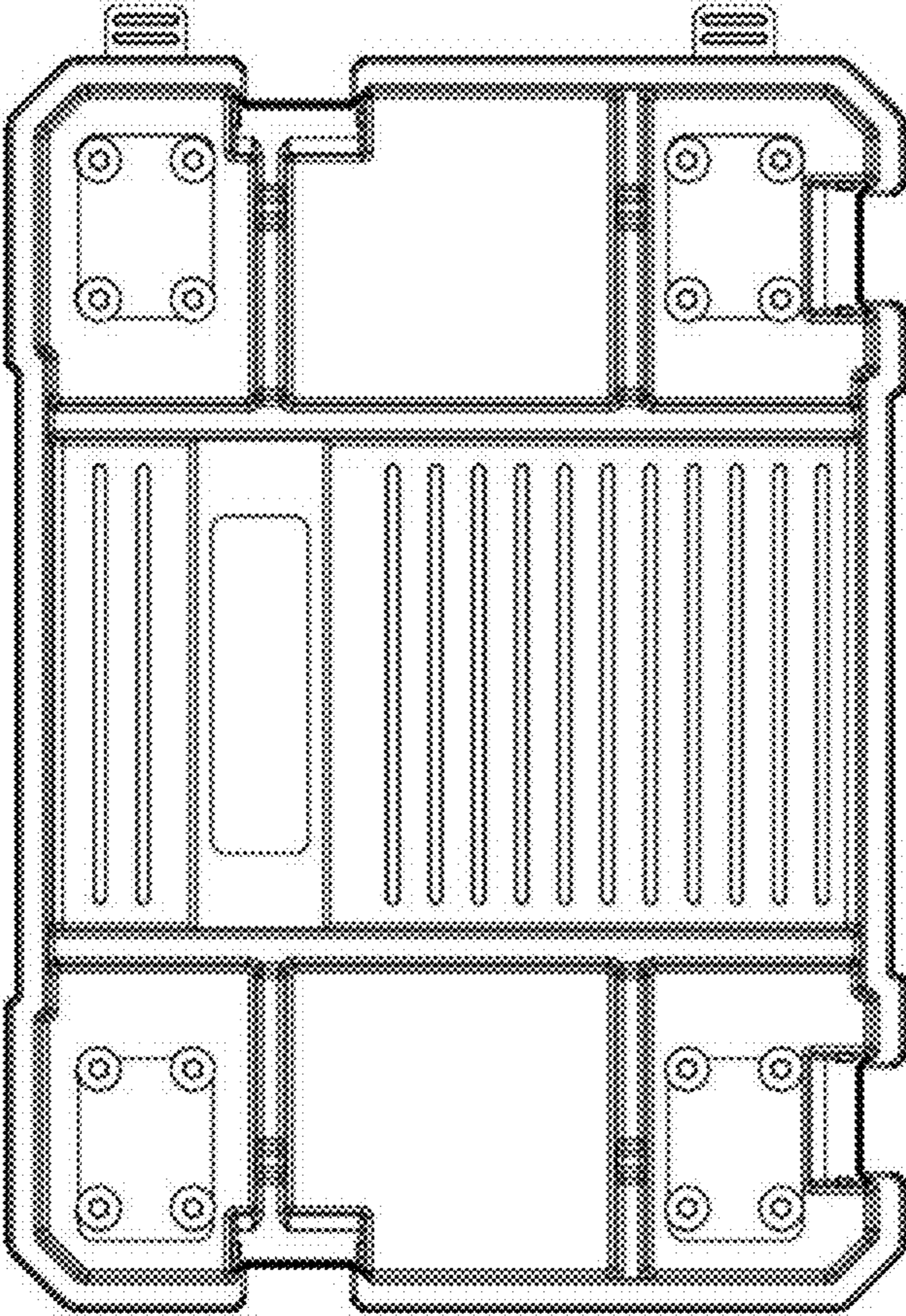

FIG. 54



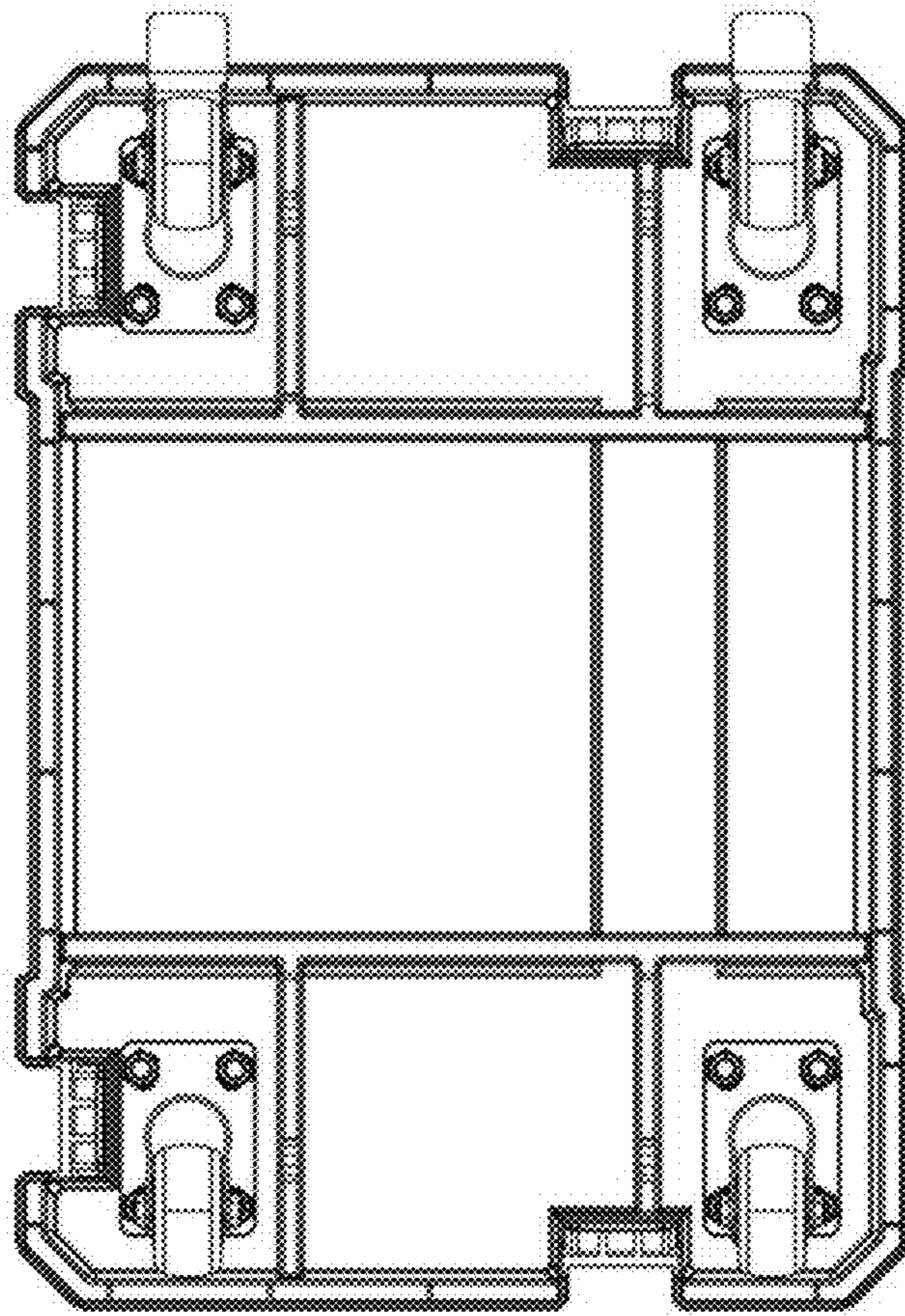

FIG. 55

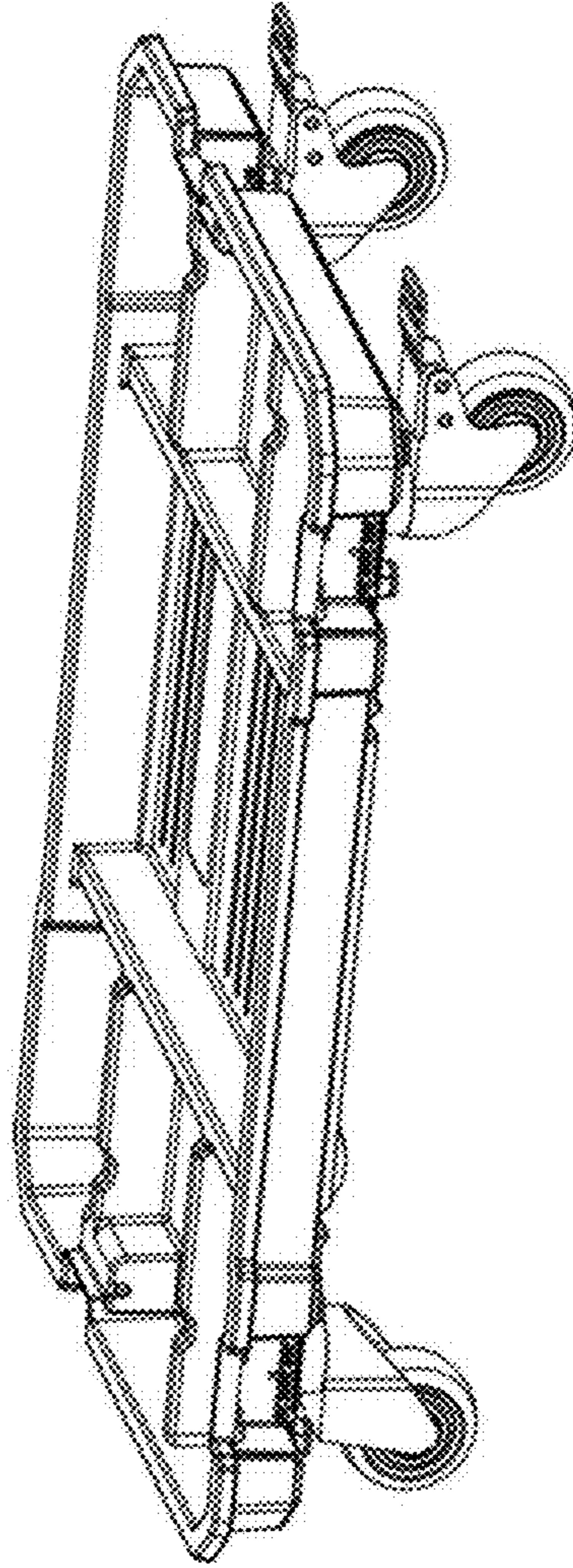

FIG. 56



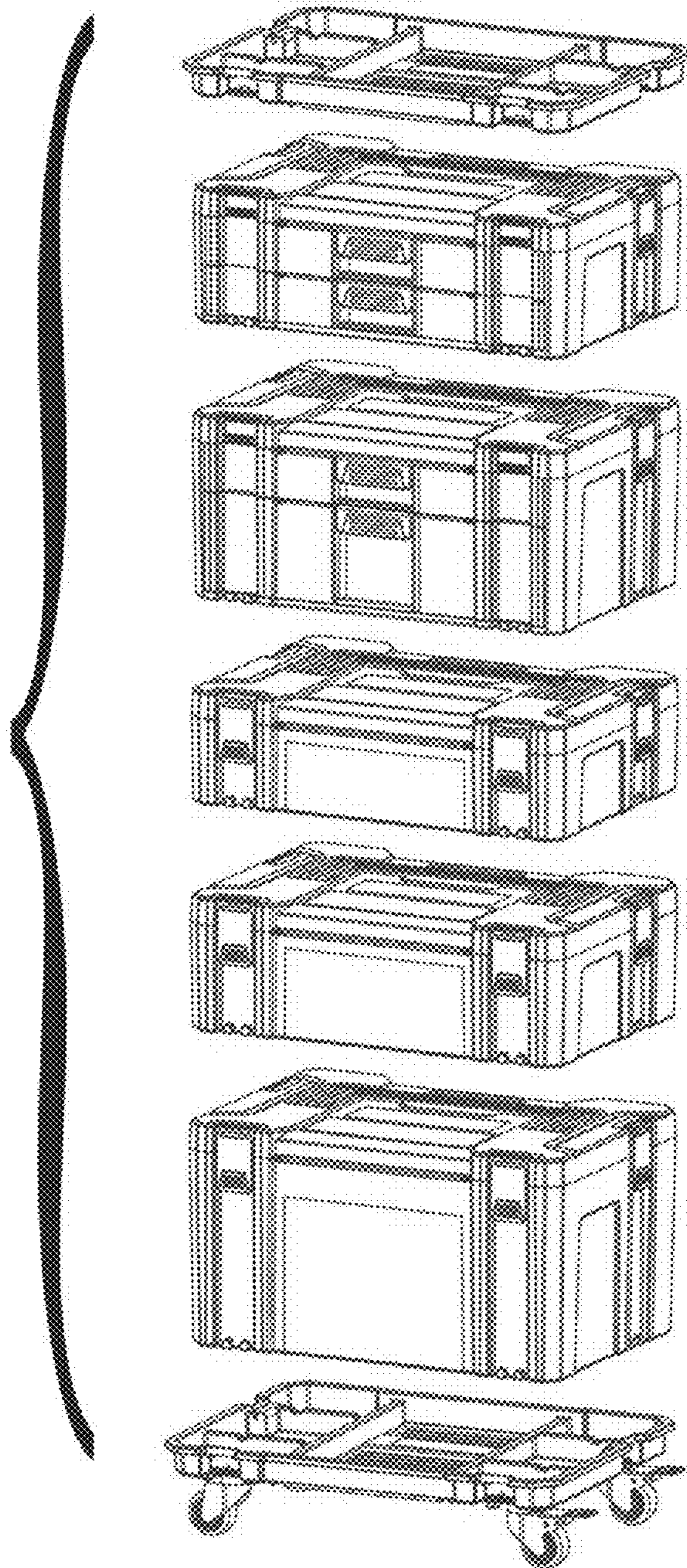

FIG. 57