



US00D788499S

(12) **United States Design Patent** (10) **Patent No.:** **US D788,499 S**
Anderson et al. (45) **Date of Patent:** **** Jun. 6, 2017**

(54) **ENCLOSURE**

(71) Applicant: **Suncast Technologies, LLC**, Palm Beach Gardens, FL (US)

(72) Inventors: **Torrence Anderson**, Overland Park, KS (US); **Michael Thuma**, La Grange, IL (US); **Brian J Russell**, North Aurora, IL (US); **Michael R Vogler**, Oswego, IL (US)

(73) Assignee: **Suncast Technologies, LLC**, Palm Beach Gardens, FL (US)

(**) Term: **14 Years**

(21) Appl. No.: **29/522,668**

(22) Filed: **Apr. 1, 2015**

(51) **LOC (10) Cl.** **06-04**

(52) **U.S. Cl.**
USPC **D6/667**

(58) **Field of Classification Search**
USPC D3/272, 273, 277, 294; D6/657, D6/660-667, 671, 671.1
CPC A47B 17/04; A47B 47/03; A47B 67/00; A47B 81/06; A47B 83/00; A47C 7/62; A47F 3/00; A47F 3/005; A47F 5/0807
See application file for complete search history.

(56) **References Cited**

U.S. PATENT DOCUMENTS

D389,646 S * 1/1998 Sankey D3/294
D421,181 S * 2/2000 Tisbo D3/273

D429,418 S *	8/2000	Tisbo	D25/16
D444,626 S *	7/2001	Anderson	D3/273
D493,302 S *	7/2004	Sabo	D6/667
D600,473 S *	9/2009	Lowsky	D6/667
D658,374 S *	5/2012	Anderson	D3/273
D662,709 S *	7/2012	Uffner	D3/277
D715,048 S *	10/2014	Donnelly	D3/273
D715,049 S *	10/2014	Fischer, Jr.	D3/277
D723,803 S *	3/2015	Thuma	D3/277
2007/0001561 A1 *	1/2007	Sabo	A47B 67/00 312/316
2012/0199600 A1 *	8/2012	Anderson	A47C 7/62 220/810

* cited by examiner

Primary Examiner — Ricky Pham

(74) *Attorney, Agent, or Firm* — McHale & Slavin, P.A.

(57) **CLAIM**

The ornamental design for an enclosure, as shown and described.

DESCRIPTION

FIG. 1 is a top left isometric view of the enclosure of the present invention;
FIG. 2 is a front view thereof;
FIG. 3 is a rear view thereof;
FIG. 4 is a left side view thereof
FIG. 5 is a right side view thereof;
FIG. 6 is a top view thereof; and,
FIG. 7 is a top right isometric view thereof.
The portions of the enclosure illustrated in broken lines forms no part of the design.

1 Claim, 7 Drawing Sheets

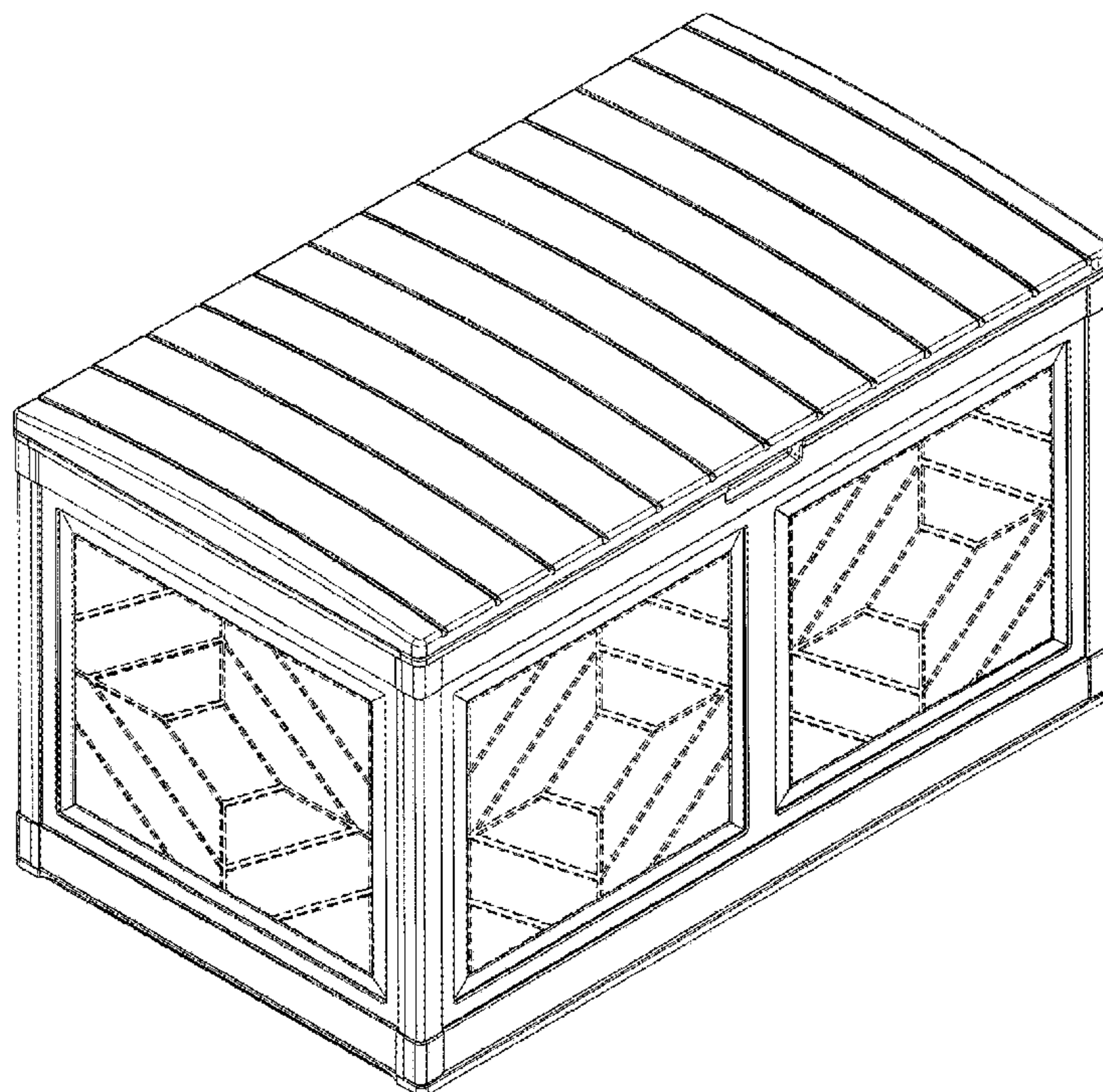

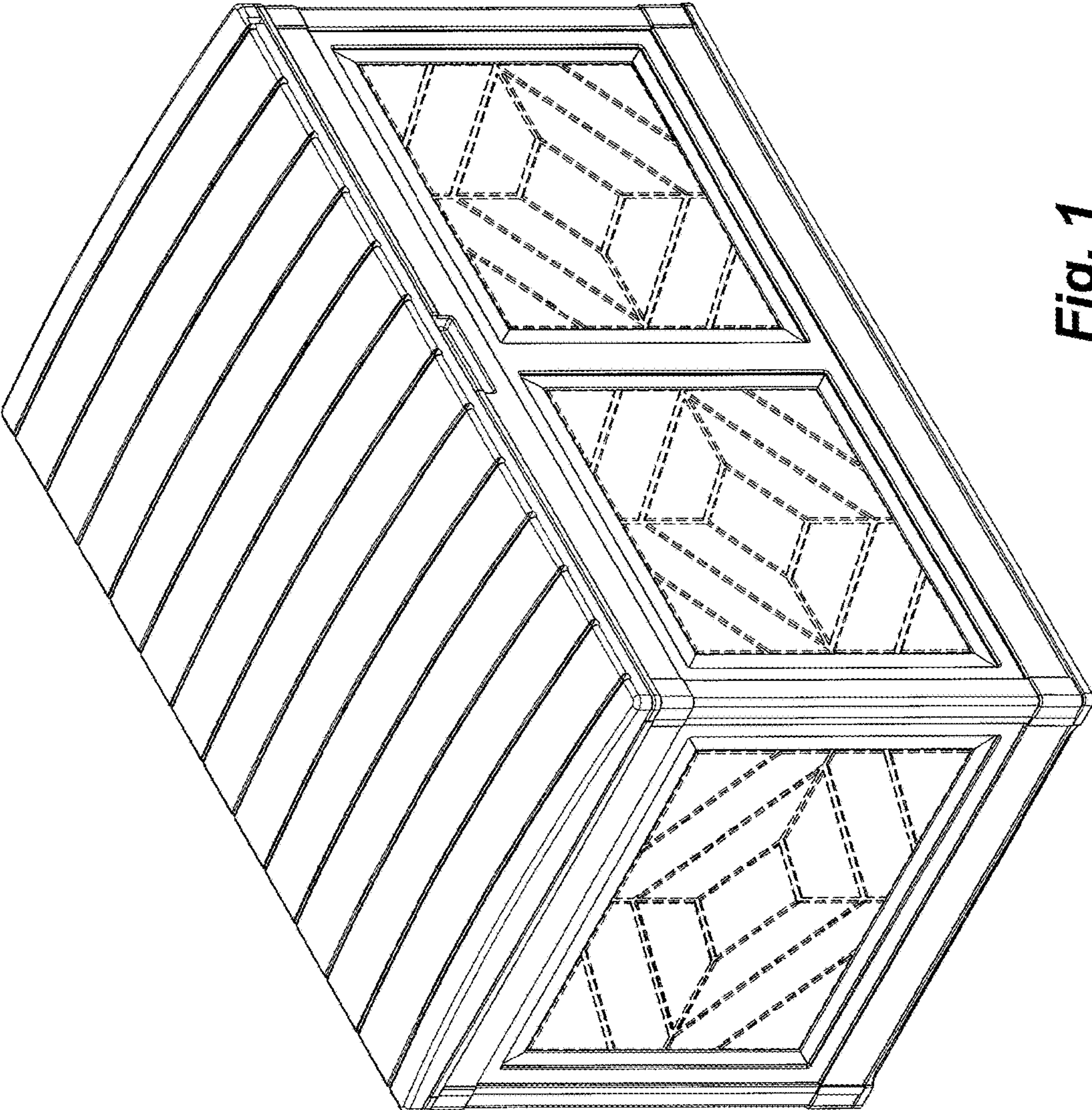

Fig. 1

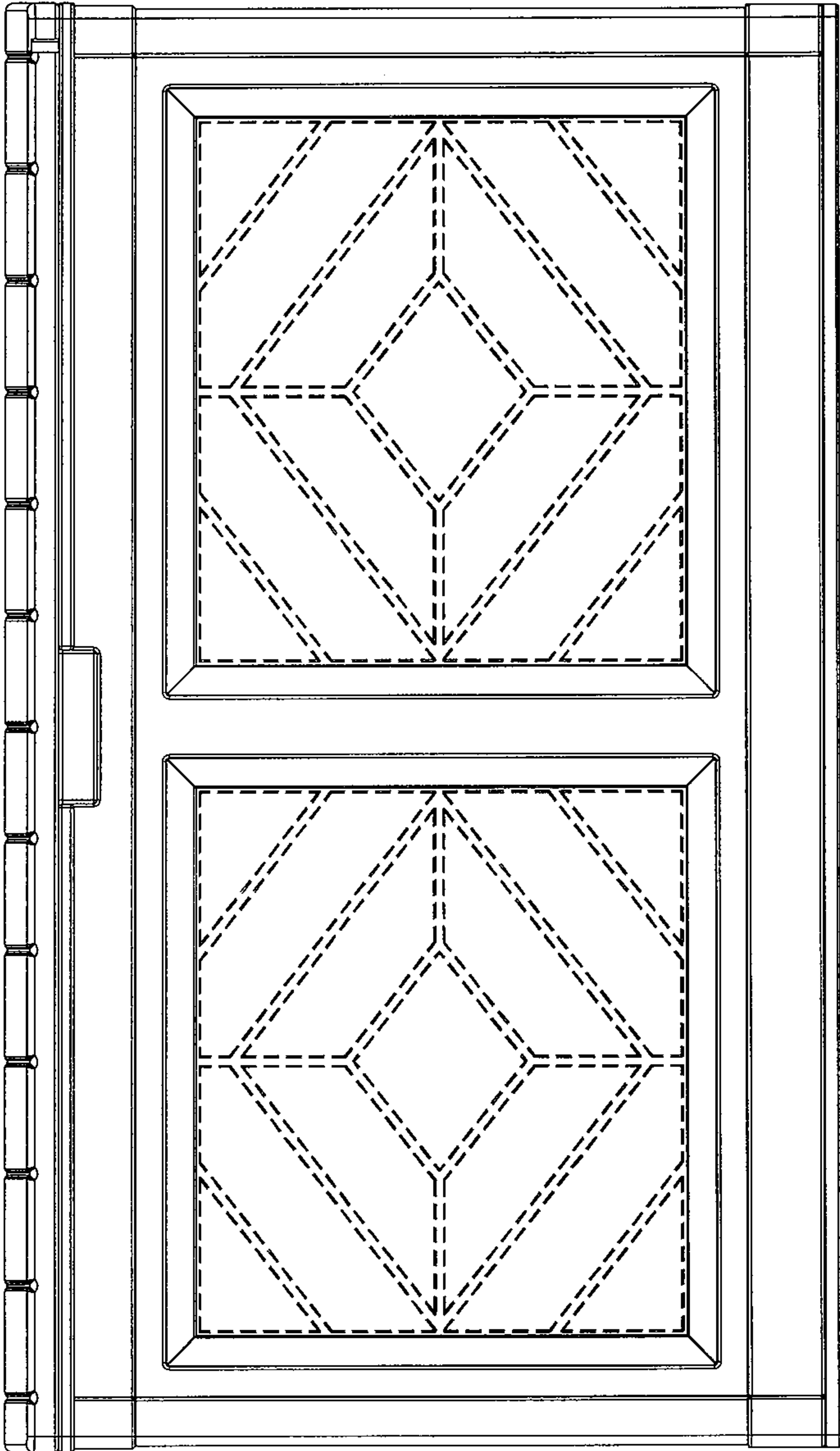

Fig. 2

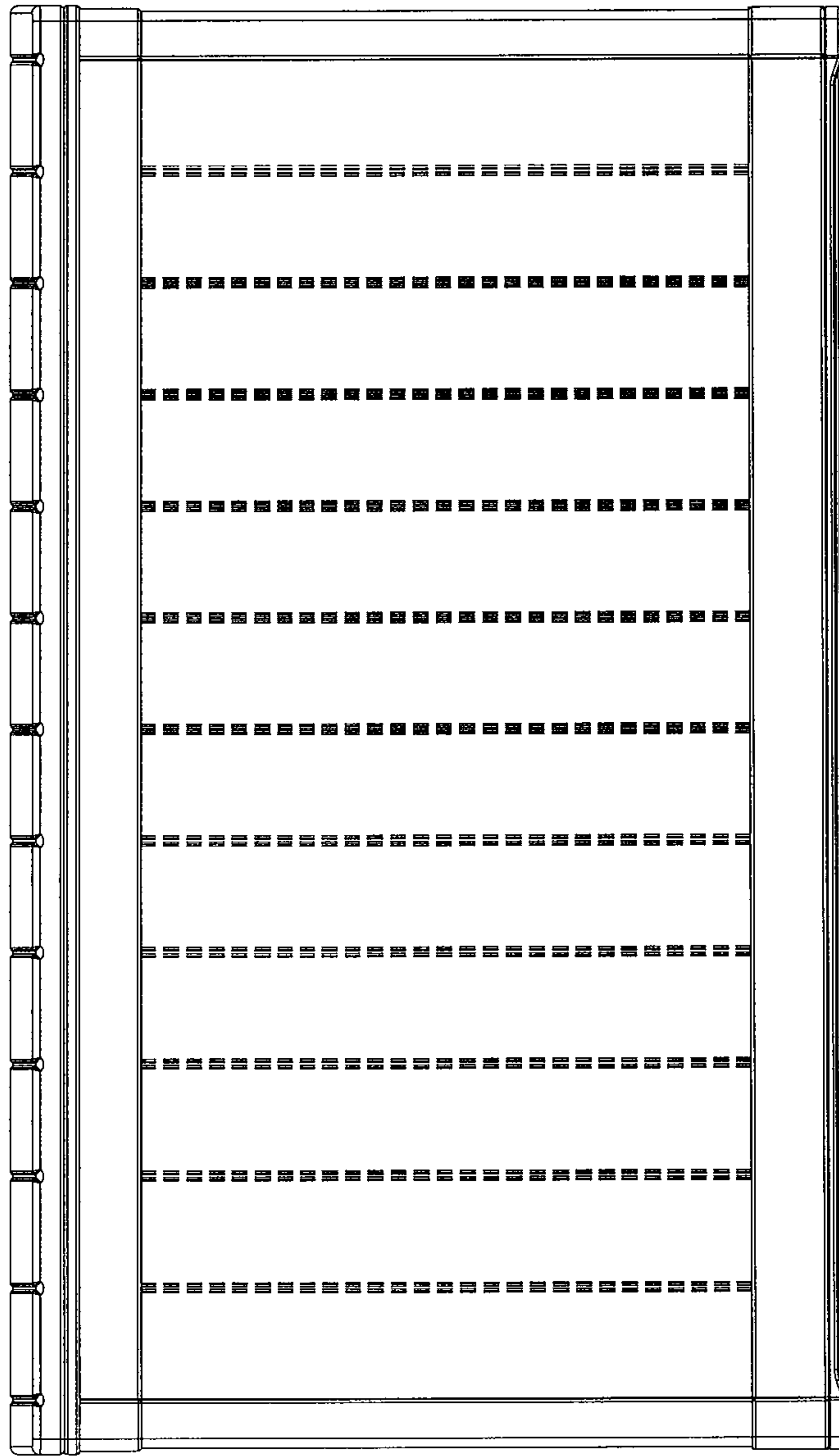

Fig. 3

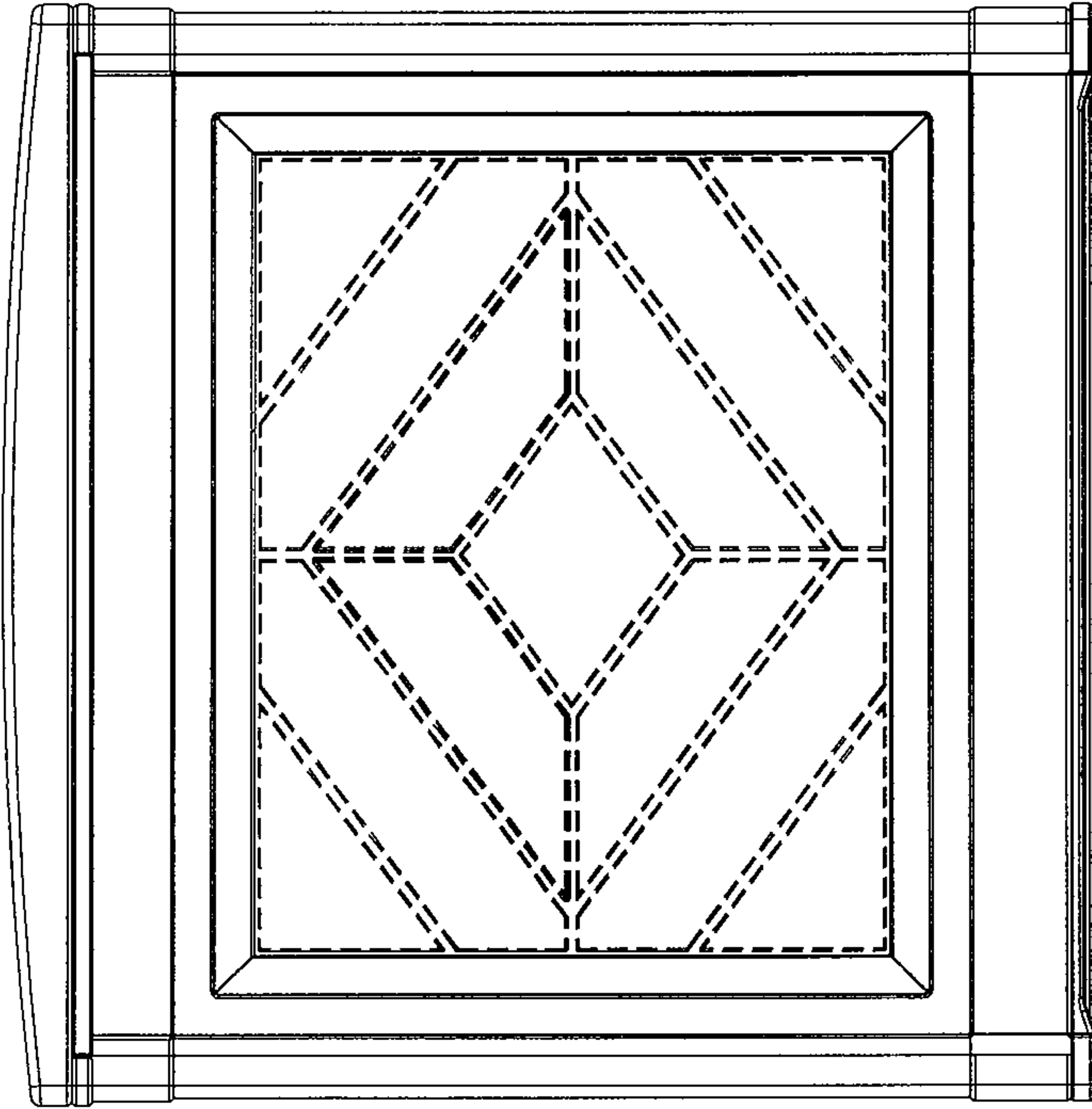

Fig. 4

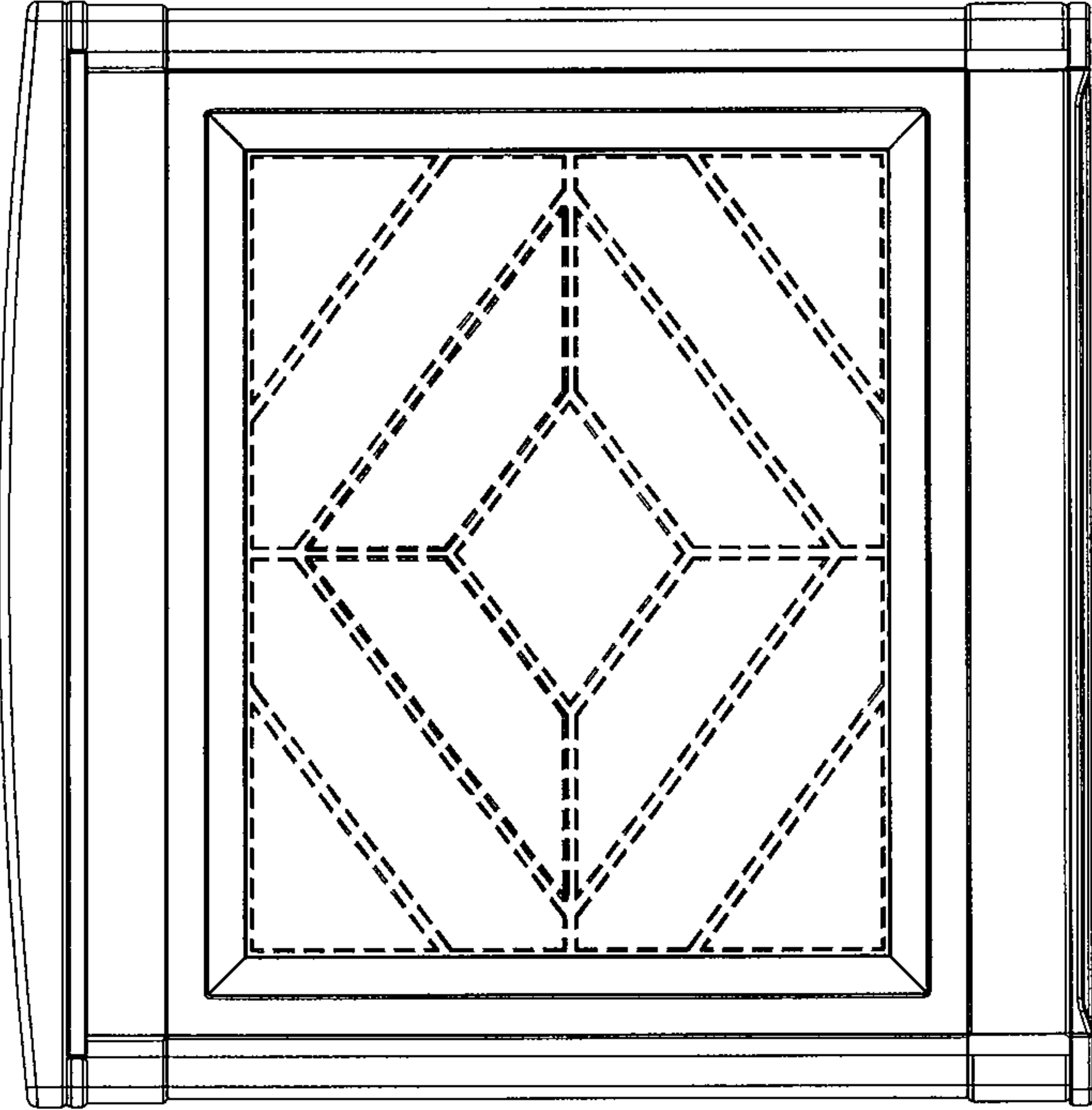

Fig. 5

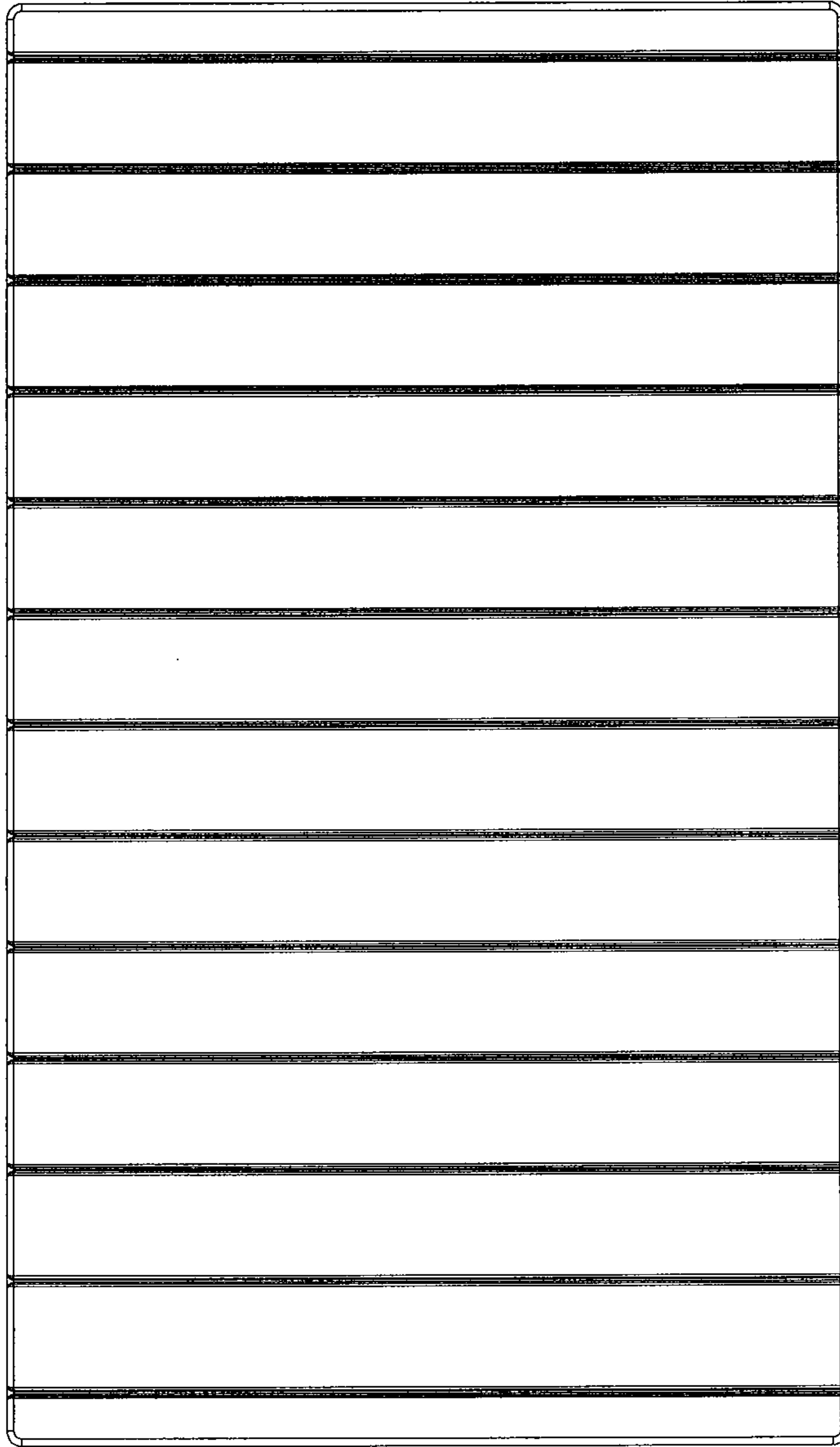

Fig. 6

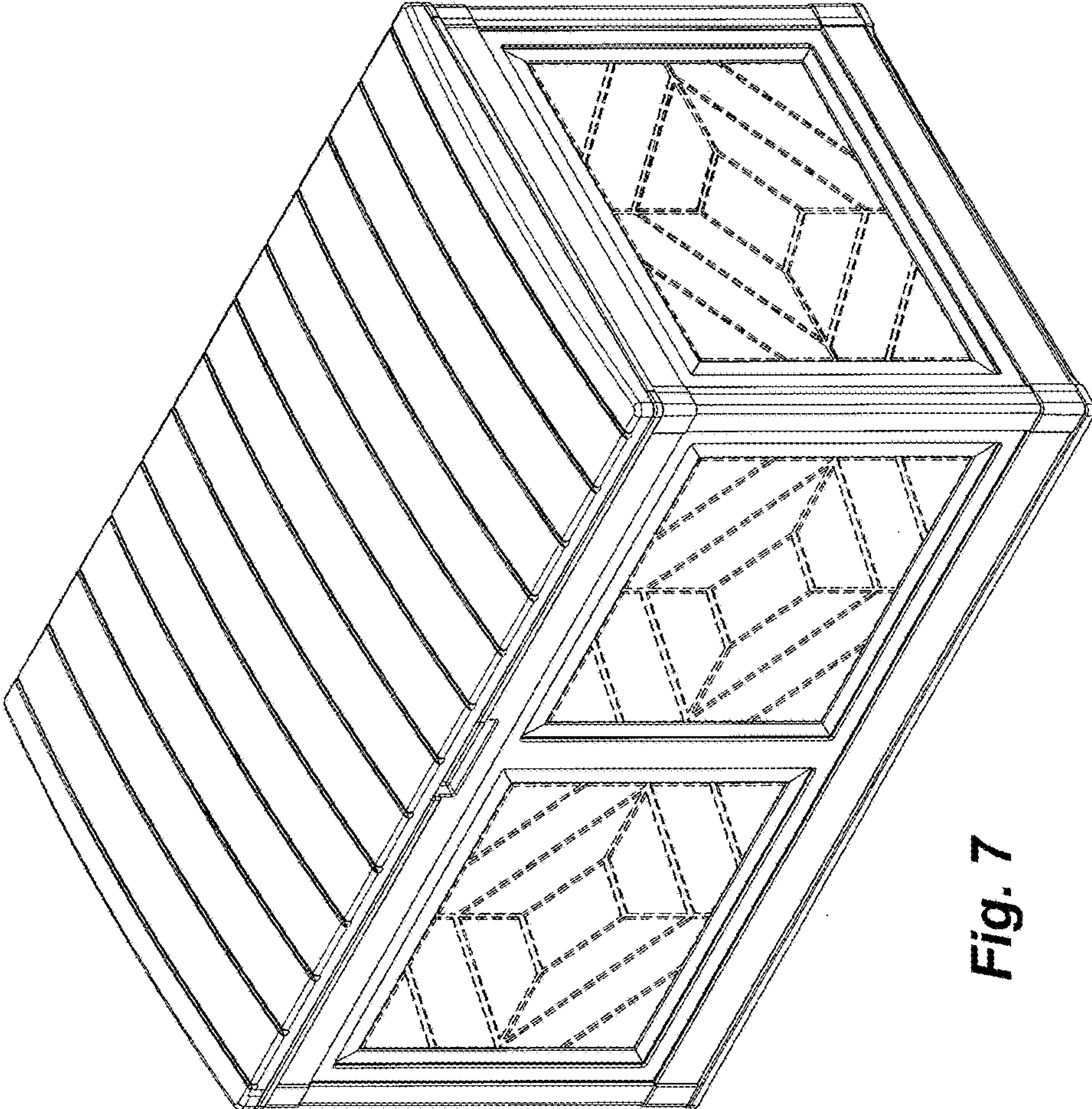

Fig. 7