



US00D788476S

(12) **United States Design Patent** (10) **Patent No.:** **US D788,476 S**
Denby et al. (45) **Date of Patent:** **** Jun. 6, 2017**

(54) **HANGER** D272,494 S * 2/1984 Mahowald D6/513
4,474,316 A 10/1984 Philibert
(71) Applicant: **TARGET BRANDS, INC.,** 4,526,306 A 7/1985 Zuckerman et al.
Minneapolis, MN (US) (Continued)

(72) Inventors: **Scott E. Denby**, Minneapolis, MN (US); **Christopher A. Hammond**, Edina, MN (US); **Wei Wu**, Eden Prairie, MN (US) FOREIGN PATENT DOCUMENTS
WO 9009651 A1 8/1990
WO 2006005036 A2 1/2006

(73) Assignee: **TARGET BRANDS, INC.,** Minneapolis, MN (US) OTHER PUBLICATIONS
“10 Pieces Dog Clothes Hanger,” printed from www.lovelonglong.com/10-pieces-dog-clothes-hanger-918, publicly available at least as early as Jun. 29, 2010, per http://web.archive.org (3 pages).
(Continued)

(**) Term: **15 Years**
(21) Appl. No.: **29/547,280**
(22) Filed: **Dec. 2, 2015**
(51) **LOC (10) Cl.** **06-08**
(52) **U.S. Cl.**
USPC **D6/315**

(58) **Field of Classification Search**
USPC D6/315–328; 223/85–98; 211/1, 13.1, 211/85.3, 113
CPC A47G 25/28; A47G 25/743; A47G 25/26; A47G 25/442; A47G 25/30; A47G 25/36; A47G 25/16; A47G 25/14; A47G 25/18; A47G 25/005; A47F 7/19; A47F 7/00
See application file for complete search history.

(56) **References Cited**
U.S. PATENT DOCUMENTS
3,172,531 A 3/1965 Shillman
D202,954 S * 11/1965 Hanson 223/92
3,414,175 A * 12/1968 Brosk A47F 5/0006
206/216
D222,513 S * 10/1971 Hart et al. D6/315
3,710,996 A 1/1973 Smilow et al.
3,841,478 A 10/1974 Wells et al.
D235,316 S * 6/1975 Wells D6/327
4,177,908 A 12/1979 Batts et al.
D264,912 S 6/1982 Bliss et al.

Primary Examiner — Derrick Holland
Assistant Examiner — Lauren Calve
(74) *Attorney, Agent, or Firm* — JoAnn M. Seaton; Griffiths & Seaton PLLC

(57) **CLAIM**
The ornamental design for a hanger, as shown and described.

DESCRIPTION
FIG. 1 is a top and front perspective view of a hanger showing our new design;
FIG. 2 is a front view thereof;
FIG. 3 is a rear view thereof;
FIG. 4 is a right side view thereof;
FIG. 5 is a left side view thereof;
FIG. 6 is a top view thereof; and,
FIG. 7 is a bottom view thereof.
In the drawings, the broken lines depict unclaimed subject matter only and form no part of the claimed design. The features shown in long dash-short dash bolded broken lines indicate the bounds of the claimed design and otherwise form no part of the claimed design.

1 Claim, 4 Drawing Sheets

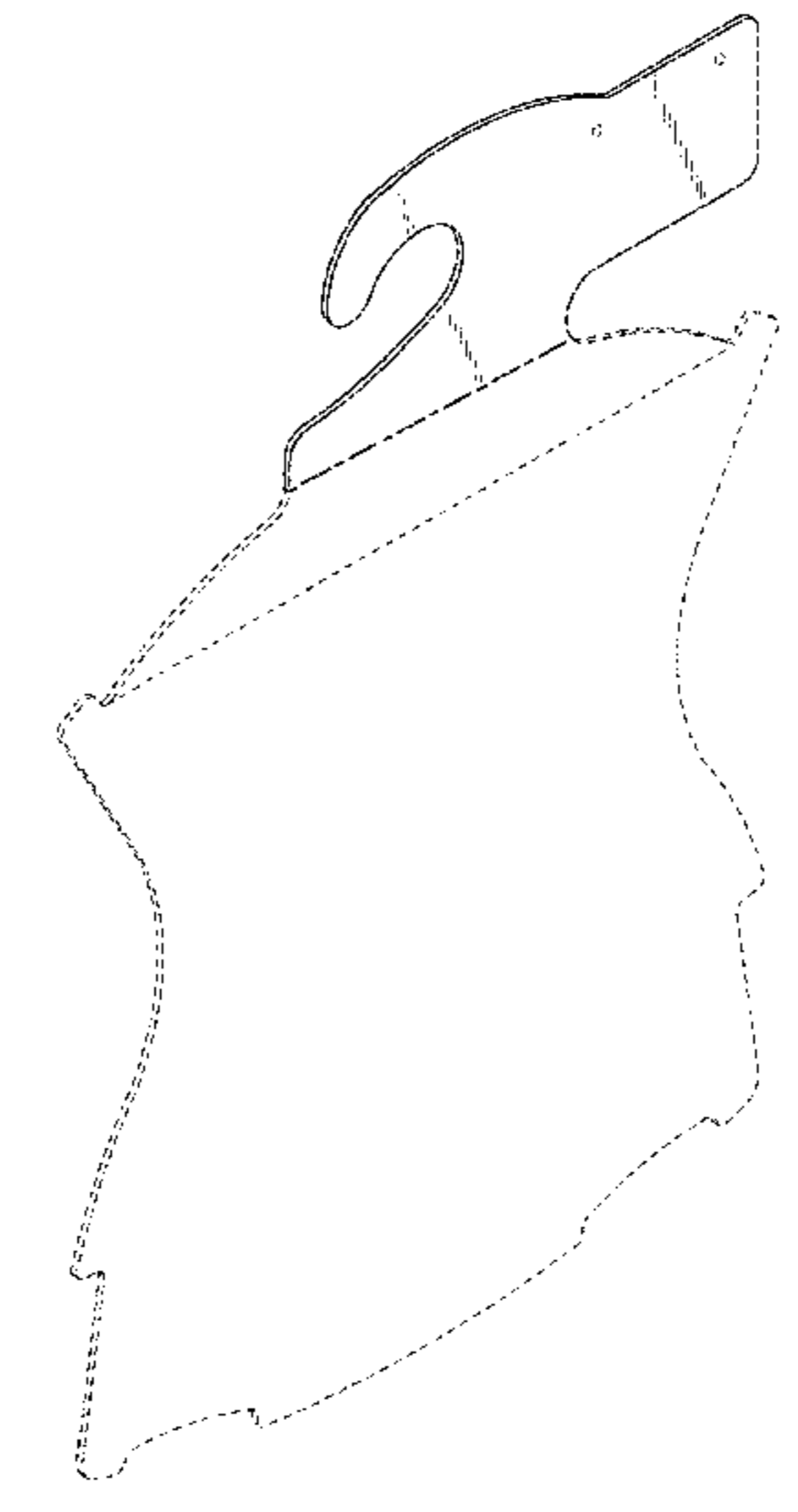

(56)

References Cited

U.S. PATENT DOCUMENTS

4,542,838 A 9/1985 Perez-Tubens et al.
 D282,790 S * 3/1986 Morawski D6/327
 D282,982 S 3/1986 Kodet
 D301,943 S 7/1989 Wilson
 D303,325 S 9/1989 Marshall
 4,865,236 A 9/1989 Dongas
 5,388,354 A 2/1995 Marshall et al.
 5,421,465 A 6/1995 Dunner, Jr.
 5,423,505 A * 6/1995 David A47F 5/0006
 206/486
 D365,690 S * 1/1996 Charlet D6/315
 D368,590 S * 4/1996 Charlet D6/315
 5,556,014 A 9/1996 Kolton et al.
 D376,263 S 12/1996 Gouldson
 D377,637 S * 1/1997 Berry, Jr. D12/193
 D377,868 S * 2/1997 Charlet D6/315
 5,615,810 A 4/1997 Kolton et al.
 5,628,132 A 5/1997 Marshall et al.
 5,758,806 A 6/1998 Anderson
 5,775,553 A 7/1998 Marshall et al.
 5,785,216 A 7/1998 Gouldson et al.
 5,794,363 A 8/1998 Marshall et al.
 D401,705 S 11/1998 Jones
 5,857,276 A 1/1999 Marshall et al.
 5,868,289 A 2/1999 Lee
 5,884,422 A 3/1999 Marshall et al.
 D410,793 S 6/1999 Gouldson
 5,911,347 A 6/1999 Jackstat et al.
 5,944,237 A 8/1999 Gouldson
 D414,044 S 9/1999 Choi et al.
 6,029,868 A 2/2000 Willinger et al.
 6,264,075 B1 7/2001 Gouldson et al.
 6,289,569 B1 9/2001 Marshall et al.
 6,421,910 B1 7/2002 Marshall et al.
 6,422,437 B2 7/2002 Gouldson et al.
 6,564,980 B2 5/2003 Gouldson et al.
 6,622,897 B2 9/2003 Bokmiller et al.
 6,644,520 B2 11/2003 Lam
 6,705,496 B2 3/2004 Marshall et al.
 6,726,067 B2 4/2004 Louw
 6,865,832 B1 3/2005 Goldman
 6,915,931 B2 7/2005 Gouldson et al.
 6,932,251 B2 8/2005 Kolton et al.
 6,948,269 B2 9/2005 Wang
 6,978,917 B2 12/2005 Giustini et al.
 D525,661 S * 7/2006 Hussaini D20/43

7,178,705 B1 2/2007 Sutton
 7,201,297 B1 4/2007 Baziuk
 D547,557 S 7/2007 Wu
 7,240,813 B1 7/2007 Goldman
 7,264,115 B1 9/2007 Uittenbogaard et al.
 7,278,558 B1 10/2007 Sutton et al.
 7,278,559 B1 10/2007 Sutton et al.
 7,303,101 B2 12/2007 Goldman
 D560,373 S 1/2008 Gouldson
 7,318,540 B1 1/2008 Sutton et al.
 7,380,359 B2 6/2008 Mainetti
 7,389,885 B2 * 6/2008 Masanek, Jr. A47F 5/0006
 211/113
 D577,496 S 9/2008 Gouldson
 D578,778 S * 10/2008 Laino D6/315
 D581,985 S * 12/2008 Spratt D20/42
 7,464,842 B2 12/2008 Gouldson
 7,516,875 B2 4/2009 Gouldson
 D605,861 S * 12/2009 Meadows D6/315
 7,641,083 B2 1/2010 Goldman et al.
 7,708,174 B1 5/2010 Ho
 7,717,308 B2 5/2010 Goldman
 7,841,495 B2 11/2010 Gouldson
 7,905,376 B2 3/2011 Gouldson
 7,922,047 B2 4/2011 Gouldson
 D647,709 S 11/2011 Anderson et al.
 D648,140 S 11/2011 Ferraro et al.
 D648,142 S 11/2011 Ferraro et al.
 8,113,392 B2 2/2012 Gouldson
 8,113,394 B2 2/2012 Ho
 8,141,756 B2 3/2012 Mainetti
 8,225,538 B2 7/2012 Warren et al.
 8,281,965 B2 10/2012 Chan
 8,286,841 B2 10/2012 Louw
 8,418,894 B2 4/2013 Gouldson
 8,444,029 B2 5/2013 Ferraro et al.
 D711,658 S 8/2014 Pelton et al.
 2003/0209577 A1 11/2003 Gouldson et al.
 2007/0199965 A1 8/2007 Gouldson
 2007/0246490 A1 10/2007 Gouldson

OTHER PUBLICATIONS

“Children’s White Plastic Clothing Set Economy Hangers,” printed from www.storesupply.com/pc-14148-1263-childrens-dress-hangers-white-25142.aspx, publicly available at least as early as Sep. 19, 2011, per <http://web.archive.org> (2 pages).

* cited by examiner

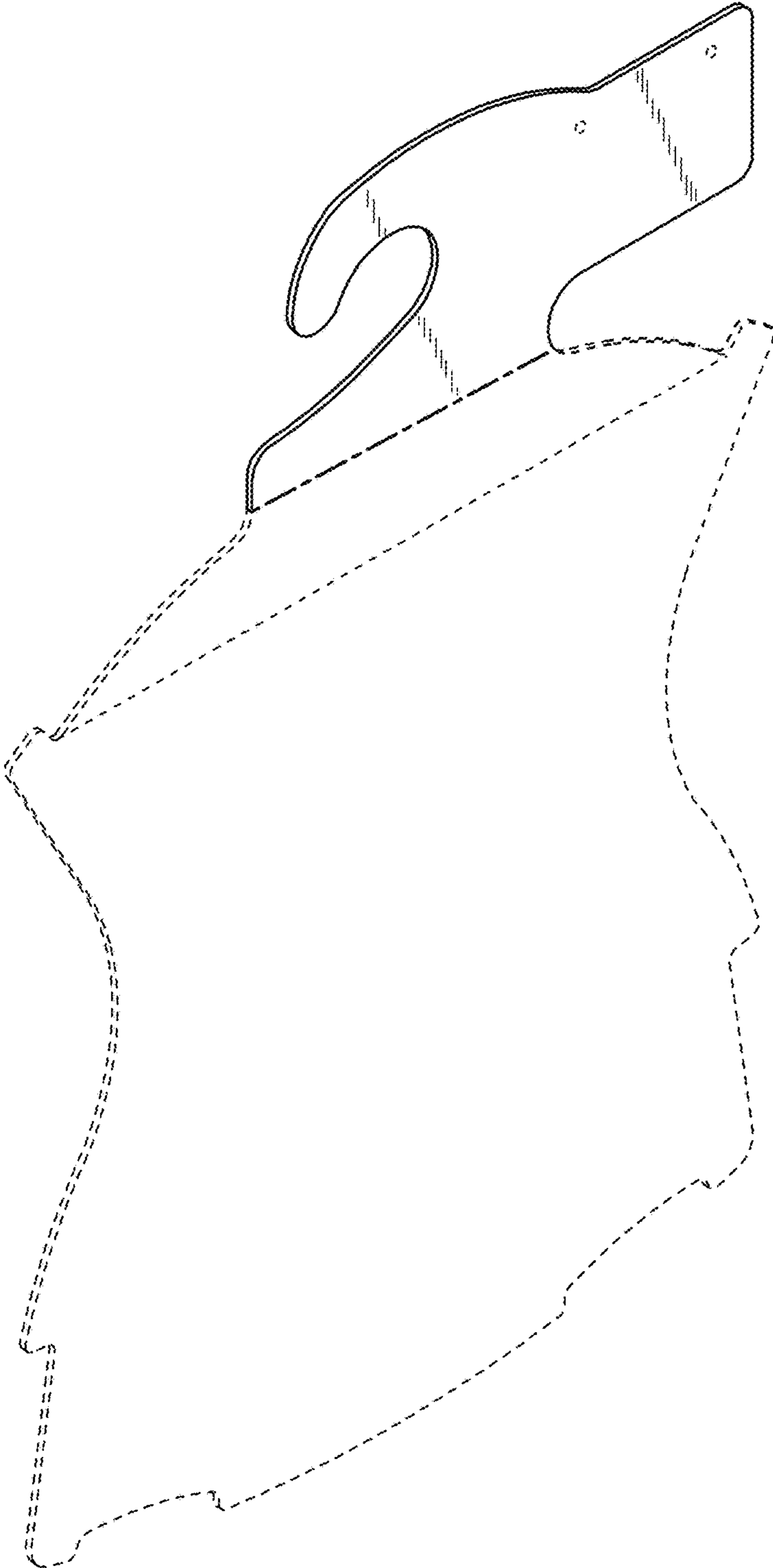

FIG. 1

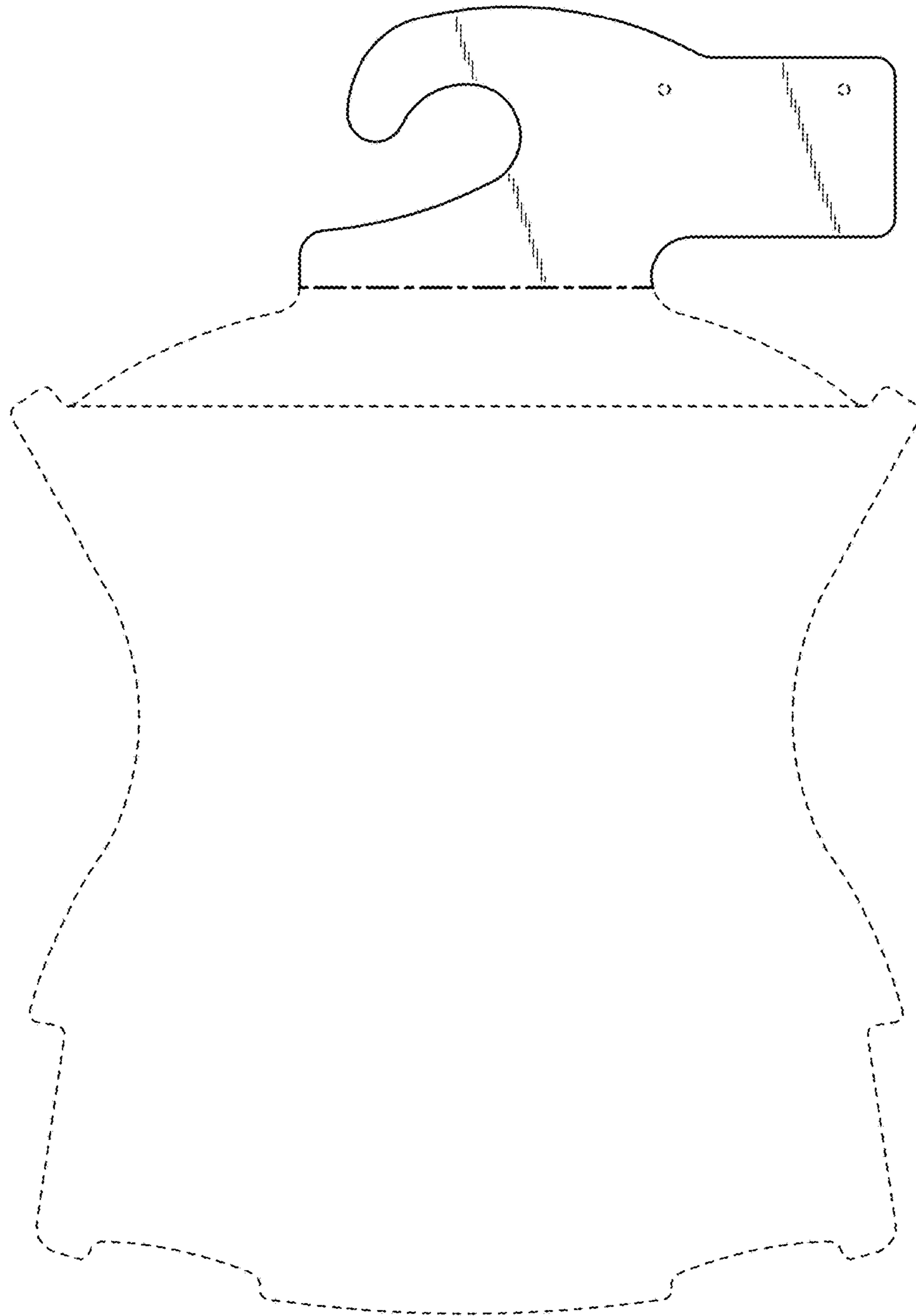

FIG. 2

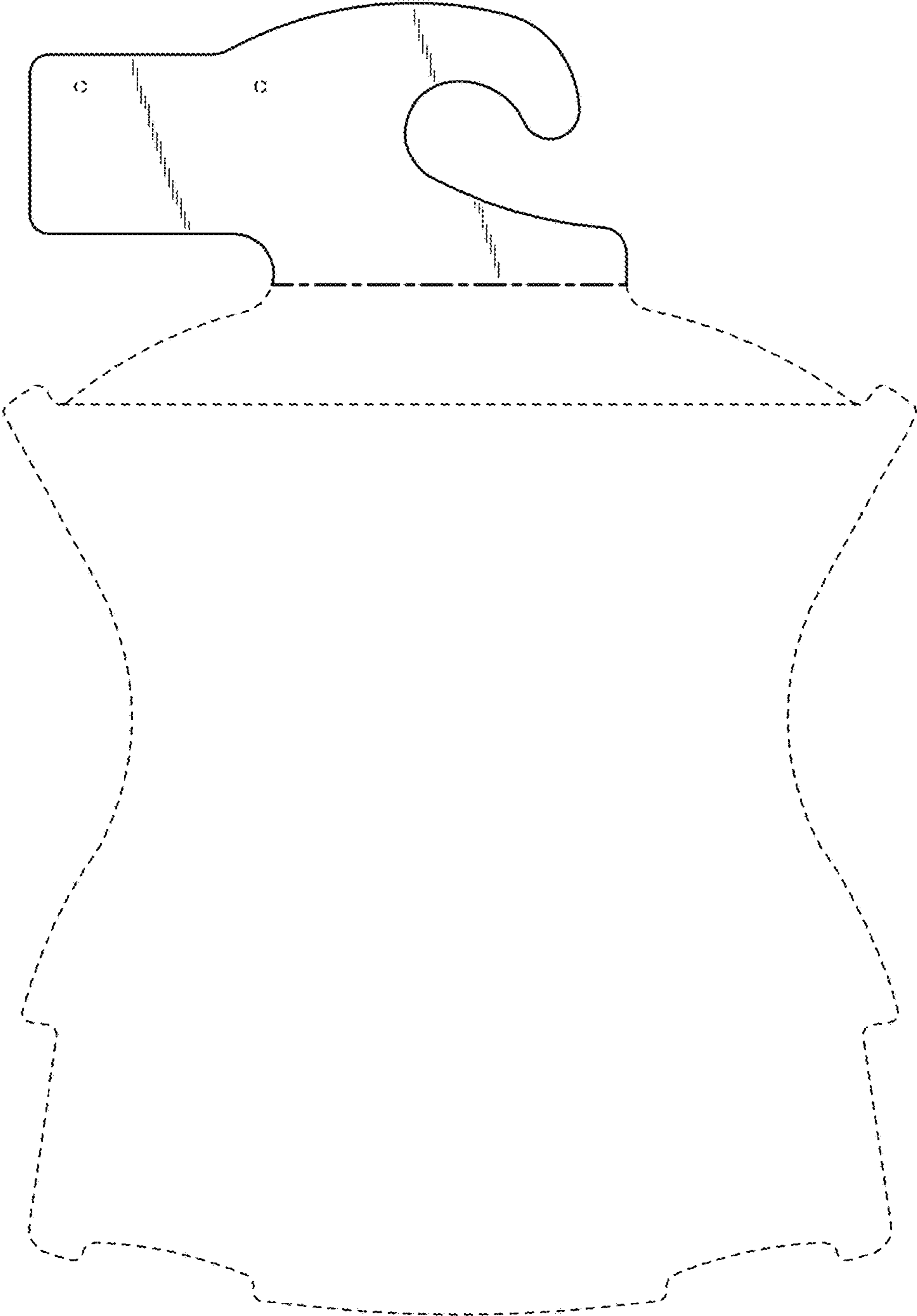

FIG. 3

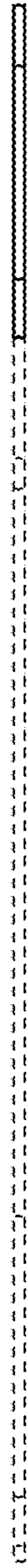

FIG. 4

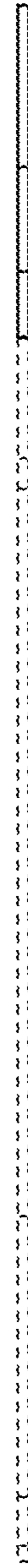

FIG. 5

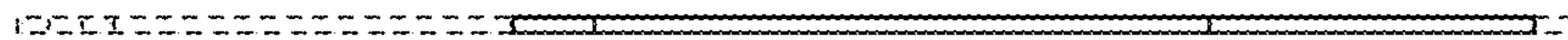

FIG. 6



FIG. 7