



US00D788459S

(12) **United States Design Patent**  
**Barnard**

(10) **Patent No.:** **US D788,459 S**

(45) **Date of Patent:** **\*\* Jun. 6, 2017**

(54) **HANDBAG**

(71) Applicant: **Jennifer Barnard**, Founex VD (CH)

(72) Inventor: **Jennifer Barnard**, Founex (CH)

(\*\*) Term: **15 Years**

(21) Appl. No.: **35/500,194**

(22) Filed: **May 15, 2015**

(80) **Hague Agreement Data**

Int. Filing Date: **May 15, 2015**

Int. Reg. No.: **DM/087701**

Int. Reg. Date: **May 15, 2015**

Int. Reg. Pub. Date: **Oct. 16, 2015**

(51) **LOC (10) Cl.** ..... **03-01**

(52) **U.S. Cl.**  
USPC ..... **D3/245**

(58) **Field of Classification Search**  
USPC ..... D3/232-233, 240-243, 245-246;  
150/100, 103-110, 113-114, 117-119  
See application file for complete search history.

(56) **References Cited**

**U.S. PATENT DOCUMENTS**

D109,131 S *	4/1938	Felmann	.....	D3/246
D139,763 S *	12/1944	Nash	.....	D3/243
D166,465 S *	4/1952	Hardy	.....	D3/242
D333,260 S *	2/1993	Collaso	.....	D3/243
D342,383 S *	12/1993	Fuchs	.....	D3/239
D347,323 S *	5/1994	Ringblum	.....	D3/239
D512,566 S *	12/2005	Nuovo	.....	D3/321
D519,732 S *	5/2006	Gonzalez	.....	D3/243
D559,542 S *	1/2008	Nair	.....	D3/246

**OTHER PUBLICATIONS**

Soft-Carbon bag from Purisme, posted Sep. 18, 2009 [online], [retrieved Feb. 2, 2016]. Retrieved from internet, [http://luxurylaunches.com/fashion/softcarbon\\_bag\\_from\\_purisme\\_is\\_sleek\\_and\\_stylish.php](http://luxurylaunches.com/fashion/softcarbon_bag_from_purisme_is_sleek_and_stylish.php).\*

\* cited by examiner

*Primary Examiner* — Barbara Fox

(57) **CLAIM**

The ornamental design for handbag, as shown and described.

**DESCRIPTION**

1. Handbag
2. Handbag in carbon
3. Handbag in carbon with decoration
- 1.1 : Front
- 1.2 : Right
- 1.3 : Top
- 1.4 : Bottom
- 2.1 : Front
- 2.2 : Back
- 2.3 : Top
- 2.4 : Bottom
- 2.5 : Left
- 2.6 : Perspective
- 2.7 : Perspective
- 3.1 : Front
- 3.2 : Back
- 3.3 : Top
- 3.4 : Bottom
- 3.5 : Left
- 3.6 : Perspective
- 3.7 : Perspective

**1 Claim, 18 Drawing Sheets**

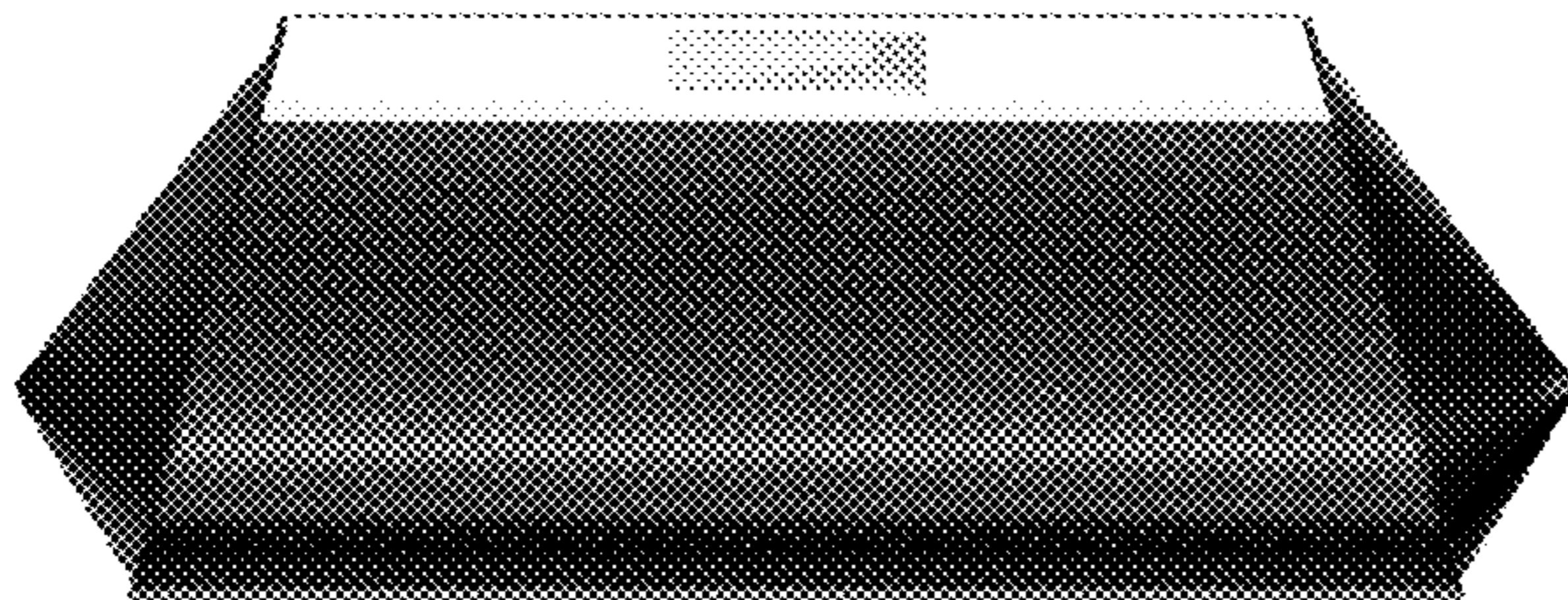

1.1

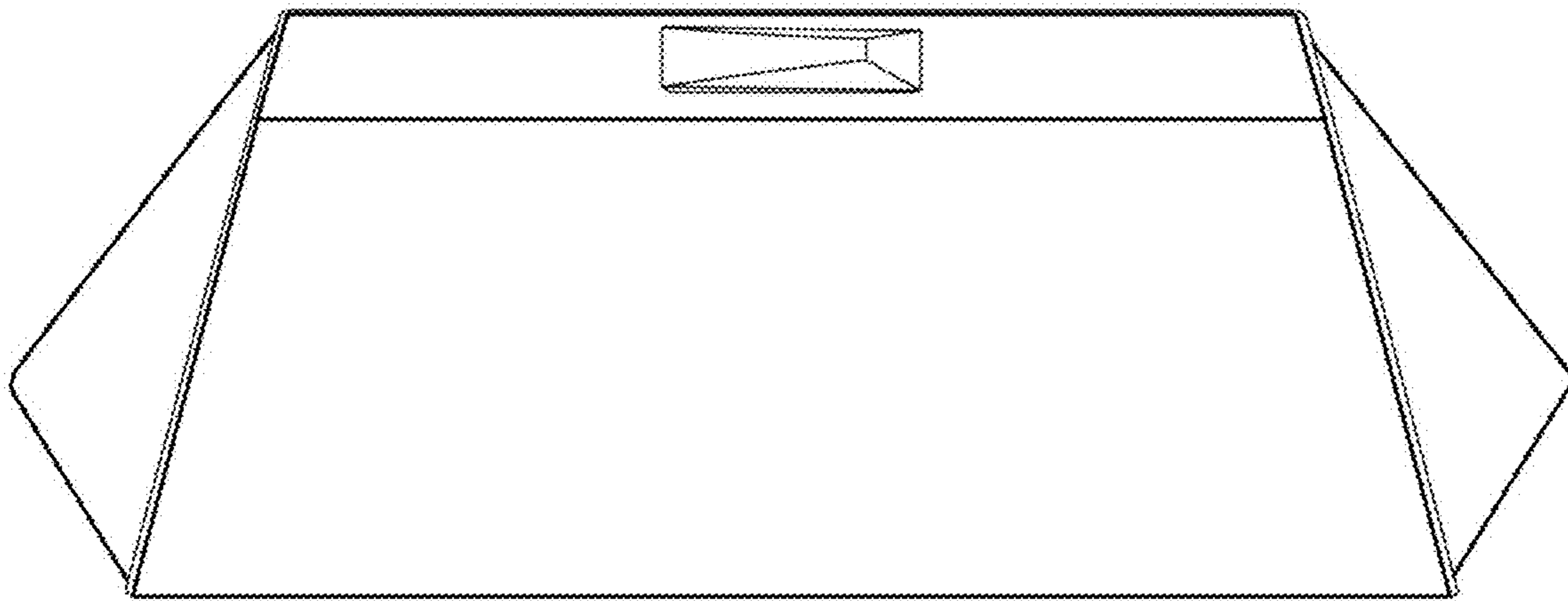

1.2

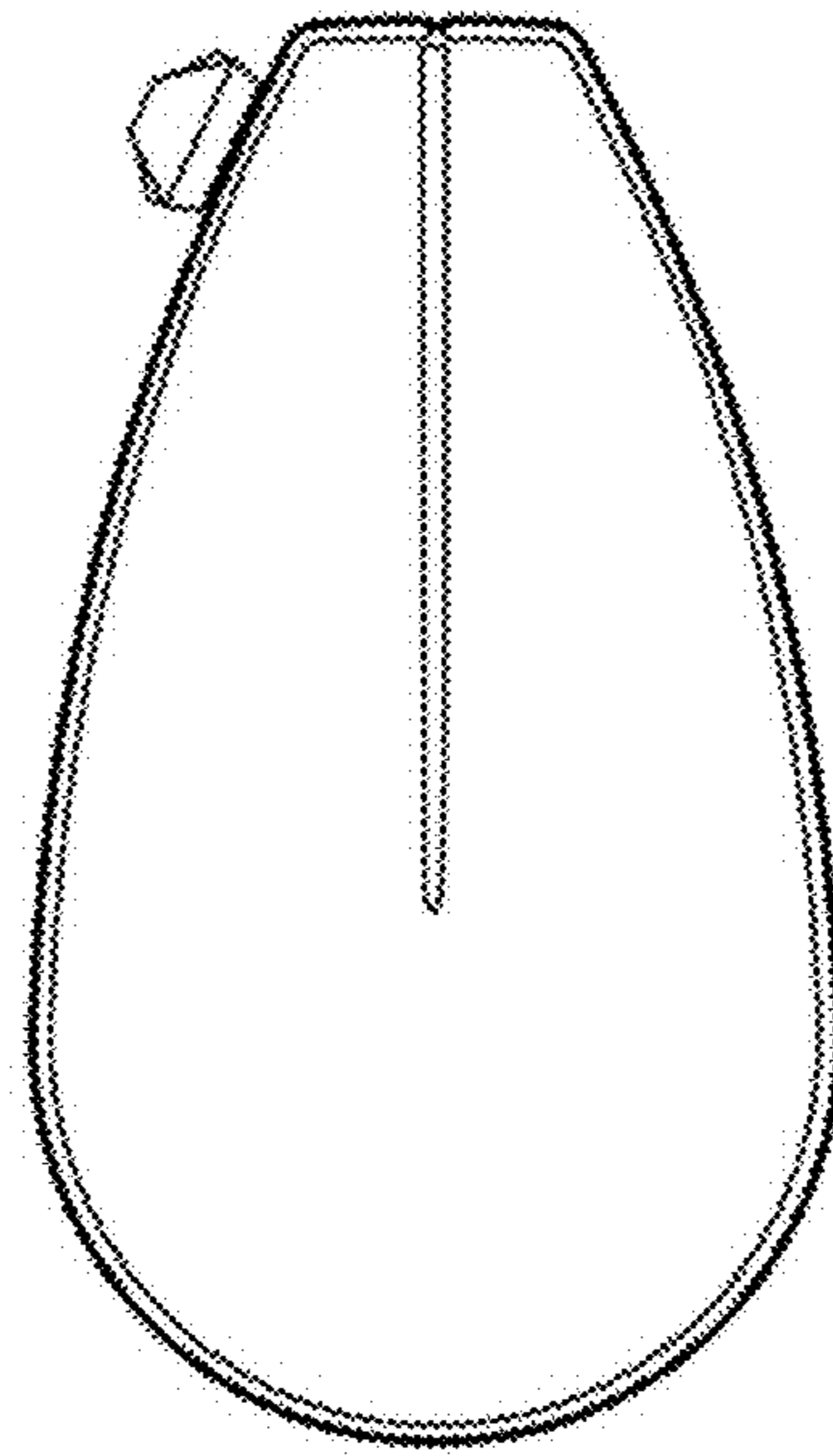

1.3

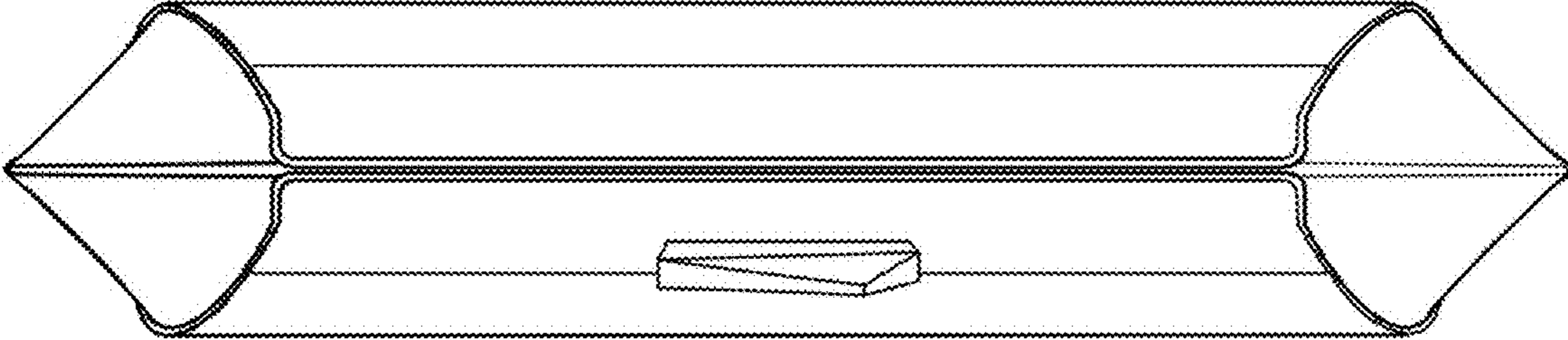

1.4



2.1

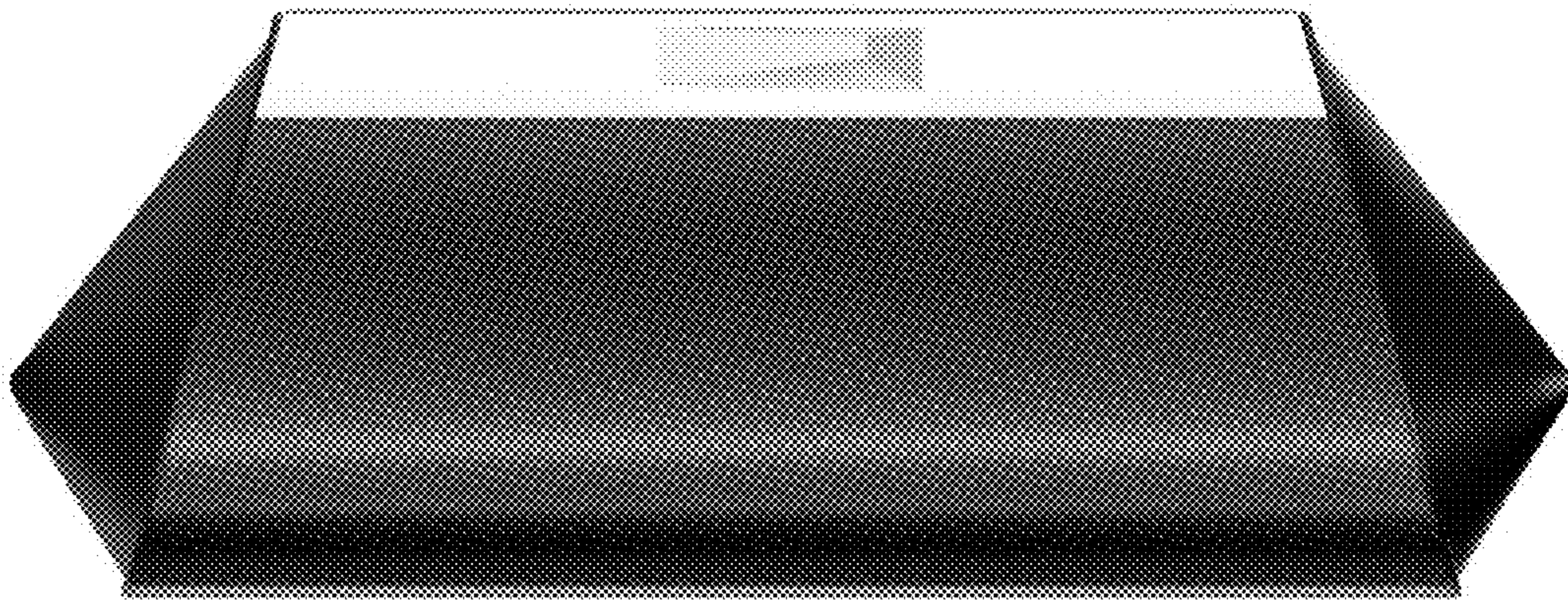

2.2

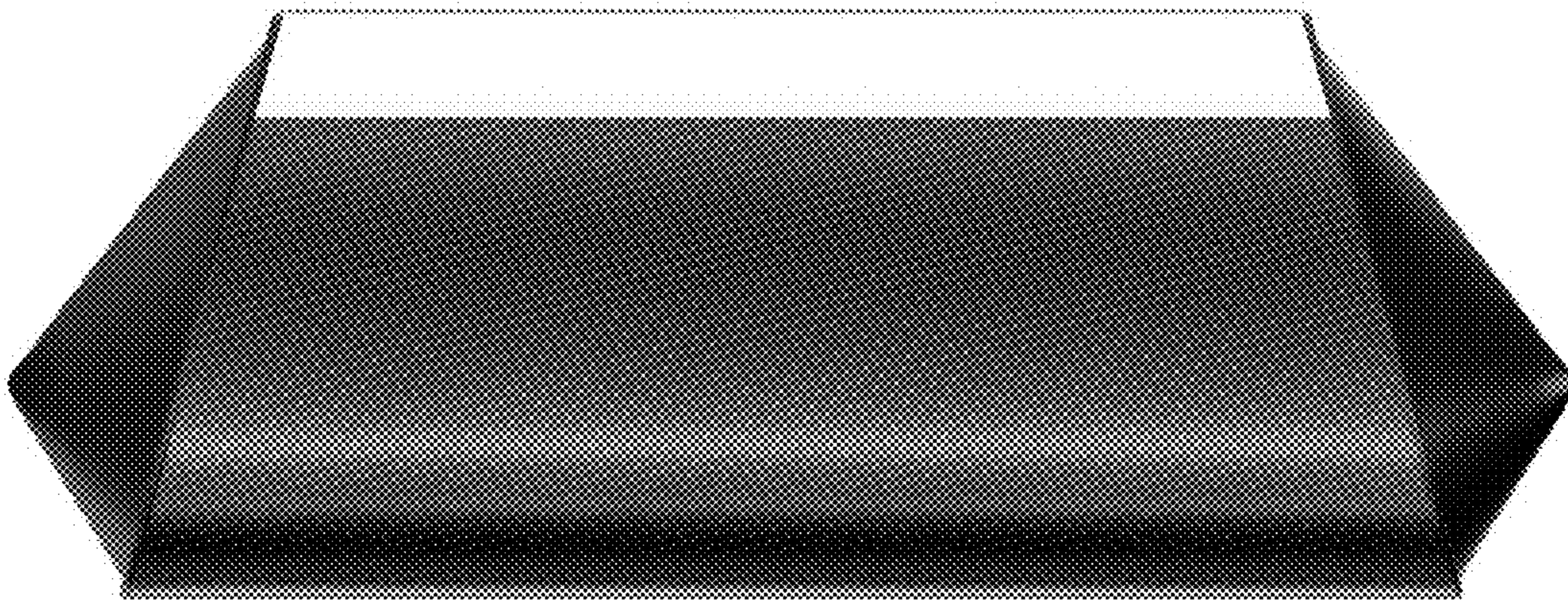

2.3

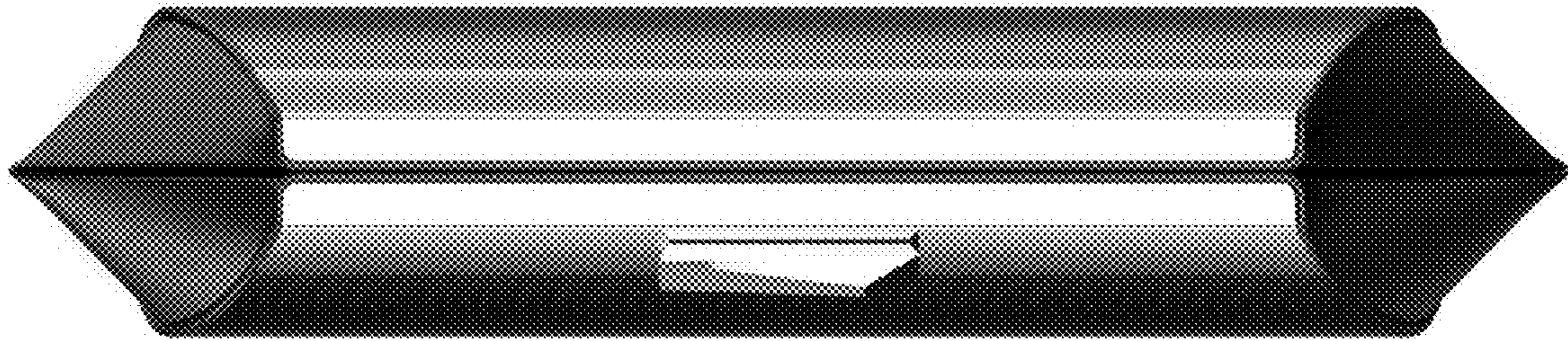



2.4

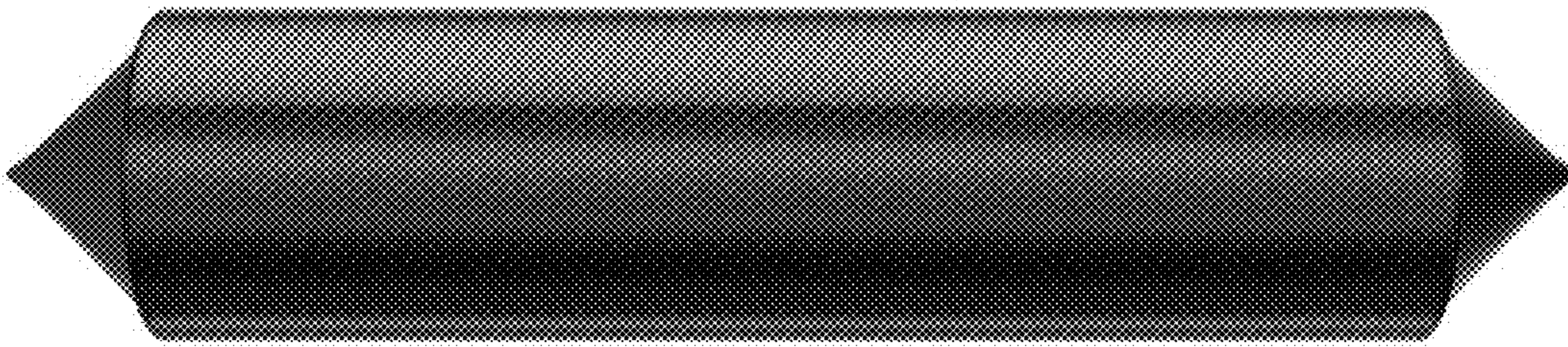

2.5

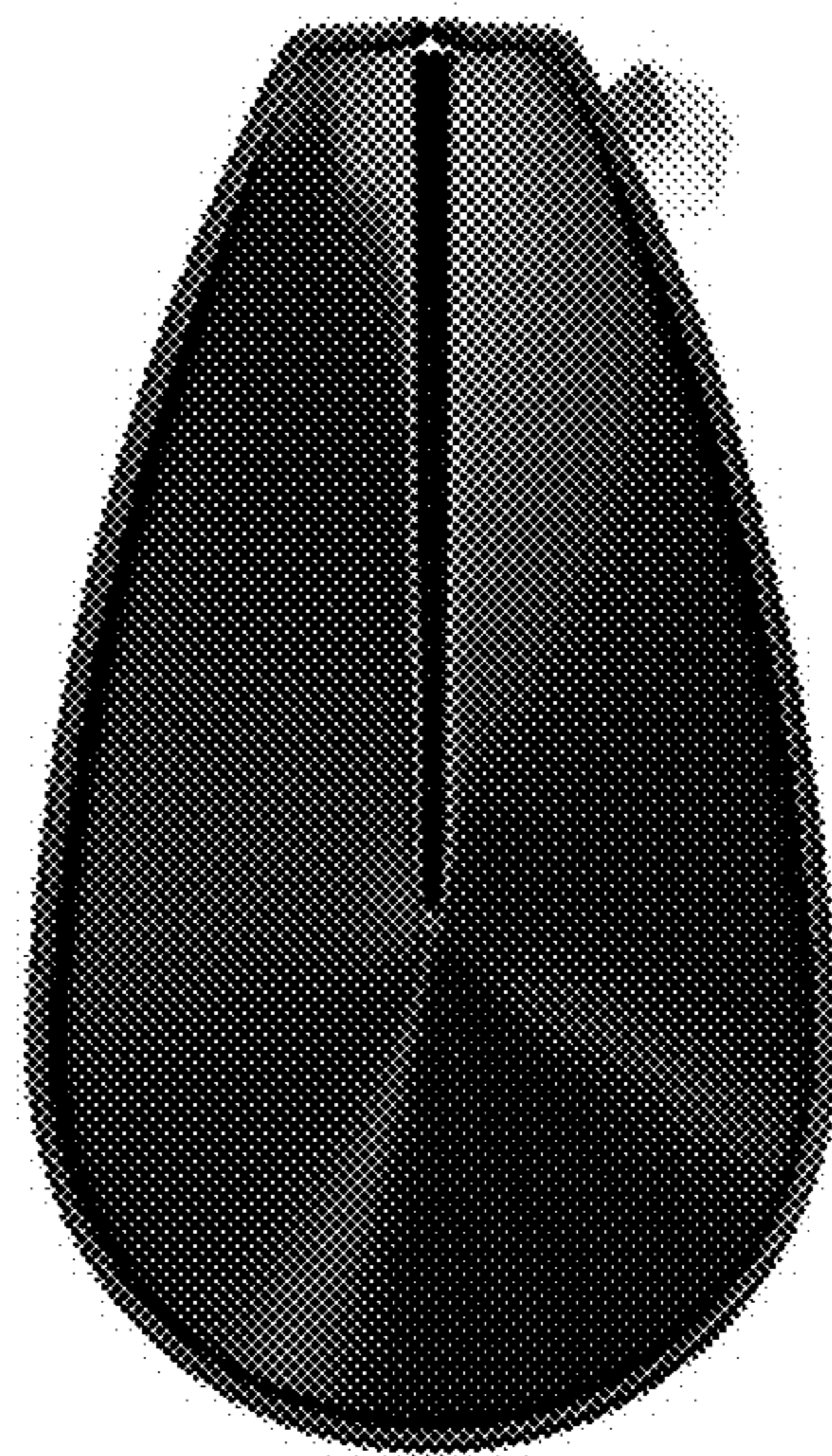

2.6



2.7



3.1

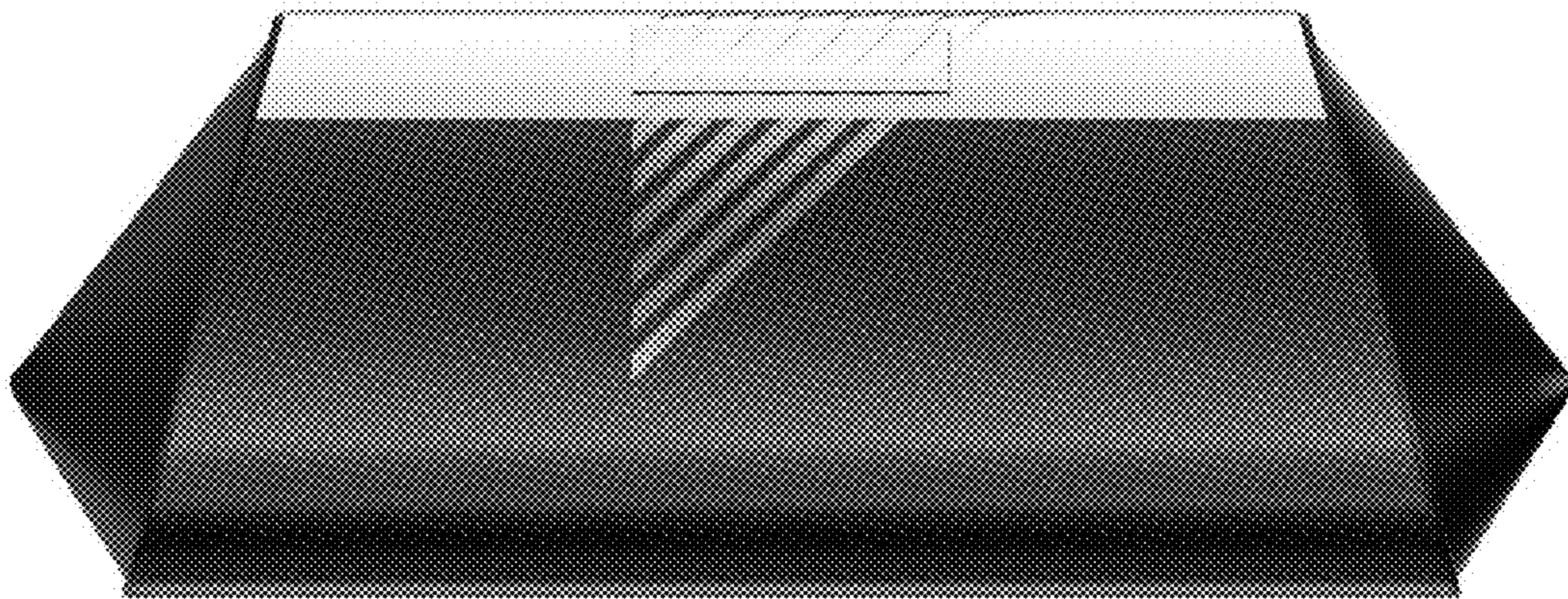

3.2

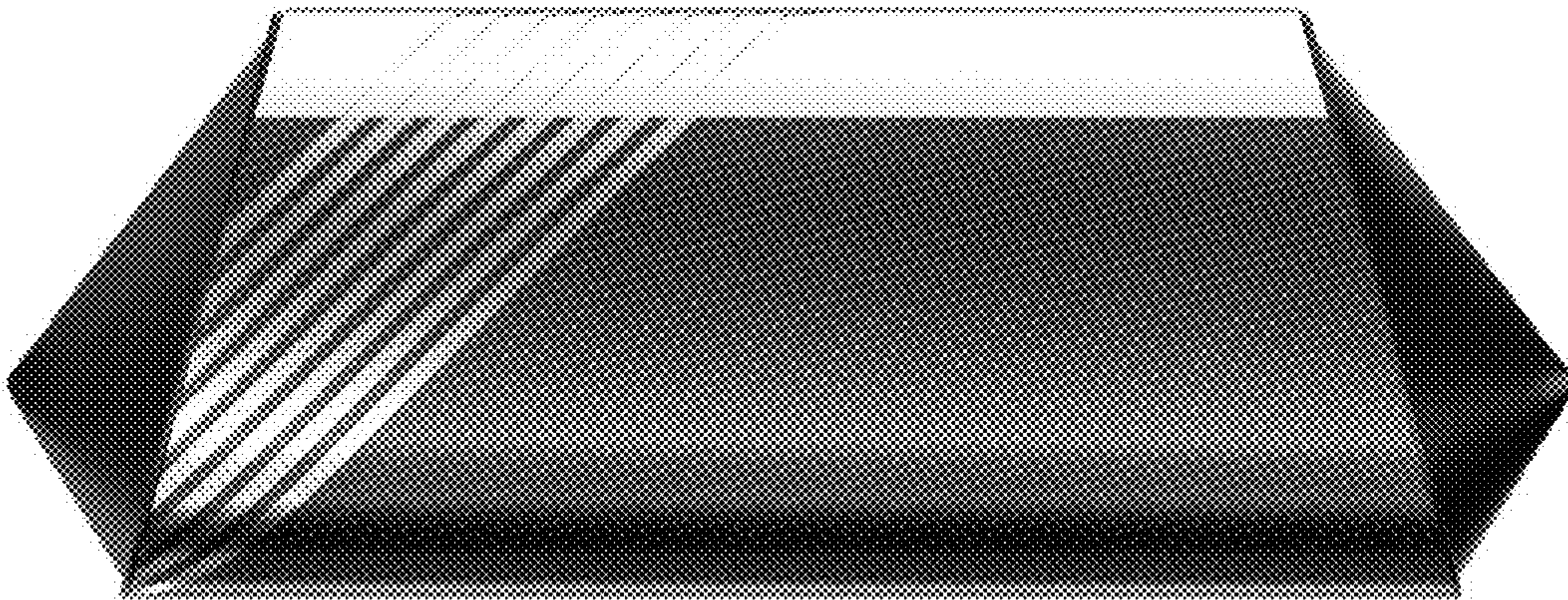

3.3

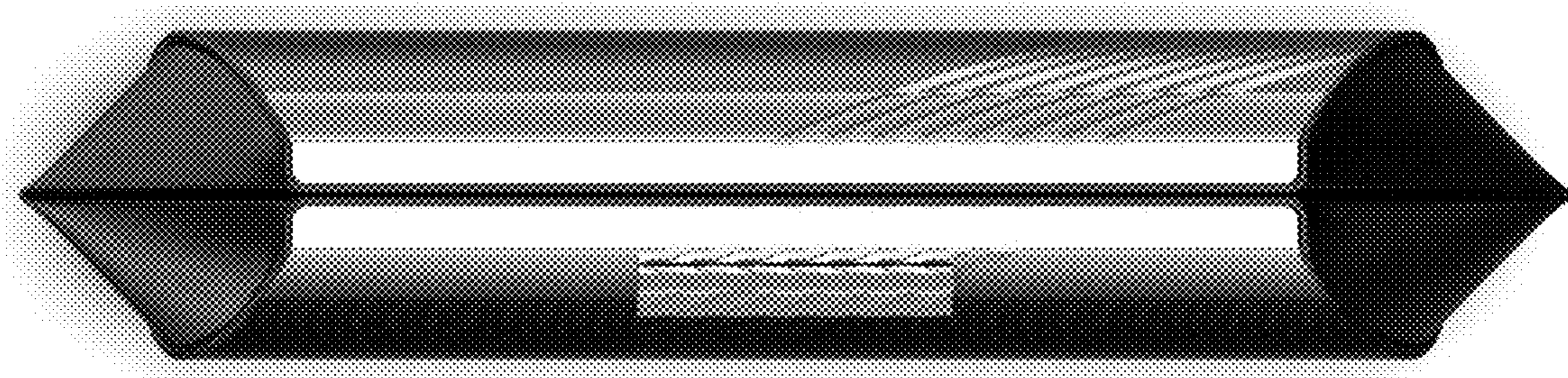

3.4

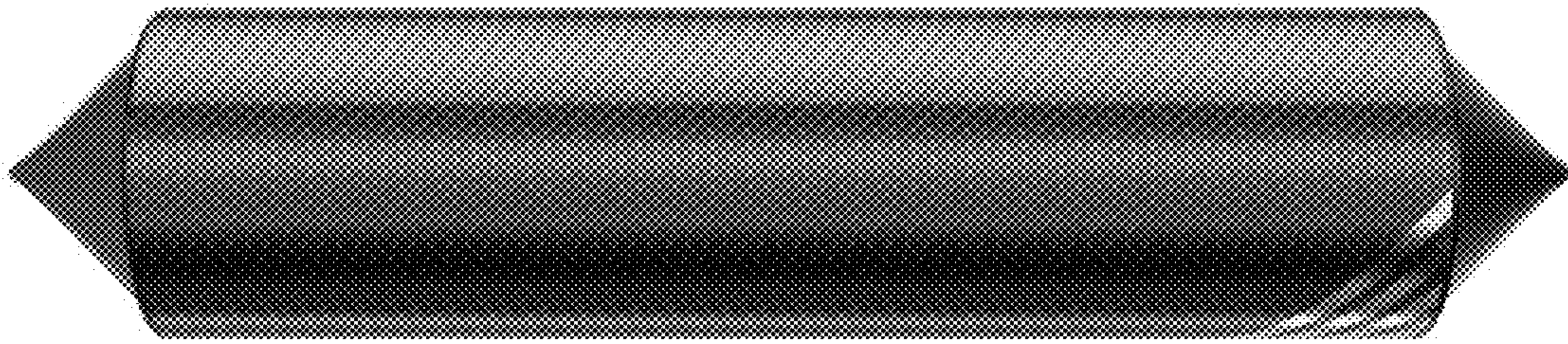



3.5

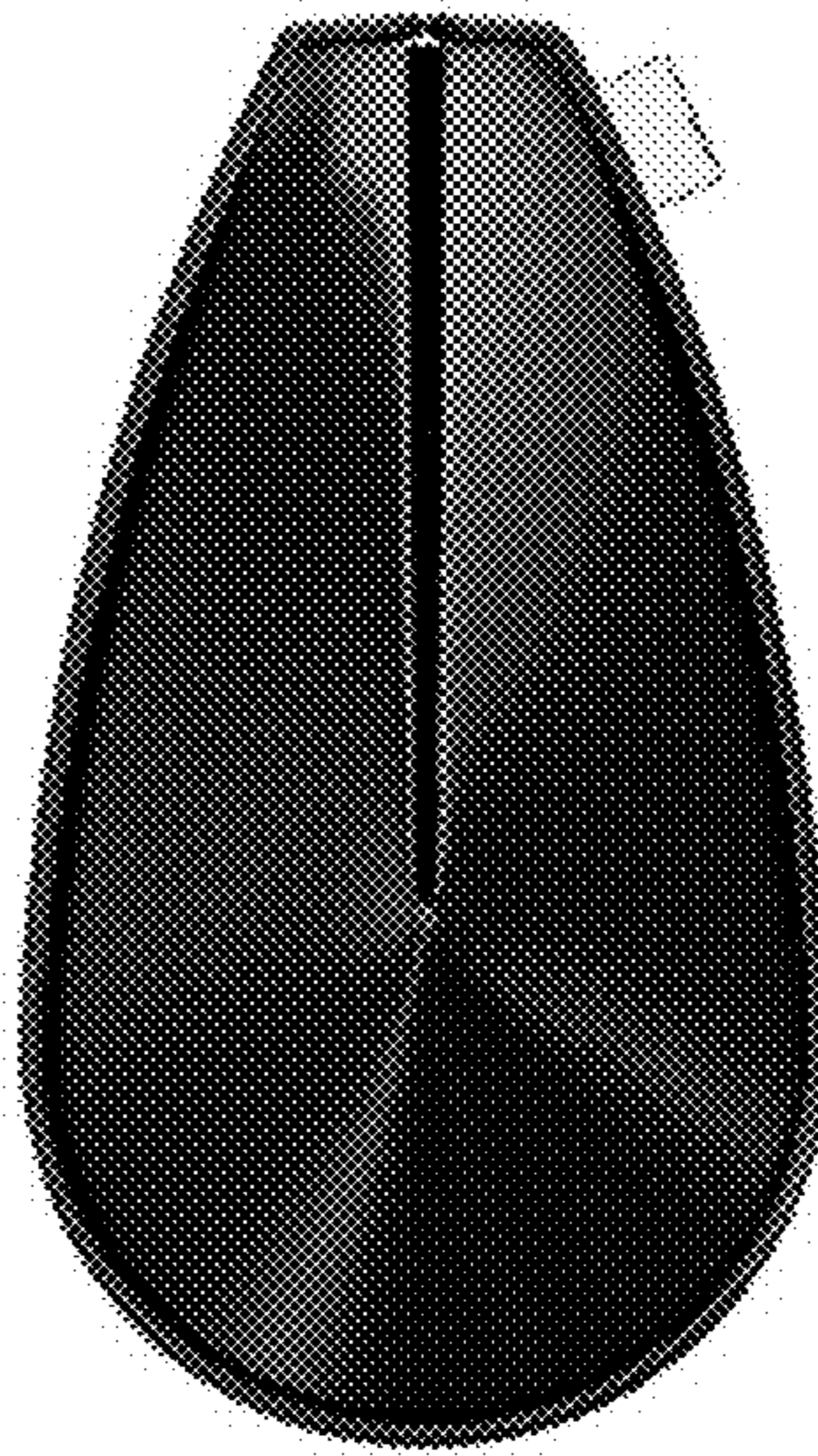

3.6

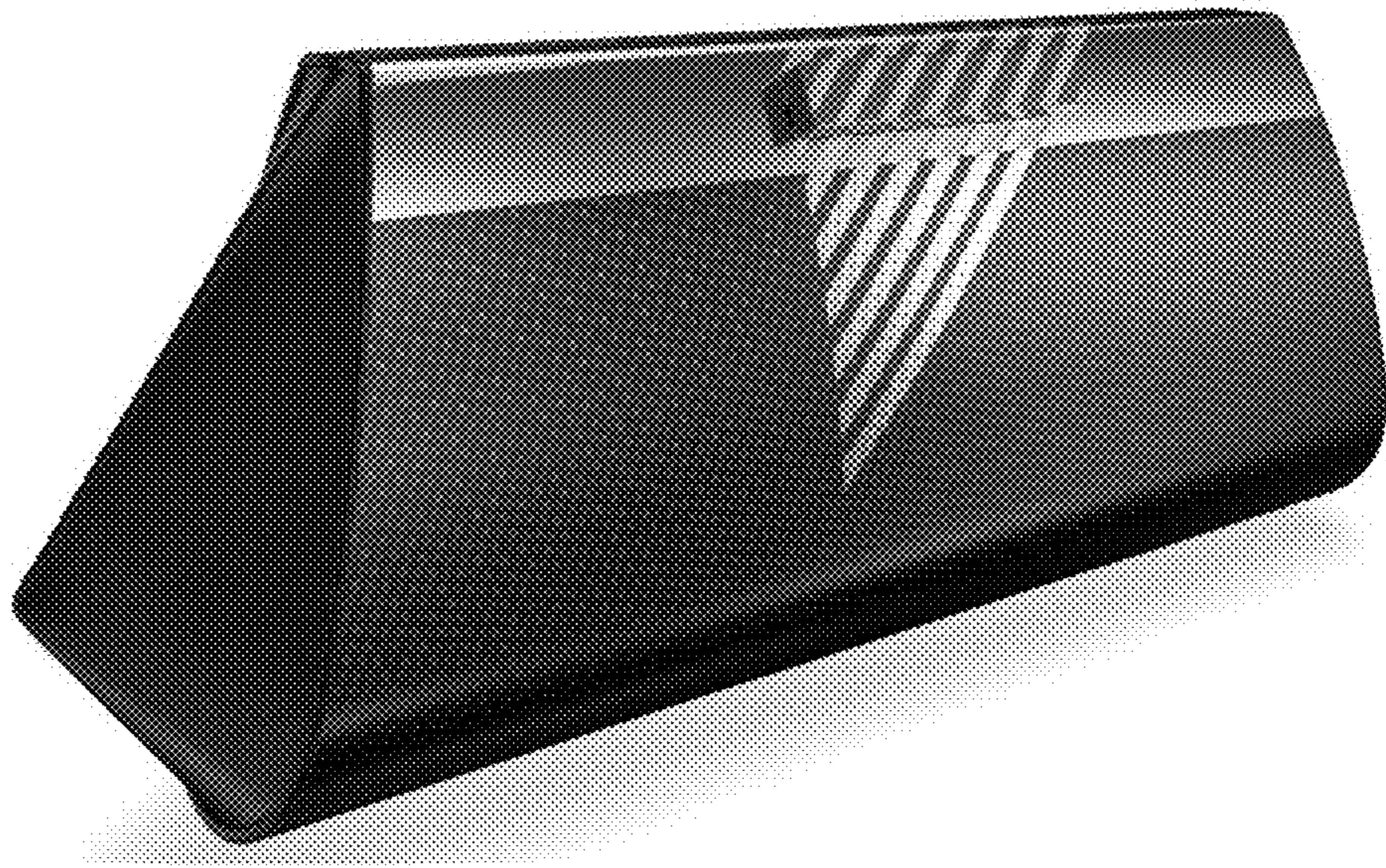

3.7

