



US00D788432S

(12) **United States Design Patent**
MacIntyre

(10) **Patent No.:** **US D788,432 S**

(45) **Date of Patent:** **** Jun. 6, 2017**

- (54) **FOOTWEAR UPPER**
- (71) Applicant: **Deckers Outdoor Corporation**, Goleta, CA (US)
- (72) Inventor: **Jennifer MacIntyre**, Santa Barbara, CA (US)
- (73) Assignee: **Deckers Outdoor Corporation**, Goleta, CA (US)
- (**) Term: **15 Years**
- (21) Appl. No.: **29/564,317**
- (22) Filed: **May 12, 2016**
- (51) **LOC (10) Cl.** **02-04**
- (52) **U.S. Cl.**
USPC **D2/970**
- (58) **Field of Classification Search**
USPC D2/896, 900, 909-911, 943, 946, 969, D2/970, 974; 36/83, 1.5, 2 R, 109, 3 A, 36/7.1 R, 45, 52, 112, 100, 136
CPC A41D 17/00; A41D 17/02; A41D 5/00; A43B 3/16; A43B 23/25; A43B 23/24; A43B 23/00
See application file for complete search history.

- D616,190 S * 5/2010 MacIntyre D2/970
- D646,475 S * 10/2011 Boncutter D2/912
- D704,425 S 5/2014 MacIntyre
- D704,427 S 5/2014 Dillenbeck
- D705,529 S 5/2014 Ng
- D734,935 S 7/2015 Todd
- D738,605 S 9/2015 Dillenbeck et al.
- D755,494 S * 5/2016 Todd D2/910

* cited by examiner

Primary Examiner — Holly Baynham
Assistant Examiner — Rashida C Walshon
(74) *Attorney, Agent, or Firm* — Greer, Burns & Crain, Ltd.

(57) **CLAIM**

The ornamental design for a footwear upper, as shown and described.

DESCRIPTION

FIG. 1 is a perspective view of a footwear upper showing my new design;
FIG. 2 is a side elevational view thereof;
FIG. 3 is an opposite side elevational view thereof;
FIG. 4 is a front elevational view thereof;
FIG. 5 is a rear elevational view thereof;
FIG. 6 is a top plan view thereof; and,
FIG. 7 is a bottom plan view thereof.
The dashed lines represents portions of the footwear that do not form any part of the claimed design. Further, the dash dot dot dash lines immediately adjacent to the solid-line portions of the footwear defines the bounds of the design, and forms no part of the claimed design.

1 Claim, 5 Drawing Sheets

(56) **References Cited**

U.S. PATENT DOCUMENTS

- D76,233 S * 9/1928 Golden D2/900
- D159,761 S * 8/1950 Stromberg D2/910
- D319,332 S * 8/1991 Itzkowitz D2/910
- D539,024 S * 3/2007 Belley D2/970
- D575,495 S * 8/2008 Le D2/970
- D599,999 S 9/2009 MacIntyre

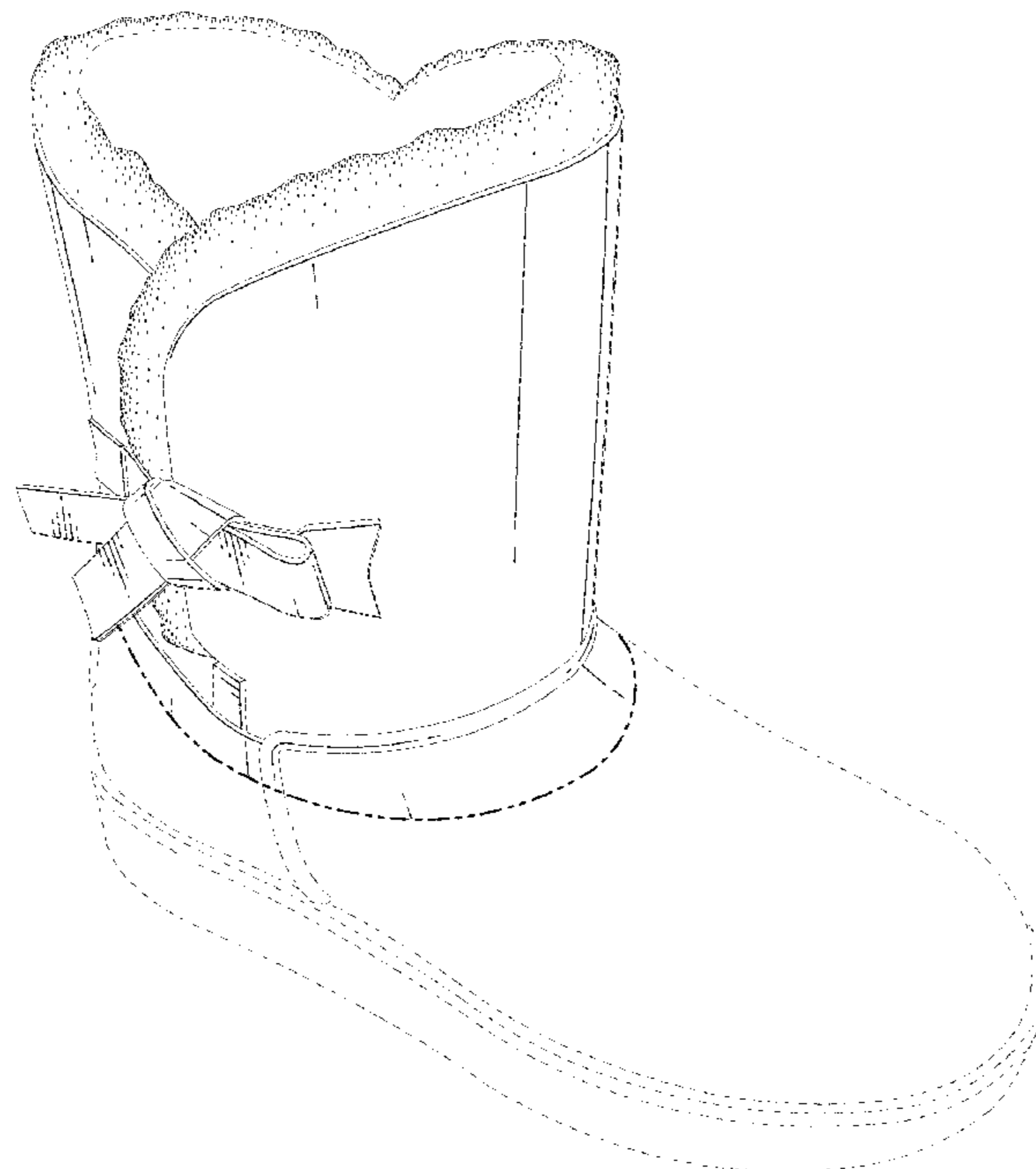

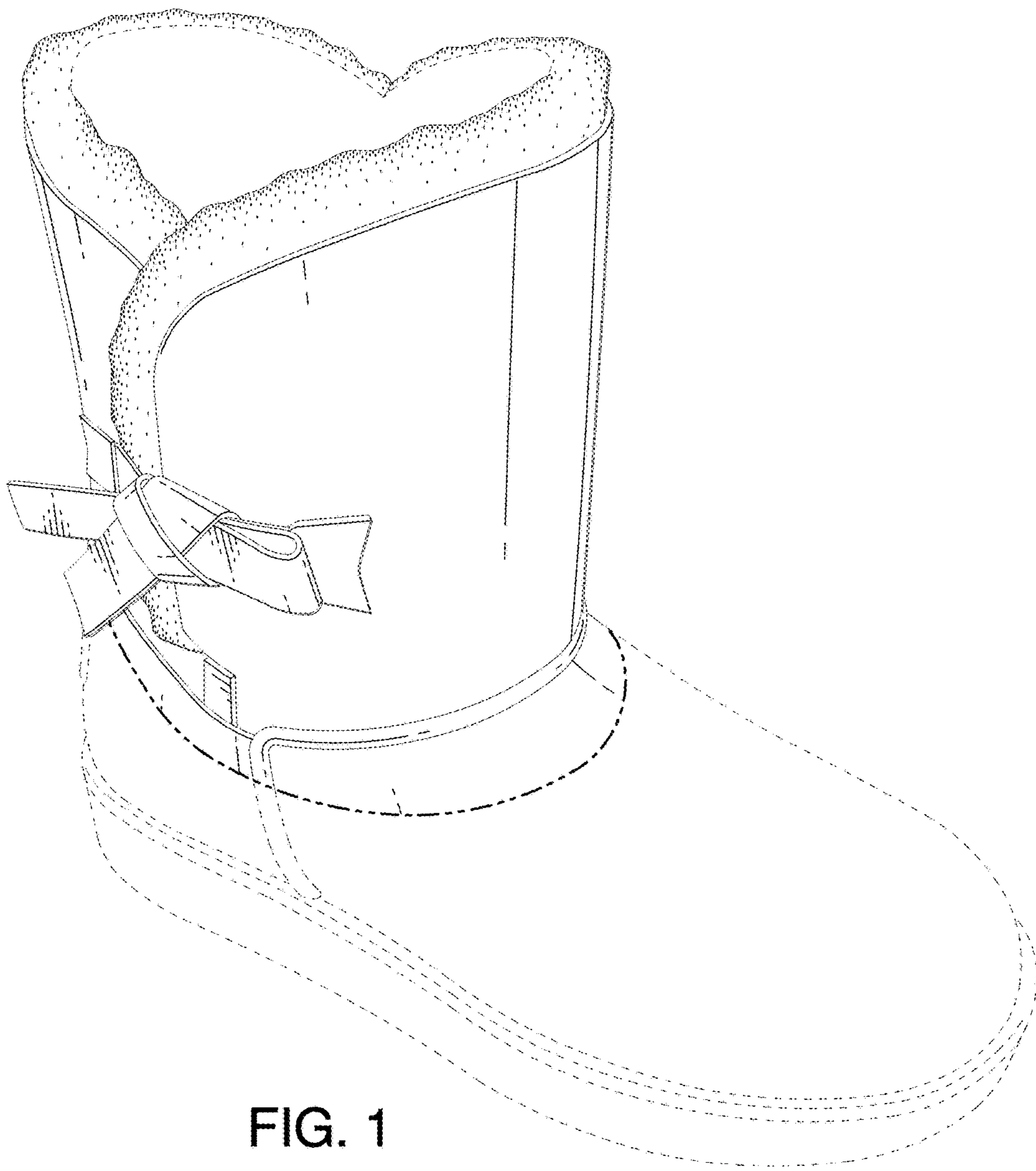

FIG. 1

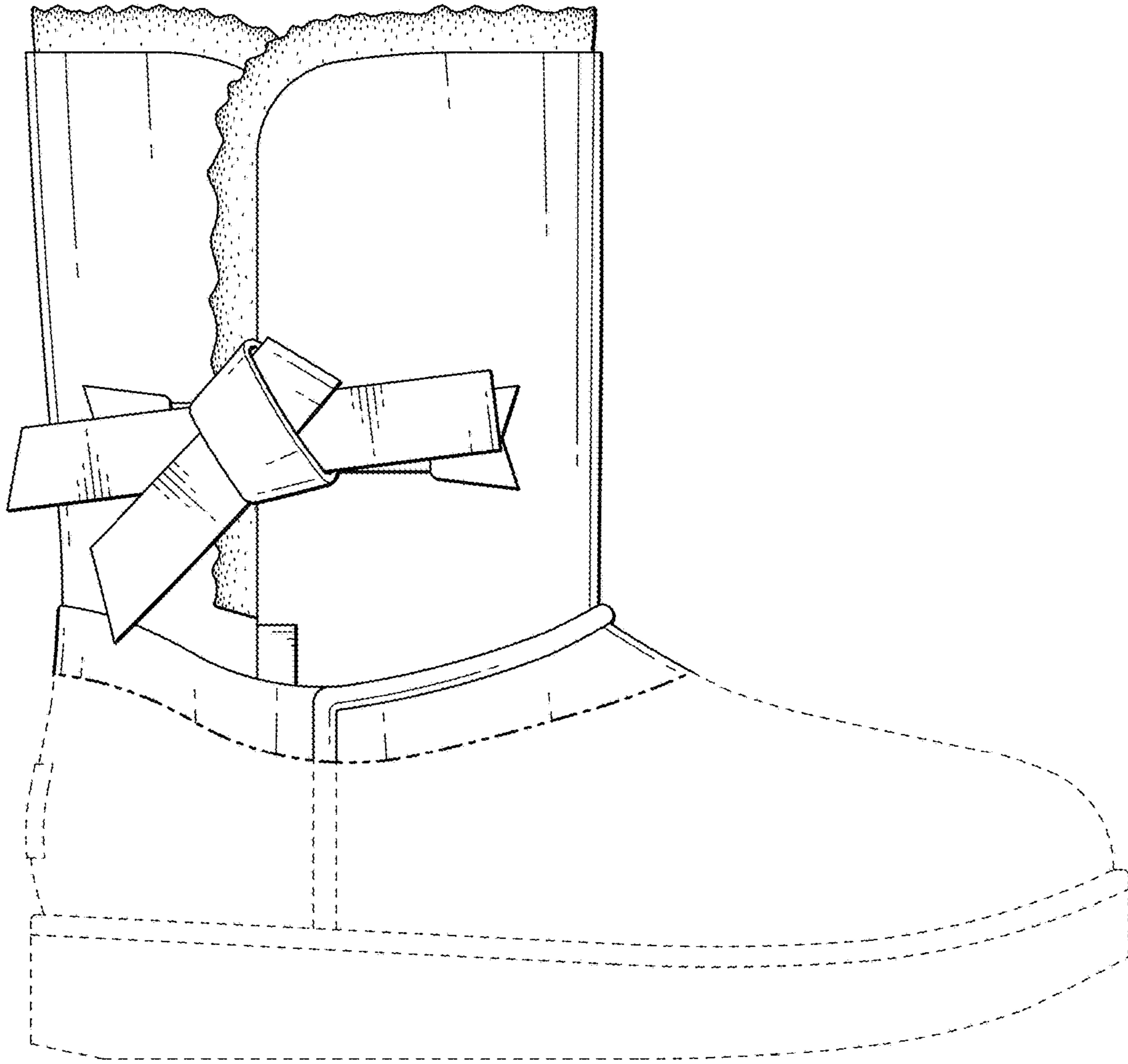

FIG. 2

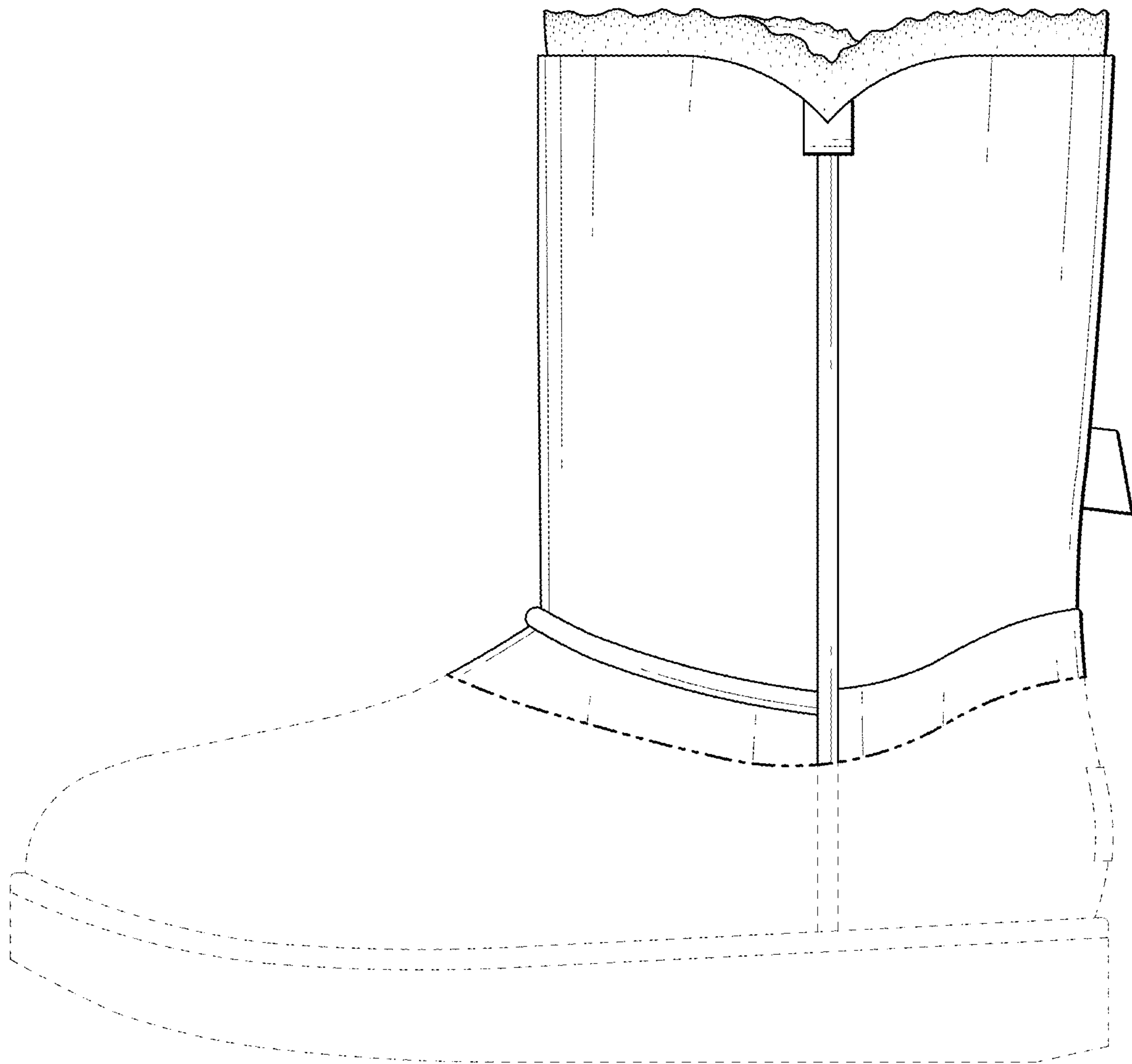

FIG. 3

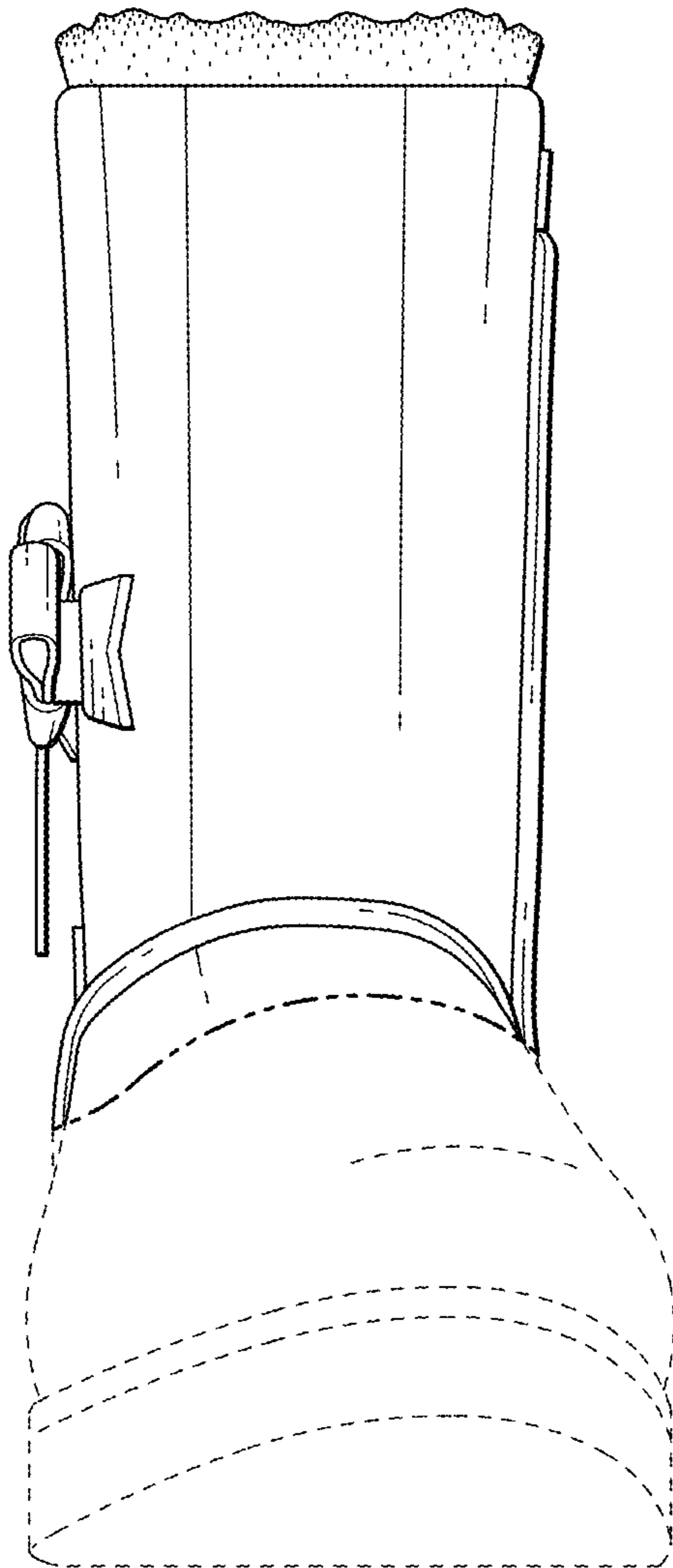

FIG. 4

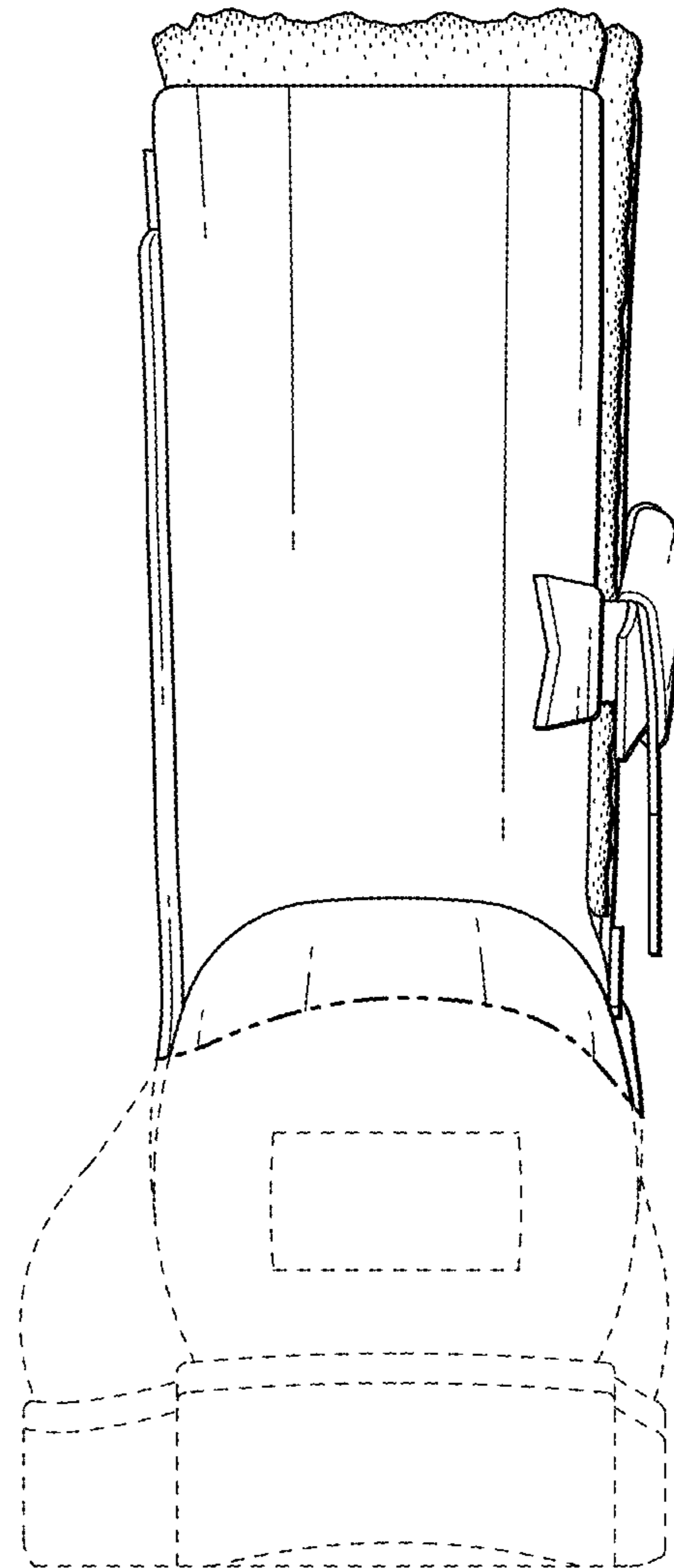

FIG. 5

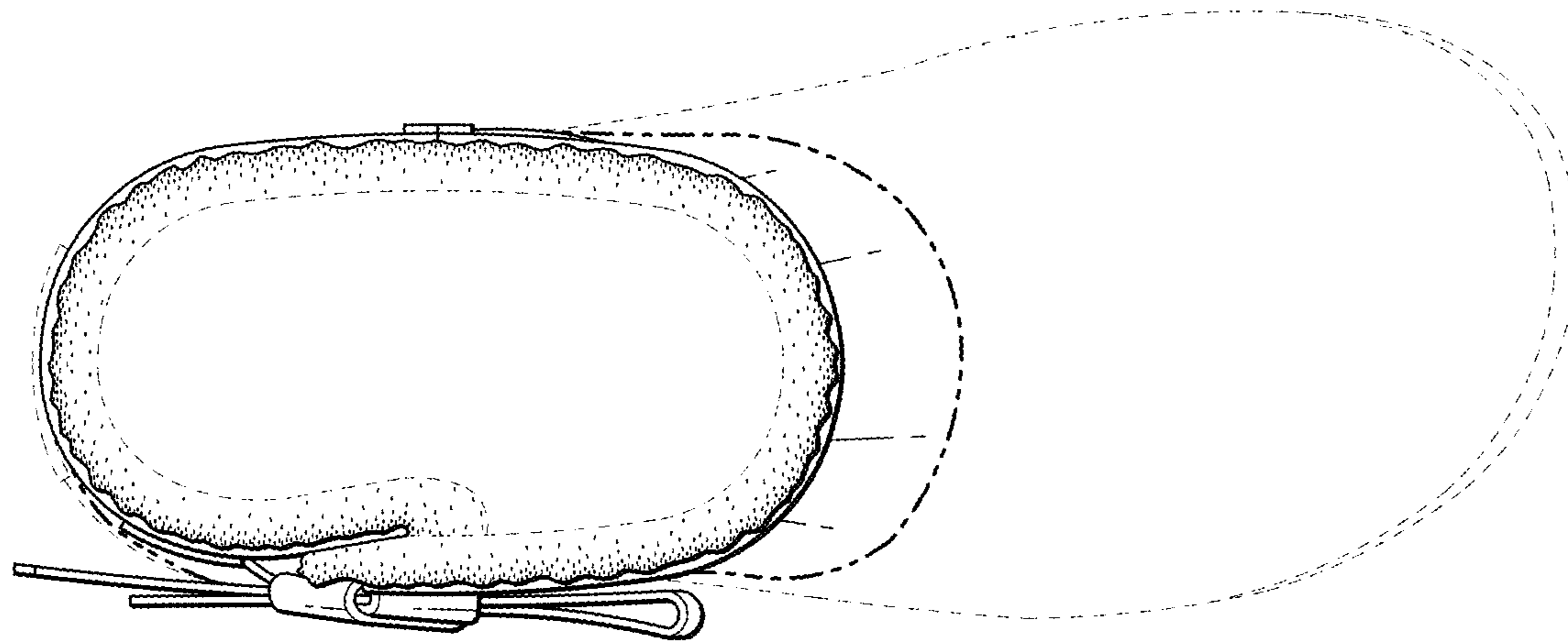

FIG. 6

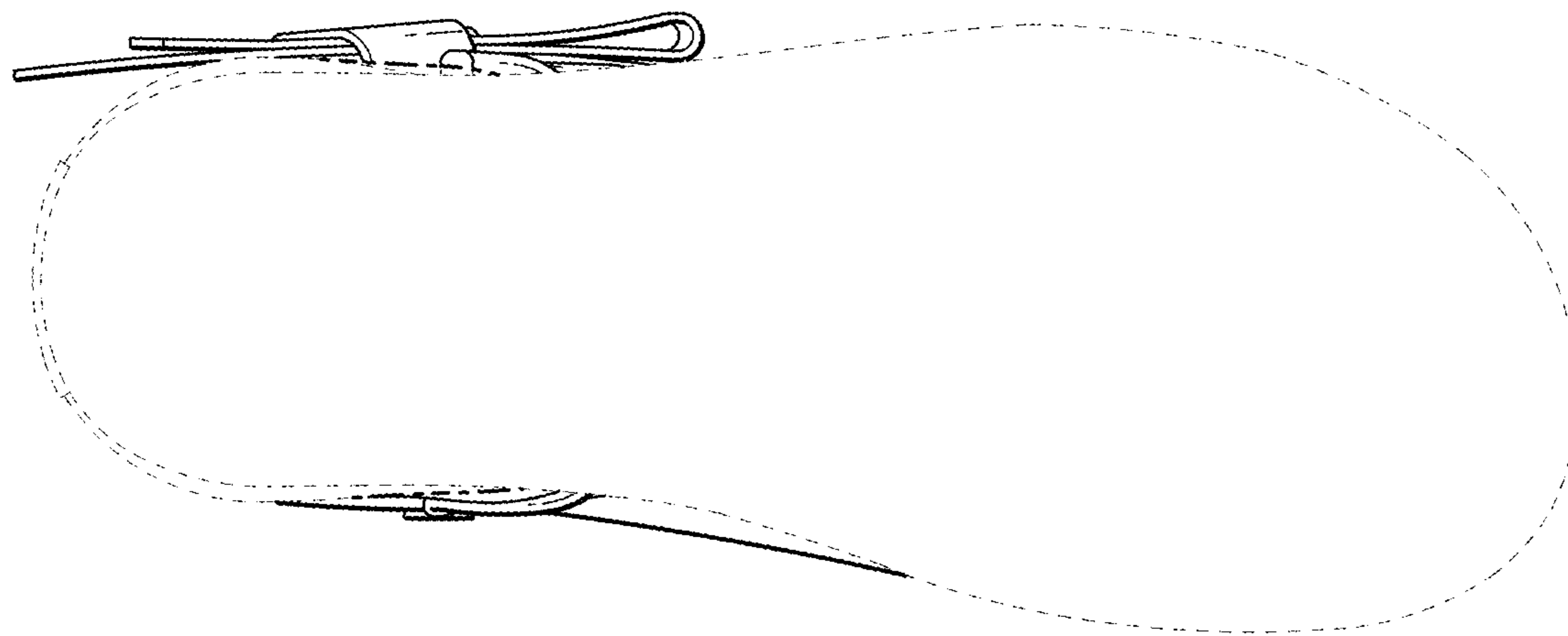

FIG. 7