



US00D787973S

(12) **United States Design Patent** (10) **Patent No.:** **US D787,973 S**
Gaynes et al. (45) **Date of Patent:** **** May 30, 2017**

(54) **TWO STONE SETTING WITH OFFSET**

D672,680 S * 12/2012 Papadimitriou D11/34
D677,597 S * 3/2013 Papadimitriou D11/34
D701,137 S * 3/2014 Dholakiya D11/34

(71) Applicant: **SIGNET GROUP SERVICES US INC.**, Akron, OH (US)

(72) Inventors: **David Gaynes**, Cliffside Park, NJ (US); **Anne M. Rush**, Fort Lee, NJ (US)

(73) Assignee: **SIGNET GROUP SERVICES US INC.**, Akron, OH (US)

(**) Term: **15 Years**

(21) Appl. No.: **29/540,676**

(22) Filed: **Sep. 25, 2015**

(51) **LOC (10) Cl.** **11-01**

(52) **U.S. Cl.**
USPC **D11/34**

(58) **Field of Classification Search**
USPC D11/1-5, 26-39, 91-92; 63/15-15.4
CPC .. A44C 9/00; A44C 9/02; A44C 27/00; A44C 17/02; A44C 17/04; A44C 5/00; A44C 15/002; A44C 17/00
See application file for complete search history.

(56) **References Cited**

U.S. PATENT DOCUMENTS

D166,978 S * 6/1952 Katz D11/5
D354,697 S * 1/1995 Andrau D11/28
D466,040 S * 11/2002 Turner D11/35
D660,742 S * 5/2012 Papadimitriou D11/34
D661,218 S * 6/2012 Papadimitriou D11/34

OTHER PUBLICATIONS

Photographs of two stone ring settings (7 pp.) (available at least as early as Sep. 25, 2015).

* cited by examiner

Primary Examiner — Ralf Seifert

(74) *Attorney, Agent, or Firm* — Holland & Hart LLP

(57) **CLAIM**

The ornamental design for a two stone setting with offset, as shown and described.

DESCRIPTION

FIG. 1 is a top perspective view of a two stone setting with offset according to the present invention;
FIG. 2 is a bottom perspective view thereof;
FIG. 3 is a front view thereof;
FIG. 4 is a rear side view thereof;
FIG. 5 is a right side view thereof;
FIG. 6 is a left side view thereof;
FIG. 7 is a top view thereof; and,
FIG. 8 is a bottom view thereof.

The broken lines shown in the figures illustrate unclaimed portions of the design.

1 Claim, 8 Drawing Sheets

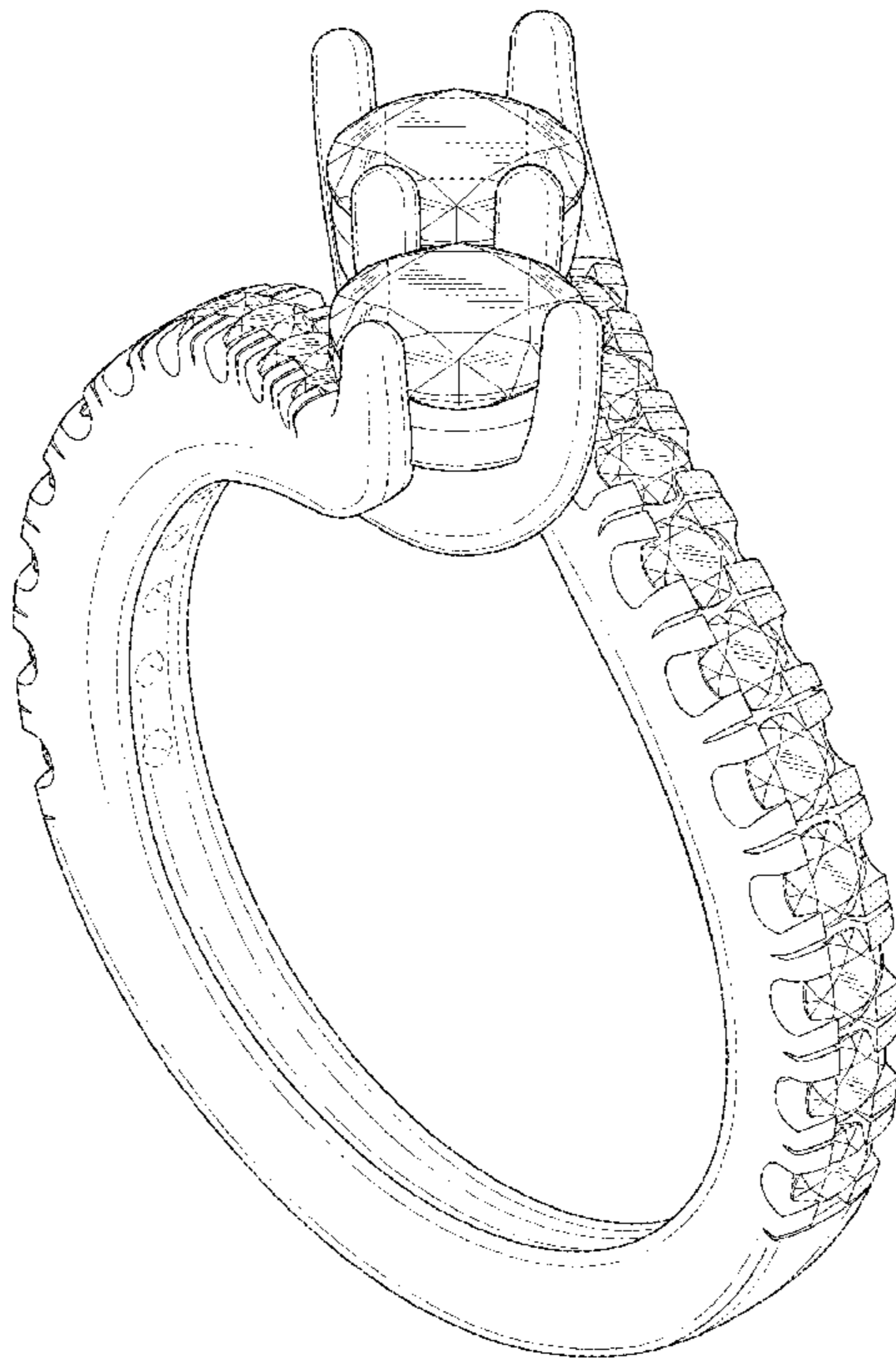

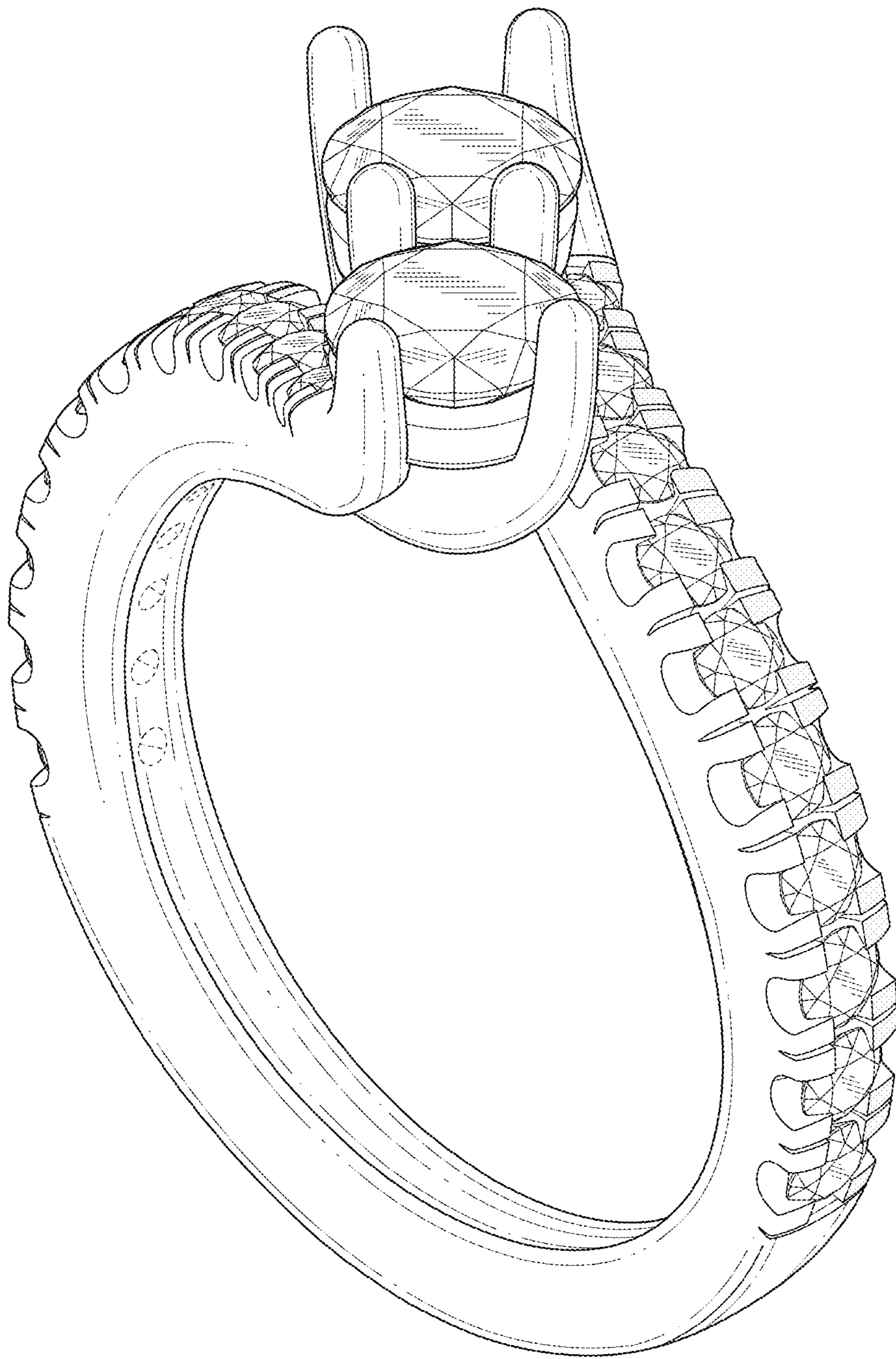

FIG. 1

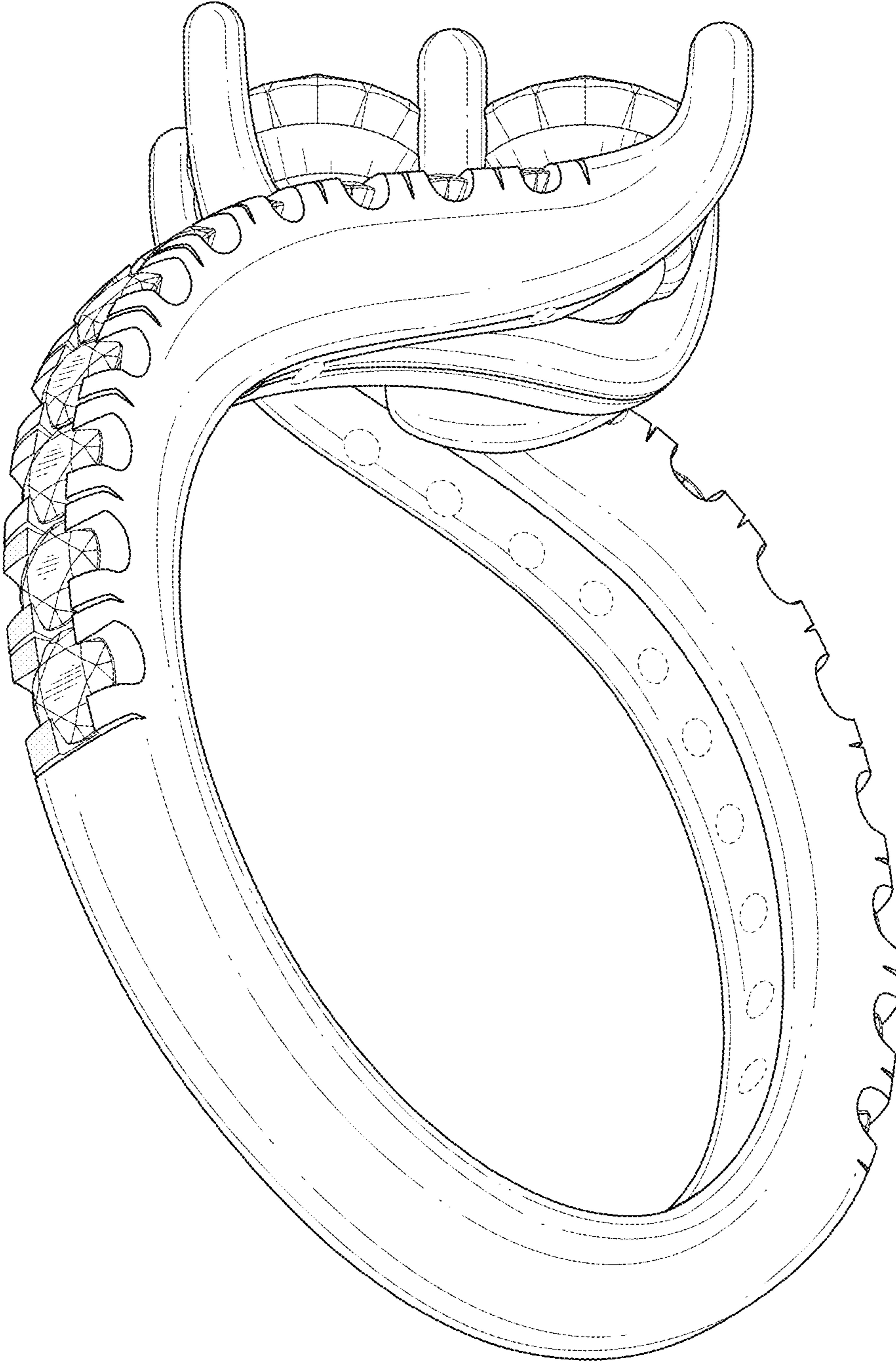

FIG. 2



FIG. 3



FIG. 4

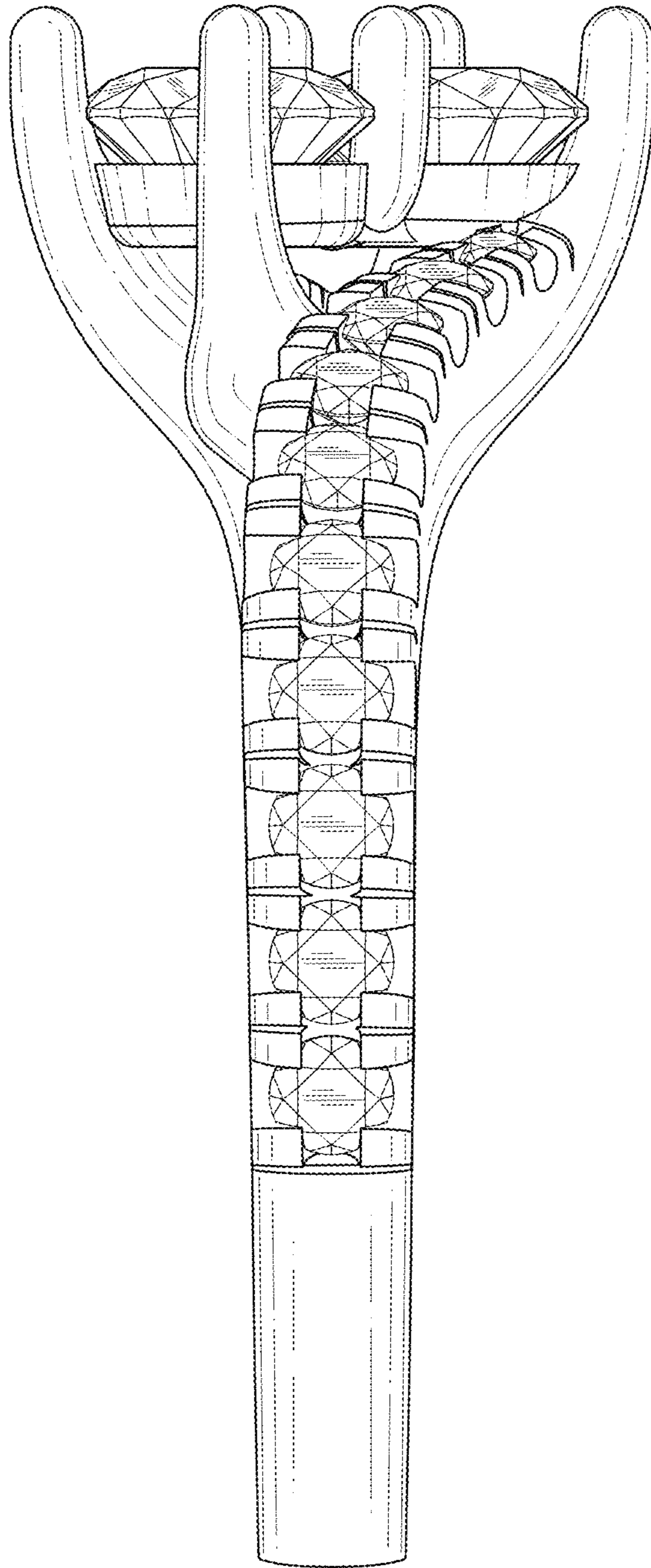

FIG. 5

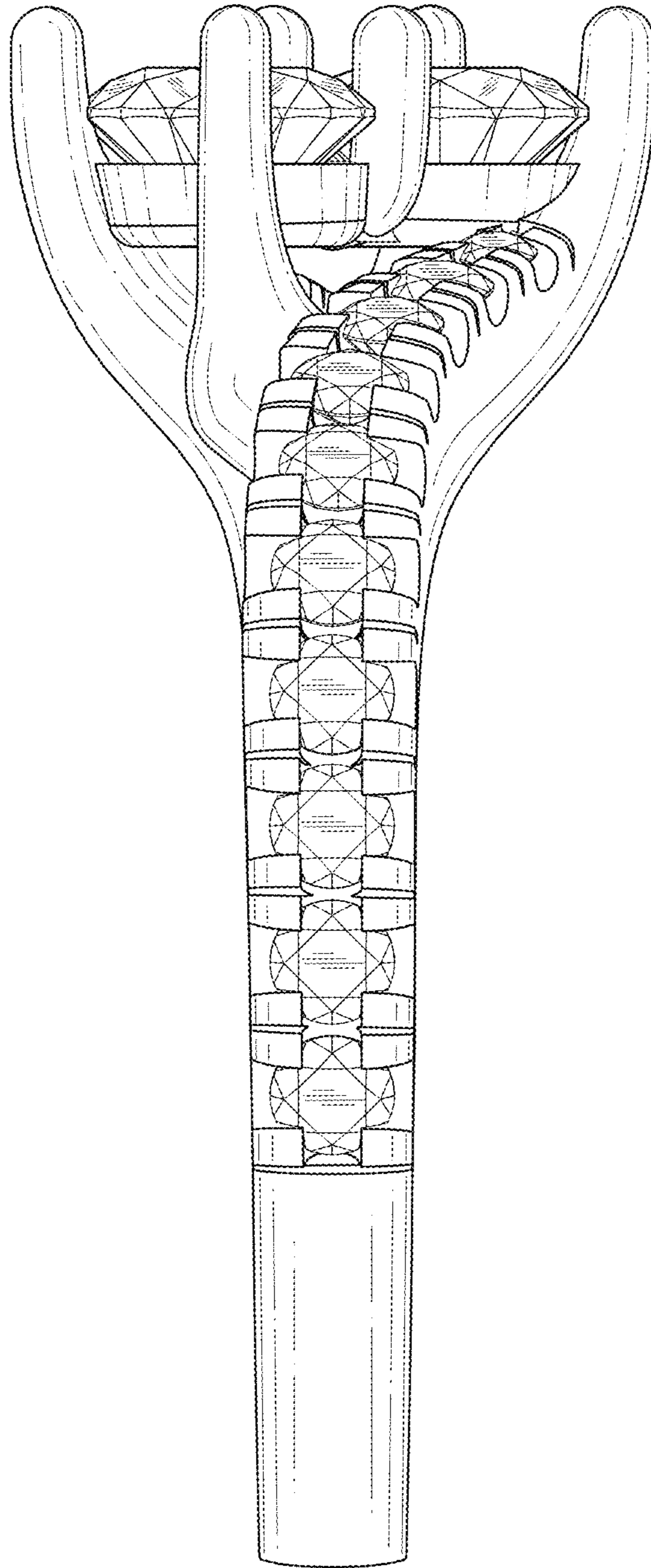

FIG. 6

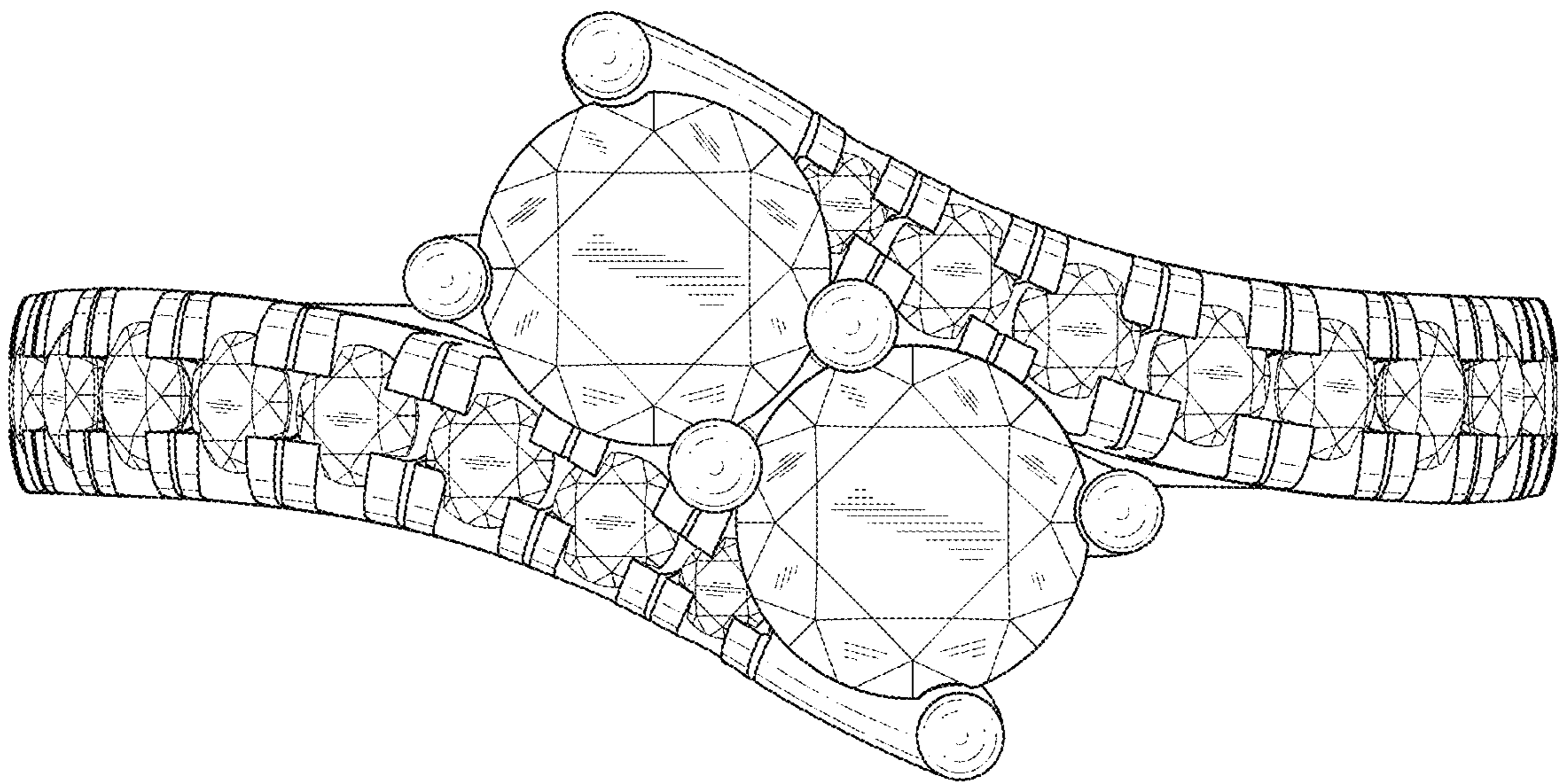

FIG. 7

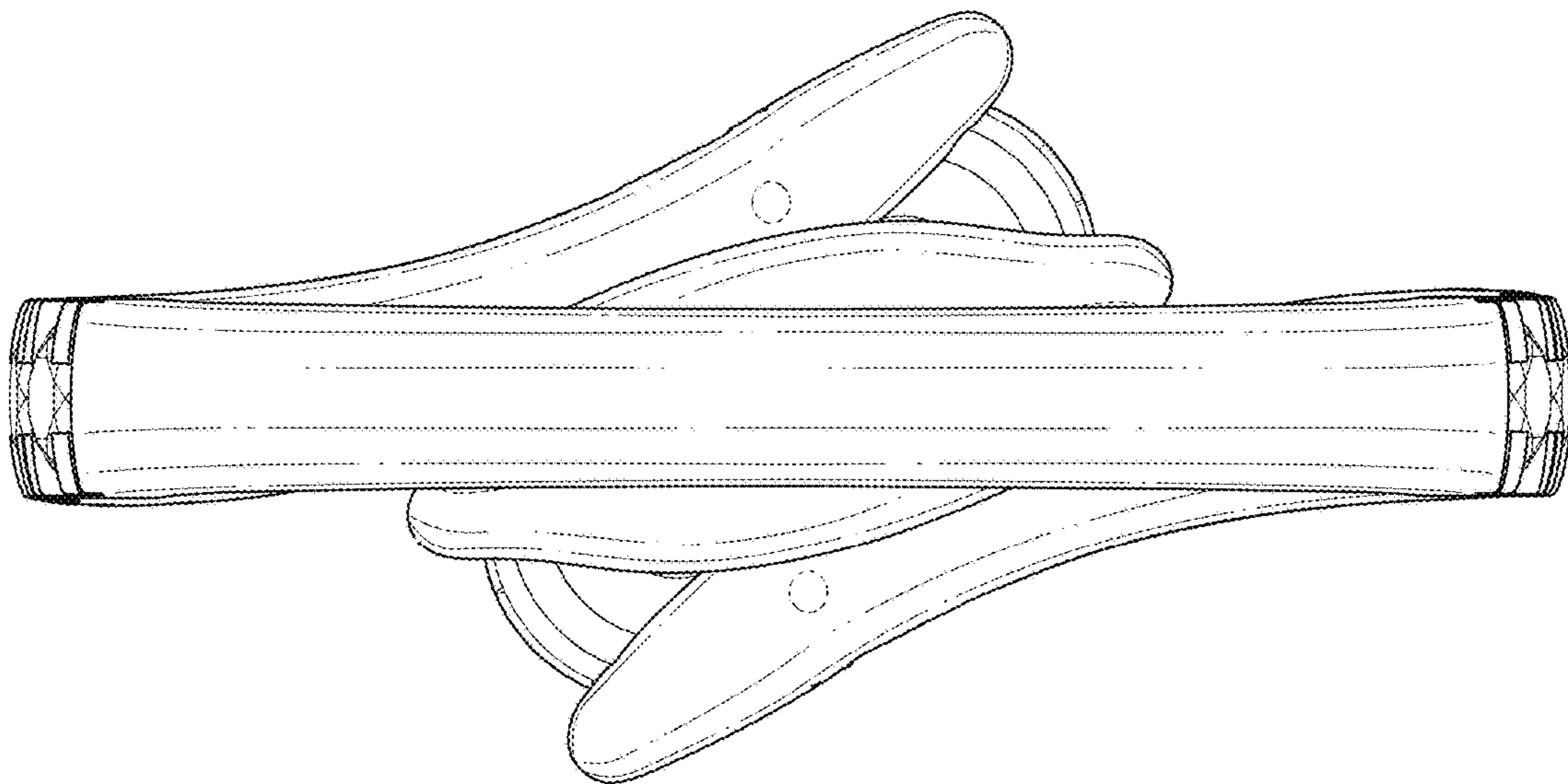

FIG. 8