



US00D787941S

(12) **United States Design Patent** (10) **Patent No.:** **US D787,941 S**
Bos (45) **Date of Patent:** **** May 30, 2017**

- (54) **BOTTLE**
- (71) Applicant: **Reckitt Benckiser (Brands) Limited**,
Slough, Berkshire (GB)
- (72) Inventor: **Randy Bos**, Eindhoven (NL)
- (73) Assignee: **Reckitt Benckiser (Brands) Limited**,
Slough, Berkshire (GB)
- (**) Term: **15 Years**
- (21) Appl. No.: **29/554,164**
- (22) Filed: **Feb. 9, 2016**
- (30) **Foreign Application Priority Data**
Aug. 13, 2015 (EM) 002753970
- (51) **LOC (10) Cl.** **09-01**
- (52) **U.S. Cl.**
USPC **D9/528; D9/575**
- (58) **Field of Classification Search**
USPC D9/516, 530, 531, 533, 572, 575, 715,
D9/745, 523, 528
CPC . B65D 85/00; B65D 1/12; B65D 1/18; B65D
1/20; B65D 21/0237
See application file for complete search history.

- (56) **References Cited**
U.S. PATENT DOCUMENTS
D394,811 S * 6/1998 Jagielski D9/528
D427,914 S * 7/2000 Croft D9/542
D462,616 S * 9/2002 Scheida D9/520
D474,113 S * 5/2003 Hansen B65D 1/0223
D9/531
D545,681 S * 7/2007 Cardinal D9/528
D576,045 S * 9/2008 LeVasseur D9/531

- D578,006 S * 10/2008 Houck D9/531
- D582,776 S * 12/2008 Cardinal D9/528
- D620,365 S * 7/2010 Desjardins D9/528
- D621,713 S * 8/2010 Wilkum D9/528
- D632,579 S * 2/2011 Mayers D9/531
- D644,528 S * 9/2011 Dorn D9/528
- D649,882 S * 12/2011 Fleischhacker D9/516
- D657,681 S * 4/2012 Manderfield, Jr. D9/528
- D684,061 S * 6/2013 Leslie D9/528
- D685,642 S * 7/2013 Leslie D9/528
- D687,305 S * 8/2013 Juna D9/528
- D696,589 S * 12/2013 Soller D9/528
- D747,968 S * 1/2016 Martin D9/453
- D770,294 S * 11/2016 Santoro D9/520

* cited by examiner

Primary Examiner — Ian Simmons
Assistant Examiner — Keith Frank
(74) *Attorney, Agent, or Firm* — Norris McLaughlin & Marcus PA

(57) **CLAIM**

The ornamental design for the bottle, as shown and described.

DESCRIPTION

FIG. 1 is a top side front perspective view of the bottle according to my new design;
FIG. 2 is a plan view of a side of the bottle;
FIG. 3 is plan view of another side of the bottle;
FIG. 4 is a plan view of a further side of the bottle;
FIG. 5 is a plan view of another side of the bottle;
FIG. 6 is a plan view of the top of the bottle; and,
FIG. 7 is a plan view of the bottom of the bottle.
The broken line showing of a portion of the bottle with cap is included for the purpose of illustrating portions of the article and forms no part of the claimed design.

1 Claim, 5 Drawing Sheets

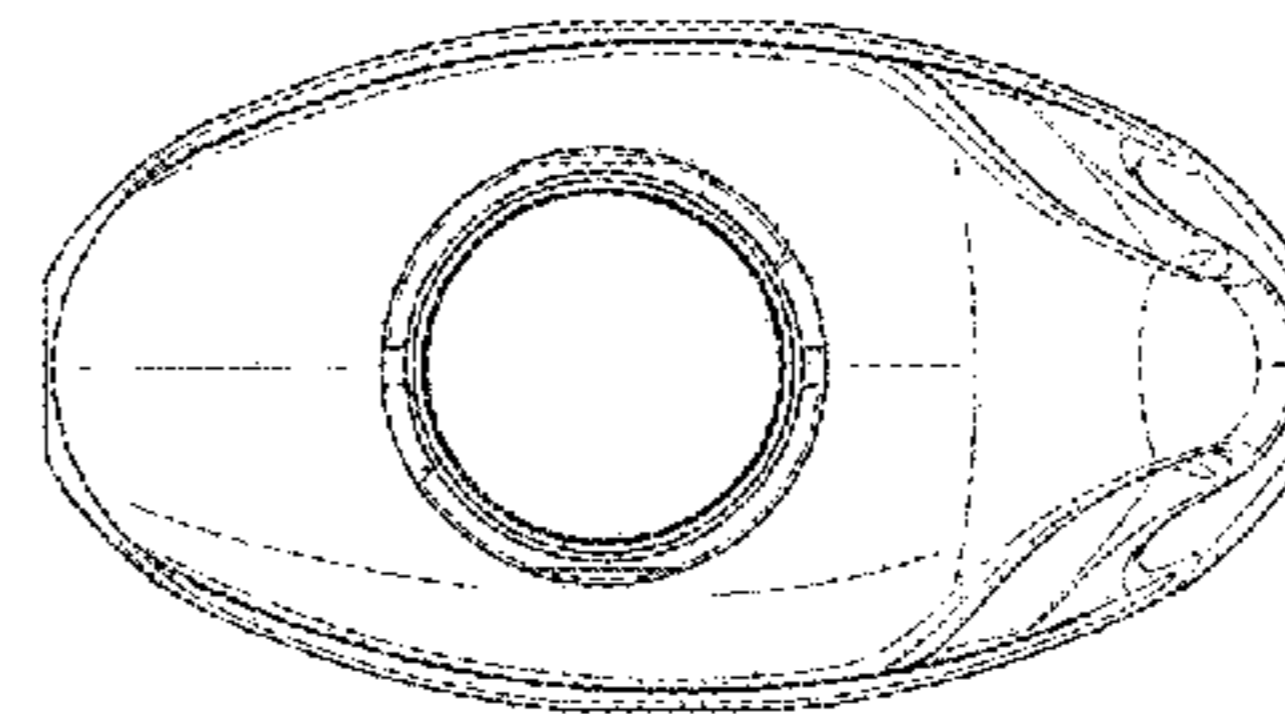
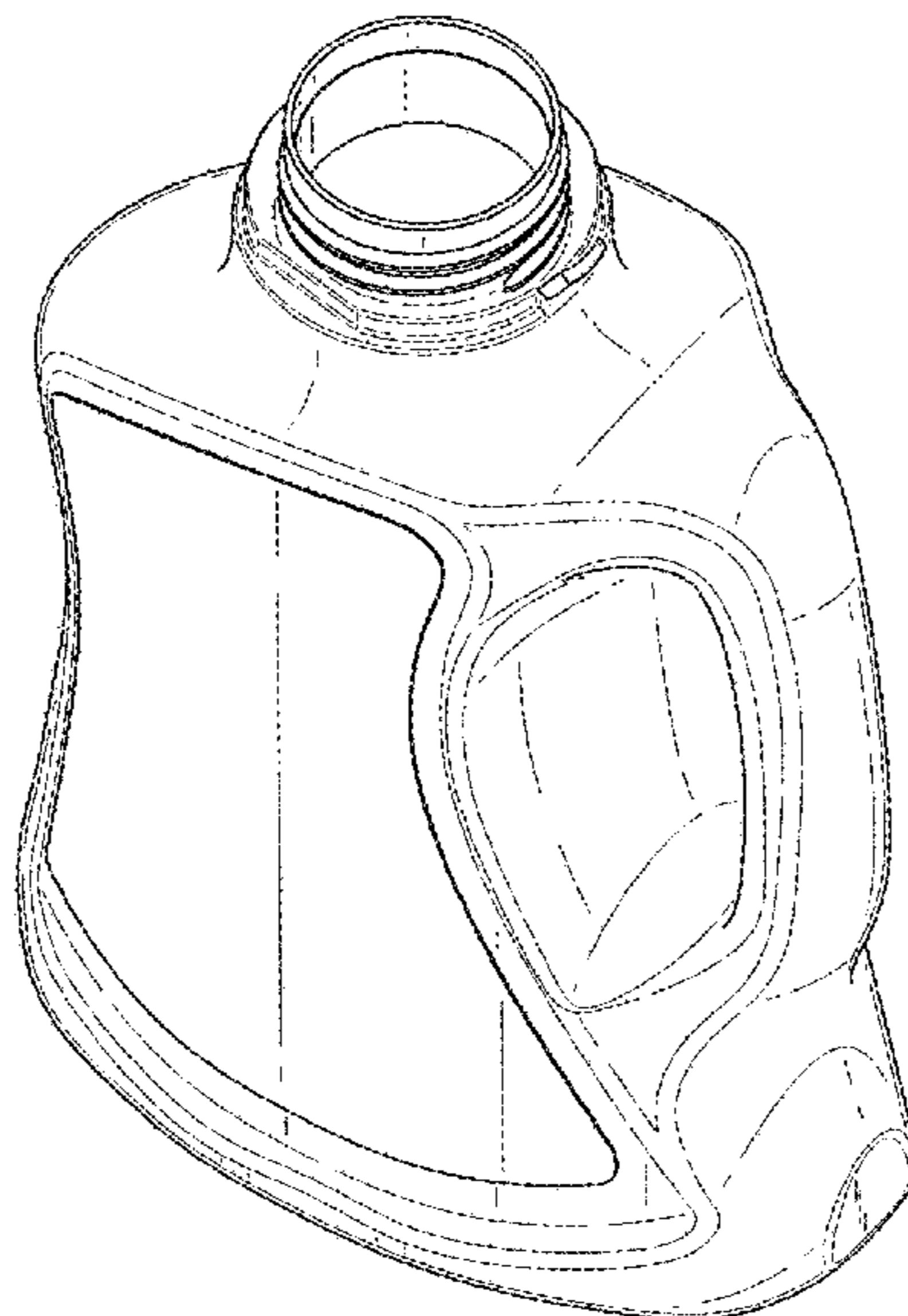

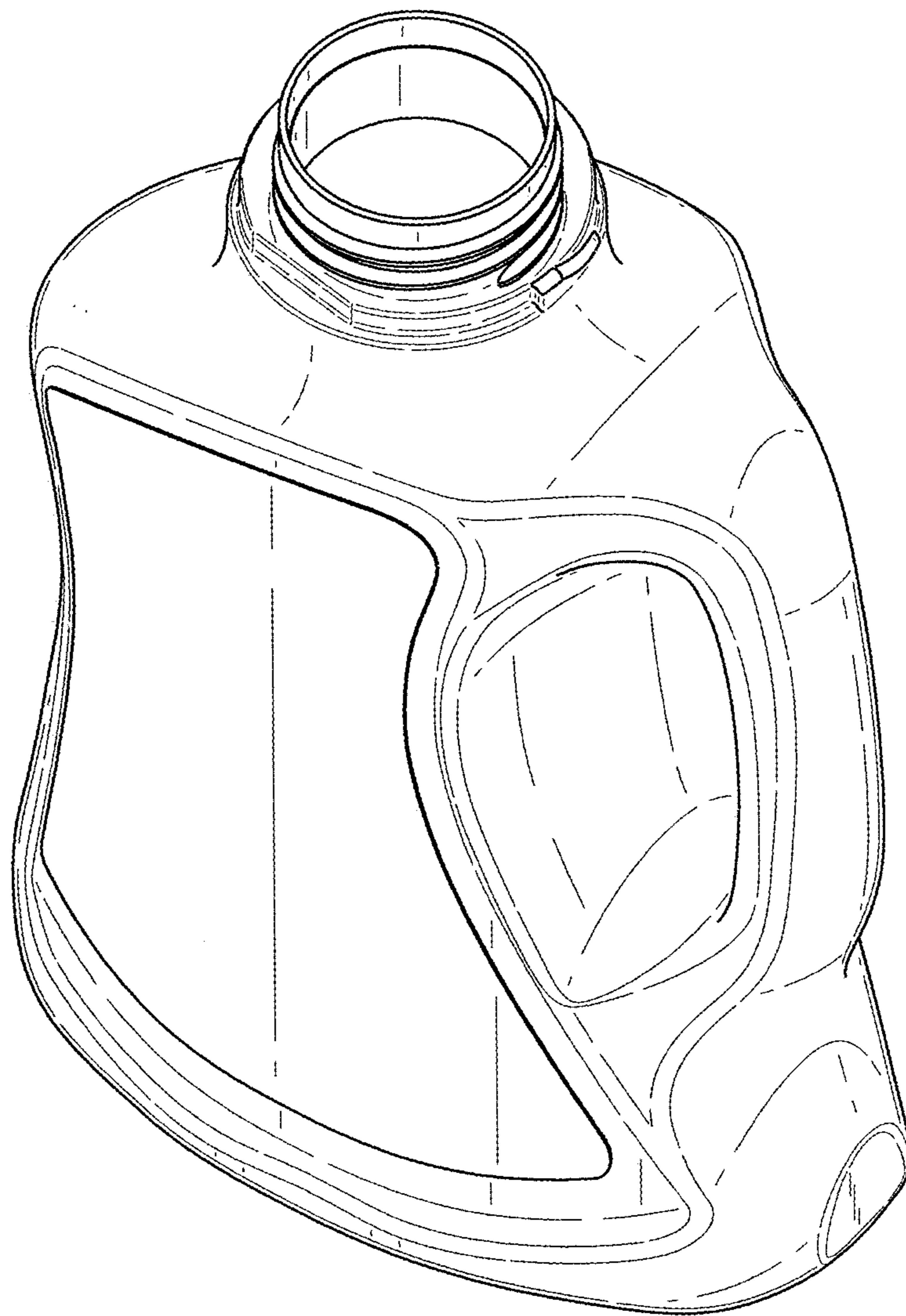

Fig. 1

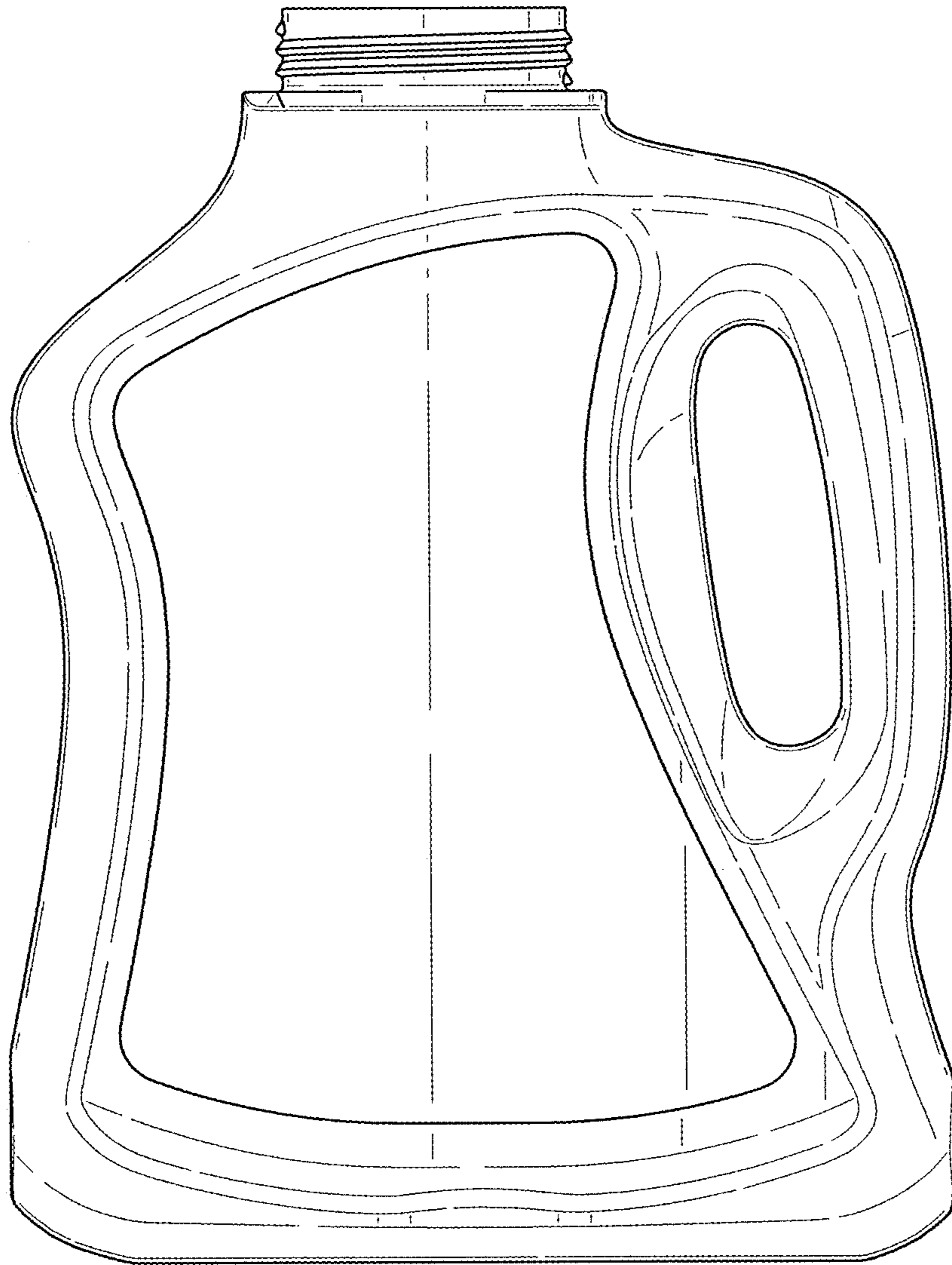

Fig. 2

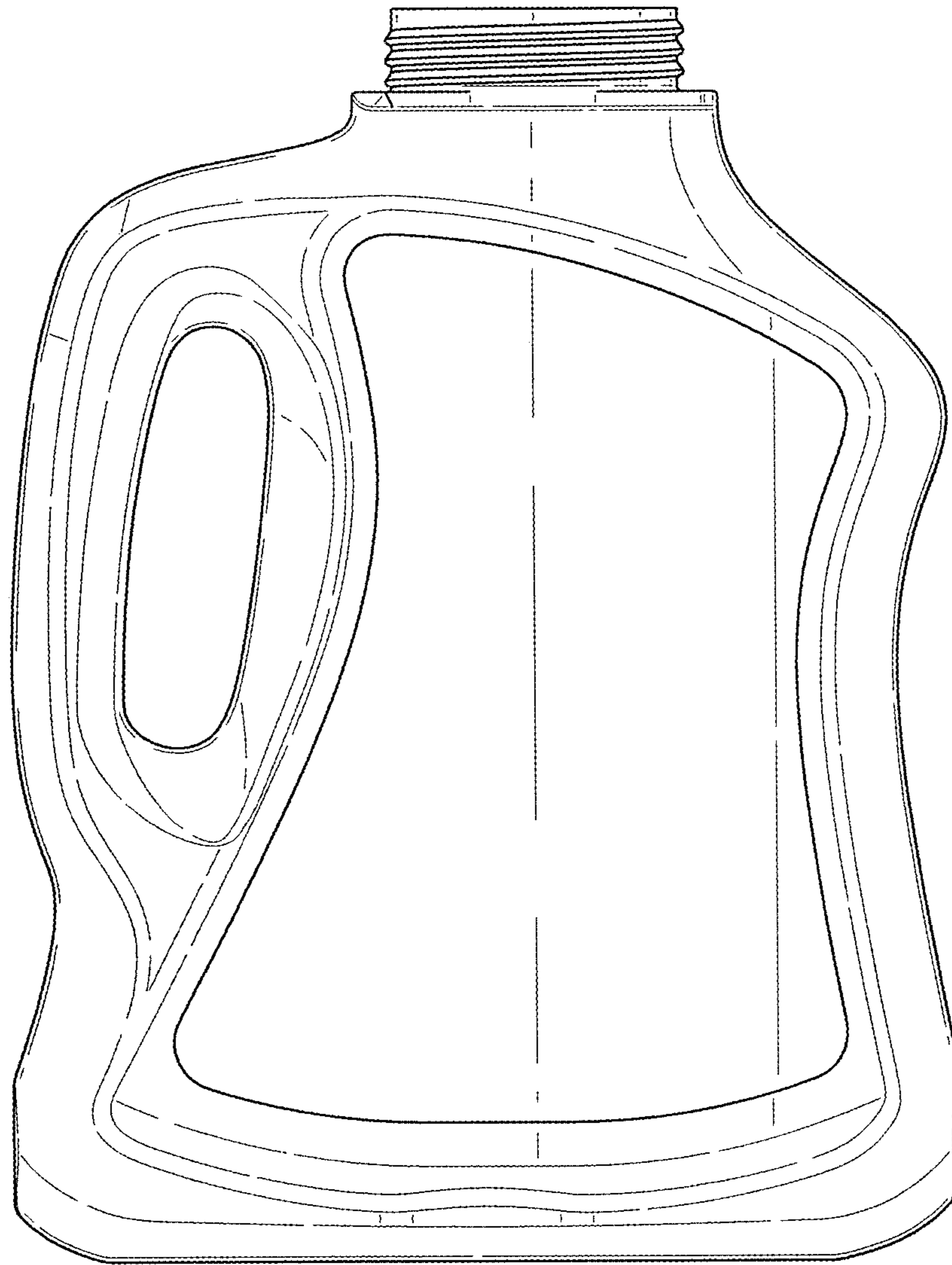

Fig. 3

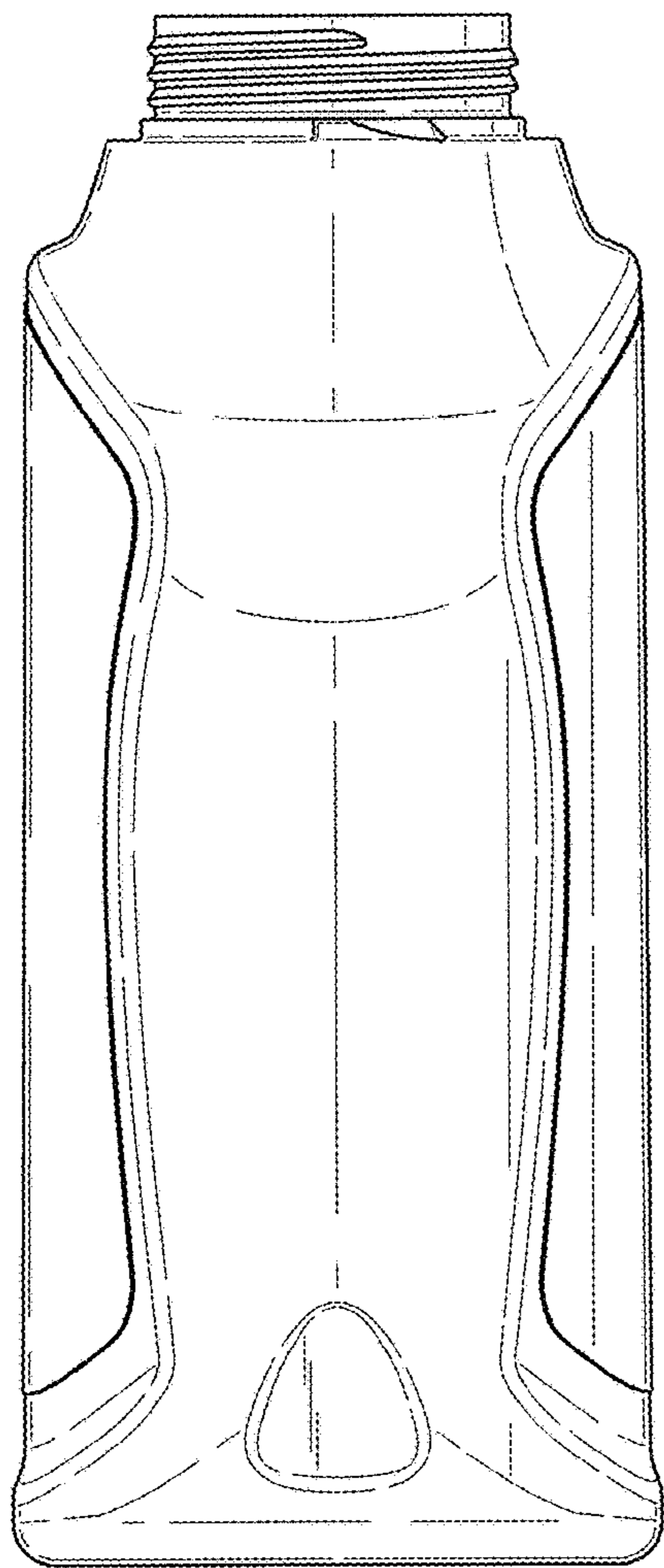

Fig. 4

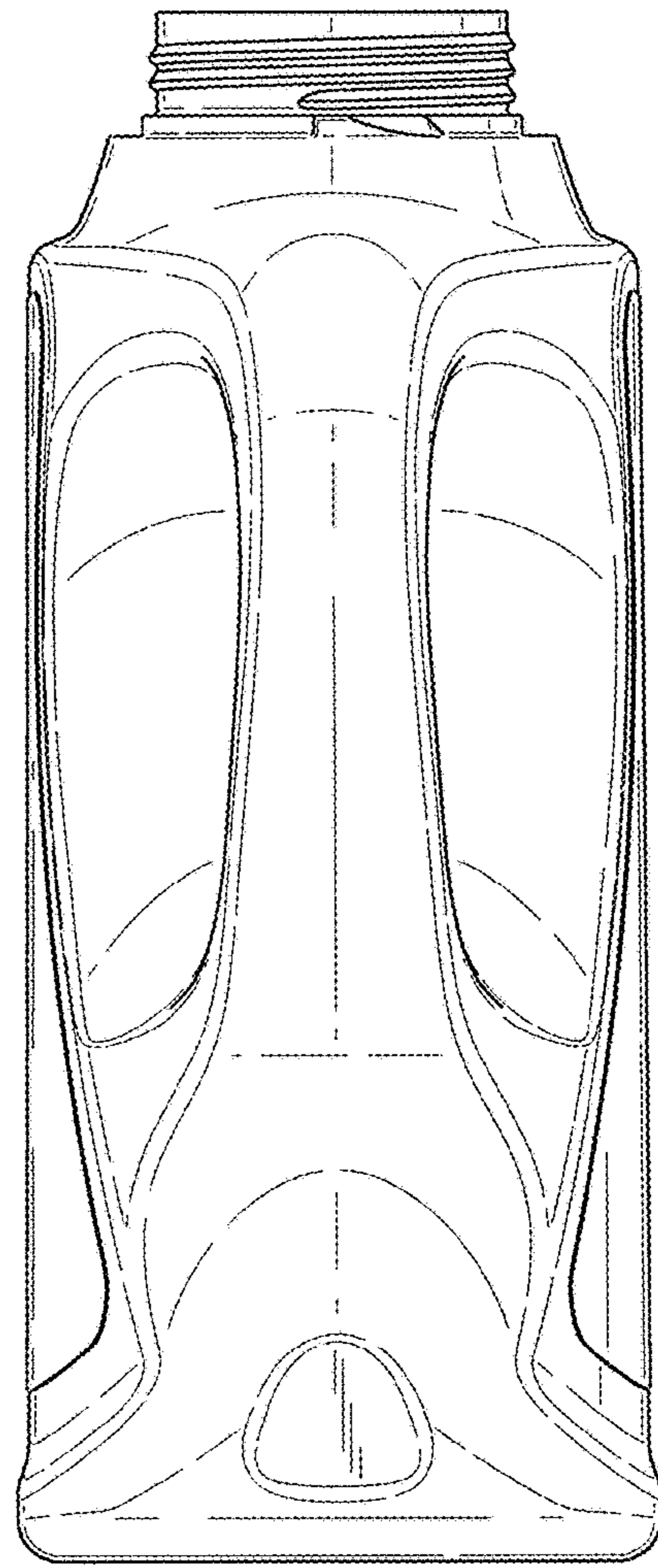

Fig. 5

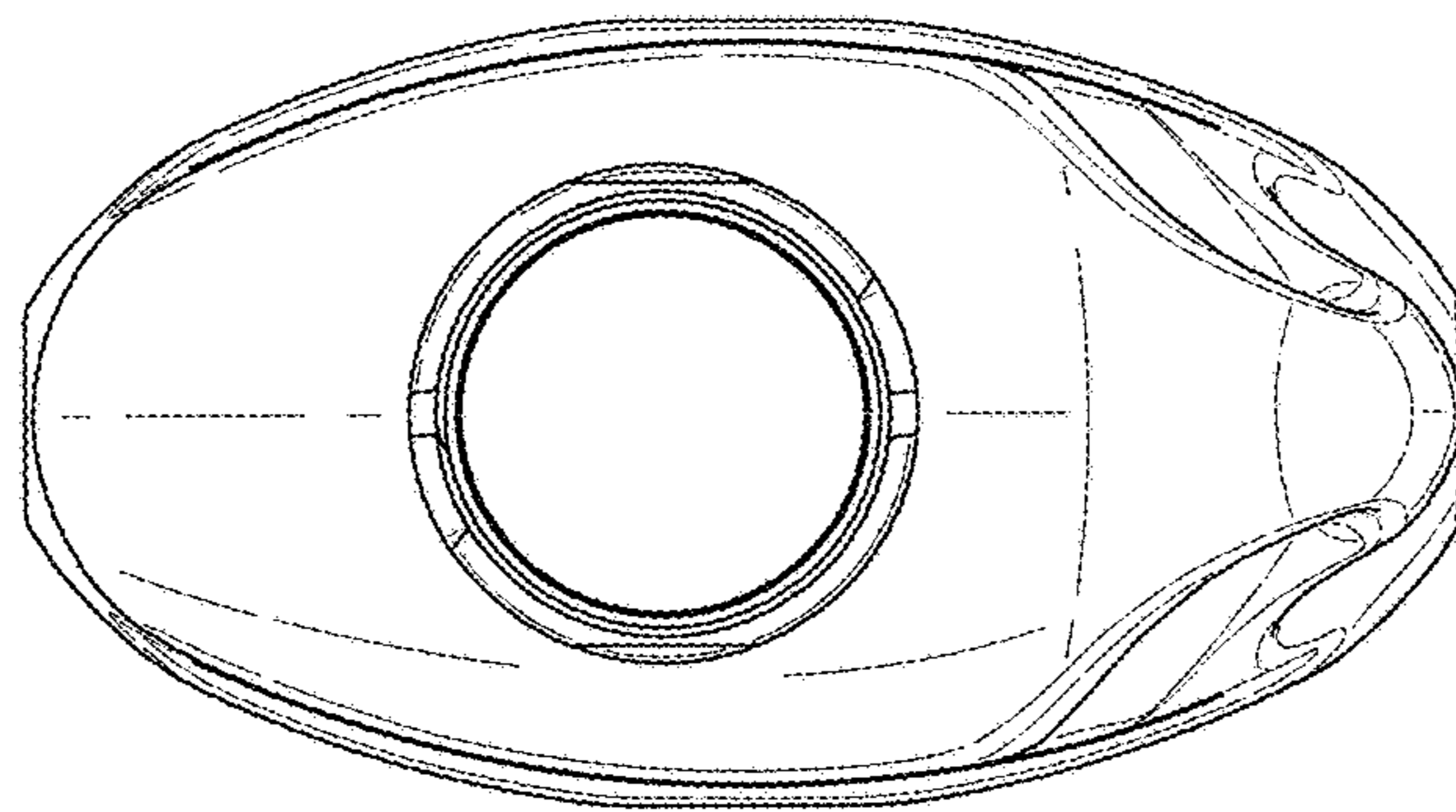

Fig. 6

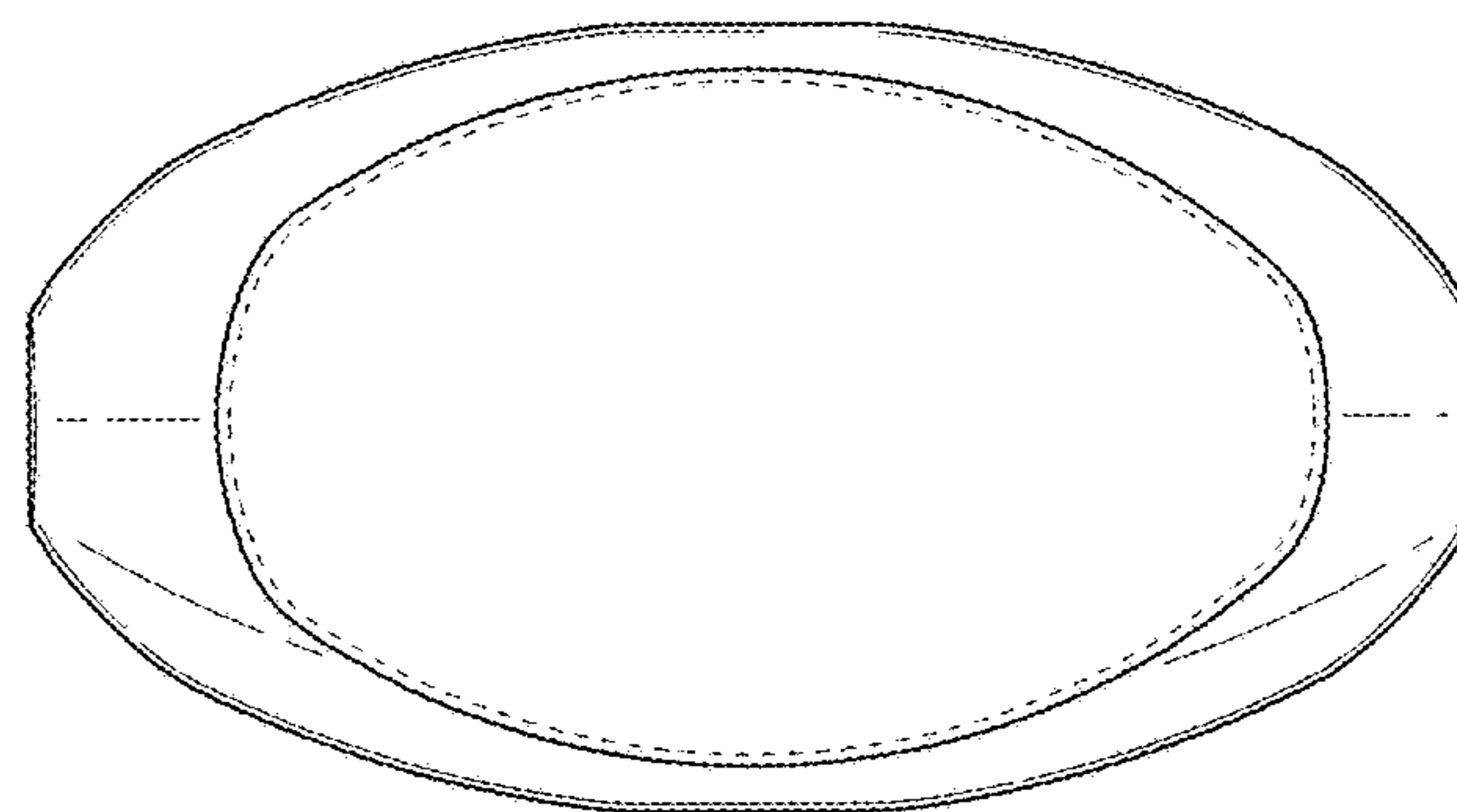

Fig. 7